



HHT082E

Hot holding trolley

CONSTRUCTION FEATURES

- Tightness chamber with radiuses corners
- All-around rubber bumpers
- Total thermic insulation with rock or glass wood
- Long lasting front and door seals made up of food grade of high heat resistance
- Removable side racks to facilitate cleaning
- Static heating provided by low consumption wire heating element that coils up all the chamber
- Ergonomic and fully built-in door handle with magnetic closure
- Mounted on four 125 mm diameter castors, two of which with brake
- Ergonomic handle for pushing and guiding
- Easy access to facilitate maintenance and repair

FUNCTIONAL FEATURES

- Electronic control of the temperature
- Operating temperature 30°-120°C
- Two adjustable humidity vents on the door
- Chamber with safety thermostat

STANDARD SUPPLY

- Removable GN 2/1 and GN 1/1 tray racks

OPTIONS & ACCESSORIES

- Pass-through design

MODULINESRL

Via dell'Industria 11, Z.I. San Giacomo di Veglia 31029 Vittorio Veneto (TV) - ITALY
 tel. +39 0438 5063 - fax +39 0438 912 323 - info@moduline.it - www.moduline.it



moduline

TECHNICAL INSTALLATION DIAGRAM

Electricity
supply cable
inlet



Adjustable vent
for release
of excess
humidity

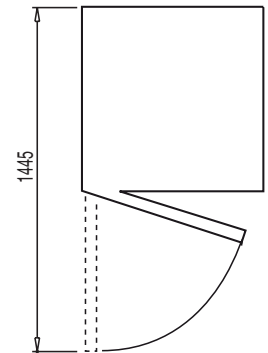
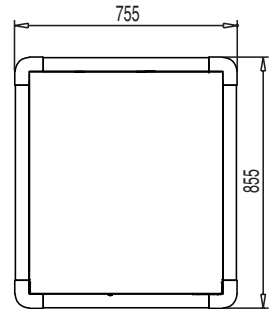
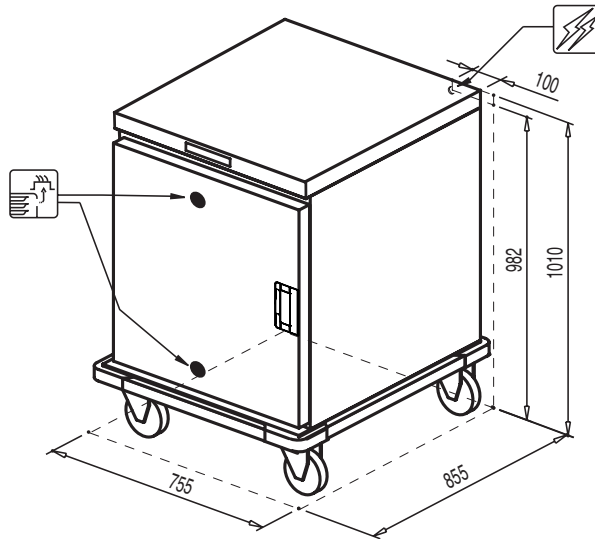

Overall dimensions
(W x D x H) - mm

755 x 855 x 1010

Trays capacity

8 x GN 2/1
16 x GN 1/1

Tray max. height
GN 2/1 [mm]

8 x 65 (h)
3 x 150 (h)
2 x 200 (h) + 2 x 65 (h)

Tray max. height
GN 1/1 [mm]

16 x 65 (h)
6 x 150 (h)
4 x 200 (h) + 4 x 65 (h)

Power kW

1,5

Power supply

AC 230 V / 50 Hz

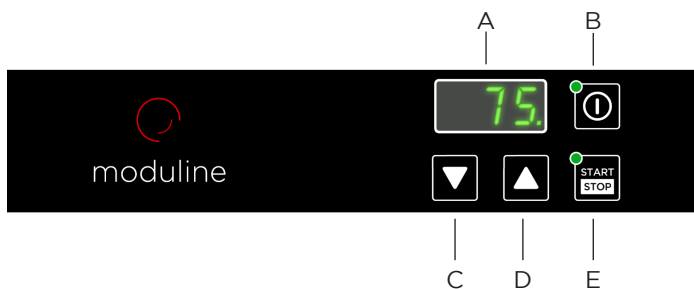

- A Display
- B ON/OFF switch
- C Temperature decrease key
- D Temperature increase key
- E START/STOP key

MODULINESRL

Via dell'Industria 11, Z.I. San Giacomo di Veglia 31029 Vittorio Veneto (TV) - ITALY
tel. +39 0438 5063 - fax +39 0438 912 323 - info@moduline.it - www.moduline.it