

PlateRite HD 8900N-Z/S/E **NEW**

Thermal Plate Recorder

Over 22,000
CtP units
shipped



Creating a Future in Print

New flagship 8-Page Model Delivers Throughput of up to 70 Plates per Hour!

Speed
Efficient production with super-fast output
70 plates* per hour
* Z model

Quality
Remarkable quality
Max. resolution of 4,000 dpi*
* Option for S and E models.

Automation
Improved operability
Autoloading system

Environment
Safe for employees, gentle on environment
Environmentally conscious CtP

Speed

Industry-leading productivity, ideal for rapid turnaround

High-speed output of 70 plates per hour

The high-end PlateRite HD 8900N-Z features a 1,024-channel imaging head that utilizes GLV™ technology and is able to output 70 plates* per hour. Additionally, with A4 size 4-page plates (650 x 550 mm, 25.5" x 21.6"), it is capable of impressive high-speed output of 80 plates per hour. A single PlateRite HD 8900N-Z can also replace output of A4 size 8-page or smaller plates using multiple CtP units. This makes processing easier to manage, and running costs and liquid waste are lower than ever.

The PlateRite HD 8900N-Z delivers the almost instantaneous response required for today's small lots and ultrashort deadlines, providing a new level of added value for clients. The

S and E models also feature a 512-channel imaging head, with respective throughputs of up to 48 and 36 plates per hour.

* At 2,400 dpi, with 1,030 x 800 mm (40.5" x 31.5") plates.

Variety of plate sizes for different presses

The PlateRite HD 8900N series supports plates ranging from 304 x 305 mm (12" x 12.1") to 1,165 x 950 mm (45.8" x 37.4"). Compatibility with 6-mm leading and tailing edge clamps also enables output from a wider variety of presses. Simplified plate setting further improves operating ratios, boosting the productivity delivered by the series' high-speed output.

Quality

Outstanding reproduction, cutting-edge exposure technology

Creation of sharper halftone dots with the latest technology

Use of the latest GLV-equipped exposure heads creates significant improvements in the optical system, producing more uniform distribution of illumination. A high-precision auto-focus mechanism also enables output of SCREEN's proprietary Spekta 2 hybrid screening and Randot X 20 (20 μm) FM screening.*

* For supported plate types

High-resolution, high-quality output

The high-definition S and E models support ultrafine AM halftone dots that provide a maximum resolution of up to 700 lpi. Tuning

also enables output using Randot X 10 (10 μm) FM screening. Together these features deliver the extremely high quality required for detailed output such as art printing.*

All models now also support lenticular output mode, which uses spiral imaging correction to cancel out pixel shift. This mode eliminates the interference moire created by lenticular lenses and is highly effective for the imaging of high-precision straight lines, such as those in microtext and bar codes.

In addition, using either 4,000 or 4,800 dpi mode enables high-resolution output that includes 3D lenticular printing.*

* For supported plate types



175 lpi at 2,400 dpi



700 lpi at 4,000 dpi (print sample)

*Not multi screening



Example of high-end lenticular production

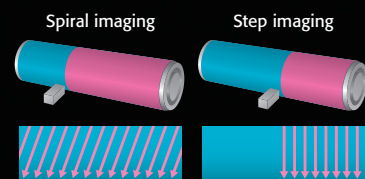

3D lenticular mode specification

PlateRite HD 8900N-Z/S/E

Automation

Autoloader maximizes productivity



An autoloader system can be installed to automate the entire platemaking process, from plate loading through imaging and transport to developing. The autoloader enables extended periods of continuous operation and significantly increases both productivity and press operating ratios.

Loading of plates during processing

The MA-L8900 allows plates to be loaded into the cassette during continuous operation. This avoids downtime when additional plates are required and maximizes productivity and press operating ratios.



The ergonomic design ensures easy operation even when adding plates to cassettes.

MA-L8900 multi-cassette autoloader

The MA-L8900 comes standard with three plate cassettes (up to five as an option) and full automation of both plate supply and cassette switching. Each

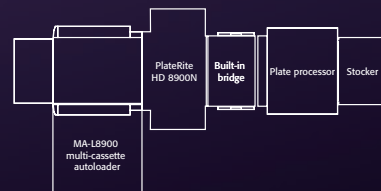

cassette holds up to 100 plates,* for a maximum of 500 plates stored in the autoloader. Even if different plate sizes are loaded into separate cassettes, the autoloader flexibly switches between the cassettes as required. Loading all cassettes with the same plate size enables extended periods of continuous operation. * For 0.3-mm plates

SA-L8900 single-cassette autoloader

The SA-L8900 features a single cassette that holds up to 100 plates*, as well as automatic detection and removal of interleaf paper. Its transport system only contacts the rear side of a plate, preventing damage to the sensitive emulsion side.

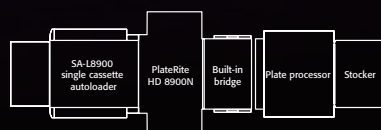

Manual loading is also possible, giving operators the flexibility to select plate sizes as required. * For 0.3-mm plates

Remote monitoring function

• Constant checking of CtP status from a remote location

CtP operating conditions and output history can easily be checked from a remote location via Web browser or email*. An external PC can also be effectively used as a substitute operation panel, allowing users at remote locations to make CtP settings and send commands. In addition, inclusion of a self-diagnosis function allows the confirmation of correct operation of the CtP and autoloader units. This provides straightforward assessment of required parts if a problem occurs, enabling rapid recovery of the equipment. Emails* are also automatically forwarded to a service center,

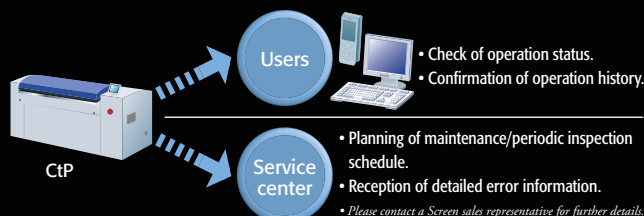

allowing an in-depth understanding of the operation status of the equipment. This information can be used during maintenance, repairs, and periodic inspections, ensuring the system remains in optimal condition at all times (support contract required).

* Can be forwarded to up to five email addresses

• Minimization of plate exchange/replacement times

If an autoloader is connected, the number of plates remaining in the cassettes is monitored in real time. When there are only a few plates left, an instruction to prepare for cassette replacement can be displayed on either the Web browser or operation panel.

As cassettes can be moved to the plate insertion position from a remote location, the time required for plate exchange and replacement is minimized. This contributes to the achievement of an even higher CtP operation rate.



Environment

Gentle on the environment

Screen assesses the environmental impact of all its products as a form of design review. The PlateRite HD 8900N series has been developed with the goals of minimizing energy use and environmental impact while maximizing safety.

- Energy use during operation has been cut by up to 43%.*
- A power-saving mode allows energy savings of up to 88%* during idling.
- The low-impact design conforms to RoHS environmental standards.
- All models are compatible with chemical-less plates from a range of manufacturers.

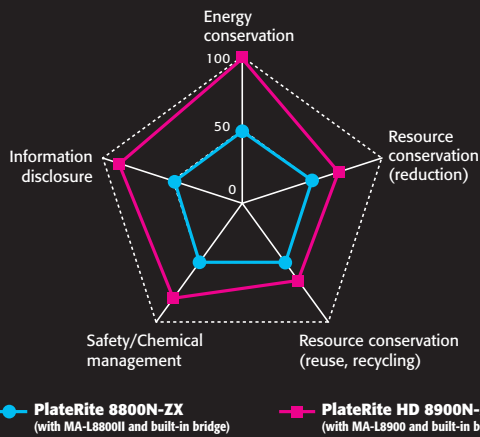

Trends in PlateRite 8000 series electricity consumption (Screen measurements)

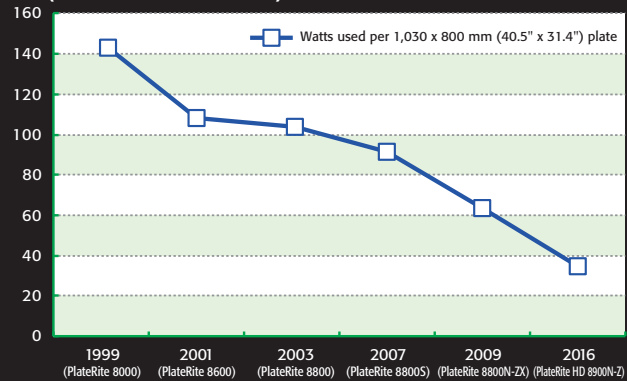

The PlateRite series supports all types of chemical-less plates sold by plate makers. This reduces both the electricity consumption and chemical volume used by the developing unit after imaging as well as the ink volume used when Spekta 2 AM/FM hybrid screening is applied. These features demonstrate the significant progress of Screen's environmental efforts. In addition, the latest PlateRite HD

8900N models for the high-demand A4-8 page size have been developed with even greater emphasis on environmental concerns. With the Z model, power consumption during operation has been reduced by up to 43 percent per plate,* while the installation of a power saving mode decreases power consumption during standby by 88 percent.*

* As power consumption levels are also affected by the operating environment and other external factors, the above values cannot be guaranteed.

Comparison of the PlateRite HD 8900N-Z and PlateRite 8800N-ZX when an MA-L and built-in bridge are connected.

The conditions of a room temperature of 25°C (77°F) and during operation are for a resolution of 2,400 dpi and plate size of 1,030 x 800 mm (40.5" x 31.4").



PlateRite HD 8900N-Z/S/E specifications

Product Name	PlateRite HD 8900N-Z	PlateRite HD 8900N-S	PlateRite HD 8900N-E
Model Name	PT-R8900N-Z	PT-R8900N-S	PT-R8900N-E
Recording system	External drum		
Light source	1,024-channel laser diode	512-channel laser diode	
Plate size	Maximum: 1,165 x 950 mm (45.8" x 37.4"); Minimum: 304 x 305 mm (12" x 12.1")*1		
Exposure size	Maximum: 1,165 x 938 mm (45.8" x 36.9")		
Plate	Thermal aluminum plate		
Plate thickness	0.15 to 0.3 mm (5.9 mil to 11.8 mil) [0.4 mm (15.7 mil)*2 available as an option]		
Resolutions	1,200*3/2,400/2,438/2,540 dpi	1,200*3/2,400/2,438/2,540/4,000 dpi (4,000 dpi is only available when the high resolution option*4 is selected)	
Repeatability	±5 µm*5		
Productivity *6	70 plates/hr at 2,400 dpi (1,030 x 800 mm/40.5" x 31.4" plates) 80 plates/hr at 2,400 dpi (650 x 550 mm/25.5" x 21.6" plates)	48 plates/hr at 2,400 dpi (1,030 x 800 mm/40.5" x 31.4" plates) 64 plates/hr at 2,400 dpi (650 x 550 mm/25.5" x 21.6" plates)	36 plates/hr at 2,400 dpi (1,030 x 800 mm/40.5" x 31.4" plates) 48 plates/hr at 2,400 dpi (650 x 550 mm/25.5" x 21.6" plates)
Interface	Gigabit Ethernet		
Punch systems	Screen, Heidel, Heidelbach W, Protocol, and Komori punch systems are standard; all others are special orders. (Up to twelve individual punch blocks can be selected and mounted as an option, depending on the plate sizes and printing press types being used.)		
Step imaging	Standard	Option (Only available when the high resolution option*4 is selected)	
Dimensions (W x D x H)	Main unit: 2,640 x 1,475 x 1,394 mm (104" x 58.1" x 54.9")(blower unit is internal) Chiller unit: 350 x 720 x 720 mm (13.8" x 28.4" x 28.4")		
Weight	Main unit: 1,115 kg (2,530 lb); Chiller unit: 63 kg (138.6 lb)		
Power requirements	Main unit: Single phase 200 V to 240 V, 16 A, 3.2 kW Chiller unit: Single phase 200 V to 240 V, 4 A, 0.7 kW [SA-L and MA-L are supplied by main unit.]	Main unit: Single phase 200 V to 240 V, 16 A, 3.2 kW Chiller unit*7: Single phase 200 V to 240 V, 3 A, 0.6 kW [SA-L and MA-L are supplied by main unit.]	
Environment	Recommended: 21 to 25°C (69.8 to 77°F); Required: 18 to 26°C (64.4 to 78.8°F); Relative humidity: 40 to 70% (no condensation)		
Required options *8	MA-L8900, SA-L8900, plate insertion table		
Options	Plate transport system to connect with plate processor (built-in bridge, AT-M8001), various printing press punches, support for 0.4 mm (15.7 mil) thickness, high resolution (4,000 dpi support)*4, air filter unit (AF-180N), upgrade to S specifications.		
Applicable standard	Main unit: Approved UL, CSA, Declared CE Chiller unit: Approved UL, CSA, Declared CE		

*1 Plates wider than 590 mm (23.3") and narrower than 610 mm (24") cannot be used. *2 Plates that are 0.4 mm (15.7 mil) thick must be 900 x 770 mm (35.5" x 30.4") or larger.

*3 1,200 dpi uses 2,400 dpi double dots. *4 Option must be selected before the unit is shipped from the factory. *5 Over four consecutive exposures on one plate at 23°C (73.4°F) and 60% relative humidity.

*6 This value is for when an autoloader is connected. Productivity may vary depending on the sensitivity of the plate. *7 The North American specifications may be single phase 200/208/220/230/240 V, 3 A, 1.4 kW.

*8 One of the options must be selected. Consult a Screen representative regarding throughput when the plate insertion table is chosen.

Autoloader specifications

Product Name	SA-L8900	MA-L8900
Compatible models*1	PlateRite HD 8900N-Z/S/E	
No. of cassettes	1	Up to 5 cassettes (3 cassettes as standard)
Cassette capacity	100 plates (0.15 to 0.3 mm thickness) 75 plates (More than 0.3 mm thickness)	100 plates per cassette (0.15 to 0.3 mm thickness) 75 plates per cassette (More than 0.3 mm thickness)
Plate size	Maximum: 1,165 x 950 mm (45.8" x 37.4"); Minimum: 304 x 305 mm (12" x 12.1")	
Plate thickness	0.15 to 0.4 mm (5.9 mil to 15.7 mil)	
Dimensions (W x D x H)	1,827 x 2,351 x 1,530 mm (72" x 92.6" x 60.3")	3,345 x 2,351 x 1,530 mm (131.7" x 92.6" x 60.3")
Weight*2	600 kg (1,320 lb)	1,088 kg (2,393.6 lb)
Power requirements	Supplied by main unit	
Environment	Recommended: 21 to 25°C (69.8 to 77°F); Required: 18 to 26°C (64.4 to 78.8°F); Relative humidity: 40 to 70% (no condensation)	
Options	Additional carrier-type cassette (with dustproof cover) Left layout kit	Additional cassette Left layout(Factory option)

*1. Not supported for the PlateRite 8800N/8600N/8300N. *2. Not including the weight of the plates.



Dimensions

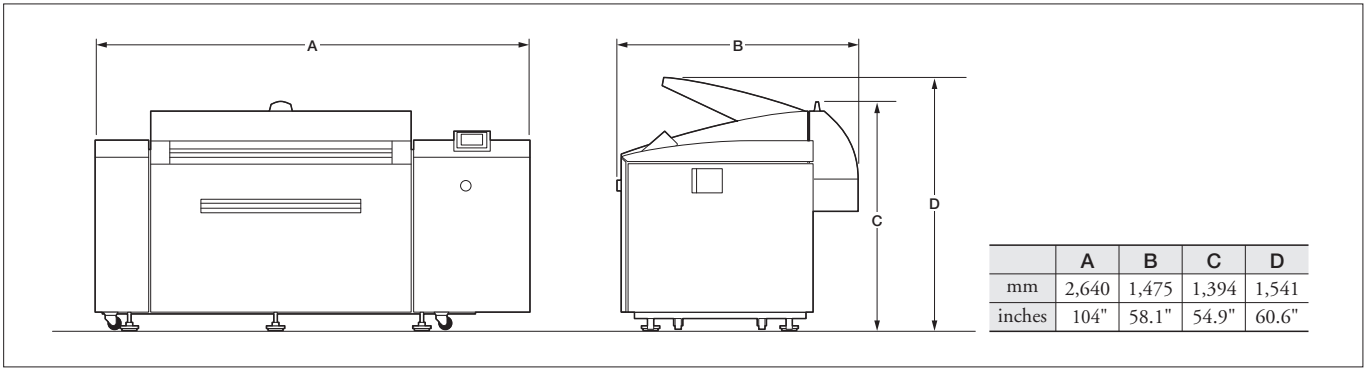

Floor plan

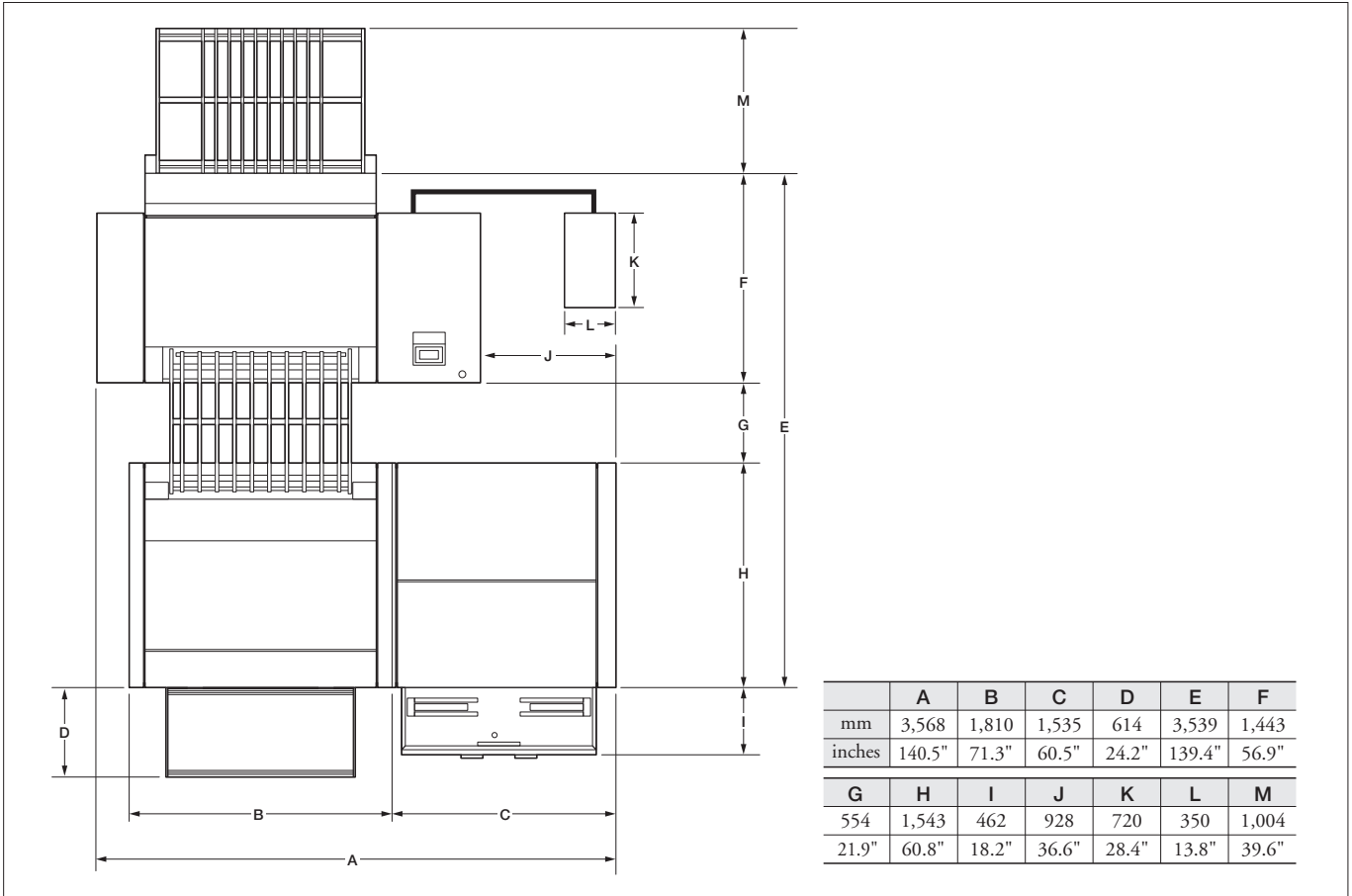

www.screen.co.jp/ctp_no1

For more information, please visit our web site.
You can see product movie on it!



SCREEN Graphic and Precision Solutions Co., Ltd.

HEAD OFFICE

• Tenjinkita-machi 1-1, Teranouchi-agaru 4-chome, Horikawa-dori, Kamigyo-ku, Kyoto 602-8585, Japan / Tel: +81-75-414-7610

SCREEN GP Americas, LLC

• 5110 Tollview Drive, Rolling Meadows, IL 60008, U.S.A. / Tel: +1-847-870-7400 / Fax: +1-847-870-0149 www.screenusa.com

SCREEN GP Europe B.V.

• Bouwerij 46, 1185XX Amstelveen, The Netherlands / Tel: +31-20-456-78-00 / Fax: +31-20-456-78-05 www.screeneurope.com

U.K. office / Tel: +44-1582-72-5400 / Fax: +44-1582-72-5405

SCREEN HD Singapore PTE. Ltd.

• 29, Kaki Bukit View, Kaki Bukit Techpark II, Singapore 415963 / Tel: +65-67493833 / Fax: +65-67499010 www.screensp.com.sg

Indian Liaison office / Tel: +91 22-6673-5088 / Fax: +91 22-6673-5087

SCREEN GP China Co., Ltd.

• Room 2001 - 2003, 20/F Cable TV Tower 9 Hai Shing Road Tsuen Wan, N.T. Hong Kong / Tel: +852-2953-0038 / Fax: +852-2755-8683 www.screenchina.com

Shanghai office / Tel: +86-21-3126-5122 / Fax: +86-21-5218-2199

Beijing office / Tel: +86-10-6708-9271, 9272, 9273 / Fax: +86-10-6708-9395

Guangzhou office / Tel: +86-20-3891-1112 / Fax: +86-20-3891-1036

SCREEN GP Taiwan Co., Ltd.

• 4th Floor, No. 126-1, Min-tsu West Road, Taipei, Taiwan R.O.C. / Tel: +886-2-25862711 / Fax: +886-2-25914367

SCREEN HD Korea Co., Ltd.

• Yonssei Dongrae B/D 10FL, Songrae-Dong, Joong-Gu, Seoul, 100-161, Korea / Tel: +82-2-727-0860 / Fax: +82-2-727-0876 www.screen-korea.com

SCREEN GP Australia PTY., Ltd.

• Suite 11, 2 Eden Park Drive, Macquarie Park, NSW 2133, Australia / Tel: +61-2-9016-3400 / Fax: +61-2-9016-3425 www.screenaustralia.com.au

Internet web site : www.screen.co.jp/gp

www.screenusa.com

www.screeneurope.com

- This brochure was made using SPEKTA 2 screening.



We reserve the right to alter product design and specifications without prior notice.

No.205-177E Printed in Japan 06-16 000PSI(R1-1)