

reddot award 2014
winner

Invacare® Colibri

en Scooter
User Manual



This manual **MUST** be given to the user of the product.
BEFORE using this product, this manual **MUST** be read and saved for
future reference.



Yes, you can.®

© 2021 Invacare Corporation

All rights reserved. Reproduction, duplication or modification in whole or in part is prohibited without prior written permission from Invacare. Trademarks are identified by ™ and ®. All trademarks are owned by or licensed to Invacare Corporation or its subsidiaries unless otherwise noted.

Making Life's Experiences Possible is a registered trademark in the U.S.A.

Contents

1 General	5
1.1 Introduction	5
1.2 Symbols in This Manual	5
1.3 Compliance	5
1.3.1 Product-Specific Standards	6
1.4 Usability	6
1.5 Warranty Information	6
1.6 Service Life	7
1.7 Limitation of Liability	7
2 Safety	8
2.1 General safety notes	8
2.2 Safety Information on the Electrical System	10
2.3 Safety Information on Electromagnetic Interference	12
2.4 Safety information on driving and freewheel mode	13
2.5 Safety information with regard to care and maintenance	15
2.6 Safety information regarding changes and modifications to the mobility device	15
3 Product Overview	17
3.1 Intended Use	17
3.2 Indications	17
3.3 Type classification	17
3.4 Labels on Product	17
3.5 Main Parts of the Scooter	19
3.6 Operating console arrangement	20
3.6.1 Status Display	20
3.6.2 Battery charge display	20
4 Setup	21
4.1 General setup information	21
4.2 Adjusting the armrest width	22
4.3 Adjusting the armrest angle	22
4.4 Replacing armrest pads	23
4.5 Disengaging the seat to rotate it or remove it	23
4.6 Adjusting the seat height	24
4.7 Adjusting the tiller angle	24
4.8 Adjusting Light	25
5 Usage	27
5.1 Getting in and out	27
5.2 Before Driving for First Time	27
5.3 Taking Obstacles	28
5.3.1 Maximum Obstacle Height	28
5.3.2 Safety information when ascending obstacles	28
5.3.3 The correct way to overcome obstacles	28
5.4 Driving up and down gradients	28
5.5 Parking and stationary	29
5.6 Pushing Scooter by Hand	29
5.6.1 Disengaging Motors	29
5.7 Driving the scooter	30
5.8 Using the horn	31
6 Controls System	32
6.1 Electronics Protection System	32
6.1.1 The main fuse	32
6.2 Batteries	32
6.2.1 General Information on Charging	32
6.2.2 General Instructions on Charging	32
6.2.3 How to charge the batteries	33
6.2.4 How to disconnect the batteries after charging	34
6.2.5 Storage and Maintenance	34
6.2.6 Instructions on using the batteries	34
6.2.7 Transporting Batteries	35
6.2.8 General Instructions on Handling Batteries	35
6.2.9 Handling Damaged Batteries Correctly	36
7 Transport	37
7.1 Transport - General information	37
7.2 Dismantling the scooter for transport	37
7.2.1 Removing/Installing the battery box	37
7.2.2 Removing the drive unit	39

7.3	Reassembling the scooter	39
7.4	Transferring Mobility Device to Vehicle	40
7.5	Transporting Mobility Device Without Occupant.	40
8	Maintenance	41
8.1	Maintenance Introduction	41
8.2	Inspection checks	41
8.3	Wheels and Tyres	42
8.4	Short-Term Storage	43
8.5	Long-Term Storage	43
8.6	Cleaning and Disinfection	43
8.6.1	General safety information.	43
8.6.2	Cleaning Intervals.	44
8.6.3	Cleaning	44
8.6.4	Disinfection	45
9	After Use	46
9.1	Reconditioning	46
9.2	Disposal	46
10	Troubleshooting	47
10.1	Diagnosis and fault repair	47
10.1.1	Error diagnosis.	47
10.1.2	Error codes and diagnostic codes	48
10.2	Resetting the circuit breaker	50
11	Technical Data	51
11.1	Technical specifications	51
12	Service.	55
12.1	Inspections Performed.	55

1 General

1.1 Introduction

This user manual contains important information about the handling of the product. To ensure safety when using the product, read the user manual carefully and follow the safety instructions.

Note that there may be sections in this document, which are not relevant to your product, since this document applies to all available models (on the date of printing). If not otherwise stated, each section in this document refers to all models of the product.

The models and configurations available in your country can be found in the country-specific sales documents.

Invacare reserves the right to alter product specifications without further notice.

Before reading this document, make sure you have the latest version. You find the latest version as a PDF on the Invacare website.

If you find that the font size in the printed document is difficult to read, you can download the PDF version from the website. The PDF can then be scaled on screen to a font size that is more comfortable for you.

For more information about the product, for example product safety notices and product recalls, contact your Invacare distributor. See addresses at the end of this document.

In case of a serious incident with the product, you should inform the manufacturer and the competent authority in your country.

1.2 Symbols in This Manual

Symbols and signal words are used in this manual and apply to hazards or unsafe practices which could result in personal injury or property damage. See the information below for definitions of the signal words.



WARNING

Indicates a hazardous situation that could result in serious injury or death if it is not avoided.



CAUTION

Indicates a hazardous situation that could result in minor or slight injury if it is not avoided.



IMPORTANT

Indicates a hazardous situation that could result in damage to property if it is not avoided.



Tips

Gives useful tips, recommendations and information for efficient, trouble-free use.



Tools

Identifies required tools, components and items which are needed to carry out certain work.

1.3 Compliance

Quality is fundamental to the company's operation, working within the disciplines of ISO 13485.

This product features the CE mark, in compliance with the Medical Device Regulation 2017/745 Class I. The launch date of this product is stated in the CE declaration of conformity.

We are continuously working towards ensuring that the company's impact on the environment, locally and globally, is reduced to a minimum.

We only use REACH compliant materials and components.

We comply with the current environmental legislations WEEE and RoHS.

1.3.1 Product-Specific Standards

The product has been tested and conforms to DIN EN 12184 (Electrically powered wheelchairs, scooters and their chargers) and all related standards.

When equipped with an appropriate lighting system, the product is suitable for use on public roads.

For further information about local standards and regulations, contact your local Invacare distributor. See addresses at the end of this document.

1.4 Usability

Only use a mobility device when it is in perfect working order. Otherwise, you might put yourself and others at risk.

The following list does not claim to be exhaustive. It is only intended to show some of the situations that could affect the usability of your mobility device.

In certain situations, you should immediately stop using your mobility device. Other situations allow you to use the mobility device to get to your provider.

You should immediately stop using your mobility device if its usability is restricted due to:

- Unexpected driving behaviour
- brake failure

You should immediately contact an authorised Invacare provider if the usability of your mobility device is restricted due to:

- the lighting system (if fitted) failing or being defective
- reflectors falling off
- worn thread or insufficient tire pressure
- damage to the armrests (e.g. torn armrest padding)
- damage to the legrest hangers (e.g. missing or torn heel straps)
- damage to the postural belt
- damage to the joystick (joystick cannot be moved into the neutral position)
- cables that are damaged, kinked, pinched or have come loose from the fixation
- the mobility device drifting when braking
- the mobility device pulling to one side when moving
- unusual sounds developing or occurring

Or if you have the feeling that something is wrong with your mobility device.

1.5 Warranty Information

We provide a manufacturer's warranty for the product in accordance with our General Terms and Conditions of Business in the respective countries.

Warranty claims can only be made through the provider from whom the product was obtained.

1.6 Service Life

The expected service life of this product is five years when used daily and in accordance with the safety instructions, maintenance intervals and correct use, stated in this manual. The effective service life can vary according to frequency and intensity of use.

1.7 Limitation of Liability

Invacare accepts no liability for damage arising from:

- Non-compliance with the user manual
- Incorrect use
- Natural wear and tear
- Incorrect assembly or set-up by the purchaser or a third party
- Technical modifications
- Unauthorised modifications and/or use of unsuitable spare parts

2 Safety

2.1 General safety notes



DANGER!

Risk of Death, Serious Injury, or Damage

Lighted cigarettes dropped onto an upholstered seating system can cause a fire resulting in death, serious injury, or damage. Mobility device occupants are at particular risk of death or serious injury from these fires and resulting fumes because they may not have the ability to move away from the mobility device.

- DO NOT smoke while using this mobility device.



WARNING!

Risk of Injury, Damage or Death

Improper monitoring or maintenance may cause injury, damage or death due to ingestion or choking on parts or materials.

- Closely supervise children, pets, or people with physical/mental disabilities.



WARNING!

Risk of Serious Injury or Damage

Improper use of this product may cause injury or damage.

- If you are unable to understand the warnings, cautions or instructions, contact a health care professional or provider before attempting to use this equipment.
- Do not use this product or any available optional equipment without first completely reading and understanding these instructions and any additional instructional material such as user manual, service manual or instruction sheet supplied with this product or optional equipment.



WARNING!

Risk of injury if the mobility device is driven when ability to operate a vehicle is impaired by medication or alcohol

- Never drive the mobility device under the influence of medication or alcohol.

**WARNING!****Risk of damage or injury if mobility device is accidentally set into motion**

- Switch off the mobility device before you get in, get out or handle unwieldy objects.
- Be aware that the motor brakes are automatically deactivated when the motors are disengaged. For this reason, freewheel operation is only recommended on flat surfaces, never on gradients. Never leave your mobility device on a gradient with its motors disengaged. Always re-engage the motors immediately after pushing the mobility device.

**WARNING!****Risk of falling out of the mobility device**

- If a posture belt is installed, it should be correctly adjusted and used each time you use the mobility device.

**WARNING!****Risk of Serious Injury or Damage**

Storing or using the mobility device near open flame or combustible products can result in serious injury or damage.

- Avoid storing or using the mobility device near open flame or combustible products.

**WARNING!****Risk of injury if the mobility device is switched off while driving, due to it coming to an abrupt, sharp halt**

- If you have to brake in an emergency, simply release the drive lever and allow the mobility device to come to a complete halt.
- If fitted, pull the handbrake until the mobility device comes to a halt.
- Only switch the mobility device off while in motion as a last resort.

**CAUTION!****Risk of injury if maximum permissible load is exceeded**

- Do not exceed the maximum permissible load (refer to *11 Technical Data, page 51*).
- The mobility device is only designed for use by a single occupant whose maximum weight does not exceed the maximum permissible load of the device. Never use the mobility device to transport more than one person.

**WARNING!****Risk of injury if the mobility device is transported in another vehicle with the occupant seated in it**

- Never transport the mobility device with the occupant seated in it.



CAUTION!

Risk of injury due to wrong lifting or dropping of heavy components

- When maintaining, servicing or lifting any part of your mobility device, take into account the weight of the individual components especially the batteries. Be sure at all times to adopt the correct lifting posture and ask for assistance if necessary.



CAUTION!

Risk of injury by moving parts

- Make sure that no injury is incurred by moving parts of the mobility device, like wheels or a seat lifter (if fitted), especially when children are around.



CAUTION!

Risk of injury from hot surfaces

- Do not leave the mobility device in direct sunlight for prolonged periods. Metal parts and surfaces such as the seat and armrests can become very hot.



CAUTION!

Risk of fire or breaking down due to electric devices being connected

- Do not connect any electric devices to your mobility device that are not expressly certified by Invacare for this purpose. Have all electrical installations done by your authorized Invacare provider.

2.2 Safety Information on the Electrical System



WARNING!

Risk of death, serious injury or damage

- Misuse of the mobility device may cause the mobility device to start smoking, sparking, or burning. Death, serious injury, or damage may occur due to fire.
- DO NOT use the mobility device other than its intended purpose.
 - If the mobility device starts smoking, sparking, or burning, discontinue using the mobility device and seek service IMMEDIATELY.



WARNING!

Risk of fire

- Switched on lamps produce heat. If you cover the lamps with fabrics such as clothes, there is a risk that the fabric may catch fire.
- NEVER cover the light system with fabric.

**WARNING!****Risk of death, serious injury or damage when carrying along oxygen systems**

Textiles and other materials that normally would not burn are easily ignited and burn with great intensity in oxygen enriched air.

- Check the oxygen tubing daily, from the cylinder to the delivery site, for leaks and hold away from electrical sparks and any source of ignition.

**WARNING!****Risk of injury or damage due to electrical shorts**

Connector pins on cables connected to the power module can still be live even when the system is off.

- Cables with live pins should be connected, restrained or covered (with non-conductive materials) so that they are not exposed to human contact or materials that could cause electrical shorts.
- When cables with live pins have to be disconnected, for example, when removing the bus cable from the remote for safety reasons, make sure to restrain or cover the pins (with non-conductive materials).

**WARNING!****Risk of death, serious injury, or damage**

Corroded electrical components due to water or liquid exposure can result in death, serious injury, or damage.

- Minimize exposure of electrical components to water and/or liquids.
- Electrical components damaged by corrosion **MUST** be replaced immediately.
- Mobility devices that are frequently exposed to water/liquids may require replacement of electrical components more frequently.

**WARNING!****Risk of death or serious injury**

Failure to observe these warnings can cause an electrical short resulting in death, serious injury, or damage to the electrical system.

- The POSITIVE (+) RED battery cable MUST connect to the POSITIVE (+) battery terminal(s)/post(s). The NEGATIVE (-) BLACK battery cable MUST connect to the NEGATIVE (-) battery terminal(s)/post(s).
- NEVER allow any of your tools and/or battery cable(s) to contact BOTH battery post(s) at the same time. An electrical short may occur and serious injury or damage may occur.
- Install protective caps on positive and negative battery terminals.
- Replace cable(s) immediately if cable(s) insulation becomes damaged.
- DO NOT remove fuse or mounting hardware from POSITIVE (+) red battery cable mounting screw.

**WARNING!****Risk of death or serious injury**

Electric shock can cause death or serious injury

- To avoid electric shock, inspect plug and cord for cuts and/or frayed wires. Replace cut cords or frayed wires immediately.

**Risk of damage to the mobility device**

A failure in the electric system can lead to unusual behavior such as continuous light, no light, or noises from the magnetic brakes.

- If a failure exists, switch off the remote and switch it on again.
- If a failure still exists, then disconnect or remove the power source. Depending on the mobility device model, you can either remove the battery packs or disconnect the batteries from the power module. If in doubt which cable to disconnect, contact your provider.
- In any case, contact your provider.

2.3 Safety Information on Electromagnetic Interference

This powered mobility device was successfully tested in accordance with International standards as to its compliance with Electromagnetic Interference (EMI) regulations. However, electromagnetic fields, such as those generated by radio and television transmitters, and cellular phones can influence the functions of powered mobility devices. Also, the electronics used in our mobility devices can generate a low level of electromagnetic interference, which however will remain within the tolerance permitted by law. For these reasons we ask you to please observe the following precautions:

**WARNING!****Risk of malfunction due to electromagnetic interference**

- Do not switch on or operate portable transceivers or communication devices (such as radio transceivers or cellular phones) when the mobility device is switched on.
- Avoid getting near strong radio and television transmitters.
- In case the mobility device should be set in motion unintentionally or the brakes are released, switch it off immediately.
- Adding electrical accessories and other components or modifying the mobility device in any way can make it susceptible to electromagnetic interference. Keep in mind that there is no sure way to determine the effect such modifications will have on the overall immunity of the electronic system.
- Report all occurrences of unintentional movement of the mobility device, or release of the electric brakes to the manufacturer.

2.4 Safety information on driving and freewheel mode

**WARNING!****Risk of injury if the mobility device tips over**

- Only ever negotiate gradients up to the maximum safe slope and only with the backrest in an upright position, and the seat lifter in the lowest position (if installed).
- Only ever drive downhill at a maximum of 2/3 of the top speed. Avoid abrupt braking or accelerating on gradients.
- If at all possible, avoid driving on wet, slippery, icy, or oily surfaces (such as snow, gravel, ice etc.) where there is a risk of you losing control over the mobility device, especially on a gradient. This may include certain painted or otherwise treated wood surfaces. If driving on such a surface is inevitable, then always drive slowly and with the utmost caution.
- Never attempt to overcome an obstacle when on an uphill or downhill gradient.
- Never attempt to drive up or down a flight of steps.
- Always approach obstacles straight on. Ensure that the front wheels and rear wheels move over the obstacle in one stroke, do not stop halfway. Do not exceed the maximum obstacle height (refer to *11 Technical Data, page 51*).
- Avoid shifting your center of gravity as well as abrupt changes of direction when the mobility device is in motion.



WARNING!

Risk of injury if the mobility device tips over (continued)

- Never use the mobility device to transport more than one person.
- Do not exceed the maximum permissible load.
- When loading the mobility device, always distribute the weight evenly. Always try to keep the center of gravity of the mobility device in the middle, and as close to the ground as possible.
- Note that the mobility device will brake or accelerate if you change the driving speed while it is in motion.



WARNING!

Risk of injury if you collide with an obstacle when driving through narrow passages such as doorways and entrances

- Drive through narrow passages in the lowest driving speed and with due caution.



WARNING!

The center of gravity of the scooter is higher than that of a power wheelchair.

There is an increased tipping risk when negotiating bends.

- Reduce speed before negotiating bends. Only accelerate when you have come out of the bend.
- Be aware that the seat height strongly influences the center of gravity. The higher the seat height, the higher the risk of tipping.



**WARNING!****Risk of tipping**

Antitippers (stabilizers) are only effective on firm ground. They sink in on soft ground such as grass, snow or mud if the mobility device rests itself on them. They lose their effect and the mobility device can tip over.

- Only drive with extreme care on soft ground, especially during uphill and downhill journeys. In the process pay increased attention to the tip stability of the mobility device.
- Keep in mind that the mobility device as a class A product is mainly for internal use and therefore not necessarily capable of negotiating outdoor obstacles.

2.5 Safety information with regard to care and maintenance

**DANGER!****Risk of death, serious injury, or damage**

Incorrect repair and/or servicing of this wheelchair performed by users/caregivers or unqualified technicians can result in death, serious injury, or damage.

- DO NOT attempt to carry out maintenance work that is not described in this user manual. Such repair and/or service MUST be performed by a qualified technician. Contact a dealer or Invacare technician.

**CAUTION!****Risk of accident and loss of warranty if maintenance is insufficient**

- For reasons of safety and in order to avoid accidents which result from unnoticed wear, it is important that this electric mobility product undergoes an inspection once every year under normal operating conditions (see inspection plan contained in service instructions).
- Under difficult operating conditions such as daily travel on steep slopes, or in the case of use in medical care cases with frequently changing wheelchair users, it would be expedient to carry out intermediate checks on the brakes, accessories and running gear.

2.6 Safety information regarding changes and modifications to the mobility device

**CAUTION!****Risk of serious injury or damage**

Use of incorrect or improper replacement (service) parts may cause injury or damage

- Replacement parts MUST match original Invacare parts.
- Always provide the serial number of the mobility device to assist in ordering the correct replacement parts.



CAUTION!

Risk of injuries and damage to mobility device due to unapproved components and accessory parts

Seating systems, additions and accessory parts which have not been approved by Invacare for use with this mobility device can affect the tipping stability and increase tipping hazards.

- Only ever use seating systems, additions and accessory parts which have been approved by Invacare for this mobility device.

Seating systems which are not approved by Invacare for use with this mobility device do not, under certain circumstances, comply with the valid standards and could increase the flammability and the risk of skin irritation.

- Only use seating systems that have been approved by Invacare for this mobility device.

Electrical and electronic components which have not been approved by Invacare for use with this mobility device can cause fire hazards and lead to electromagnetic damage.

- Only ever use electrical and electronic components which have been approved by Invacare for this mobility device.

Batteries which have not been approved by Invacare for use with this mobility device can cause chemical burns.

- Only ever use batteries which have been approved by Invacare for this mobility device.



CE marking of the mobility device

- The conformity assessment/CE marking was carried out in accordance to the respective valid regulations and only applies to the complete product.
- The CE marking is invalidated if components or accessories are replaced or added that have not been approved for this product by Invacare.
- In this case, the company that adds or replaces the components or accessories is responsible for the conformity assessment/CE marking or for registering the mobility device as a special design and for the relevant documentation.



Important information about maintenance work tools

- Some maintenance work which is described in this manual and can be carried out by the user without problems require the correct tools for proper work. If you do not have the correct tool available we do not recommend that you try to carry out the relevant work. In this case, we urgently recommend that you contact an authorized specialist workshop.

3 Product Overview

3.1 Intended Use

This mobility device was designed for persons whose ability to walk is impaired, but who are still in terms of their eyesight and physically and mentally able to operate an electric mobility device.

3.2 Indications

The use of a scooter is advisable for persons:

- whose ability to walk is impaired, or
- whose balance is impaired, or
- who cannot walk long distances, or
- who cannot drive vehicles such as cars, bikes or mopeds.

The user must have enough upper body strength to sit on a scooter seat. The user must be able to properly operate an electromotive drive unit.

Contraindications

There are no contraindications known.

3.3 Type classification

This vehicle has been classified according to EN 12184 as a **class A mobility product**. This means it is a compact, manoeuvrable vehicle mainly for internal use with restricted capabilities for one or more of the following features in outdoor areas:

- rated slope (3 degrees)

- obstacle climbing (15 mm)
- lighting (no light option)
- drive range (15 km)
- ground clearance (10 mm)

The values in parentheses name the minimum requirements of a class A product. For the maximum possible values of this mobility device, see *11 Technical Data, page 51*.

3.4 Labels on Product

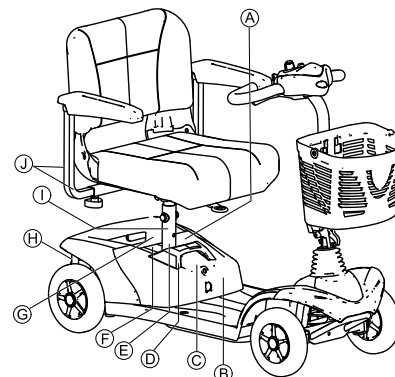

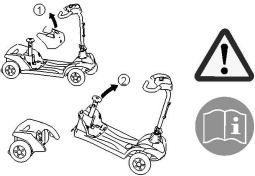





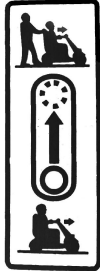















Fig. 3-1

A		<p>Pull battery box latch to front to release battery box for removing</p>
B		<p>Quick info how to disassemble scooter. Read user manual for more information.</p>
C		<p>Voltage warning sign label Battery label under shroud</p>
D		<p>Possible pinch point at seat post when battery box is removed</p>
E		<p>European representative label on seat post or direct on identification label.</p>
F		<p>WEEE Conformity</p>

G		<p>Drive unit warning sign label</p>
H		<p>Disengaging lever label indicating “Push” and “Drive” position of lever</p>
I		<p>Identification label sticker on seat post. For details see below.</p>
J		<p>Indication of maximum width to which armrest can be set</p>
K		<p>The mobility device is a class A product. It is intended mainly for internal use and not necessarily capable of negotiating outdoor obstacles.</p>

Explanation of Symbols on Labels

	Manufacturer
	Date of manufacture
	This symbol indicates the “Drive” position of the coupling lever. In this position the motor is engaged and the motor brakes are operational. You can drive the mobility device.
	This symbol indicates the “Push” position of the coupling lever. In this position the motor is disengaged and the motor brakes are not operational. The mobility device can be pushed the wheels turn freely.
	European Conformity
	Medical device
 ISO 7176-19	The product needs to be tied down at indicated tie-down points with a lashing system during transport.

 ISO 7176-19	Warning that the mobility device may not be used as a vehicle seat. This mobility device does not satisfy the requirements of ISO 7176-19.
	Caution
	See above

3.5 Main Parts of the Scooter

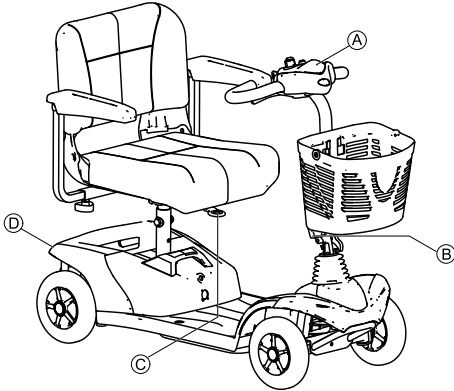

(A)	Operating console
(B)	Lever for adjusting inclination of steering column

Ⓒ	Unlocking lever for swivelling and removing seat (front below seat)
Ⓓ	Disengaging lever

3.6 Operating console arrangement

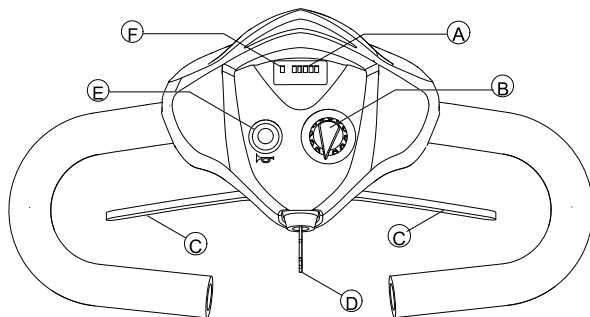

Ⓐ	Battery charge display
Ⓑ	Speed controller
Ⓒ	Drive lever
Ⓓ	Keyswitch (ON/OFF)
Ⓔ	Horn
Ⓕ	Status display / ON/OFF diode

3.6.1 Status Display



The ON/OFF diode is used as a fault display (status display). It will flash if there is a problem with the scooter. The number of flashes indicates the type of error. Refer to *10.1.2 Error codes and diagnostic codes, page 48*.

3.6.2 Battery charge display

All diodes illuminate:	Maximum driving range
Only red and yellow diodes illuminate:	Reduced driving range. Recharge the batteries at the end of your journey.
Only red LEDs illuminate/blink, electronic beeps 3x:	Battery reserve = severely restricted driving range. Recharge batteries immediately!



Overdischarge protection: after a certain drive time on reserve battery power the electronics system switches the drive off automatically and brings your Scooter to a standstill. If you do not drive your Scooter for a while the batteries will "recuperate" and allow a further, but short, journey. However, after a very brief journey the red diodes will illuminate again and the electronic system will beep three times. This procedure leads to battery damage and should be avoided if possible!

4 Setup

4.1 General setup information



WARNING!

Risk of death, serious injury, or damage

Continued use of the mobility device that is not set to the correct specifications may cause erratic behavior of the mobility device resulting in death, serious injury, or damage.

- Performance adjustments should only be made by professionals of the healthcare field or persons fully conversant with this process and the driver's capabilities.
- After the mobility device has been set-up/adjusted, check to make sure that the mobility device performs to the specifications entered during the set-up procedure. If the mobility device does not perform to specifications, IMMEDIATELY turn the mobility device Off and re-enter set-up specifications. Contact Invacare, if mobility device still does not perform to correct specifications.



WARNING!

Risk of death, serious injury, or damage

Attaching hardware that is loosely secured or missing could cause instability resulting in death, serious personal injury, or property damage.

- After ANY adjustments, repair or service and before use, make sure that all attaching hardware is present and tightened securely.



WARNING!

Risk of injury or damage

Incorrect set up of this mobility device performed by users/caregivers or unqualified technicians can result in injury or damage.

- DO NOT attempt to set up this mobility device. Initial set up of this mobility device MUST be performed by a qualified technician.
- Adjustment by the user is only recommended after they have been given appropriate guidance by the healthcare professional.
- DO NOT attempt to carry out the work if you do not have the listed tools available.





CAUTION!

Damage to mobility device and accident hazard

It is possible that collisions can occur between mobility device components due to various combinations of adjustment options and their individual settings

- The mobility device is fitted with an individual, multiply adjustable seating system including adjustable legrests, armrests, a headrest or other options. These adjustment options are described in the following chapters. They are used to adapt the seat to the physical requirements and the condition of the user. When adapting the seating system and the seat functions to the user, ensure that no mobility device components collide.

 Initial setup should always be done by a healthcare professional. Adjustment by the user is only recommended after they have been given appropriate guidance by the healthcare professional.

 Note that there may be sections in this user manual, which are not relevant to your product, since this manual applies to all existing modules (on the date of printing).

4.2 Adjusting the armrest width



WARNING!

Serious injury hazard if one of the armrests falls out of its bracket because they have been adjusted to a width which exceeds the permissible value

- The width adjustment is fitted with small stickers with markings and the word "STOP". The armrests must never be pulled out further than the point at which the word "STOP" is completely legible.
- Always tighten the fixing screws properly once adjustments have been completed.

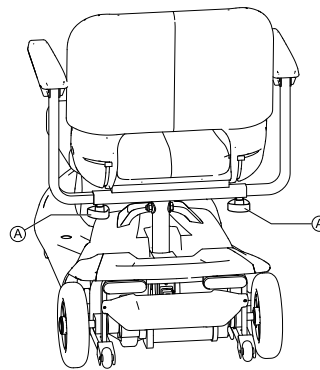

The knobs for releasing the armrests are located under the seat .

1. Turn the knobs to loosen the fixing for the armrest.
2. Adjust the armrests to the required width.
3. Retighten the knobs.

4.3 Adjusting the armrest angle



CAUTION!

Pinch point may occur when adjusting the arm angle

- Pay attention to your fingers.



- 1/2" open-ended wrench

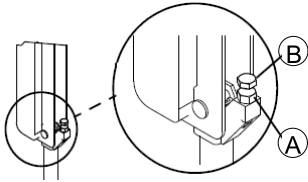

1. Lift up the armrest.
2. Loosen the jam nut (A).
3. Adjust the socket screw (B) up or down to the desired arm angle position.
4. Tighten the jam nut.
5. To determine the same angle for the opposite armrest, count the exposed threads after the jam nut has been tightened.
6. Repeat STEPS 1-4 for opposite armrest, if necessary.

4.4 Replacing armrest pads

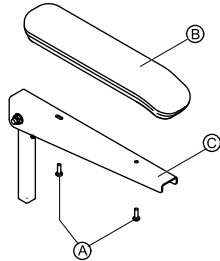

1. Remove the two mounting screws (A) that secure the armrest pad (B) to the arm (C).
2. Remove the old armrest pad.

3. Install the new armrest pad and securely tighten with the existing mounting screws.
4. If necessary, repeat STEPS 1-3 to replace the other armrest pad.

4.5 Disengaging the seat to rotate it or remove it

The seat can be turned to one side to make getting in and out of the scooter easier. The seat is also easier to remove from this position.

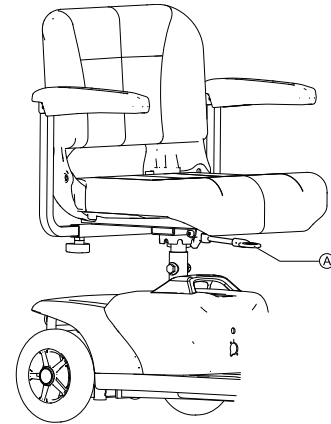

The seat lever (A) is located under the seat in the front.

Rotating the seat

1. Pull the lever upwards to disengage the seat.
2. Turn the seat to the side.

Removing the seat

1. Pull the lever upwards to disengage the seat.
2. Hold the seat firmly by the backrest and front edge and remove it upwards.

Installing the seat

1. Lower the seat assembly onto the seat post.
2. Allow the seat to drop into the locked position.
3. Lift up on the seat assembly to ensure the seat is secure.

4.6 Adjusting the seat height

The seat height can be adjusted to 390, 410, or 430 mm.



Requirements:

- 2 x open-ended spanners 17 mm

1. Remove the seat.
- 2.

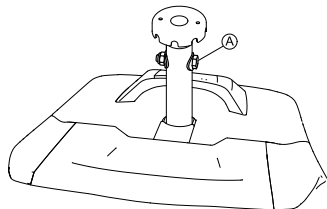

Remove the seat post locking bolt (A) using both open-ended spanners.

3.



Adjust the seat height.

4. Replace the securing bolt and tighten.

4.7 Adjusting the tiller angle



WARNING!

Risk of injury if tiller is not locked into position

- Ensure that the tiller is properly adjusted before driving the scooter.
- After making any tiller angle adjustments and before use, the tiller **MUST** be securely locked into position. Otherwise, a fall from the scooter could occur causing bodily injury and/or damage to the scooter. Gently, push/pull against tiller to ensure that the tiller is securely engaged into the adjustment plate.

The tiller locks into one of three positions. The tiller can also be folded down for transportation and storage.

Adjusting the tiller angle

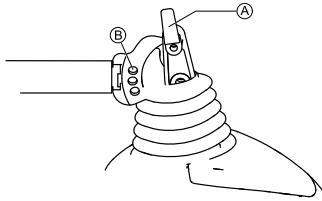

1. Rotate or pull out the tiller adjustment lever (A) until the pin disengages from the mounting hole.
2. Move the tiller to the desired position.
3. Release or rotate the tiller adjustment lever to lock the pin into the desired mounting hole (B).
4. Gently push/pull against tiller to ensure that the tiller is securely locked.

Folding down the tiller

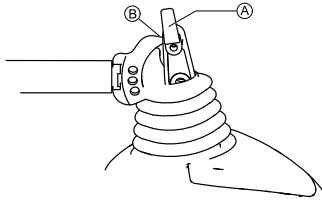

1. Rotate or pull out the tiller adjustment lever (A) until the pin disengages from the mounting hole.
2. Fold down the tiller.
3. Release or rotate the tiller adjustment lever to lock the pin above the tiller base (B).
4. Gently push/pull against tiller to ensure that the tiller is securely locked.

You can now use the tiller as a handle to transport the front frame assembly:

1576371-D

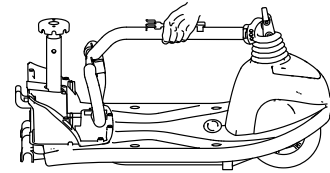

4.8 Adjusting Light

If your mobility device is fitted with optional light, refer to the user manual of the lights for information about usage.



The light must be used in bad visibility conditions like darkness or fog.

Mounting Positions

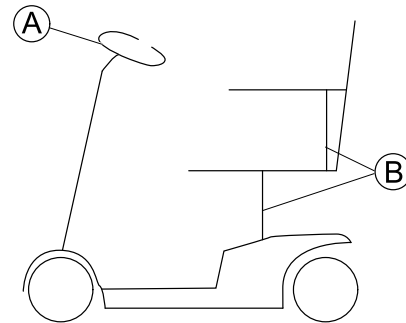

Fig. 4-1 Mounting positions

- (A) Headlight
- (B) Rear Light

Adjusting Headlight

Before first usage you have to adjust the headlight to prevent safety issues. Adjust the headlight so that you are seen well but do not dazzle other traffic.

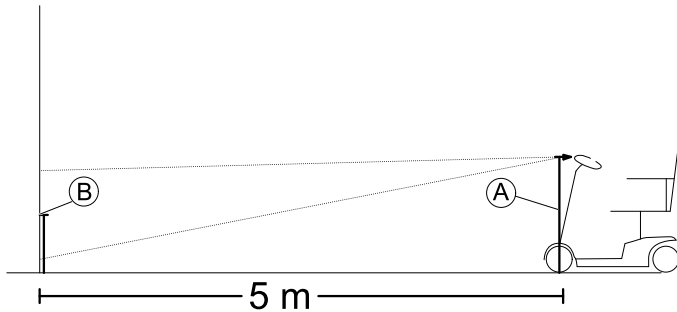
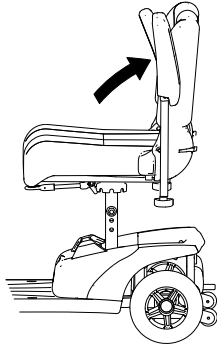

Fig. 4-2

1. Adjust headlight straight ahead.
2. Measure distance between middle of headlight and floor (A).
3. Mark vertical surface, for example, a wall, which corresponds to half of determined value (A).
4. Distance between marking (B) and headlight must be five meters.
5. Adjust middle of light cone to marking (B).

5 Usage

5.1 Getting in and out



The armrests can be swivelled upwards to assist getting in and out.

The seat can also be rotated to assist getting in and out.

1.

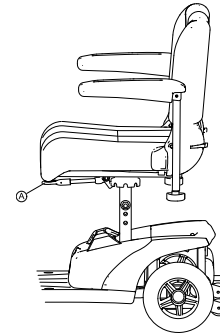

Lift the detent lever (A) up.

2.

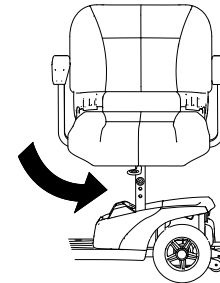

Turn the seat to the side.



Information on turning the seat

- The detent automatically engages again in eighth-turns.

5.2 Before Driving for First Time

Before you take your first trip, you should familiarise yourself well with the operation of the mobility device and with all

operating elements. Take your time to test all functions and driving modes.



If installed, make sure to properly adjust and use the posture belt each time you use the mobility device.

Sitting comfortably = Driving safely

Before each trip, make sure that:

- You are within easy reach of all operating controls.
- The battery charge is sufficient for the distance you intend to travel.
- The posture belt (if installed) is in perfect order.
- The rear mirror (if installed) is adjusted so you can look behind at all times without having to bend forward or shift your seating position.

5.3 Taking Obstacles

5.3.1 Maximum Obstacle Height

You can find information about maximum obstacle heights in the chapter entitled *11 Technical Data, page 51*.

5.3.2 Safety information when ascending obstacles



WARNING!

Risk of tipping over

- Never approach obstacles at an angle but at 90 degrees as shown below.
- Put your backrest into an upright position before climbing an obstacle.

5.3.3 The correct way to overcome obstacles

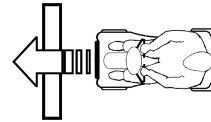

Fig. 5-1 Right

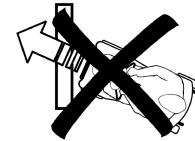

Fig. 5-2 Wrong

Driving up over an obstacle

1. Approach the curb or obstacle slowly head-on. Shortly before the front wheels touch the obstacle, increase the speed and reduce only after the rear wheels have also climbed the obstacle.

Driving down off of an obstacle

1. Approach the curb or obstacle slowly head-on. Before the front wheels touch the obstacle, reduce speed and keep it until also the rear wheels have come down off of the obstacle.

5.4 Driving up and down gradients

For information concerning the rated slope, refer to *11 Technical Data, page 51*.

**WARNING!****Risk of tipping over**

- Only ever drive downhill at a maximum of 2/3 of the top speed.
- If your scooter is fitted with an adjustable backrest, always return the backrest of your seat to an upright position before ascending slopes. We recommend that you lean the backrest slightly to the rear before descending slopes.
- When descending slopes, bring your seat to a maximum forward position.
- Never attempt to ascend or descend a slope on slippery surfaces or where there is a danger of skidding (such as wet pavement, ice etc).
- Avoid trying to get out of the scooter on an incline or a gradient.
- Always drive in a straight direction along the road or path you are travelling on, rather than attempting to zigzag.
- Never attempt to turn around on an incline or a slope.

**CAUTION!****Braking distance is much longer on a downhill slope than on even terrain**

- Never drive down a slope that exceeds the rated slope (refer to *11 Technical Data, page 51*).

5.5 Parking and stationary

If you park your vehicle, or leave it idle or unattended for a longer period:

1. Switch off the power supply (keyswitch) and remove key.

5.6 Pushing Scooter by Hand

The motors of the scooter are fitted with automatic brakes, preventing the scooter from rolling away out of control when the power supply is turned off. When pushing the scooter, the magnetic brakes must be disengaged.

5.6.1 Disengaging Motors**CAUTION!****Risk of the vehicle running away**

- When the motors are disengaged (for push operation whilst freewheeling), the electromagnetic motor brakes are deactivated. When the vehicle is parked, the levers for engaging and disengaging the motors must without fail be locked firmly into the "DRIVE" position (electromagnetic motor brakes activated).

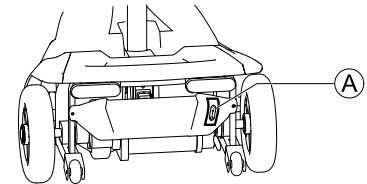

The lever for engaging and disengaging the motor is located on the right-hand side at the rear.

Disengaging the drive

1. Switch off the scooter (keyswitch).
2. Pull the disengaging lever  up.
The drive is now disengaged.

Engaging the drive

1. Push the disengaging lever  down.
The drive is now engaged.

5.7 Driving the scooter



WARNING!

Risk of injury from the unintended rolling of the vehicle

When stopping the vehicle, the drive lever needs to return entirely to the middle position to activate the electromagnetic brakes. If there is any obstruction stopping the lever from returning to the middle position, the electromagnetic brakes cannot be activated. This can lead to the vehicle rolling unintentionally.

- Ensure that the drive lever is in the middle position, if the vehicle is to remain stationary.

1. Switch the power supply on (keyswitch).
The operating console display illuminates. The scooter is ready to drive.



If the scooter is not ready to drive after switching on, check the status display (refer to *3.6.1 Status Display, page 20* and chapter *10.1 Diagnosis and fault repair, page 47*).

2. Set the required speed with the speed controller.
3. Pull the right-hand drive lever carefully to travel forwards.
4. Pull the left-hand drive lever carefully to travel in reverse.



The control system is programmed with standard values in the works. Your Invacare dealer can carry out programming tailored to fit your requirements.



WARNING!

Any changes to the drive program can affect the driving characteristics and the tipping stability of the vehicle.

- Changes to the drive program may only be carried out by trained Invacare specialist dealers.
- Invacare supplies all mobility products with a standard drive program ex-works. Invacare can only give a warranty for safe vehicle driving behavior - especially the tipping stability - for this standard drive program.

-  To brake quickly, simply let go of the drive lever. It will then automatically return to the middle position. The scooter will brake.

5.8 Using the horn



1.  Press the horn key.

An acoustic signal sounds.

6 Controls System

6.1 Electronics Protection System

The scooter electronics is fitted with an overload protection.

If the drive is severely overloaded over a long period of time (for example, when driving up a steep hill) and especially when the ambient temperature is high, the electronic system could overheat. In this case the scooter performance is gradually reduced until it comes to a halt. The status display shows a corresponding error code (refer to *Error Codes And Diagnostic Codes*). By switching the power supply off and back on again, the error code is cleared and the electronics is switched back on. It can however take up to five minutes until the electronics has cooled down enough for the drive to restore full performance again.

If the drive is stalled by an insurmountable obstacle, for example, a curb or similar which is too high, and the driver attempts driving for more than 20 seconds against this obstacle, the electronics automatically switches off to prevent the motors from being damaged. The status display shows a corresponding error code (refer to *Error Codes And Diagnostic Codes*). By switching off and back on again, the error code is cleared and the electronics is switched back on.

6.1.1 The main fuse

The entire electrical system is protected against overload by two main fuses. The main fuses are mounted on the positive battery cables.



A defective main fuse may be replaced only after checking the entire electrical system. A specialized Invacare provider must perform the replacement. You can find information on the fuse type in *11 Technical Data, page 51*.

6.2 Batteries

Power is supplied by two 12 V batteries. The batteries are maintenance-free and only need regular charging.

In the following, you find information on how to charge, handle, transport, store, maintain, and use batteries.

6.2.1 General Information on Charging

New batteries should always be fully charged once before their first use. New batteries will be at their full capacity after having run through approx. 10 - 20 charging cycles (break-in period). This break-in period is necessary to fully activate the battery for maximum performance and longevity. Thus, range and running time of your mobility device could initially increase with use.

Gel/AGM lead acid batteries do not have a memory effect as NiCd batteries.

6.2.2 General Instructions on Charging

Follow the instructions listed below to ensure safe use and longevity of the batteries:

- Charge 18 hours prior to initial usage.

- We recommend charging the batteries daily after every discharge even after partly discharge, as well as each night over night. Depending on the level of discharge, it can take up to 12 hours until the batteries are fully charged again.
- When the battery indicator reached the red LED range, charge the batteries for 16 hours minimum, neglecting the charge complete display!
- Try to provide a 24 hour charge once a week to make sure that both batteries are fully charged.
- Do not cycle your batteries at a low state of charge without regularly recharging them fully.
- Do not charge your batteries under extreme temperatures. High temperatures above 30 °C are not recommended for charging as well as low temperatures below 10 °C.
- Use only charging devices in Class 2. This class of chargers may be left unattended during charging. All charging devices which are supplied by Invacare comply with these requirements.
- You cannot overcharge the batteries when using the charger supplied with your mobility device, or a charger that has been approved by Invacare.
- Protect your charger from sources of heat such as heaters and direct sunlight. If the battery charger overheats, charging current will be reduced and the charging process delayed.

6.2.3 How to charge the batteries

1. Make sure you read and understand the battery charger's user manual, if supplied, as well as the safety notes on the front and rear panels of the charger.



WARNING!

Risk of explosion and destruction of batteries if the wrong battery charger is used

- Only ever use the battery charger supplied with your vehicle, or a charger that has been approved by Invacare.
- Never charge 12 Ah batteries with a 5 A battery charger. Always use a 2 Ah battery charger.



WARNING!

Risk of electric shock and damage to the battery charger if it gets wet

- Protect the battery charger from water.
- Always charge in a dry environment.



WARNING!

Risk of short circuit and electric shock if the battery charger has been damaged

- Do not use the battery charger if it has been dropped or damaged.



WARNING!

Risk of electric shock and damage to the batteries

- NEVER attempt to recharge the batteries by attaching cables directly to the battery terminals.

**WARNING!**

Risk of fire and electric shock if a damaged extension cable is used

- Only ever use an extension cable if it is absolutely necessary. In case you must use one, make sure it is in good condition.

**WARNING!**

Risk of injury if using the wheelchair during charging

- DO NOT attempt to recharge the batteries and operate the wheelchair at the same time.
- DO NOT sit in the wheelchair while charging the batteries.

The charging socket is located under the seat

1. Switch off the scooter.
2. Fold up the charging socket protective cap.
3. Connect the battery charger to the scooter.
4. Connect the battery charger to the power supply.

6.2.4 How to disconnect the batteries after charging

1. Disconnect the battery charger from the power supply.
2. Disconnect the battery charger from the scooter.
3. Close the charging socket protective cap.

6.2.5 Storage and Maintenance

Follow the instructions listed below to ensure safe use and longevity of the batteries:

- Always store the batteries fully charged.

- Do not leave the batteries in a low state of charge for an extended length of time. Charge a discharged battery as soon as possible.
- In case your mobility device is not used for a longer period of time (that is more than two weeks), the batteries must be charged at least once a month to maintain a full charge and always be charged before use.
- Avoid hot and cold extremes when storing. We recommend to store batteries at a temperature of 15 °C.
- Gel and AGM batteries are maintenance-free. Any performance issues should be handled by a properly trained mobility device technician.

6.2.6 Instructions on using the batteries

**CAUTION!**

Risk of damaging the batteries.

- Avoid ultra-deep discharges and never drain your batteries completely.

- Pay attention to the Battery Charge Indicator! Charge the batteries when the Battery Charge Indicator shows that battery charge is low. How fast the batteries discharge depends on many circumstances, such as ambient temperature, condition of the surface of the road, tyre pressure, weight of the driver, way of driving and utilisation of lighting.
- Try to charge the batteries always before you reach the red LED range. The last 2 LED (one red and one orange) mean a remaining capacity of 20 — 30 %.

- Driving with blinking red LED means an extreme stress for the battery and should be avoided under normal circumstances.
- When only one red LED is blinking, the Battery Safe feature is enabled. From this time, speed and acceleration is reduced drastically. It will allow you to move the mobility device slowly out of a dangerous situation before the electronic finally cuts off. This is deep discharging and should be avoided.
- Be aware that for temperatures below 20 °C, the nominal battery capacity starts to decline. For example, at -10 °C the capacity is reduced to about 50 % of the nominal battery capacity.
- To avoid damaging the batteries, never allow them to be fully discharged. Do not drive on heavily discharged batteries if it is not absolutely necessary, as this will strain the batteries unduly and shorten their life expectancy.
- The earlier you recharge the batteries, the longer they live.
- The depth of discharge affects the cycle life. The harder a battery has to work, the shorter is its life expectancy. Examples:
 - One deep discharge stresses the same as 6 normal cycles (green /orange display off).
 - The battery life is about 300 cycles at 80 % discharge (first 3 LED off), or about 3000 cycles at 10 % discharge.
- Under normal operation, once a month the battery should be discharged until all green and orange LED are off. This should be done within one day. A 16 hour charge afterwards is necessary as reconditioning.

6.2.7 Transporting Batteries

The batteries supplied with your mobility device are not hazardous goods. This classification is based on the German GGVS Hazardous Goods Road Transport Ordinances, and the IATA/DGR Hazardous Goods Rail Transport / Air Transport Ordinances. Batteries may be transported without restrictions, whether by road, rail or by air. Individual transport companies have, however, guidelines which can possibly restrict or forbid certain transport procedures. Please ask the transport company regarding each individual case.

6.2.8 General Instructions on Handling Batteries

- Never mix and match different battery manufactures or technologies, or use batteries that do not have similar date codes.
- Never mix gel with AGM batteries.
- The batteries reach their end of life when the drive range is significantly smaller than usual. Contact your provider or service technician for details.
- Always have your batteries installed by a properly trained mobility device technician or a person with adequate knowledge. They have the necessary training and tools to do the job safely and correctly.

6.2.9 Handling Damaged Batteries Correctly



CAUTION!

Corrosion and burns from acid leakage if batteries are damaged

– Remove clothes that have been soiled by acid immediately.

After contact with skin:

– Immediately wash affected area with lots of water.

After contact with eyes:

– Immediately rinse eyes under running water for several minutes; consult a physician.

- Always wear safety goggles and appropriate safety clothing when handling damaged batteries.
- Place damaged batteries in an acid-resistant receptacle immediately after removing them.
- Only ever transport damaged batteries in an appropriate acid-resistant receptacle.
- Wash all objects that have come into contact with acid with lots of water.

Disposing of Dead or Damaged Batteries Correctly

Dead or damaged batteries can be given back to your provider or directly to Invacare.

7 Transport

7.1 Transport - General information



WARNING!

Risk of severe or fatal injuries in the event of a traffic accident if this mobility device is used as a vehicle seat! It does not fulfill the requirements of ISO 7176-19.

- Under no circumstances should this mobility device be used as a vehicle seat or to transport the user in a vehicle.



WARNING!

Risk of death or serious injury to the mobility device user and potentially any other nearby occupant of the vehicle, if a mobility device is secured using a 4-point tie-down system available from a third party supplier and the unladen weight of the mobility device exceeds the maximum weight for which the tie-down system is certified.

- Make sure the weight of the mobility device does not exceed the weight for which the tie-down system is certified. Consult the tie-down manufacturer's documentation.
- If you are unsure how much your mobility device weighs, then you must have it weighed using calibrated scales.

7.2 Dismantling the scooter for transport

Please proceed as follows to dismantle the scooter for transport:

1. Remove the seat. Refer to *4.5 Disengaging the seat to rotate it or remove it, page 23.*
2. Remove the battery box. Refer to *7.2.1 Removing/Installing the battery box, page 37.*
3. Remove the drive unit. Refer to *7.2.2 Removing the drive unit, page 39.*
4. Fold the tiller down to the lowest locked position. Refer to *4.7 Adjusting the tiller angle, page 24.*

7.2.1 Removing/Installing the battery box



CAUTION!

Risk of strains from lifting heavy parts!

- Use proper lifting techniques.



CAUTION!

Risk of injury from unsecured scooter parts

Removing the battery box will release the LITE-LOCK™ mechanism allowing the front frame assembly to separate from the rear frame assembly.

- Do not lift or move the scooter without the battery box unless you want to disassemble it. Refer to *7.2 Dismantling the scooter for transport, page 37.*

Removing the Battery Box

1. Remove the seat. Refer to *4.5 Disengaging the seat to rotate it or remove it, page 23.*
- 2.

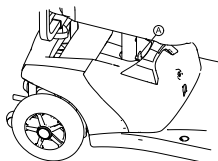

Fig. 7-1



Fig. 7-2

Grab the handle of the battery box, pull the battery box latch Ⓐ with your thumb and remove the battery box.

Installing the Battery Box

1. Remove the seat. Refer to *4.5 Disengaging the seat to rotate it or remove it, page 23.*
2. Holding the battery box handle, carefully lower the battery box on to the battery tray in the scooter.
3. Press down the battery box to engage the connector on the battery box with the connector on the scooter base.

4.

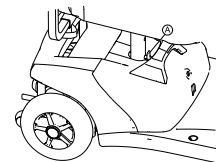

Fig. 7-3

Ensure the battery box latch Ⓐ engages the mounting hole in the seat post.

5. Reinstall the seat. Refer to *4.5 Disengaging the seat to rotate it or remove it, page 23.*

7.2.2 Removing the drive unit



CAUTION!

Risk of strains from lifting heavy parts!

– Use proper lifting techniques.

1.

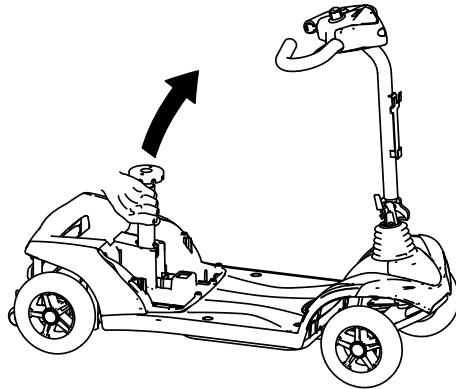

Pull up the seat post to lift up the chassis.

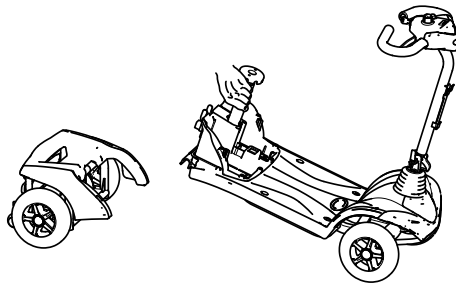

The drive unit separates from the chassis.

1576371-D

7.3 Reassembling the scooter



CAUTION!

Risk of strains from lifting heavy parts!

– Use proper lifting techniques.

1. Unfold the tiller. Refer to 4.7 *Adjusting the tiller angle*, page 24.

2.

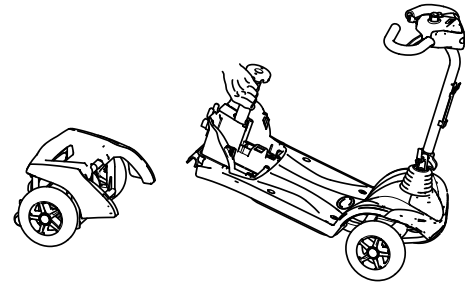

Pull up the seat post to lift up the chassis and hook the chassis onto the drive unit.

3. Refit the battery box. Refer to 7.2.1 *Removing/Installing the battery box*, page 37.

4.

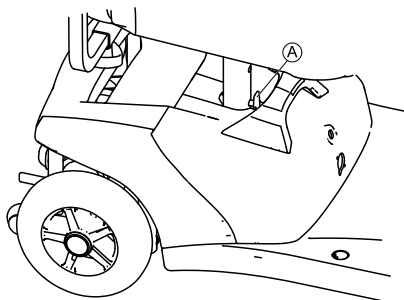

Make sure the latch Ⓐ of the battery box is locked.

5. Refit the seat. Refer to 4.5 *Disengaging the seat to rotate it or remove it*, page 23.

7.4 Transferring Mobility Device to Vehicle



WARNING!
Risk of injury and damage to mobility device and vehicle

Risk of tipping over or uncontrolled movements of mobility device if transferred to vehicle using a ramp.

- Transfer mobility device to vehicle without user.
- Alternatively, a platform lift may be used.
- Ensure that total weight of mobility device does not exceed maximum permitted total weight for ramp or platform lift.



WARNING!

Risk of injury and damage to mobility device

If mobility device must be transferred to vehicle via lift, when power is turned on, there is a risk that device may act erratically and fall off lift.

- Before transferring mobility device via lift, turn off product.

1. Drive or push your mobility device into transport vehicle using suitable ramp.

7.5 Transporting Mobility Device Without Occupant



CAUTION!

Risk of injury

- If you are unable to fasten your mobility device securely in a transport vehicle, Invacare recommends that you do not transport it.

Your mobility device may be transported without restrictions, whether by road, rail or by air. Individual transport companies have, however, guidelines which can possibly restrict or forbid certain transport procedures. Please ask the transport company regarding each individual case.

- Before transporting your mobility device, make sure the motors are engaged and that the remote is switched off. Invacare strongly recommends that you additionally disconnect or remove the batteries. Refer to Removing the batteries.
- Invacare strongly recommends securing the mobility device to the floor of the transporting vehicle.

8 Maintenance

8.1 Maintenance Introduction

The term “Maintenance” means any task performed to ensure that a medical device is in good working order and ready for use as intended. Maintenance encompasses

8.2 Inspection checks

The following table lists inspection checks that should be performed by the user and their intervals. If the mobility device fails to pass one of the inspection checks, please refer to the chapter indicated or contact your authorised Invacare dealer. A more comprehensive list of inspection checks and instructions for maintenance work can be found in the service manual for this device, which can be obtained from Invacare. That manual, however, is intended to be used by trained and authorised service technicians, and describes tasks which are not intended to be performed by the user.

Inspection work (to be carried out by user)	Before each journey	Weekly	Monthly
Horn:			
Check function Please contact your dealer in case of failure.	✓		
Tires:			
Check for foreign bodies (glass splinters, nails) and damage. Replace tire if necessary.		✓	
Batteries / electrical system			
Check battery charging status. Charge batteries if necessary (refer to 6.2.3 <i>How to charge the batteries, page 33</i>).	✓		
Checked all connecting plugs for condition and stable connections. Press connecting plugs firmly together if necessary.			✓

different areas, such as everyday care and cleaning, inspection checks, repair tasks and refurbishment.



Have your vehicle checked once a year by an authorised Invacare provider to maintain its driving safety and roadworthiness.

Inspection work (to be carried out by user)	Before each journey	Weekly	Monthly
Wheel lock (if fitted):			
Check wheel lock function. Please contact your dealer if the brake is defective.	✓		

8.3 Wheels and Tyres

Dealing With Wheel Damages

In case of having a damaged wheel, contact your provider. Because of safety reasons do not have the wheel repaired by yourself or by not authorised persons.

Dealing With Pneumatic Tyres



Risk of damage to tyre and rim

Never drive with too low tyre pressure, this could result in damage to tyre.

If tyre pressure is exceeded rim could be damaged.

– Inflate tyres to recommended pressure.



Use tyre gauge to check pressure.

Check weekly that the tyres are inflated to the correct pressure, see chapter *Inspection Checks*.

For recommended tyre pressure see inscription on tyre/rim or contact Invacare. Compare table below for conversion.

psi	bar
22	1.5
23	1.6
25	1.7
26	1.8
28	1.9
29	2.0
30	2.1
32	2.2
33	2.3
35	2.4
36	2.5
38	2.6
39	2.7
41	2.8
44	3.0

8.4 Short-Term Storage

In case a serious fault is detected, a number of safety mechanisms are built into your mobility device and will protect it. The power module prevents your mobility device from driving.

When the mobility device is in such a condition and while waiting for repair:

1. Switch off power.
2. Disconnect the batteries.
Depending on the mobility device model, you can either remove the battery packs or disconnect the batteries from the power module. Refer to the corresponding chapter about disconnecting the batteries.
3. Contact your provider.

8.5 Long-Term Storage

In case your mobility device is not used for a longer period of time, you need to prepare it for storage to ensure a longer life for your mobility device and batteries.

Storing Mobility Device and Batteries

- We recommend to store the mobility device at a temperature of 15 °C, avoid hot and cold extremes when storing to ensure a long service life of the product and batteries.
- The components are tested and approved for greater temperature ranges as detailed below:
 - Allowable temperature range to store the mobility device is -40° up to 65 °C.
 - Allowable temperature range to store batteries is -25° up to 65 °C.

- Even not being used, batteries discharge themselves. Best practice is to disconnect the battery supply from the power module if storing the mobility device longer than two weeks. Depending on the mobility device model, you can either remove the battery packs or disconnect the batteries from the power module. Refer to the corresponding chapter about disconnecting the batteries. If in doubt which cable to disconnect, contact your provider.
- Batteries should always be fully charged before storing.
- If storing the mobility device longer than four weeks, check the batteries once a month and recharge as needed (before gauge reads half full) to avoid damage.
- Store in a dry, well-ventilated environment protected from outer influences.
- Slightly overinflate pneumatic tyres.
- Position the mobility device on flooring that is not discoloured by contact with tyre rubber.

Preparing Mobility Device for Use

- Re-connect the battery supply to the power module.
- The batteries must be charged before use.
- Have the mobility device checked by an authorised Invacare provider.

8.6 Cleaning and Disinfection

8.6.1 General safety information



CAUTION!

Risk of contamination

- Take precautions for yourself and use appropriate protective equipment.

**CAUTION!****Risk of electric shock and product damage**

- Switch off the device and disconnect from mains, if applicable.
- When cleaning electronic components consider their protection class regarding water ingress.
- Make sure that no water splashes to the plug or the wall outlet.
- Do not touch the power socket with wet hands.

**IMPORTANT!**

Wrong fluids or methods can harm or damage the product.

- All cleaning agents and disinfectants used must be effective, compatible with one another and must protect the materials they are used to clean.
- Never use corrosive fluids (alkalines, acid etc.) or abrasive cleaning agents. We recommend an ordinary household cleaning agent such as dishwashing liquid, if not specified otherwise in the cleaning instructions.
- Never use a solvent (cellulose thinner, acetone etc.) that changes the structure of the plastic or dissolves the attached labels.
- Always make sure that the product is completely dried before taking into use again.



For cleaning and disinfection in clinical or long-term care environments, follow your in-house procedures.

8.6.2 Cleaning Intervals**IMPORTANT!**

Regular cleaning and disinfection enhances smooth operation, increases the service life and prevents contamination.

Clean and disinfect the product

- regularly while it is in use,
- before and after any service procedure,
- when it has been in contact with any body fluids,
- before using it for a new user.

8.6.3 Cleaning**IMPORTANT!**

- The product does not tolerate cleaning in automatic washing plants, with high-pressure cleaning equipment or steam.

**IMPORTANT!**

- Dirt, sand and seawater can damage the bearings and steel parts can rust if the surface is damaged.
- Only expose the product to sand and seawater for short periods and clean it after every trip to the beach.
- If the product is dirty, wipe off the dirt as soon as possible with a damp cloth and dry it carefully.

1. Remove any installed optional equipment (only optional equipment which does not require tools).
2. Wipe down the individual parts using a cloth or soft brush, ordinary household cleaning agents (pH = 6 - 8) and warm water.
3. Rinse the parts with warm water.
4. Thoroughly dry the parts with a dry cloth.



Car polish and soft wax can be used on painted metal surfaces to remove abrasions and restore gloss.

Cleaning upholstery

For cleaning upholstery refer to the instructions on the labels of the seat, cushion and backrest cover.

8.6.4 Disinfection



Information on recommended disinfectants and methods can be found on <https://vah-online.de/en/for-users>.

1. Wipe down all generally accessible surfaces with a soft cloth and ordinary household disinfectant.
2. Allow the product to air-dry.

9 After Use

9.1 Reconditioning

This product is suitable for reuse. To recondition the product for a new user, carry out the following actions:

- Inspection
- Cleaning and disinfection
- Adaptation to the new user

For detailed information, see *8 Maintenance, page 41* and the service manual for this product.

Make sure that the user manual is handed over with the product.

If any damage or malfunction is detected, do not reuse the product.

9.2 Disposal



WARNING!

Environmental Hazard

Device contains batteries.

This product may contain substances that could be harmful to the environment if disposed of in places (landfills) that are not appropriate according to legislation.

- DO NOT dispose of batteries in normal household waste.
- Batteries MUST be taken to a proper disposal site. The return is required by law and free of charge.
- Do only dispose discharged batteries.
- Cover terminals of lithium batteries prior to disposal.
- For information on the battery type see battery label or chapter *11 Technical Data, page 51*.

Be environmentally responsible and recycle this product through your recycling facility at its end of life.

Disassemble the product and its components, so the different materials can be separated and recycled individually.

The disposal and recycling of used products and packaging must comply with the laws and regulations for waste handling in each country. Contact your local waste management company for information.

10 Troubleshooting

10.1 Diagnosis and fault repair

The electronic system offers diagnostic information to support the technician during the recognition and rectification of faults on the scooter. If there is a fault, the status display flashes several times, pauses, then flashes again. The type of fault is displayed by the number of flashes in each group, which are also known as the "flash code".

The electronic system reacts differently depending on the seriousness of the fault and its effect on user safety. It can, for example:

- Show the flash code as a warning and allow both driving and normal operation to continue.
- Display the flash code, stop the scooter and prevent further travel until the electronic system has been switched off and switched on again.
- Display the flash code, stop the scooter and not permit further travel until the fault has been rectified.

You can find detailed descriptions of individual flash codes, including possible causes and fault repair, in the section entitled *10.1.2 Error codes and diagnostic codes, page 48*.

10.1.1 Error diagnosis

If the scooter shows a failure, please use the following guide to locate the fault.



Before making any diagnosis, ensure that the scooter has been switched on at the keyswitch.

If the status display is OFF:

- Check whether the keyswitch is SWITCHED ON.
- Check whether all cables are correctly connected.

If the status bar indicator is FLASHING:

- Count the number of flashes and then proceed to the next section.

10.1.2 Error codes and diagnostic codes

Flash code	Fault	Consequence for the scooter	Comments
1	Batteries must be charged	Continues to drive	<ul style="list-style-type: none"> The batteries are discharged. Charge the batteries as soon as possible.
2	Battery voltage too low	Stops driving	<ul style="list-style-type: none"> The batteries are depleted. Charge batteries. If you switch the scooter off for a few minutes, the batteries can often recuperate to such a stage that a short journey is still possible. You should only do this in an emergency, however, because this causes the batteries to become excessively discharged.
3	Battery voltage too high	Stops driving	<ul style="list-style-type: none"> The battery voltage is too high. If the battery charger is connected, disconnect it from the scooter. The electronic system charges the batteries when running downhill and when braking. This fault is caused when the battery voltage becomes too high during this process. Switch the scooter off and on again.
4	Power time exceeded	Stops driving	<ul style="list-style-type: none"> The maximum current was exceeded over too long a period, probably because the motor was overloaded or has been working against an immovable resistance. Switch the scooter off, wait a few minutes and then switch on again. The electronic system has determined a motor short-circuit. Check the wiring harness for short-circuit and check the motor. Contact your Invacare provider.

Flash code	Fault	Consequence for the scooter	Comments
5	Brake failure	Stops driving	<ul style="list-style-type: none"> • Ensure that the disengaging lever is in the engaged position. • There is a defect in the braking coil or in the cabling. Check the magnetic brake and cabling for open or short-circuited circuitry. Contact your Invacare provider.
6	No neutral position when switching scooter on.	Stops driving	<ul style="list-style-type: none"> • Drive lever is not in neutral when the keyswitch was turned. Put the drive lever in neutral, turn the power off and then turn on again. • It may be necessary to replace the drive lever. Contact your Invacare provider.
7	Fault in speed potentiometer	Stops driving	<ul style="list-style-type: none"> • The drive lever controls could be faulty or incorrectly connected. Check the cabling for open or short-circuited circuitry. • Potentiometer is not correctly adjusted and must be replaced. Contact your Invacare provider.
8	Motor voltage error	Stops driving	<ul style="list-style-type: none"> • The motor or its cabling is defective. Check the cabling for open or short-circuited circuitry.
9	Miscellaneous internal fault	Stops driving	<ul style="list-style-type: none"> • Contact your Invacare provider.
10	Push/freewheel mode error	Stops moving	<ul style="list-style-type: none"> • The scooter has exceeded the permissible maximum speed during pushing or freewheeling. Switch the electronics system off and on again.

10.2 Resetting the circuit breaker



WARNING!

- NEVER defeat or bypass the circuit breaker.
- ONLY replace with a circuit breaker of the same rating.



- Key must be removed from ignition before resetting circuit breaker.
- Resetting the circuit breaker may be needed if the scooter does not turn on and the reset button has popped out about 6 mm.

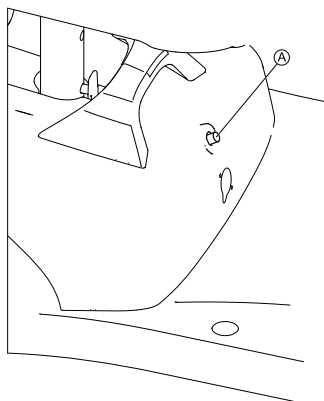

1. To reset, press the circuit breaker button **A** located on the front of the battery box.

11 Technical Data

11.1 Technical specifications

The technical information provided hereafter applies to a standard configuration or represents maximum achievable values. These can change if accessories are added. The precise changes to these values are detailed in the sections for the respective accessories.

 Note that in some cases the measured values may vary up to ± 10 mm.

Permissible operating and storage conditions	
Temperature range for operation according to ISO 7176-9:	<ul style="list-style-type: none"> -25 °C ... +50 °C
Recommended storage temperature:	<ul style="list-style-type: none"> 15 °C
Temperature range for storage according to ISO 7176-9:	<ul style="list-style-type: none"> -25 °C ... +65 °C with batteries -40 °C ... +65 °C without batteries

Electrical system	
Motor	<ul style="list-style-type: none"> 1 x 200 W
Batteries	<ul style="list-style-type: none"> 2 x 12 V/12 Ah (C20) leakproof/AGM 2 x 12 V/18 Ah (C20) leakproof/AGM
Main fuse	<ul style="list-style-type: none"> 40 A
Degree of protection	IPX4 ¹

Charging device	For 12 Ah batteries	For 18 Ah batteries
Output current	<ul style="list-style-type: none"> 2 A \pm 	<ul style="list-style-type: none"> 5 A \pm 5 %
Output voltage	<ul style="list-style-type: none"> 24 V nominal (12 cells) 	<ul style="list-style-type: none"> 28.8 V nominal (12 cells)

Tyres	
Tyre type	<ul style="list-style-type: none"> • 200 x 50 puncture-proof • 210 x 65 puncture-proof

Driving characteristics	
Speed (dependent on country - please ask your dealer which speed is available in your country.)	<ul style="list-style-type: none"> • 6 km/h • 8 km/h
Min. braking distance	<ul style="list-style-type: none"> • 1000 mm (6 km/h) • 1500 mm (8 km/h)
Rated slope ²	<ul style="list-style-type: none"> • 6° (10.5 %)
Max. climbable obstacle height	<ul style="list-style-type: none"> • 45 mm (tyre type 200 x 50) • 50 mm (tyre type 210 x 65)
Turning diameter	<ul style="list-style-type: none"> • 1940 mm (3-wheel) • 2200 mm (4-wheel)
Reversing width	<ul style="list-style-type: none"> • 1300 mm (tyre type 200 x 50) • 1400 mm (tyre type 210 x 65)
Drive range in accordance with ISO 7176-4 ³	<ul style="list-style-type: none"> • 16 km (18 Ah batteries) • 11 km (12 Ah batteries)

Dimensions according to ISO 7176-15	
Total length	<ul style="list-style-type: none"> • 1010 mm
Max. total width	<ul style="list-style-type: none"> • 610 mm
Total height	<ul style="list-style-type: none"> • 840 mm
Stowage length	<ul style="list-style-type: none"> • 1010 mm

Dimensions according to ISO 7176–15	
Stowage width	• 610 mm
Stowage height	• 710 mm
Seat height ⁴	• 490 mm
Seat width	• 465 mm
Seat depth	• 400 mm
Armrest height	• 225 mm
Armrest depth ⁵	• 270 mm
Horizontal location of axle ⁶	• 40 mm

Weight	3-wheel	4-wheel
Kerb weight	<ul style="list-style-type: none"> • 41.7 kg (12 Ah batteries) • 46.4 kg (18 Ah batteries) 	<ul style="list-style-type: none"> • 44.2 kg (12 Ah batteries) • 48.9 kg (18 Ah batteries)

Components weight	
Front section	<ul style="list-style-type: none"> • 13.1 kg (3-wheel) • 15.6 kg (4-wheel)
Drive unit	<ul style="list-style-type: none"> • 9.6 kg
Seat	<ul style="list-style-type: none"> • 9.6 kg
Battery box 12 Ah	<ul style="list-style-type: none"> • 9.4 kg
Battery box 18 Ah	<ul style="list-style-type: none"> • 14.1 kg

Payload	
Max. payload	• 136 kg

Axle loads	
Max. front axle load	• 60 kg
Max. rear axle load	• 130 kg

- 1 IPX4 classification means that the electrical system is protected against spray water.
- 2 Static stability according to ISO 7176-1 = 9° (15.8 %)
Dynamic stability according to ISO 7176-2 = 6° (10.5 %)
- 3 Note: The drive range of a mobility device is strongly influenced by external factors, such as the speed setting of the mobility device, the charging state of the batteries, surrounding temperature, local topography, road surface characteristics, tyre pressure, weight of user, drive style and use of batteries for lighting, servos etc.
The specified values are theoretical maximum achievable values measured according to ISO 7176-4.
- 4 Measured without seat cushion
- 5 Distance between backrest reference plane and most forward part of armrest assembly
- 6 Horizontal distance of wheel axle from intersection of loaded seat and backrest reference planes

12 Service

12.1 Inspections Performed

It is confirmed by stamp and signature that all jobs listed in the inspection schedule of the service and repair instructions have been properly performed. The list of the inspection jobs to be performed can be found in the service manual which is available through Invacare.

Delivery Inspection	1st Annual Inspection
Stamp of authorised provider / Date / Signature	Stamp of authorised provider / Date / Signature
2nd Annual Inspection	3rd Annual Inspection

Stamp of authorised provider / Date / Signature	Stamp of authorised provider / Date / Signature
4th Annual Inspection	5th Annual Inspection
Stamp of authorised provider / Date / Signature	Stamp of authorised provider / Date / Signature

Invacare representatives/distributors

Australia:

Invacare Australia Pty. Ltd.
1 Lenton Place, North Rocks NSW
2151
Australia
Phone: 1800 460 460
Fax: 1800 814 367
orders@invacare.com.au
www.invacare.com.au

United Kingdom:

Invacare Limited
Pencoed Technology Park, Pencoed
Bridgend CF35 5AQ
Tel: (44) (0) 1656 776 222
Fax: (44) (0) 1656 776 220
uk@invacare.com
www.invacare.co.uk

Canada:

Invacare Canada L.P.
570 Matheson Blvd East, Unit 8
CDN Mississauga, On. L4Z 4G4
Phone: (905) 890 8300
Toll Free: 800.668.5324
www.invacare.ca

Ireland:

Invacare Ireland Ltd,
Unit 5 Seatown Business Campus
Seatown Road, Swords, County Dublin
Tel : (353) 1 810 7084
Fax: (353) 1 810 7085
ireland@invacare.com
www.invacare.ie

New Zealand:

Invacare New Zealand Ltd
4 Westfield Place, Mt Wellington 1060
New Zealand
Phone: 0800 468 222
Fax: 0800 807 788
sales@invacare.co.nz
www.invacare.co.nz

Eastern Europe, Middle East & CIS:

Invacare EU Export
Am Achener Hof 8
D-88316 Isny
Tel: (49) (0)7562 700 397
eu-export@invacare.com
www.invacare-eu-export.com



European representative:

EMERGO EUROPE
Prinsessegracht 20
2514 AP, The Hague
The Netherlands



Importer:

Invacare GmbH
Am Achener Hof 8
D-88316 Isny
Germany



Manufacturer:

CHIEN TI ENTERPRISE CO. LTD.
No. 13, Lane 227, Fu Ying Road
Hsin Chuang, Taipei, Taiwan
R.O.C.

1576371-D 2021-01-01



Making Life's Experiences Possible®



Yes, you can.®