

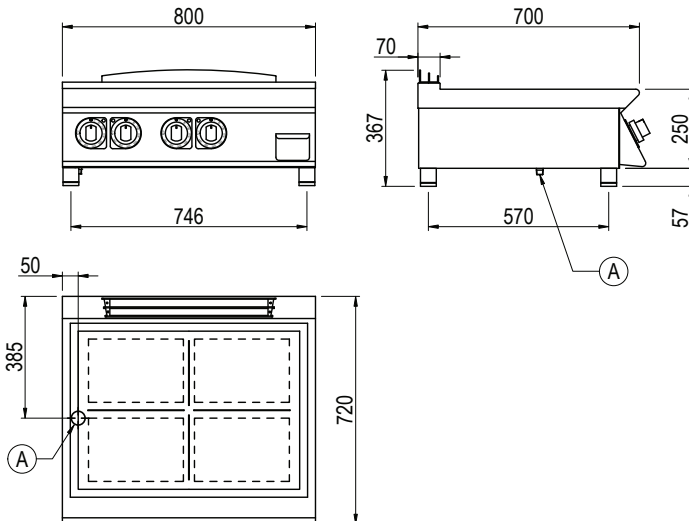

Product Information:

- Class leading, European style, professional quality and reliability since 1963
- 700 series, ultra-thick, reinforced radiant plate with 4 independent cooking zones (2.6kW)
- Heating elements with Hi-limit temperature protection
- Temperature regulation via thermostat (50°C – 400°C)
- Robust 304 grade stainless steel construction with rounded corners for improved cleaning
- Removable grease tray
- Height adjustable stainless steel feet for a 900mm working height
- 24-month warranty

General Drawing:



Specifications:

Model	TE740TT
W x D x H (mm)	800 x 720 x 367
Weight	110kg
Plate Dimensions (mm)	700 x 500
Packed Dimensions (mm)	850 x 825 x 570
Packed Weight (mm)	120kg
Electrical Connection	3Ø + N + E 415VAC / 50Hz / 10.4kW

Legend:

A Electrical Connection