

PAPR HELMET

2 YEAR
PRODUCT
WARRANTY

Powered Air Purifying Respirator | U21014K



UNIMIG®

CONTENTS

SAFETY.....	3
INTRODUCTION.....	6
APPROVALS.....	6
USAGE.....	6
UNPACKING/ASSEMBLY.....	7
BEFORE USE/ FITTING.....	10
LCD AND OPERATION.....	13
PAPR WELDING HELMET PARTS LIST.....	14
REPLACEMENT.....	16
MAINTENANCE & STORAGE.....	16
TROUBLESHOOTING.....	17
SPECIFICATION.....	18
MARKING EXPLANATION.....	18
WARRANTY.....	19

Welding and cutting equipment can be dangerous to both the operator and people in or near the surrounding working area, if the equipment is not correctly operated. Equipment must only be used under the strict and comprehensive observance of all relevant safety regulations.

Read and understand this instruction manual carefully before the installation and operation of this equipment.

Machine Operating Safety

- Do not switch the function modes while the machine is operating. Switching of the function modes during welding can damage the machine. Damage caused in this manner will not be covered under warranty.
- Disconnect the electrode-holder cable from the machine before switching on the machine, to avoid arcing should the electrode be in contact with the work piece.
- Operators should be trained and or qualified.



Electric shock: It can kill. Touching live electrical parts can cause fatal shocks or severe burns. The electrode and work circuit is electrically live whenever the output is on. The input power circuit and internal machine circuits are also live when power is on. In MIG/MAG welding, the wire, drive rollers, wire feed housing, and all metal parts touching the welding wire are electrically live. Incorrectly installed or improperly grounded equipment is dangerous.

- Connect the primary input cable according to Australian and New Zealand standards and regulations.
- Avoid all contact with live electrical parts of the welding/cutting circuit, electrodes and wires with bare hands.
- The operator must wear dry welding gloves while he/she performs the welding/cutting task.
- The operator should keep the work piece insulated from himself/herself.
- Keep cords dry, free of oil and grease, and protected from hot metal and sparks.
- Frequently inspect input power cable for wear and tear, replace the cable immediately if damaged, bare wiring is dangerous and can kill.
- Do not use damaged, under sized, or badly joined cables.
- Do not drape cables over your body.
- We recommend (RCD) safety switch is used with this equipment to detect any leakage of current to earth.



Fumes and gases are dangerous. Smoke and gas generated whilst welding or cutting can be harmful to people's health. Welding produces fumes and gases. Breathing these fumes and gases can be hazardous to your health.

Do not breathe the smoke and gas generated whilst welding or cutting, keep your head out of the fumes

- Keep the working area well ventilated, use fume extraction or ventilation to remove welding/cutting fumes and gases.
- In confined or heavy fume environments always wear an approved air-supplied respirator.
- Welding/cutting fumes and gases can displace air and lower the oxygen level causing injury or death. Be sure the breathing air is safe.
- Do not weld/cut in locations near de-greasing, cleaning, or spraying operations. The heat and rays of the arc can react with vapours to form highly toxic and irritating gases.
- Materials such as galvanized, lead, or cadmium plated steel, containing elements that can give off toxic fumes when welded/cut. Do not weld/cut these materials unless the area is very well ventilated, and or wearing an air supplied respirator.



Arc rays: harmful to people's eyes and skin. Arc rays from the welding/cutting process produce intense visible and invisible ultraviolet and infrared rays that can burn eyes and skin.

Always wear a welding helmet with correct shade of filter lens and suitable protective clothing including welding gloves whilst the welding/cutting operation is performed.

- Measures should be taken to protect people in or near the surrounding working area. Use protective screens or barriers to protect others from flash, glare and sparks; warn others not to watch the arc.

SAFETY



Fire hazard. Welding/cutting on closed containers, such as tanks, drums, or pipes, can cause them to explode. Flying sparks from the welding/cutting arc, hot work piece, and hot equipment can cause fires and burns. Accidental contact of electrode to metal objects can cause sparks, explosion, overheating, or fire. Check and be sure the area is safe before doing any welding/cutting.

- The welding/cutting sparks & spatter may cause fire, therefore remove any flammable materials well away from the working area. Cover flammable materials and containers with approved covers if unable to be moved from the welding/cutting area.
- Do not weld/cut on closed containers such as tanks, drums, or pipes, unless they are properly prepared according to the required Safety Standards to insure that flammable or toxic vapours and substances are totally removed, these can cause an explosion even though the vessel has been "cleaned". Vent hollow castings or containers before heating, cutting or welding. They may explode.
- Do not weld/cut where the atmosphere may contain flammable dust, gas, or liquid vapours (such as petrol)
- Have a fire extinguisher nearby and know how to use it. Be alert that welding/cutting sparks and hot materials from welding/cutting can easily go through small cracks and openings to adjacent areas. Be aware that welding/cutting on a ceiling, floor, bulkhead, or partition can cause fire on the hidden side.



Gas Cylinders. Shielding gas cylinders contain gas under high pressure. If damaged, a cylinder can explode. Because gas cylinders are normally part of the welding/cutting process, be sure to treat them carefully. CYLINDERS can explode if damaged.

- Protect gas cylinders from excessive heat, mechanical shocks, physical damage, slag, open flames, sparks, and arcs.
- Insure cylinders are held secure and upright to prevent tipping or falling over.
- Never allow the welding/cutting electrode or earth clamp to touch the gas cylinder, do not drape welding cables over the cylinder.
- Never weld/cut on a pressurised gas cylinder, it will explode and kill you.
- Open the cylinder valve slowly and turn your face away from the cylinder outlet valve and gas regulator.



Gas build up. The build up of gas can causes a toxic environment, deplete the oxygen content in the air resulting in death or injury. Many gases use in welding/cutting are invisible and odourless.

- Shut off shielding gas supply when not in use.
- Always ventilate confined spaces or use approved air-supplied respirator.



Electronic magnetic fields. MAGNETIC FIELDS can affect Implanted Medical Devices.

- Wearers of Pacemakers and other Implanted Medical Devices should keep away.
- Implanted Medical Device wearers should consult their doctor and the device manufacturer before going near any electric welding, cutting or heating operation.



Noise can damage hearing. Noise from some processes or equipment can damage hearing.

- Wear approved ear protection if noise level is high.



Hot parts. Items being welded/cut generate and hold high heat and can cause severe burns.

Do not touch hot parts with bare hands. Allow a cooling period before working on the welding/cutting gun. Use insulated welding gloves and clothing to handle hot parts and prevent burns.

Please read and understand all instructions before using.

- Be sure that the dark shade of the lens in the welding helmet is on the correct shade number for your application.
- The helmet and lenses are not suitable for “overhead” welding application, laser welding, or laser cutting applications.
- Welding helmets are designed to protect the eyes and face from sparks, spatter, and harmful radiation under normal welding conditions.
- This helmet will not protect against explosive devices or corrosive liquids. Machine guards or eye splash protection must be used when these hazards are present.
- Impact resistant, primary eye protection, spectacles or goggles that meet current ANSI specifications, must be worn at all times when using this welding helmet.
- Avoid work positions that could expose unprotected areas of the body to sparks, spatter, direct and/or reflected radiation. Use appropriate protection if exposure cannot be avoided.
- Before each use, check that the protection plates are clean and that no dirt is covering the sensors on the front of the lens.
- Inspect all operating parts before each use for signs of wear or damage. Any scratched, cracked, or pitted parts should be replaced immediately.
- Do not make any modifications to either the welding lens or helmet, other than those specified in this manual. Do not use any replacement parts other than those specified in this manual. Unauthorised modifications and replacement parts will void the warranty and expose the user to the risk of personal injury.
- If this lens does not darken when striking arc, stop welding immediately and check the helmet is in Weld Mode and not Grind Mode. If the issue persists, contact your local UNIMIG Service Department.
- Do not immerse this lens in water.
- Do not use any solvents on any lens or helmet components.
- The recommended operating temperature range for this welding lens is -10°C to 65°C (14°F-149°F). Do not use this device beyond these temperature limits.
- Failure to follow these warnings and/or failure to follow all of the operating instructions could result in severe personal injury.

PAPR WELDING HELMET

INTRODUCTION

U21014K Respiratory System is a combined face and breathing protection device for increased safety and comfort during welding. Please read these instructions carefully before unpacking. For proper use, see User Instructions or contact the manufacturers for help.

Address and telephone number information is printed at the back of this leaflet.

Your U21014K Air Powered Respirator system should include:

- Auto-darkening welding helmet
- U21014K PAPR blower unit with attached battery and filter
- Belt
- Battery charger
- Airflow indicator
- Instruction manual
- Backpack

If any of the above components are not included in your kit, please contact the supplier immediately.

APPROVALS

The U21014K system complies with the requirements of Australian/New Zealand standard AS/NZS 1716:2012 as a PAPR-P2 device. All components used in U21014K Respiratory System must be "UNIMIG approved" manufacturer's parts, and must be used in accordance with the instructions in this manual.

NOTE: The approval is not valid if the product is incorrectly used together with non-approved parts or components.

NOTE: Only the U21014K particle filter, gas filter and pre-filter can be used together with this system. Filters from other manufacturers should under no circumstances be used.

USAGE

The U21014K Respiratory System is designed to provide a supply of filtered air via a breathing tube to a welding headpiece. The complete system is a breathing protection device complying with Australian/New Zealand standard AS/NZS 1716:2012, class P2. The equipment can be used in environment that requires a class P2 breathing protection device. It protects against particulate contamination.

LIMITATIONS TO USE

The U21014K Respiratory System must only be used with the U21014K unit switched on. If the equipment is used without the U21014K unit switched on, there is a risk of high concentration of CO₂ and the oxygen level in the helmet will fall, thus little or no protection is given in the power-off state and this is considered to be an abnormal situation. Do not remove the helmet or turn off the air filter unit until you have vacated the contaminated area. If you are not sure about the concentration of pollution, or about equipment performance, ask the industrial safety engineer. The manufacturer is not responsible for injury following incorrect use or incorrect choice of equipment.

- DO NOT use U21014K with the blower unit switched off.
- DO NOT use U21014K in an atmosphere that is immediately hazardous to user hygiene or health and or has oxygen content of less than 19.5% or contains unknown substances.
- DO NOT use U21014K in an explosive atmosphere.
- DO NOT use U21014K in confined spaces or areas of poor ventilation.
- DO NOT use U21014K in high winds.
- DO NOT alter or modify in any way.
- DO NOT touch any of the moving parts.
- DO NOT allow water or other liquids to enter the impeller chamber, the filter or battery compartment.
- DO NOT use the U21014K as head protection. THIS HEAD COVERING DOES NOT MEET THE REQUIREMENTS OF AS/NZS 1801. IF HEAD PROTECTION IS REQUIRED CONSULT YOUR SAFETY OFFICER
- The helmet and lenses are not suitable for "overhead" welding application, laser welding, or laser cutting applications.

UNPACKING/ASSEMBLY

Check that correct number of components has been supplied, as in FIGURE 1.

Check that the apparatus is complete, undamaged and correctly assembled. Any damaged or defective parts must be replaced before use.



1. Open U21014K unit and check the spark arrestor, pre-filter and filter, FIGURE 2 (A).
2. Replace the filter back into the casing if it's in good condition. FIGURE 2(B).
 - i. Place the spark arrestor into the filter cover.
 - ii. Place the pre-filter into the above combination.
 - iii. Place the filter into the above combination.
 - iv. Click the above combination into the Turbo unit.

NOTE: Make sure that the filter is properly placed into the casing while installing.

WARNING: The filter can only be fitted to the turbo unit.

DO NOT directly fit the filter to the helmet/hood.

FIGURE 2(A)

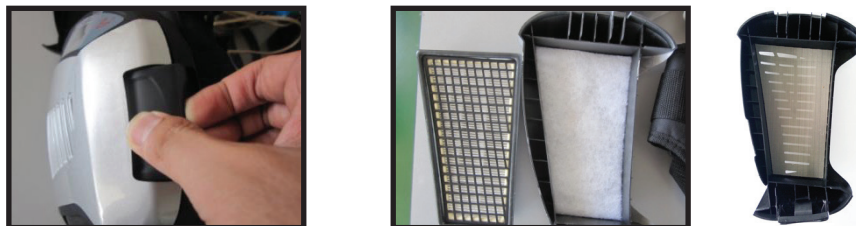

FIGURE 2(B)



PAPR WELDING HELMET

3. Install the U21014K blower on the belt.
 - i. Remove the release buckle out of the belt. FIGURE 3(A).
 - ii. Draw the fasten belt out from the waist connector. FIGURE 3(B)
 - iii. Slide the fasten belt into the blower unit through the two blower slots. FIGURE 3(C).
 - iv. Slide the fasten belt back into the waist connector. FIGURE 3(D).
 - v. Put the release buckle back into the belt. FIGURE 3(E).
 - vi. Adjust the belt tightness so it can fit well with your shoulder and waist. FIGURE 3(F).
 - vii. NOTE: Check that the belt is securely fastened



FIGURE 3 (A)



FIGURE 3 (B)

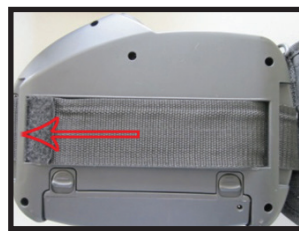
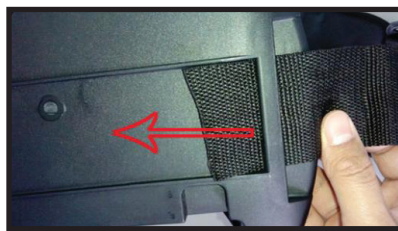

FIGURE 3 (C)



FIGURE 3 (D)



FIGURE 3 (E)



FIGURE 3 (F)

4. Connect the breathing hose between the welding helmet and the U21014K blower, FIGURE 4. Check that the breathing tube is securely fastened.
 - i. NOTE: If the breathing tube is broken, please replace it.



FIGURE 4

Carefully observe the instructions that explain how the equipment is to be used, before taking it into service.

All components must be installed/ used in accordance with this manual if the equipment is to offer the specified protection. If any component is missing, or if anything is not clear, contact the supplier.

Markings on the battery (see FIGURE 5).



FIGURE 5

PAPR WELDING HELMET

BEFORE USE/ FITTING

BATTERY CHARGING, FIGURE 6.

The system has a 100-240Volt, 1.5A battery charger. The battery can be charged when installed in the U21014K unit or separately.



FIGURE 6

WARNING: The battery can only be charged with supplied battery charger (Part No.P-06 03 001).

All new units must be charged before they are used for the first time.

The charger must not be used in any circumstances for any other purpose than for which it was manufactured. It is intended for indoor use (must be protected from damp) and must not be used to charge non-rechargeable batteries.

The battery will be fully charged in about 3.5hours (also the heavy duty battery) this depends on residual capacity.

The red light goes on during battery charged and the light will turn green when it is full charged (FIGURE 7).



FIGURE 7

The battery will discharge during a long period in storage. For this reason, always re-charge the battery if it has been stored for more than 15 days. To achieve maximum power when the battery is new, or has been stored for more than 3 months, charge and discharge the battery at least twice, remove the battery out of the U21014K unit and store separately.

Points of attention:

1. Check that the mains supply voltage to the charger is correct.
2. Connect the battery charger to the wall socket.
3. Connect the battery charger to the battery.

WARNING:

If the U21014K unit starts, switch it off while charging.

The battery icon on the U21014K unit is used for battery capacity instead of the charging state indicating (FIGURE 8). Always refer to charging light to tell the charging state.

Recommended surrounding temperature at charging is between 0 to 40°C.

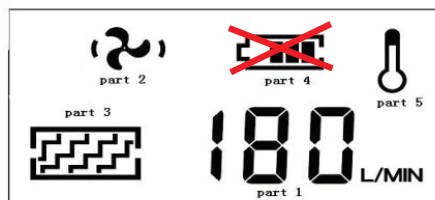

FIGURE 8 (NOT FOR CHARGING STATE INDICATING)

If the charger indicator light will not light up when connecting the charger to the battery, please check the battery's charge connector and the charger's cords and connectors.

4. After charging is completed, disconnect the battery charger from the mains supply.
5. Disconnect the battery from the battery charger.

NOTE: The particle filter must be changed if the battery operating time becomes too short.

CHECKING OF AIRFLOW AND CHECKING OF LOW AIRFLOW ALARM

The airflow and alarm system must always be checked before using.

1. Test air flow

The system is equipped with an air flow indicator. Connect the Air flow indicator to the breathing connector and press the "ON" button (FIGURE 9).



FIGURE 9

WARNING: Don't use the system if the ball is below the mark line. Check the filter and the battery and retest the air flow.

2. Test air flow alarm

Remove the breathing tube from the welding helmet, Press "ON" button. Cover the air outlet with your hand and wait about 15sec, the alarm will be heard and the red light on the PAPR unit will flash. The filter mark on screen will also flash (see FIGURE 10).

NOTE: If the alarm does not work, please change the PAPR unit



FIGURE 10

PAPR WELDING HELMET

WARNING!

Leave the contaminated area immediately if:

1. Any part of the system becomes damaged.
2. Airflow into the helmet decreases or stops.
3. Breathing becomes difficult.
4. Dizziness or other distress occurs.
5. You taste or smell contaminants or an irritation occurs.
6. At very high work rates, the pressure in this PAPR device may become negative at peak inhalation flow.

FITTING

- Adjust the waist belt and dual shoulder strap size, so that the U21014K unit sits easily and is accessible and comfortable on your hips.
- Pull down the face seal ring and put on the head top. Adjust the headgear to suitable tightness so that it will be stable on the head. The tightness of headgear can be adjusted by pushing and turning of the adjusting knob. See FIGURE 11 for details.
- Put on the helmet and adjust the headgear to suitable tightness so that it will be stable on the head.
- The face seal should rest against your face, with a comfortable pressure on your temples.
- If the face seal doesn't make contact with your face, you will not get sufficient sealing needed to offer the correct protection factor.
- Check that the facial unit is stable on the head and has no moving parts. Turn on the system and check there's no abnormal noise and no air leakage.

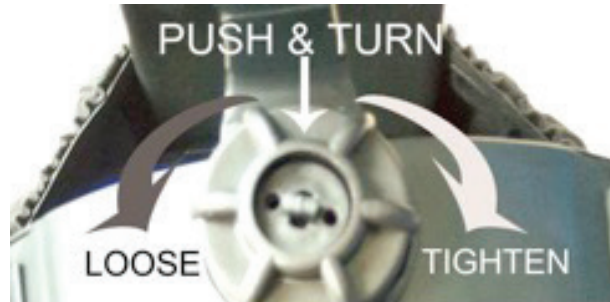
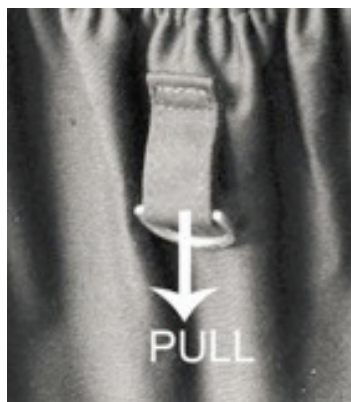

FIGURE 11

LCD AND OPERATION

LCD

There is a LCD display on U21014K unit to show the U21014K working condition (FIGURE 12).

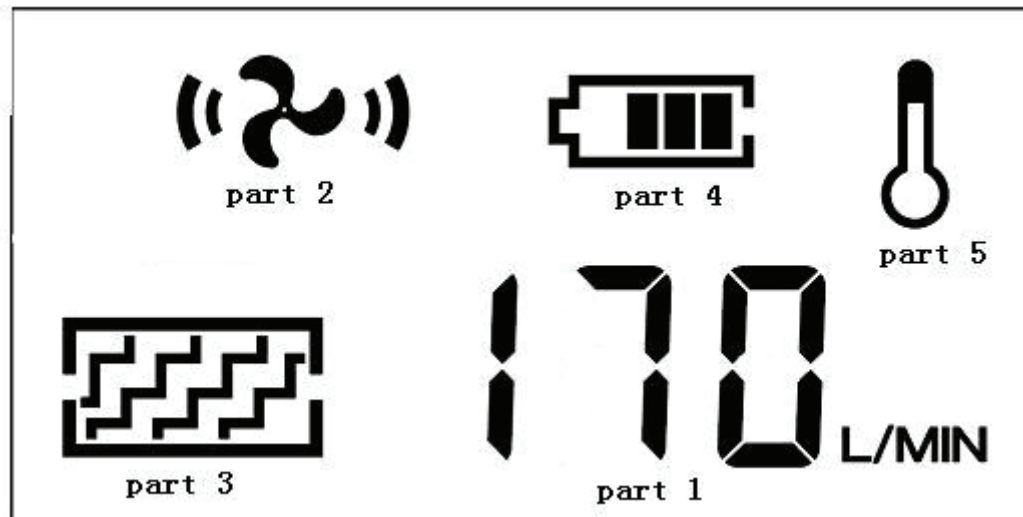

FIGURE 12

- **Part 1** shows the data of current air flow.
- **Part 2** shows the level of the airflow.
- **Part 3** shows the filter condition.
- **Part 4** shows the battery.
- **Part 5** shows the temperature of the battery.

Any of them will flash if U21014K malfunctions.

OPERATION

Start the PAPR unit by pressing the "on" button on the PAPR unit. The PAPR is working at level 1

Press the "on" button again. The system is working at level 2.

Press the "on" button again. The system is working at level 3.

Press the "on" button again. The system is working back to level 1.

Press the "off" button for at least 3 seconds, The PAPR is powered off.

NOTE: There are 3 levels of air flow. Level 1 is no lower than 165L/min, Level 2 is 200L/min, and Level 3 is 230L/min.

PAPR will shut down the entire circuit and switch to sleep mode if not used for more than 30 minutes. Press the "on" button to activate the system.

The PARR was tested in the temperature range of -5°C to +55°C and relative humidity less than 90%RH.

The PAPR must be operated in the temperature range of -5°C to +55°C and relative humidity less than 90%RH.

PAPR WELDING HELMET PARTS LIST

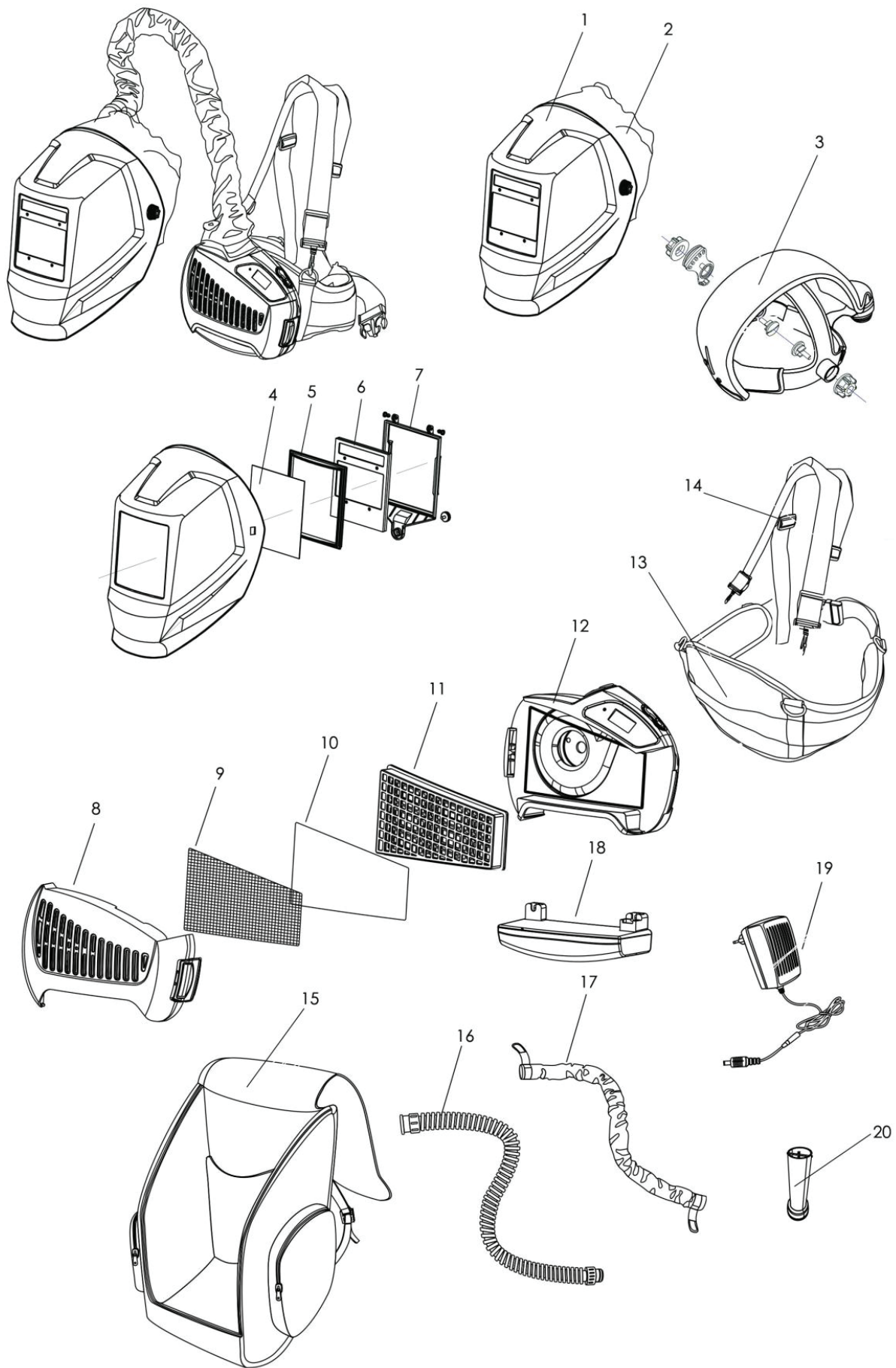

PAPR WELDING HELMET PARTS LIST



DRAWING NO.	PART NO.	DESCRIPTION	MFG DATE
1	P-01 01 003	Helmet Shell	
2	P-01 02 002	Face Seal	
3	P-02 01 001	Air duct	
4	PL-5002	Outer Protection Lens	
5		ADF Cradle	
6		Auto-Darkening Filter(ADF)	
7		Inner Protection Lens	
8	P-04 01 001	Filter Cover	
9	P-04 02 001	Spark Arrestor	
10	P-04 03 001	Pre-filter	
11	P-04 04 001	Filter	
12	P-04 05 001	Turbo Unit	
13	P-05 01 001	Waist Belt	
14	P-05 02 001	Shoulder Harness	
15	P-05 03 001	Carrying Bag	
16	P-06 01 001	Breathing Hose	
17	P-06 02 001	Anti-fire Cloth for Breathing Hose	
18	P-03 01 001	Rechargeable Battery	
19	P-06 03 001	Battery Charger	
20	P-06 04 001	Air Flow Tester	

PAPR WELDING HELMET

REPLACEMENT

REPLACING THE FILTER

The installed filter has a limited service life based on working conditions. When the filter mark on the screen flashes and the alarm rings, filter should be replaced. If the filter is installed but unused, it has a limited service life of 3 years.

1. Remove the filter cover by pressing in the latch of the filter cover (figure 19)
2. Remove the used filter by lifting it out from the filter cover.
3. Install a new filter in the filter cover. (NOTE: Unauthorized filter will void the warranty and expose the user to the risk of personal injury. Do not confuse the markings on a filter relating to any standard other than Australian/New Zealand standard AS/NZS 1716:2012 with the classification PAPR-P2 of U21014K device when used with this filter.)
4. Change the pre-filter if needed.
5. If necessary, clean or change the part arrestor (metal net) on the base of the filter cover.
6. Put back the filter cover, with the filter installed, by hooking the cover on the left side of the U21014K unit, and pressing the cover down so that the latch engages correctly.

WARNING: Check the expiry date of the unopened filter. DO NOT use it if it's expired.

Only the U21014K particle filter, gas filter and pre-filter can be used together with this system. Filters from other manufacturers should under no circumstances be used.

MAINTENANCE & STORAGE

Inspect the equipment daily, and always check it if any sign of malfunction occurs.

MAINTENANCE

- The PAPR unit must be checked regularly and must be changed if it is damaged or caused leakage.
- The filter must be changed if it is broken, or it is blocked and does not give enough airflow.
- The breathing tube must be changed if it is broken or has a crevasse.
- The battery must be charged when the low battery alarm rings.
- Use a soft cloth to wipe the external surfaces. Don't use water!
- The filter should be replaced together with the pre-filter.

STORAGE

- The PAPR must be stored in a dry, clean area, in the temperature range of -10°C to +55°C and relative humidity less than 90%RH.
- If the equipment is stored at temperature below 0°C, the battery must be allowed to warm up to achieve full battery capacity. The equipment must be protected from dust, particles and other contamination.
- If the equipment is not used for a long time, the battery should be full charged, removed from PAPR unit and store separately.

TROUBLESHOOTING

PROBLEM	PROBABLE CAUSE	ACTION
LCD defective code E01 and red light flashes	<ul style="list-style-type: none"> Motor is stuck Motor damage Blower structure failure caused by outer force Circuit failure 	Check and remove physical failure and restart the system. Return to dealer if LCD still shows E01
LCD defective code E02 and red light flashes	<ul style="list-style-type: none"> Motor damage Motor impeller rubs blower shell Circuit overheating 	Check and remove physical failure and restart the system. Return to dealer if LCD still shows E02
LCD battery icon flashes Warning sound Red light flashes	<ul style="list-style-type: none"> Low battery 	Charge the battery
LCD filter icon flashes Warning sound Red light flashes	<ul style="list-style-type: none"> Filter blocked Hose blocked 	<ul style="list-style-type: none"> Remove obstruction, change the filter Clean hose
LCD temperature icon flashes Warning sound Red light flashes	<ul style="list-style-type: none"> High temperature 	Stop working and rest
No flow, no alarm	<ol style="list-style-type: none"> 1. No power 2. Battery contact damaged 	<ul style="list-style-type: none"> Charge the battery Check battery contact
Battery run time is too short	<ol style="list-style-type: none"> 1. Battery is not fully charged 2. Filter is blocked 3. Battery is damaged 	<ul style="list-style-type: none"> Charge the battery Remove obstruction, Change filter Change battery
Air supply to hood smells unusual	<ol style="list-style-type: none"> 1. Filter broken 2. Hose broken 3. ADF helmet broken 	<ul style="list-style-type: none"> Leave current area immediately. 1. Change filter 2. Change hose 3. Change ADF helmet
Supply insufficient air to hood	<ol style="list-style-type: none"> 1. Breathing tube break off 2. Breathing tube broken 3. Filter is blocked 	<ol style="list-style-type: none"> 1. Check hose connect to hood and PAPR unit 2. Change breathing tube 3. Remove obstruction, change filter

PAPR WELDING HELMET

SPECIFICATION

Size (Blower Assembly)	9-2/5 x 6-1/2 x 2-3/4 in. (240 x 165 x 70 mm)
Weight	2.4KG
Air Filter	1*P2
Air Flow	Level 1: >=165L/min Level 2: 200L/min Level 3: 230L/min
Noise Level	Max 73dB
Operating Temperature	23°C to 131°C (-5°C~55°C)
Storage temperature	14°C to 131°C (-10°C~55°C)
Battery Type	Rechargeable Li-ION 4400mAh
Expected Battery Operation Time	Level 1>8h Level 2>6h Level 3>4h
Battery Charging Time	3.5 Hours
Battery Life	500 Charges Run Time Dependent On Air Flow Rate and Filter Load.
LCD Display	Air flow level and data Battery capacity Filter status
Belt Size	35-2/5 x 51-2/5 in. (900mm to 1300mm)

MARKING EXPLANATION

POWERED FILTERING DEVICE:

Australian/New Zealand standard AS/NZS 1716:2012 Respiratory protective devices - Powered filtering devices incorporating a helmet or hood – Requirements, testing, marking PAPR-P2 classification of the unit. "P2" defines the level of protection "P"=Particle filter.

PAPR WELDING HELMET



WARNING SOUND INDICATION

Each grid stands for a period of 100ms. Grey is the beep sound and blank grid is a quiet period. If several continued grids are in grey then there's a continuous beep sound.

For example, when the current is overloaded, the system sounds like beep~ beep~beep~~~~.

100ms per grid											
	0	1	2	3	4	5	6	7	8	9	10
Install the battery	Grey										
Turn on the system	Grey										
Change the air flow speed	Grey										
Turn off the system	Grey	Grey	Grey	Grey	Grey						
Current overload	Grey		Grey		Grey	Grey	Grey	Grey	Grey		
Air outlet jam	Grey		Grey	Grey	Grey	Grey	Grey				
Over heat	Grey		Grey		Grey		Grey	Grey	Grey	Grey	
Low battery	Grey		Grey								
Filter jam	Grey		Grey		Grey						



Read instructions before use

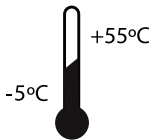

The system should be operated in the temperature range of -5°C to +55°C



The system should be operated in an environment with relative humidity less than 90%RH

WARRANTY

- The U21014K Blower unit is guaranteed for a period of 12 months from date of purchase against mechanical or electrical defects.
- The U21014K battery is guaranteed for a period of 6 months from the date of purchase.
- The company undertakes to exchange or repair without charge, any part found to be defective within this period. Alternatively and at its discretion. The company may replace.

This guarantee is subject to:

- The U21014K unit has been used solely for the purpose for which it is intended.
- The U21014K unit has not been subject to misuse, accident, modification or repair.

N.B. In the event of a claim, contact the retailer from which the U21014K unit was purchased. The guarantee does not cover normal wear and tear this guarantee does not affect your legal rights.

UNIMIG®

Welding Guns Of Australia Pty Ltd

ABN: 14 001 804 422

PO Box 3033, Lansvale NSW 2166, AUSTRALIA

112 Christina Rd, Villawood, NSW 2163

Phone: 1300 864 644

Fax: (02) 9780 4244

Email: sales@unimig.com.au

www.unimig.com.au

© Welding Guns Of Australia PTY LTD 2019