



QUON 8-Litre

CG 30 360

8x4







SPECIFICATIONS

Power:	263 kW (357 PS) @ 2200 rpm
Torque:	1428 Nm (1055 lb.ft) @ 1200 rpm
Transmission:	Allison 3200 series ESCOT-VI automated manual transmission (AMT)
Rear Suspension:	Leaf spring or electronically controlled air suspension
Wheelbase:	Refer weights and dimensions table
GVM:	28,500 kg - Allison 30,000 kg - ESCOT
GCM:	28,500 kg - Allison 38,000 kg - ESCOT

Note: CG 30 360 shown may not be representative of actual vehicle.

QUON UNIQUE FEATURES

-  **SMART FUEL EFFICIENCY AND RESPECT FOR THE ENVIRONMENT**
GH8 engine: fuel efficient, powerful and clean.
-  **SMART UPTIME**
Quon has been designed to further optimise uptime, with superior reliability and increased maintenance intervals.
-  **SMART SAFETY**
Active safety with mechanical and electronic features throughout.
-  **SMART PRODUCTIVITY**
Light weight chassis helping to maximise payload.
-  **SMART DRIVABILITY**
The cabin has been designed with the user's comfort in mind, with outstanding ergonomics and visibility allowing the driver to concentrate on driving.

GENERAL SPECIFICATIONS

SAFETY

Passive Safety:	Highly rigid cabin Side door beams Front underrun protection system (FUPS) SRS driver steering wheel airbag Driver side seat belt with pre-tensioner Steering wheel & column with impact absorption function
Active Safety:	Traffic Eye Brake System Traffic Eye Cruise Control (ESCOT only) LDWS (Lane Departure Warning System) Electronic Stability Control (UDSC) Automatic Hill Start Assist (HSA) (ESCOT only)
Basic Safety:	LED Headlamps (low beam) Disc brakes Anti Locking Brake System Emergency Braking System UD Extra Engine Braking (UD EEB) Safe Brake Blending Immobiliser Two-step entry & exit

ENGINE

Model:	GH8F
Description:	6 cylinder, 4 stroke diesel engine
Displacement:	7,698 cc
Bore x stroke:	110 mm x 135 mm
Compression ratio:	17.5:1
Max. Power (ECE Net):	263 kW (357PS) @ 2,200 rpm
Max. Torque (ECE Net):	1,428 Nm (1,050 lb.ft) @ 1,200 rpm
Max. governed engine speed:	2,400 rpm

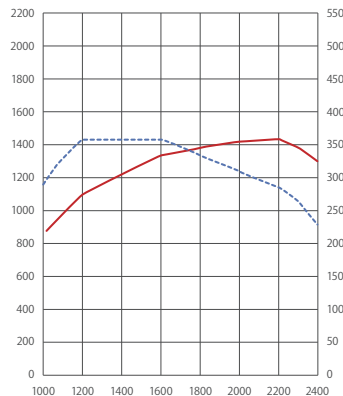

FUEL AND INTAKE SYSTEM

Fuel capacity:	4500mm WB - 190 litres 5200mm & 5700mm WB - 400 litres
Injection type:	High pressure common rail direct fuel injection system
Filtration:	Chassis mounted primary filter and engine mounted secondary filter

EMISSION CONTROL

Emission standard:	pPNLT (equivalent to Euro 6 emission requirements)
Adblue capacity:	4500mm WB - 30 litres 5200mm & 5700mm WB - 50 litres
Exhaust system:	RHS chassis mounted box muffler

ELECTRICAL

Power:	24 volt, negative ground system
Battery capacity:	2 x 12 volt 135 Ah batteries
Alternator:	110 amp

TRANSMISSION - ALLISON

Make:	Allison
Model:	3200 Series
Description:	6 speed fully automatic with Gen 5 adaptive shift
Shift type:	Push button shift selector
Gear ratios:	1st 3.49 2nd 1.86 Rev 1 5.03 3rd 1.41 4th 1.00 5th 0.75 6th 0.65
PTO capability:	DIN 5462; 650 Nm capacity

TORQUE CONVERTER

Make:	Allison
Model:	TC-418
Stall torque ratio:	1.98

TRANSMISSION - ESCOT

Make:	UD Trucks
Model:	ESCOT-VI (AT2612F)
Description:	Automated manual transmission (AMT)
Shift type:	12 forward & 2 reverse gears
Gear ratios:	Electronic shifter with fully automatic or manual control
	1st 14.94 7th 3.44 2nd 11.73 8th 2.70 3rd 9.04 9th 2.08 4th 7.09 10th 1.63 5th 5.54 11th 1.27 6th 4.35 12th 1.00 Rev 1 17.48 Rev 2 13.73
	PTO capacity: 1000 Nm @ 70% or 90% (PTR-D)

FRONT AXLE AND SUSPENSION SYSTEM

Ground capacity:	13,000 kg
Axle type:	Reverse Elliot I-Beam
Suspension:	Parabolic leaf spring with shock absorbers
Spring dimensions:	90mm x 1460mm
Spring constant:	347.7 N/mm
Load distribution:	Front axles - loadshare

REAR AXLE AND SUSPENSION SYSTEM

Ground capacity:	20,000 kg
Axle type / model:	Single reduction, hypoid gear
Final reduction ratio:	Allison - 5.67, 6.17 ESCOT - 3.78, 4.13, 4.50
LEAF SUSPENSION:	
Description:	Multi-leaf spring suspension, rubber cushions
Leaf dimensions:	75mm x 1380mm
AIR SUSPENSION:	
Description:	8 air bag
Shock absorbers:	2 telescopic double acting
Road friendly certification number:	RF2099 (air only)
Control system:	Electronic Controlled Air Suspension with remote control mounted in cab (ECAS4)

BRAKES

Type:	Electronic braking system (EBS) with disc brakes on all axles
Front/Rear:	430 mm rotors / 430 mm rotors
Park brakes:	Hand-operated pneumatic spring park brake on drive axles
Auxiliary brake:	Exhaust plus engine compression type (EEB)
Trailer connections:	Air and electrical connections to rear of chassis

STEERING

Type:	Recirculating ball and screw with hydraulic assist
Steering gear ratio:	24.1 - 26.8 : 1
Column:	Adjustable, tilt and telescopic control
Steering wheel:	460 mm diameter with ignition key steering lock

WHEELS & TYRES

Wheels:	8.25in x 22.5in rim with 165mm offset and ISO 10 stud pattern (335mm PCD)
Front tyres:	295/80 R22.5 Bridgestone R150Z
Rear tyres:	11R 22.5 Bridgestone MZ11AZ
Spare tyre:	295/80 R22.5 Bridgestone R150Z
Agitator Spec (P):	11R 22.5 Yokohama Y785R-16PR (Front & Rear)

FRAME

Width:	850 mm
Side rail dimensions:	300 mm x 90 mm x 8 mm
Material:	Rolled high tensile carbon steel
Tensile strength:	600MPa / 600N/mm ²

STANDARD DRIVER AIDS

Warning systems:	Visual warning lamps with audible warning tones, plus written warnings displayed on LCD screen
Driver assistance:	Driver information including: date, time, oil pressure, voltmeter, trip information Electronic stalk mounted cruise control GPS satellite navigation with HERE® truck mapping

INTERNAL CABIN

Lighting:	Dual ON/OFF/DOOR interior lights Interior neon cabin lamp
Seating capacity:	Three
Driver's seat:	ISRI 6860/875 with integrated seat belt
Passenger seat/s:	Assistant seat with adjustable head rest Foldable centre seat
Sleeping capability:	ADR 42/04 compliant sleeper bunk with mattress
Side windows:	Power operated door glass
Security:	Remote central locking with immobiliser
Air conditioning:	Fully automatic climate controlled airconditioning with recirculation filter

Multimedia unit:	8" capacitive touchscreen CD/DVD player with truck specific satellite navigation, digital radio, Internet radio (requires phone data), USB port, auxiliary port, micro SD slot, phone tethering, bluetooth, PDF reader, and is Wi-Fi enabled. Bluetooth hands free operation with Apple & Android connectivity
Storage:	Multiple in-cab compartments
Power outlet:	24 volt 240W & 12 volt 120W in dash
DIN accessory fitment:	Two DIN sized compartments
Floor covering:	Vinyl

EXTERNAL CABIN

Cab Description:	Forward control, pressed steel construction
Mounting type:	Full floating, 4 bag air suspended cab with 4 dual acting shock absorbers and dual automatic height control valves
Cab paint:	Standard – "Polar White"
Inspection points:	Back of the cab and front panel
Bumper type:	3 piece with steel corner panels
Mirrors:	Heated & electrically operated main mirrors with flat glass, wide vision & passenger-side downward facing spot mirrors
Lamps:	LED head lamps (low beam) Bumper mounted fog lamps Roof mounted clearance lights
Wipers:	Triple arm, 2 speed wipers with variable intermittent operation & integrated washers
Reversing system:	Reverse beeper and digital infrared camera with microphone

UD TELEMATICS (FLEET MANAGEMENT)

Telematics hardware:	In-cab GSM and GPS unit with SIM-card connected to roof antenna
Subscription:	12 months included
Packages:	Fuel and Environment Positioning Total operational time and distance Average speed and fuel consumption Total CO ² emission Vehicle utilisation Anticipating & braking Engine & gear utilisation Speed adaptation Time idling (standstill)
Key Reports:	

FACTORY OPTIONAL EQUIPMENT

Tyres:	275/70 R22.5
Wheels:	Alcoa aluminium wheels
Rear engine PTO:	1 o' clock
Transmission PTO:	Top mount, 1 o'clock
Safety:	Driver Alert System
UD Telematics:	Positioning+ package
Cab paint:	Custom paint colours
Windows:	Passenger-side door safety window Rear cab quarter windows

WEIGHTS AND DIMENSIONS (approx.)

Variant	Model	WB Code	GVM*	GCM	Front Tare ^{1,3}	Rear Tare ^{1,3}	Total Tare ^{1,3}	WB	TWB	OL	OW	OH	FT ⁴	RT ⁴	FW	AS	FOH	ROH	RFL	BOC	CA	GC	FHF	FHR	Turning Radius
Air	CG30360PAA	P	28,500 kg - Allison 30,000 kg - ESCOT	28,500 kg - Allison 38,000 kg - ESCOT	5432	2605	8037	4500	5185	8451	2490	2990	2062	1851	850	1370	1392	1760	2445	735	3765	201	1047	1059	8.74
	CG30360TAA	T			5465	3196	8661	5200	5885	9917		2985	2044	1833				2510	3195		4465	200	1042	1058	9.83m
	CG30360VAA	V			5527	3163	8690	5700	6385	11567		2985	2044	1833				3660	4345		4965	200	1041	1058	10.7m
Leaf	CG30360PAL	P			5263	2818	8081	4500	5185	8337		2990	2062	1851				1760	2445		3765	262	1048	1092	8.74
	CG30360TAL	T			TBD		5200	5885	9917	2985		2044	1833	2510				3195	4465		259	1042	1092	9.83m	
	CG30360VAL	V			TBD		5700	6385	11566	2985		2044	1833	3660				4345	4965		259	1041	1092	10.7m	

*Rated GVM and axle capacities are subject to Federal, State and Territory legal requirements.

¹ Mass is an estimation only based on standard model, includes fluids (not Diesel fuel or AdBlue) excludes driver and tools. Subject to ± 3% tolerance.

² Based on vehicle with standard wheels and tyres.

³ For alloy rims deduct 56kg from Front Tare and deduct 111kg from Rear Tare.

⁴ For alloy rims add 18mm to both FT and RT measurements.

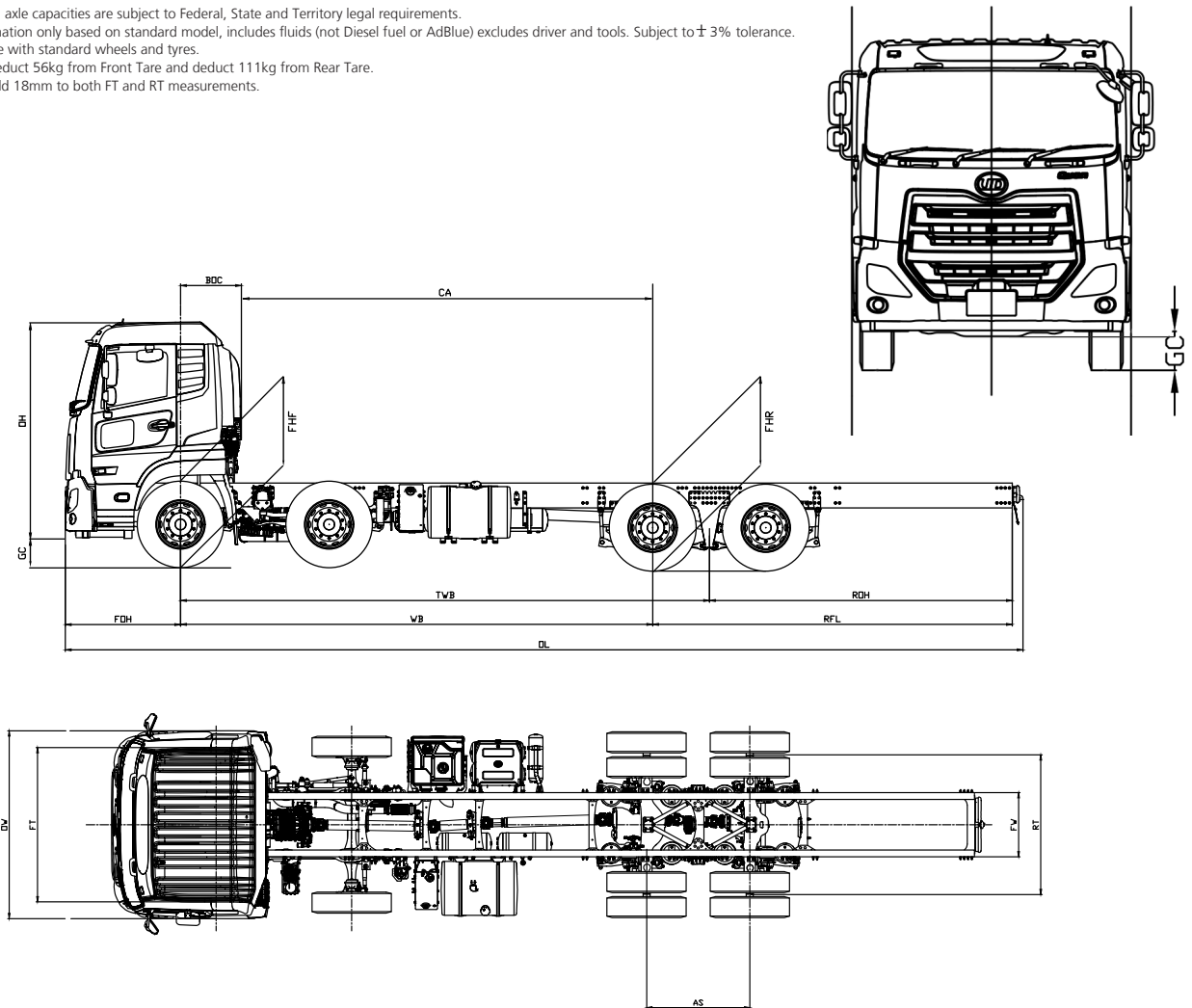

WARRANTY

Standard warranty⁺ 36 months / 500,000 kms
Cab corrosion warranty⁺ 36 months / unlimited kms
Extended warranty⁺⁺ 60 months / 500,000 kms

⁺For details refer to your UD Trucks New Vehicle Warranty brochure

⁺⁺Purchased by the owner and covers selected factory items only. For details refer to your UD Trucks New Vehicle Warranty brochure