

MAXTECH

PNP100x30-Ø8 HL36,5

EAN 4031582320572

Wheel centre made of Polypropylene, Tread: Polyurethane, foamed, precision ball bearing



BETTER MOBILITY. BETTER LIFE.



Picture may differ from original product

Technical Data

Wheel diameter	100 mm
Width of Tread	30 mm
Axle Hole-Ø	8 mm
Hub length	36.5 mm
Temperature	- 20 / + 60 °C
Standard	EN 12530
Weight	0.14 kg
Hardness of tread	Shore A 70
Load capacity	50 kg
Load capacity (static)	120 kg

Dimensions

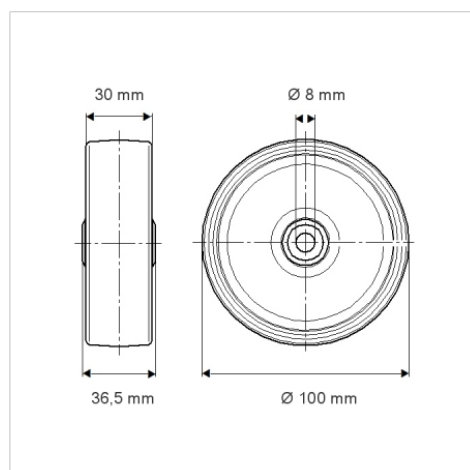

Advantages at a glance

Roll performance	● ● ● ○ ○
Movement noise	● ● ● ○ ○
Attrition	● ● ● ○ ○
Corrosion resistance	● ● ● ○ ○