

ETC One Plus Network Communicator

Installation and Operation Manual



LIMITED WARRANTY

The manufacturer offers the customer a 24-month functional warranty on the instrument for faulty workmanship or parts from date of dispatch from the distributor. In all cases, this warranty is valid for 36 months from the date of production. This warranty is on a return to factory basis.

The manufacturer does not accept liability for any damage caused by instrument malfunction. The manufacturer accepts no responsibility for the suitability of the instrument to the application for which it was purchased.

Failure to install, set up or operate the instrument according to the instructions herein will void the warranty.

Only a duly authorized representative of the manufacturer may open your instrument. The unit should only be opened in a fully anti-static environment. Failure to do so may damage the electronic components and will void the warranty.

The greatest care has been taken to manufacture and calibrate your instrument. However, these instructions do not cover all possible contingencies that may arise during installation, operation or maintenance, and all details and variations of this equipment are not covered by these instructions.

For additional information regarding installation, operation or maintenance of this instrument, contact the manufacturer or your local representative or distributor.

WARNING

Read the instructions in this manual before performing installation, and take note of the following precautions:

- ⇒ Ensure that all incoming AC power and other power sources are turned OFF before performing any work on the instrument. Failure to do so may result in serious or even fatal injury and/or equipment damage.
- ⇒ Before connecting the instrument to the power source, check the labels on the back of the instrument to ensure that your instrument is equipped with the appropriate power supply voltage, input voltages and currents.
- ⇒ Under no circumstances should the instrument be connected to a power source if it is damaged.
- ⇒ To prevent potential fire or shock hazard, do not expose the instrument to rain or moisture.
- ⇒ The secondary of an external current transformer must never be allowed to be open circuit when the primary is energized. An open circuit can cause high voltages, possibly resulting in equipment damage, fire and even serious or fatal injury. Ensure that the current transformer wiring is secured using an external strain relief to reduce mechanical strain on the screw terminals, if necessary.
- ⇒ Only qualified personnel familiar with the instrument and its associated electrical equipment may perform setup procedures.
- ⇒ Do not open the instrument under any circumstances when it is connected to a power source.
- ⇒ Do not use the instrument for primary protection functions where failure of the device can cause fire, injury or death. The instrument can only be used for secondary protection if needed.

Read this manual thoroughly before connecting the device to the current carrying circuits. During operation of the device, hazardous voltages are present on input terminals. Failure to observe precautions can result in serious or even fatal injury or damage to equipment.

All trademarks are property of their respective owners.

Copyright SATEC Ltd. © 2008

Table of Contents

Chapter 1 General Information	4
Chapter 2 Installation	5
Mechanical Installation	5
Wall Mounting.....	6
DIN Rail Mounting.....	6
Add-On Module Mounting	7
Electrical Installation	8
Power Source Connection	8
Communication Port Connection	8
Internet Connections.....	12
Chapter 3 Operating the ETC ONE PLUS	13
Controls and Indicators	13
PROG Button	13
LED Indicators	13
Modes of Operation.....	14
Operational Mode.....	14
Program-Service Mode	14
Using the ETC ONE PLUS.....	14
Slave Network Connection	14
Master Network Connections.....	14
ETC I Communication Setup	15
ETC I COM1 setup.....	15
ETC I COM2 Ethernet setup	16
ETC I COM2 GPRS setup.....	18
Setting Up eXpertPower Client	19
Using PAS Software.....	20
Configuration Database	20
Setting up Communications	20
Setting Up the ETC ONE PLUS.....	21
Authorization	22
Chapter 4 Setting Up the ETC ONE PLUS	23
Changing the Password and Security	23
Changing Time and Date	23
Configuring Local Time Settings	24
Configuring Device Routing Table.....	25
Chapter 5 Upgrading Device Firmware.....	26
Appendix Technical Specifications	28

Chapter 1 General Information

The *ETC I* Pass-through MODBUS gateway Communicator is a MODBUS Master/Slave gateway that connects multiple serial RS-485/422 devices to the Internet via a local Ethernet network or via public Cellular communication network.

The Pass-through packet-forwarding gateway will transfer data from/to ETHERNET or Cellular module to/from serial communication port COM1.

COM1 shall operate as a Client/Master and COM2, which is tied to Ethernet or Cellular network, shall be configured with its IP address to route data server to predefined MODBUS Slave devices (MODBUS address: from 1 to 31).

Features:

- COM1 as RS-485 master ports for connecting slave devices to serial networks
- COM2 as Ethernet 10/100Base-T port communicating to the IP network
- Or COM2 as CELLULAR modem port communicating to the IP network
- Table top, DIN Rail or wall-mounting options
- 120/240V AC/DC or 12/24 VDC operation

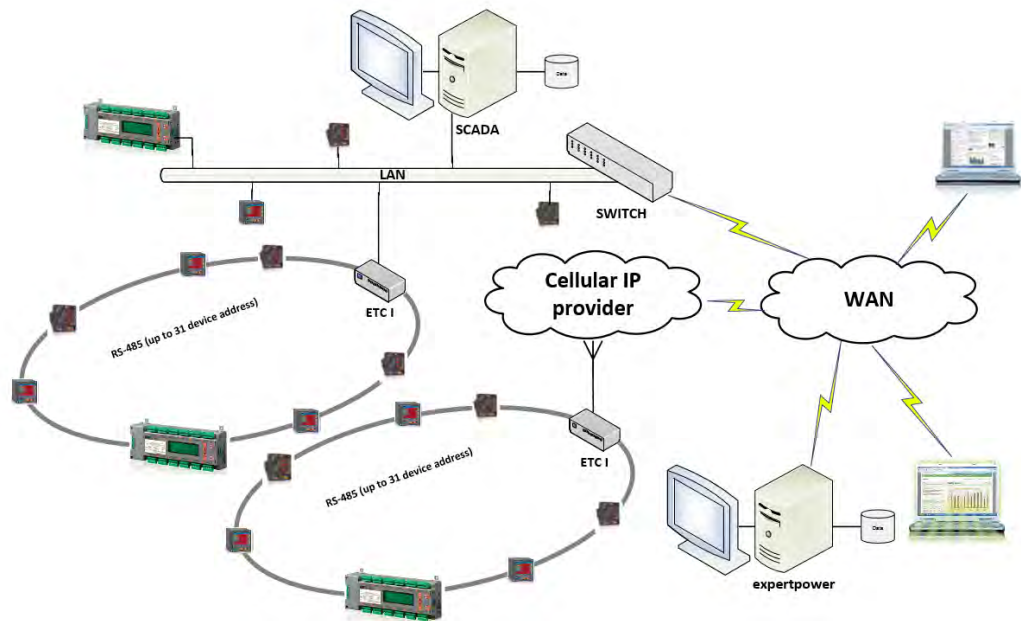

Chapter 2 Installation

Mechanical Installation

Refer to the figures provided in this section to properly perform the mechanical installation.

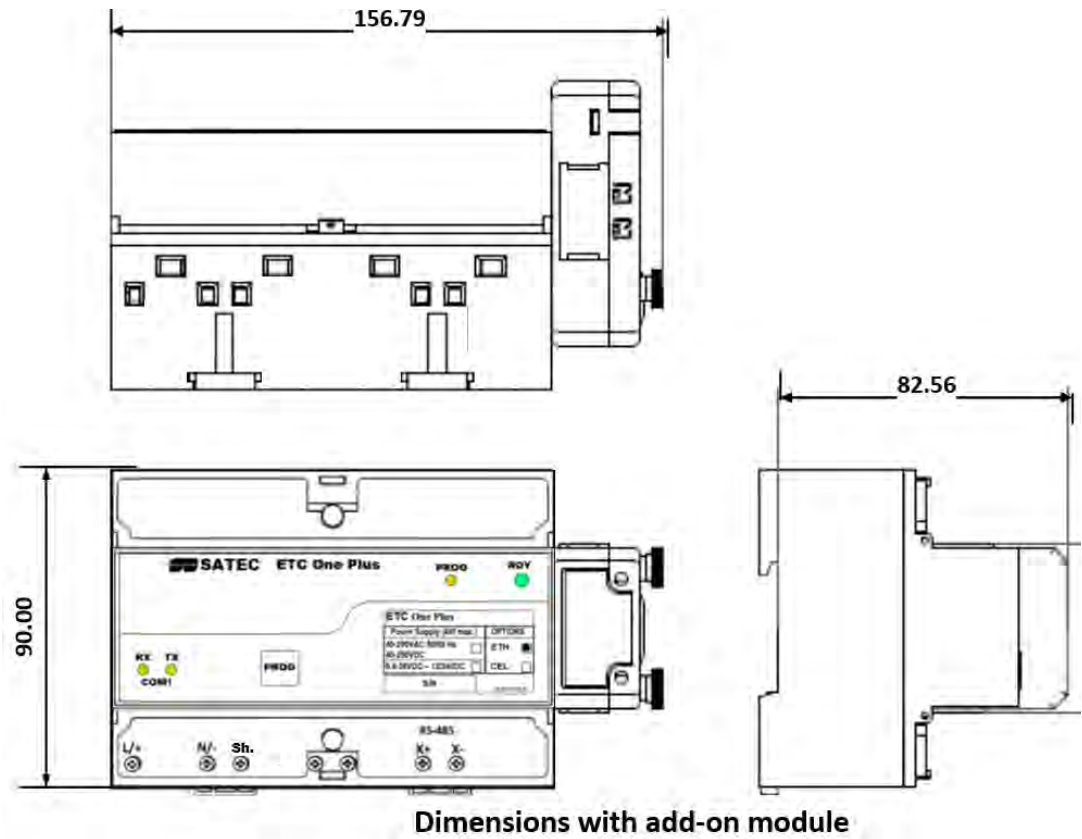

Figure 2-1 ETC ONE PLUS Dimensions

Wall Mounting

To mount the network communicator on the wall:

1. Position the device on the wall according to hole locations as shown in figure 2-2
2. Affix the device using washers and nuts.

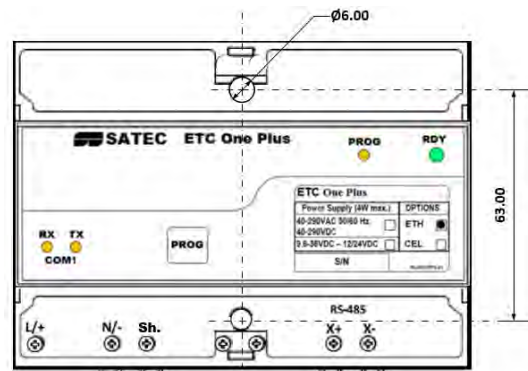

Figure 2-2 Surface mounting

DIN Rail Mounting

The ETC One Plus can be mounted on a standard 35-mm DIN rail as shown in figure 2-3

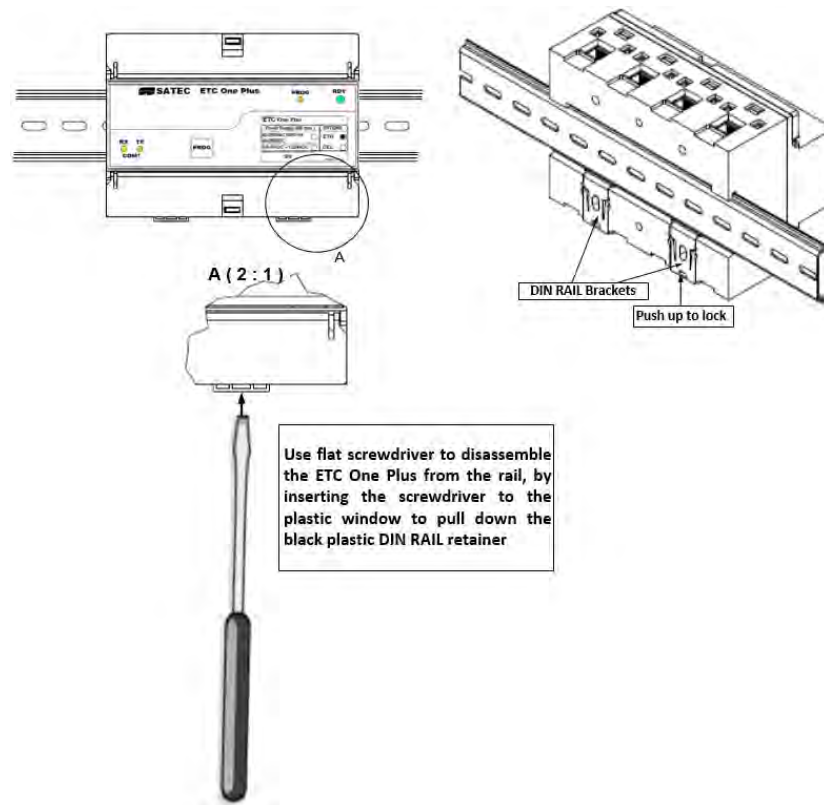

Figure 2-3 DIN Rail mounting

Add-On Module Mounting



Before Add-On Module installation ensure that all incoming power sources are shut OFF. Failure to observe this practice can result in serious or even fatal injury and damage to equipment.

1. Turn off the ETC One Plus (ETC I) power supply.
2. Remove the module connector cover from the ETC I to access the module connector as shown in figure 2-4 below

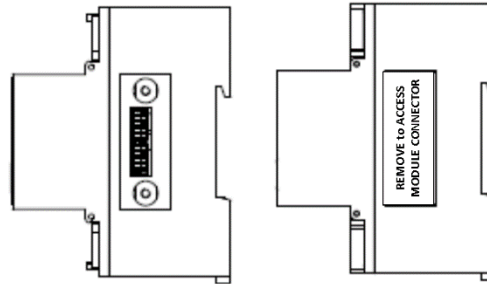

Figure 2-1. ETC I module connector location

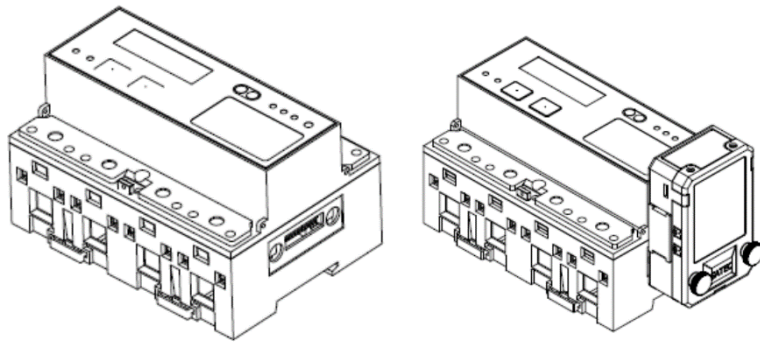

Figure 2-2. ETC I module assembly

Electrical Installation



The equipment installation shall conform to the following instructions:

- a) a switch or circuit-breaker shall be included in the building installation;
- b) It shall be in close proximity to the equipment and within easy reach of the OPERATOR;
- c) It shall be marked as the disconnecting device for the equipment.

Before installing, ensure that all incoming power sources are shut OFF. Failure to observe this practice can result in serious or even fatal injury and damage to equipment.

Power Source Connection

Before connecting your device to the power source, check the label on the the device to ensure that it is equipped with the appropriate power supply.

AC power supply: Connect the line wire to terminal L/+ and the neutral wire to terminal N/-.

DC power supply: Connect the positive wire to terminal L/+ and the negative wire to terminal N/-.

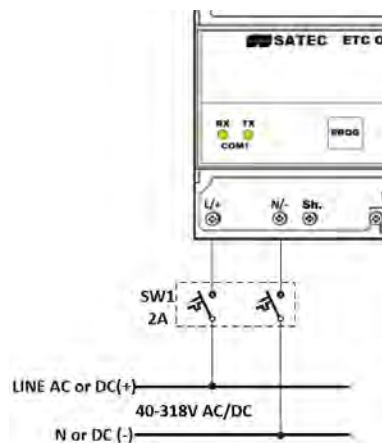

Figure 2-5 Power Source Connection

Communication Port Connection



Before installing the Communication Module, ensure that all incoming power sources are shut OFF. Failure to observe this practice can result in serious or even fatal injury and damage to equipment.

Two communication ports are available on the ETC I:

- **COM1 (master):** RS-485, devices side
- **COM2 (slave):** network side
 - Ethernet 10/100BaseT
 - CELLULAR - 2G/3G
 - RS-232 or RS-422/485

The COM1 - RS485 gateway port is used for connecting the ETC ONE PLUS to the RS-422/RS-485 slave network with up to 32 devices. For device COM port setup, see [Communication Setup](#) in Chapter 3.

The COM1 port can also be used as a slave port to communicate with PAS™.

COM1 RS-485 Connection

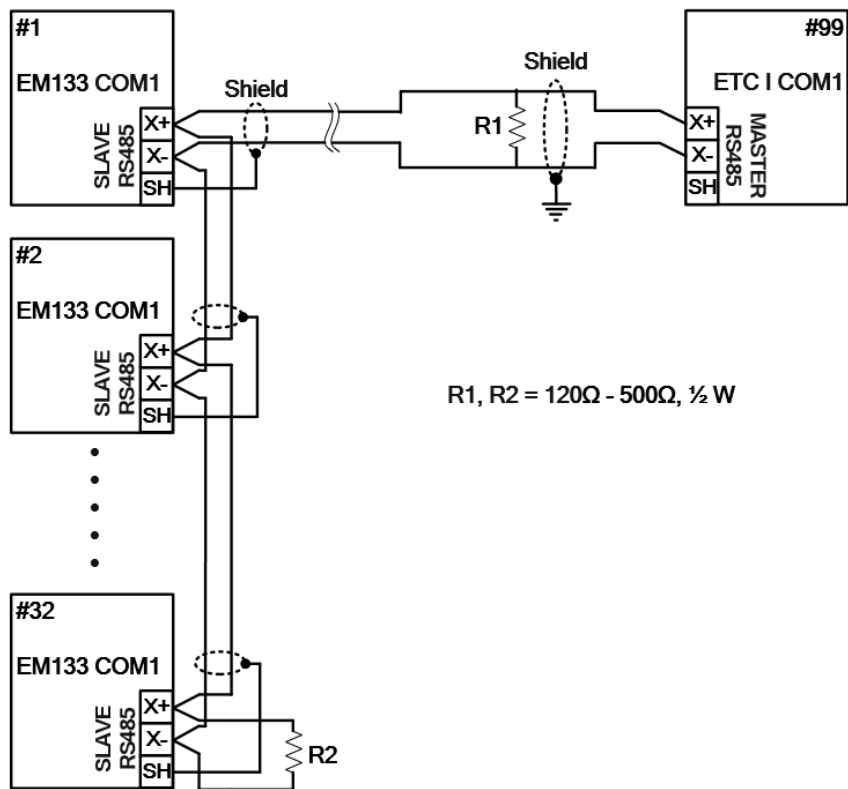
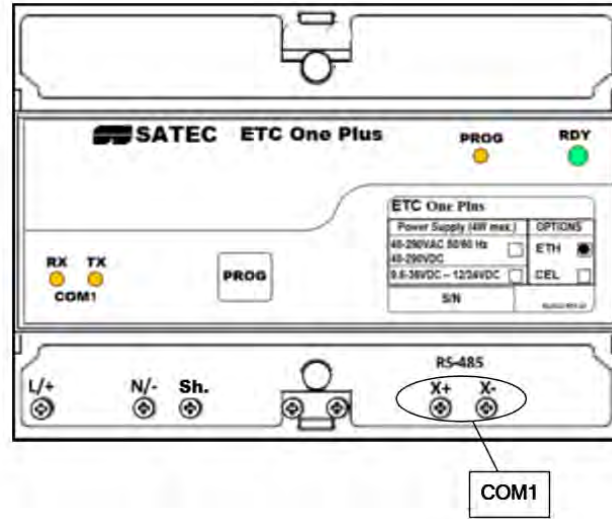

Figure 2-6 COM1 RS-485 2-Wire Connection

COM2 ETHERNET Connection

Plug the end of the Ethernet cable that came with your device into the wall Ethernet jack or into the Ethernet hub jack, and the other end into the RJ45 jack at the front of the ETC ONE PLUS ETHERNET module.

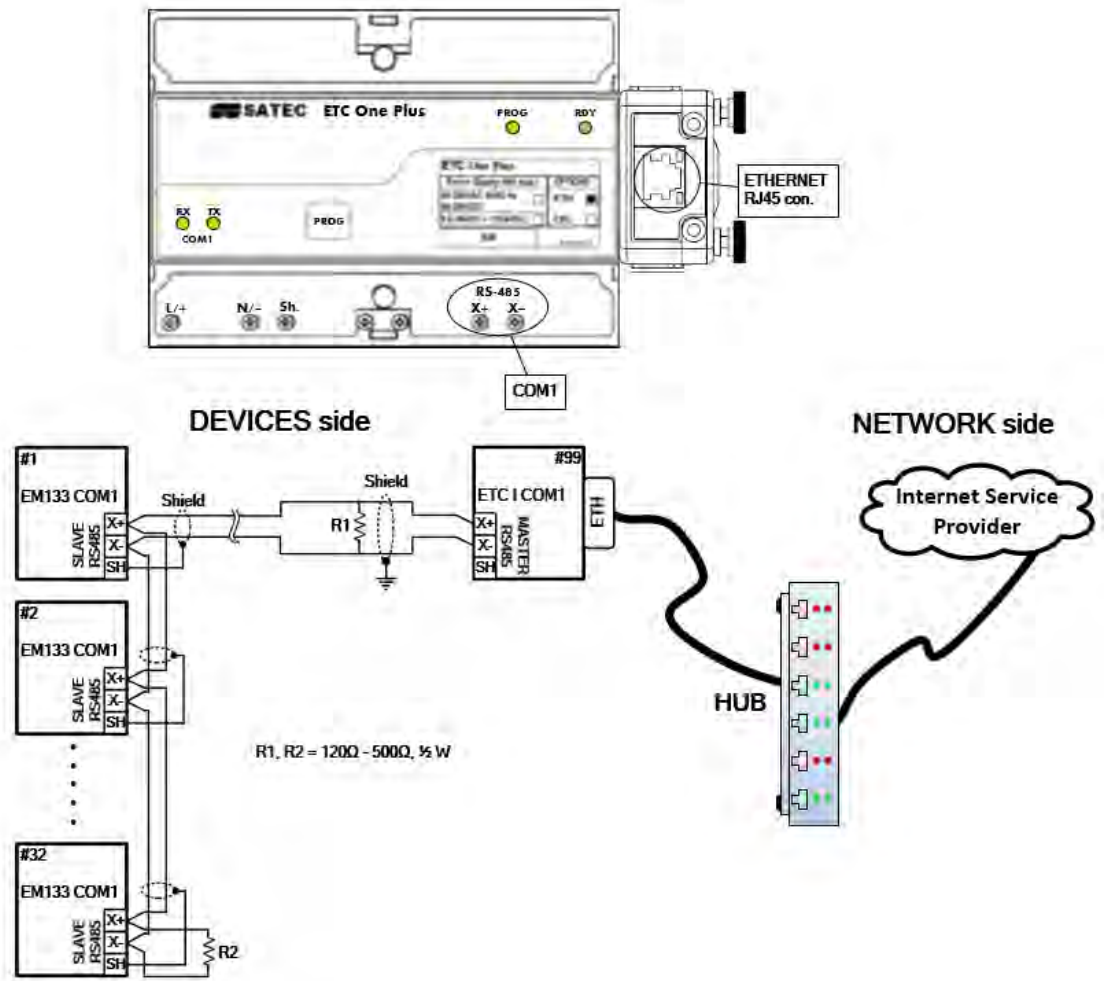

Figure 2-7 Serial and Ethernet Connections

COM2 CELLULAR connection

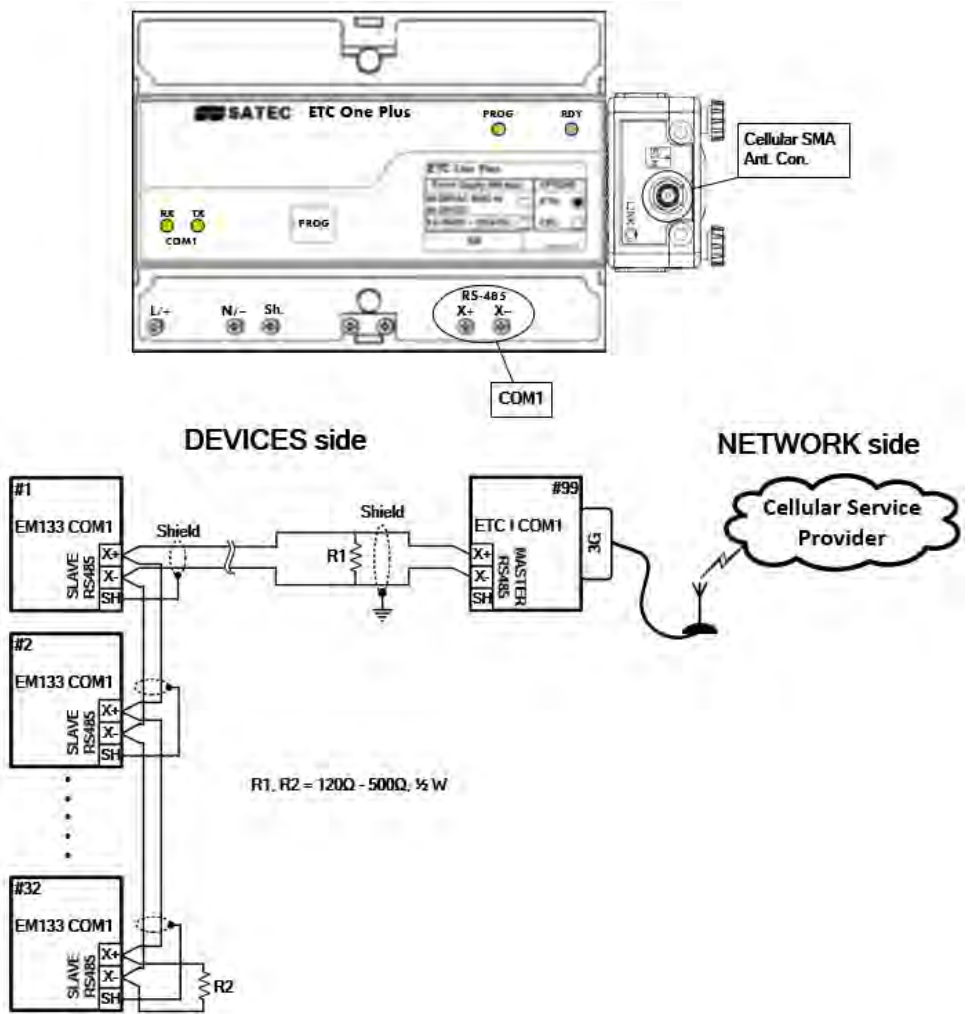

Figure 2-8 Serial and Cellular (3G) Connections

Internet Connections

The ETC ONE PLUS is connected to the Internet either via a local Ethernet network, or via public Cellular Network connection.

⚠ Connecting a device with the factory-set IP address to the Ethernet network can disrupt communications if the IP address exists on the network. Change the IP address in your ETC ONE PLUS as instructed in Section 4 before connecting a device to the network.

See [Internet Connections](#) in Chapter 3 and [configuring the Network](#) in Chapter 5 for instructions on how to program your device for networking via Ethernet.

Chapter 3 Operating the ETC ONE PLUS

Controls and Indicators

PROG Button

The ETC ONE PLUS has a PROG Button that puts the device into program mode for local servicing and programming.

To enter to PROGRAMMING mode, press the PROG button for at least 3 second during device "POWER UP", until the PROG yellow LED turns ON (see PAS in Chapter 4 for instructions).

To return to NORMAL mode from PROGRAMMING mode, press the PROG button for at least 3 second until the PROG yellow LED turns OFF

LED Indicators

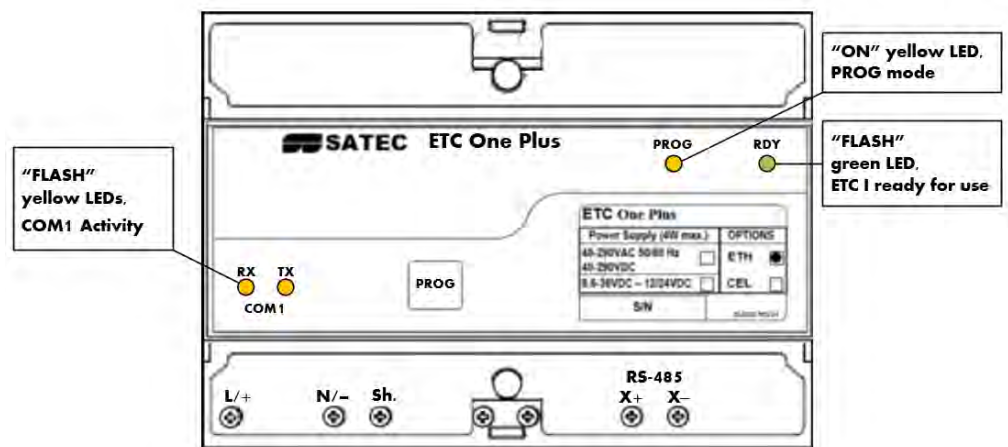

Figure 3-1 Indicator LEDs

The ETC ONE PLUS has three yellow device status LEDs and one green device status LEDs that show the present device status and activity on communication ports.

The ETC ONE PLUS has four status indicator LEDs that show present device operation status and give diagnostics indication as described in table below.

LED Name	Color	Status	Description
RDY	Green	2 sec Off	After Power up or Reset, the LED is Off
		Flashing 1/2 sec On, 1/2 sec Off	Device operational and is functioning normally.
		Flashing 2 flashes, 1 sec Off	Device is in the Service Mode and is not operational.
		On or Off continuously	A critical error has occurred - the device is not operational. Device servicing is required. For more information, see Diagnostics Mode below.
PROG	Yellow	Off	Device is in Normal operation mode
		On	Device is in Programming/service operation mode
COM1	Yellow	RX/TX Off	No communication activity on COM1 port
		RX/TX Flashing	Indicate communication activity on COM1 port

Modes of Operation

Operational Mode

In the operational mode, the device services the Internet to serial gateway connections from client applications, and the COM1 port operates in MASTER mode allowing serial to network connections.

The ETC ONE PLUS in operational mode, the PROG LED is off.

Program-Service Mode

In program mode, the COM1 port operates as a service port that allows the user to review or change settings in the device using PAS (see [Using PAS](#) in Chapter 4 for more information).

To put the device into program mode, push PROG button during power up for at least three seconds, until the PROG LED is on.

To leave program mode push PROG button for at least three seconds, until the PROG LED is off.

Service mode is used for local device servicing and upgrading firmware through PAS software.

In program-service mode, the Internet-to-serial gateway is not operational.

See [Upgrading Device Firmware](#) in Chapter 6 for instructions.

Using the ETC ONE PLUS

Slave Network Connection

Serial Network Connections

The ETC ONE PLUS is connected to serial RS-485 slave networks via the COM1 gateway ports.

The COM1 is automatically set to master mode to operate as a gateway port, in normal operation. See [Configuring Serial Ports](#) in Chapter 5 for information on programming serial ports.

The communication protocol to be used for serial networking via the ETC ONE PLUS is defined by the Network TCP service port setting. See [Configuring the Network](#) in Chapter 5 for information on programming the ETC ONE PLUS TCP service port.

Master Network Connections

Serial Network Connections

The ETC ONE PLUS is connected to serial RS-232/422/485 master networks via the COM2 gateway port, using RS-232/422/485 communication module.

The COM1 is automatically set to master mode to operate as a gateway port, in normal operation. See [Configuring Serial Ports](#) in Chapter 5 for information on programming serial ports.

The communication protocol to be used for serial networking via the ETC ONE PLUS is defined by the Network TCP service port setting. See [Configuring the Network](#) in Chapter 5 for information on programming the ETC ONE PLUS TCP service port.

Internet Connections

The ETC ONE PLUS provides a TCP server for master client connections on the standard TCP ports: 502 (Modbus/TCP). The TCP server supports four simultaneous client connections.

The TCP server can be accessed via a local Ethernet network or via Cellular Internet connection using 3G cellular module through COM2 port.

ETC I Communication Setup

To configure the ETC I, press <PROG> button for 3 sec during device power ON, until the <PROG> yellow LED s turned ON. Entering to programming mode enables the user to configure the ETC I setup and/or to update the firmware using the PAS Flash Downloader.

The <PROG> mode state forces the COM1 to be in MODBUS “Slave” mode to enable device configuration with PAS through COM1 (MODBUS RTU).

To exit the programming mode dis-energize the device power and reenergize it back. Make sure the yellow <PROG> Led is turned OFF.

ETC I COM1 setup

The ETC I COM1 port shall be configured as follows using PAS™:

1. Select Communication Setup
2. Select Serial Ports Setup
3. COM1 setup

Port Setup	
Unused	Modbus RTU
Unused	RS-485
Unused	99
Baud Rate	19200
Data Format	8N
Port Direction	N/A
Receive Timeout, ms	N/A
Unused	5
Unused	N/A
Unused	N/A
Unused	N/A

Label	Parameter	Options	Default	Description
Protocol	Communications protocol	MODBUS RTU,	MODBUS RTU	The communications protocol for the port
Interface	Port interface	RS485, RS485, RS232, Modem, GSM/GPRS, RF	RS485	Not changeable;
Device Address	Device address	MODBUS:1-247	1	MODBUS Master device address
Baud rate	Baud rate	2.4-115.2 kbps	19.2 kbps	The port baud rate
Data/Prt	Data format and parity	7E, 8N, 8E	8N	7E data format should not be used with the Modbus RTU protocol
CTS	Clear to send	NA		
RTS	Ready to send	NA		

Label	Parameter	Options	Default	Description
Send Delay	Transmission delay	0-1000 ms	5 ms	The minimum time after the last request character is received to start the transmission.
Chr.Tmout	Inter-character timeout	0-1000 ms	4 ms	The maximum time the line is allowed to idle before closing a connection in the Modbus RTU protocol
Port Mode	Client/Server	Client/Master Server/Slave	Server/slave	To configure the ETC I, it must be set to Server/Slave In normal use to be set to Client/Master
RX Tmout				

ETC I COM2 Ethernet setup

The ETC I COM2 setup shall be configured as follows depending on attached communication module type The ETC I COM2 port shall be configured as follows, using PAS™:

1. Select Communication Setup
2. Select Serial Ports Setup
3. COM2 setup

Port:

Port Setup	
Protocol	Modbus RTU
Interface	Ethernet
Device Address	1
Baud Rate	N/A
Data Format	N/A
CTS	N/A
RTS	N/A
Response Delay, ms	N/A
Character Timeout, ms	N/A
Port Mode	N/A
Receive Timeout, ms	N/A

4. Select Ethernet interface in case of ETHERNET module

Ethernet Connections

To setup your Ethernet connections:

1. Define the network IP parameters via the ETC ONE PLUS Network Setup. If you use the ETC ONE PLUS eXpertPower client connections via the Ethernet network, define a non-zero default gateway address, so the client connections will be directed to the Ethernet.

Network Setup | GPRS Setup | ExpertPower Client Setup | Serial Ports Setup

Current Network Settings	
IP Address	192 . 168 . 0 . 218
Subnet Mask	255 . 255 . 255 . 0
Default Gateway	192 . 168 . 0 . 254
MAC Address	0005F000D141

Network Setup	
Device IP Address	192 . 168 . 0 . 218
Network Subnet Mask	255 . 255 . 255 . 0
Network Default Gateway	192 . 168 . 0 . 254
Use DHCP	NO
Secondary TCP Port	502
Primary DNS IP Address	0 . 0 . 0 . 0
Secondary DNS IP Address	0 . 0 . 0 . 0
Connection Idle Timeout, s	30
Device Address	---

Open Save as... Default Print Send Receive

OK Cancel Apply Help

2. Define the TCP service port number for your application protocol.

Display Label	Parameter	Default
IP Address	Device IP Address	192.168.0.203
Subnet Mask	Network Subnet Mask	255.255.255.0
Def. Gateway	Network Default Gateway	192.168.0.1
TCP Service Port	502 = Modbus/TCP	502

NOTE:

If your ETC ONE PLUS has both the Ethernet and modem network interfaces, the eXpertPower client uses one of these for connections to the eXpertPower™ server. The default Ethernet network gateway address defines which one of the networks is used. If the default gateway address is not defined (i.e., it is set to 0.0.0.0), the ETC ONE PLUS uses the dial-out modem connection via your local Internet provider. If you defined the default network gateway address, any call to the IP address, which is not included in the address space of the both networks, is redirected to the default Ethernet gateway.

ETC I COM2 GPRS setup

The ETC I COM2 setup shall be configured as follows depending on attached communication module type The ETC I COM2 port shall be configured as follows, using PAS™:

1. Select Communication Setup
2. Select Serial Ports Setup
3. COM2 setup

Network Setup | GPRS Setup | ExpertPower Client Setup | Serial Ports Setup

Port: COM2

Port Setup	
Unused	Modbus ASCII
Unused	GSM/GPRS
Unused	99
Baud Rate	N/A
Data Format	N/A
Port Direction	N/A
Receive Timeout, ms	N/A
Unused	N/A
Unused	N/A
Unused	N/A
Unused	N/A

Open Save as... Default Print Send Receive

OK Cancel Apply Help

4. Select GSM/GPRS interface in case of 3G module

Network Setup | GPRS Setup | ExpertPower Client Setup | Serial Ports Setup

Network Settings	
Local IP Address	0 . 0 . 0 . 0
GPRS Setup	
Access Point Name (APN)	publicip.net.it
User name	
Password	
GPRS Mode	Server mode

Open Save as... Default Print Send Receive

OK Cancel Apply Help

Parameter	Default	Description
Access Point Name (APN)	publicip.net.il	The mobile network APN name
User name		Username (if required)
Password		Password (if required)
GPRS mode	Server mode	Server or Client mode

Setting Up eXpertPower Client

The ETC I has an embedded eXpertPower™ client that provides communications with the eXpertPower™ server - the SATEC proprietary Internet services. Connections to the eXpertPower™ server are handled on a periodic basis.

To set up communications with the eXpertPower™ server, the ETC I can be configured as follows, using PAS™:

1. Select Communication Setup
2. Select Expertpower Client Setup

The screenshot shows the 'ExpertPower Client Setup' dialog box with the following configuration:

Parameter	Value
XPW Server IP Address	207.232.60.18
XPW Server Port	5001
XPW Client Enabled	YES
Time to Next Session, min	0
Connection via Network	---
Connection Idle Timeout, min	1

Parameter	Options	Default	Description
XPW Server IP Address		207.232.60.18	The IP address of the eXpertPower server
XPW Server Port	0-65535	5001	The TCP service port of the eXpertPower server
XPW Client Enabled	NO, YES	NO	Enables operations of the eXpertPower client
Time to Next Session, min	1-99999		The time remaining to the next connection session
Idle Timeout, min		1	configurable XPW connection idle timeout via Ethernet connections

Using PAS Software

Supplemental PAS software that came with your ETC ONE PLUS can be used for configuring the ETC ONE PLUS via the Internet or locally (in Programming mode only).

See the “PAS Getting Started Guide” supplied on the installation CD for information on how to install PAS on your PC.

Configuration Database

To communicate with the ETC ONE PLUS from PAS, create a site database for your device. All communication and configuration data for your device will be stored in this database. During configuration, store all setups to the site database so that PAS recognizes device properties regardless of whether the ETC ONE PLUS is online or offline.

To create a new database for your ETC ONE PLUS:

1. Select Configuration from the Tools menu, and then click the Sites button on the right-hand side.

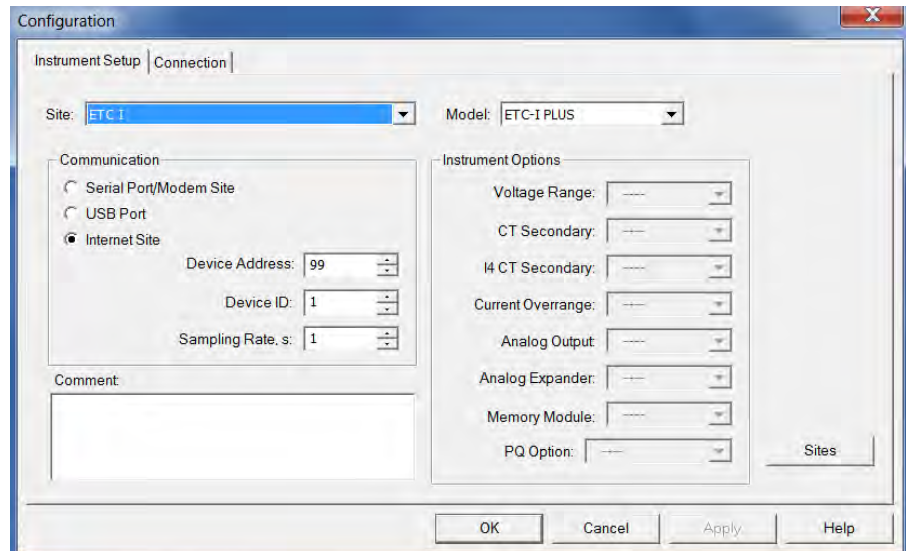

2. From the “Look in” box, select the directory where the new database will be stored. By default, it is the “Sites” directory. Type a site name for your device in the “File name” box, click New, and then click OK.
3. On the Instrument Setup tab, select “ETC ONE PLUS” in the “Model” box.
4. Set the device address to 99 unless you have changed the ETC ONE PLUS default address in your device.
5. If you wish to add any comments for your device, type them into the “Comment” box.

Setting up Communications

Communicating through the Ethernet

To communicate through the Ethernet port:

1. On the Instrument Setup tab, select Internet Site.
2. Click on the Connection tab.
3. Click on the “IP address” and type in the IP address that you defined in Network Setup in your ETC ONE PLUS. The factory set default IP address is 192.168.0.203.

4. In the “Protocol” box, select the communications protocol for the ETC ONE PLUS TCP port. The host port is set automatically as you select the protocol. Select “Modbus RTU” for Modbus/TCP.
5. In the “Wait for answer” box, adjust the time that PAS should wait for a connection before announcing an error and the number of re-tries that PAS should use to receive a response from the device if communications fail.

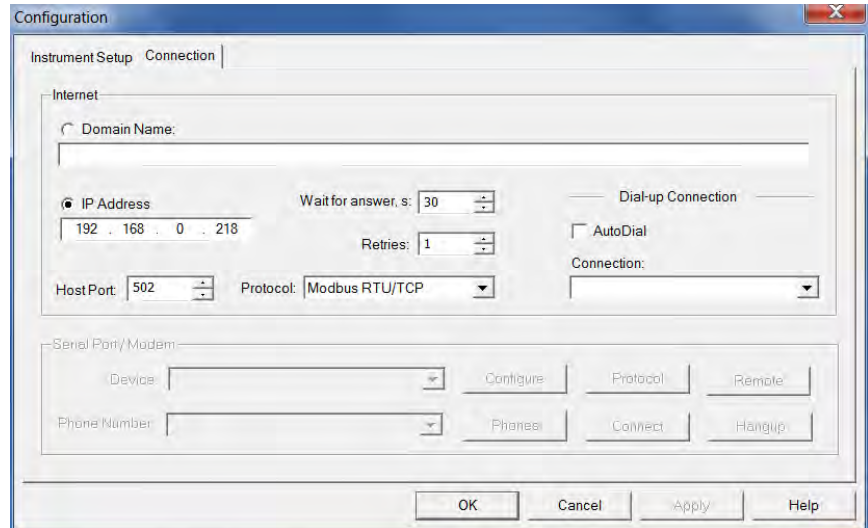

Setting Up the ETC ONE PLUS

PAS allows you to prepare setup data for the ETC ONE PLUS offline without the need to have it connected to your PC.

Select the ETC ONE PLUS site from the list box on the PAS toolbar, and then select the desired setup group from the Meter Setup menu. Click on the tab with the setup you want to create or modify, and then fill in the boxes with the desired configuration data. Click the “Save as...” button to store your new data to the site database.

To save your setup to another site database, select it from the file panel, and then click OK.

To re-use setups from another site, copy them to your present site database. Click Open, select the desired site database, and then click OK. The opened setup is copied to your site database.

You can also copy all setups from one site database into another site's database. Select a device site from the list box on the toolbar from which you want to reproduce setups, and then select “Copy to...” from the Meter Setup menu. Select the site database to which to copy setups, and click OK.

Downloading Setup to the ETC ONE PLUS

You can update each setup in your ETC ONE PLUS one at a time or download all setups together from the site database.

To update a particular setup in your device, check the On-line button on the PAS toolbar, select a device site from the list box on the toolbar, and then select the desired setup group from the Meter Setup menu. Click on the tab of the setup you want to download to the device, and then click Send.

To download all setups to your device at once, check the On-line button on the PAS toolbar, select the device site from the list box on the toolbar, and then select Download Setups from the Meter Setup menu.

Uploading Setup from the ETC ONE PLUS

To upload the setup from the ETC ONE PLUS to the site database, check the On-line button on the PAS toolbar, select the device site from the list box on the toolbar, and then select Upload Setups from the Meter Setup menu.

Authorization

If communications with your ETC ONE PLUS is secured, you are prompted for the password when you send new setup data to the device.

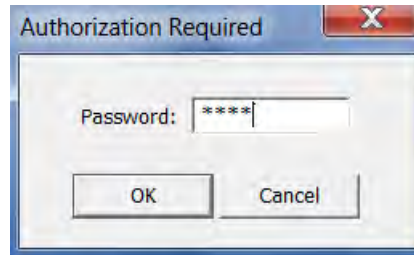

Enter the password and click OK. If your authorization was successful, you are not prompted for the password again until you close the dialog window.

Chapter 4 Setting Up the ETC ONE PLUS

You can configure your ETC ONE PLUS via PAS. See [Connecting to the ETC ONE PLUS](#) for information on establishing a connection with your device using different communication options.

Changing the Password and Security

To change the password, check the On-line button on the PAS toolbar, select Administration from the Monitor menu, and then select Change Password.



To change the password:

1. Type in a new 8-digit password.
2. Repeat the password in the Confirm box.
3. Check the “Enable network protection” box to enable password checking.
4. Click Send.

Changing Time and Date

Select the ETC ONE PLUS site from the list box on the PAS toolbar, check the On-line button, and then select RTC from the Monitor menu.

Click Set to synchronize the ETC ONE PLUS clock with your PC's clock.

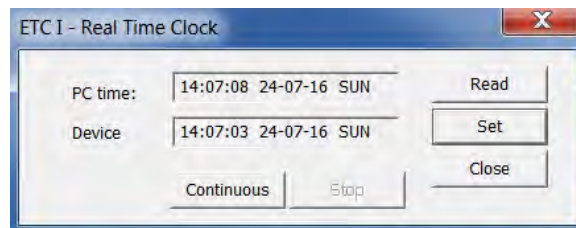

Configuring Local Time Settings

This setup allows you to specify your time zone and daylight savings time options in the ETC ONE PLUS.

Select the ETC ONE PLUS site from the list box on the PAS toolbar, select General Setup from the Meter Setup menu, and then click on the Local Settings tab.

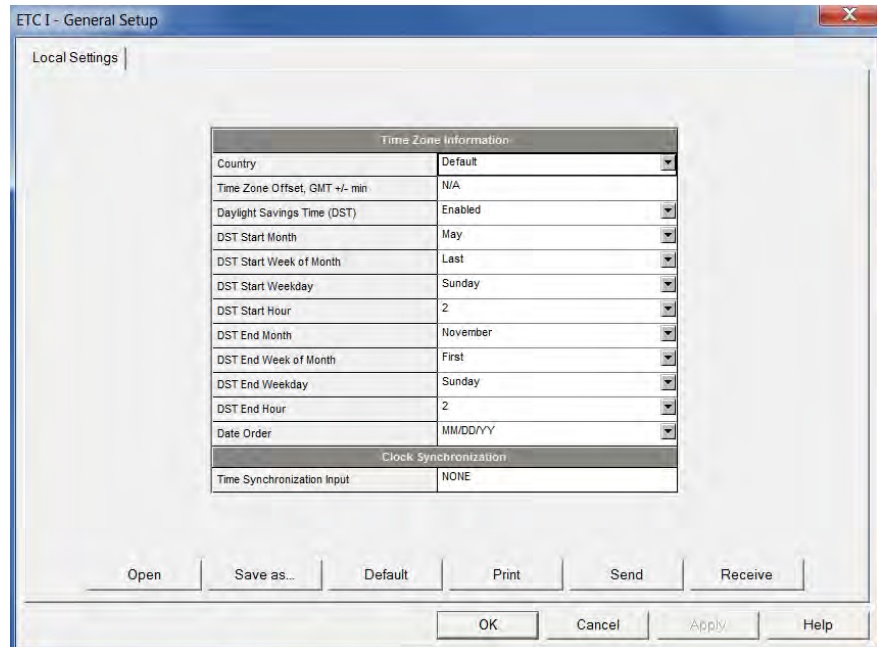

The available setup options are listed in the following table:

Parameter	Options	Default	Description
Time zone offset, min	-720 to 720 min	-300 (Eastern Time)	Local offset in minutes from UTC (Universal Coordinated or Greenwich Mean Time). It is used to produce a local time from the GPS IRIG-B time code.
Daylight savings time	Disabled Enabled	Disabled	When DST is disabled, the RTC operates in standard time only. When enabled, the device automatically updates the time at 2:00 AM at the pre-defined DST switch dates.
DST start month DST start week DST start weekday	Month-week-weekday Week = 1 st , 2 nd , 3 rd , 4 th or Last (last week of the month)	First Sunday in April	The date when Daylight Savings Time begins. The DST switch point is specified by the month, week of the month and weekday. By default, DST starts at 2:00 AM on the first Sunday in April of each year.
DST end month DST end week DST end weekday	Month-week-weekday Week = 1 st , 2 nd , 3 rd , 4 th or Last (last week of the month)	Last Sunday in October	The date when Daylight Savings Time ends. The DST switch point is specified by the month, week of the month and weekday. By default, DST ends at 2:00 AM on the last Sunday in October of each year.

The daylight savings time option is disabled in the ETC ONE PLUS by default. The default daylight savings time change points are pre-set for the U.S.A.

When daylight savings time is enabled, the meter automatically adjusts the device clock at 02.00 AM when daylight savings time begins/ends. If the daylight savings time option is disabled, you must manually adjust the device clock for daylight savings time.

Configuring Device Routing Table

The ETC I pass-through gateway routing table is predefined in the firmware as follows:

MODBUS Slave devices to be polled shall have fixed address 1-31, the ETC I MODBUS Master address shall be 32 or higher (99).

Chapter 5 Upgrading Device Firmware

This chapter describes the procedure of upgrading firmware in the ETC ONE PLUS through the COM1 RS-485 port using PAS™.

When you put your device into program mode, its COM1 port operates as MODBUS Slave port at 19200 baud by default. Downloading firmware at a slow baud rate may be very time-consuming. It is recommended to use the maximum available speed of 115200 baud for downloading firmware.

Returning to Normal mode operation the ETC I COM1 port will operate back as MODBUS Master port at the predefined baud.

Your meter has upgradeable firmware. If you need to upgrade your device, download a new firmware file to the meter through PAS.

Firmware can be downloaded via the MODBUS RTU or MODBUS/TCP protocol through any communication port.

To download a new firmware file to your device:

1. Ensure that the communication port you are connected through to the meter operates in Modbus mode.
2. If you are connected to the meter through a serial interface, it is recommended to set the port baud rate to 115,200 bps. See [Setting Up Serial Communication Ports](#) on how to remotely change the protocol and baud rate in your meter.
3. Ensure that the **On-line** button on the PAS toolbar is checked, and then select **Flash Downloader** from the **Monitor menu** and confirm downloading.
4. Point to the firmware upgrade file for your meter, click Open, and then confirm upgrading the meter.

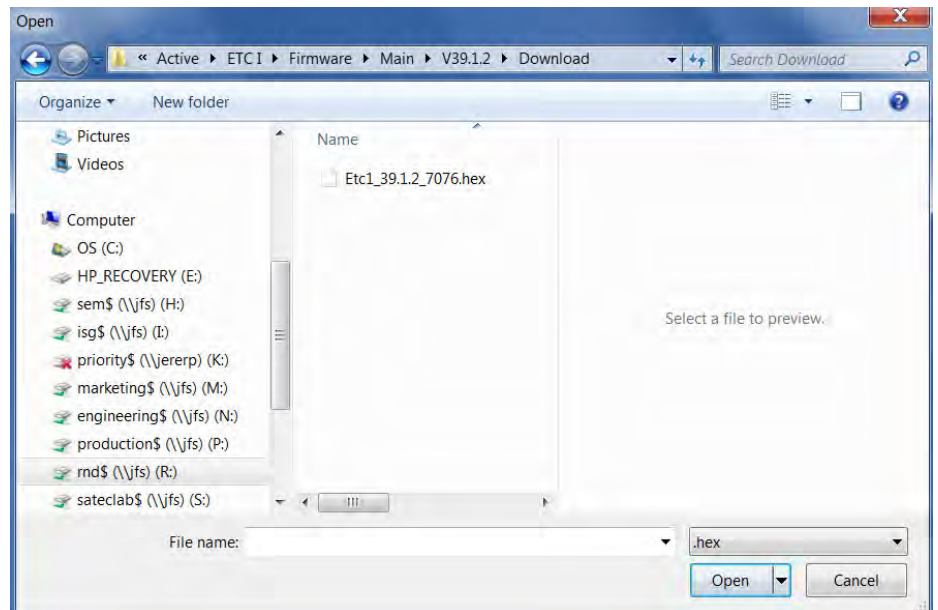

5. You are asked for the password regardless of the password protection setting in your meter. Type the meter password, and click OK. If you did not change the password in the meter, enter the default password 0.

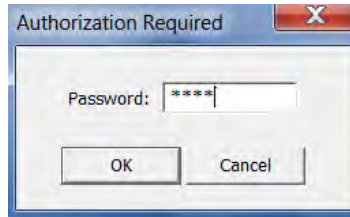

6. Wait until PAS completes upgrading your device. It takes about 3-4 minutes at 115,200 bps to download the file to the meter.

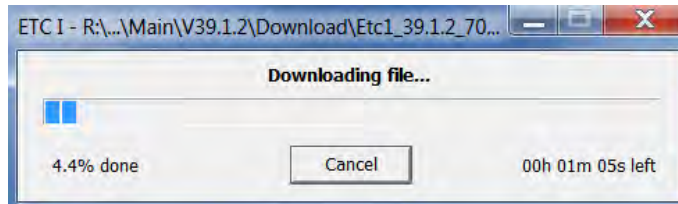

7. After upgrading firmware is completed, the meter restarts, so communications can be temporarily lost. You may need to wait a short duration until PAS restores a connection with your device.

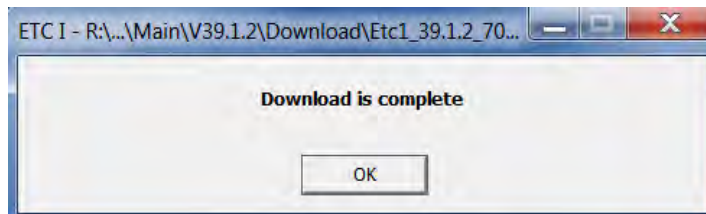

Appendix Technical Specifications

Environmental Conditions

Operational ambient temperature limit range: -25°C to +60°C

Specified ambient temperature range: -20°C to +60°C

Long-term damp heat withstand according to IEC 68-2-3 <95% (non-condensing), +40 °C

Transport and storage temperature range: -30°C to +85 °C

IEC 60068-2-6, AS 60068-2-6 [18]: Vibration

Frequency range: 10Hz to 150Hz

Vibration time (each axis): 75 min

Sweep rate: 1 oct/min

Max Vibration level: 10 m/s² (1g), f > 60Hz

IEC 60068-2-27, AS 60068-2-27 [19]: Shock

Shock level: 30 g

Time duration: 18 ms

Shape: Half sine

Number of shocks: 18

Construction

Case enclosure: Reinforced Polycarbonate

Packaging case: Carton and Stratocell® (Polyethylene Foam) brackets

Labels: Polyester film (UL94-V0)

Power Supply

AC/DC Power Supply

Rated input: 40-300VAC 50/60Hz, 40-300VDC, Burden 5VA

Frequency range operation 25-400 Hz

Isolation:

Input to ground: 4000V AC

Wire size: up to 12 AWG (up to 3.5 mm²)

Torque terminal screw: 0.5-0.7 Nm.

DC Power Supply 12/24VDC

Rated input: 9-36VDC

Isolation:

Input to ground: 2500V AC

Wire size: up to 12 AWG (up to 3.5 mm²)

Torque terminal screw: 0.5-0.7 Nm.

Communication Ports

COM1 (standard)

RS-485 optically isolated port

Isolation: 3000V AC 1 min

Baud rate: up to 115.2 kbps.

Protocols: Modbus RTU, Master/Slave

Torque terminal screw: 0.5-0.7 Nm.

Wire size: 14 AWG (up to 1.5 mm²)

COM2

Ethernet Port (Optional module)

Transformer-isolated 10/100BaseT Ethernet port

Protocols: MODBUS/TCP (Port 502)

Number of simultaneous connections: 4

Connector type: RJ45 modular.

3G Cellular Port (Optional module)

2G/3G - GSM Network

Protocols: MODBUS/TCP (Port 502)

Number of simultaneous connections: 4

Antenna Connector type: SMA.

RS-232/422-485 Port (Optional module)

RS-232 or RS-422/485 optically isolated port

Isolation: 3000V AC 1 min

Baud rate: up to 115.2 kbps.

Protocols: MODBUS RTU, Slave

Connector type: removable, 5 pins for RS-422/485 and DB9 for RS-232.

Torque terminal screw: 0.5-0.7 Nm.

Real-time Clock

Standard Meter Clock

Crystal Clock Accuracy: typical error 13.15 sec per month (2.63 minutes per year) @ 25°C (±5ppm)

Typical clock retention time: 15 months