



shadowspec
umbrellas with distinction



SHADOWSPEC UNITY™

The Evolution of Shade



**Fabric
Warranty***
BEST-IN-CLASS



**Frame
Warranty***
BEST-IN-CLASS



Trusted for
over 25 years



Hand built in
New Zealand



Marine
Grade

SHADOWSPEC UNITY™ Multi Canopy Rotating Cantilever Umbrella

Patented & Trademarked Technology



SHADOWLIFT™
Gas-assisted deployment for an easy lift.



SHADOWGLIDE™
Engineered to open or close in 5 seconds.



SHADOWHUB™
LED light technology built-in and App controlled.



SHADOWLOCK™
Integrated security and wind-protection.

Canopy



Stock Colours

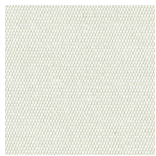

Oyster

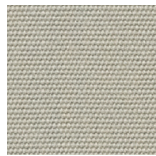

Alpine Stone

Special-Order Colours**



Natural



Storm

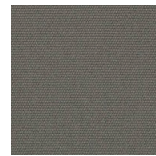

Charcoal



Slate

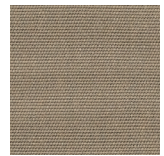

Taupe

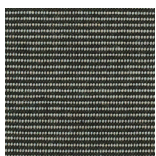

Charcoal Tweed

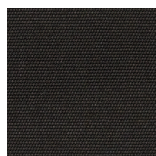

Black

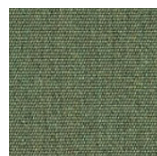

Fern

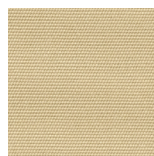

Linen

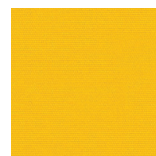

Sunflower Yellow

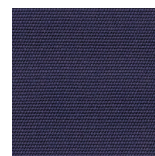

Captain Navy

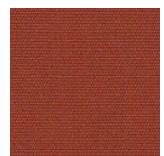

Terracotta

RECASENS
BCN 1886



**Special-Order Colours are non-stock and will incur an additional lead time and surcharge. Full Sunbrella range is available as a custom colour option.



Marine Grade



Solution-dyed, High Colour Fastness



UV and Fade Resistant



UPF 80 UV Protection



Eco-friendly Production



Breathable Weave



Mould and Mildew Resistant



Oil and Stain Repellent



Easy Clean



Water Resistant



Chlorine Resistant



Tear Resistant

Size & Configuration

SQUARE UNO

2.5m | 8' or 3.0m | 10'

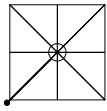

SQUARE DUO

5.0m | 16' or 6.0m | 20'

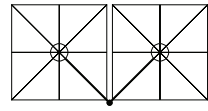

SQUARE DUO

5.0m | 16' or 6.0m | 20'

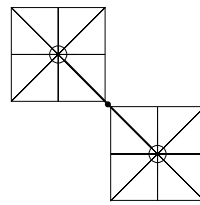

SQUARE TRIO

5.0m | 16' or 6.0m | 20'

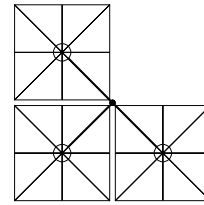

SQUARE QUATTRO

5.0m | 16' or 6.0m | 20'

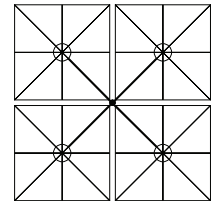

OCTAGON UNO

3.5m | 11' or 4.0m | 13'

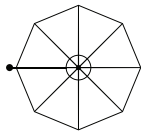

OCTAGON DUO

7.0m | 22' or 8.0m | 26'

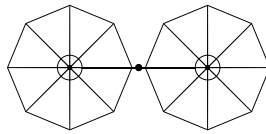

Features



MARINE GRADE

No-rust, 316 Stainless Steel Spigot.

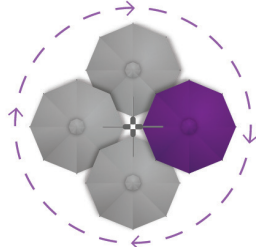

FOLLOW THE SUN

Enjoy the 360° rotation for all-day-shade.

Optional Accessories



LED LIGHT CONTROL

Power your light with the optional Smart Battery or Hardwire Kit.



PROTECTION COVER

Optional care and protection for your umbrella.

Mounting Options

SURFACE PLATE

For deck, patio and concrete mounting. (316 Stainless Steel)



IN-GROUND ANCHOR

For mounting with a concrete footing.



WALL MOUNT BRACKET

For when ground mounting isn't possible. (316 Stainless Steel)



FREE-STANDING BASE + ALUMINIUM BASE COVER*

For complete customised manoeuvrability.



Optional Castor Wheels.

N.b. Concrete Pavers are required for ballast (not supplied).

Umbrella Dimensions

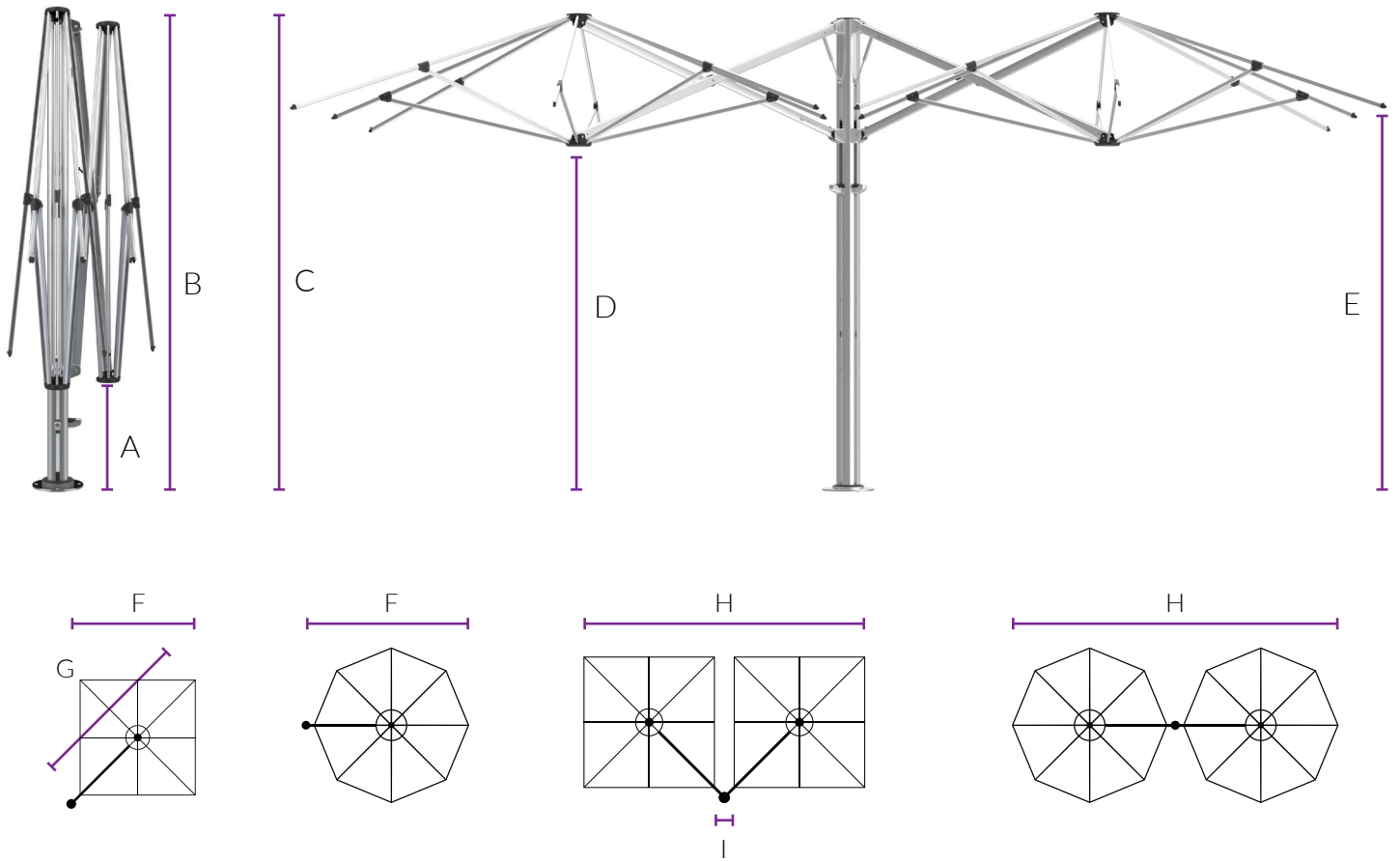

Diagram Legend	2.5m	8'	3.0m	10'	3.5m	11'	4.0m	13'
A Ground to central frame hub when closed*	860mm	2'10"	620mm	2'1"	1079mm	3'7"	866mm	2'10"
B Total height to top of canopy*	2900mm	9'6"	2824mm	9'3"	2975mm	9'9"	2899mm	9'6"
C Height of umbrella to top of mast cap*	2908mm	9'6"	2908mm	9'6"	2908mm	9'7"	2908mm	9'6"
D Ground to central frame hub when open*	2130mm	7'0"	2054mm	6'9"	2205mm	7'3"	2128mm	7'0"
E Ground to lower outer edge of canopy*	2222mm	7'3"	2219mm	7'3"	2237mm	7'4"	2172mm	7'2"
F Centre of Spigot to outside edge of canopy	2646mm	8'8"	2973mm	9'10"	3447mm	11'4"	3923mm	12'10"
G Diagonal from centre of mast to corner	3742mm	12'3"	4205mm	13'10"	N/A	N/A	N/A	N/A
H Duo/Quattro umbrella width edge to edge	5292mm	17'4"	5946mm	19'6"	6894mm	22'7"	7846mm	25'9"
I Gutter space between canopies	160mm	6"	160mm	6"	N/A	N/A	N/A	N/A

*Free-Standing Base installations will add 165mm | 6" to the height and surface plates will add 12mm | ½" to the height. Adding Free-Standing Base wheels will add a further 45-80mm | 2-3" to the height. All sizings and conversions are approximate and subject to change without notice. Refer to specsheets for exact, up-to-date measurements.



Australia
0438 733 860
www.umbrello.com.au



shadow spec
umbrellas with distinction