

chill index

100 Years 1920—2020

September 2022



1920 - 2020 - 100 Years Young

www.orford.com.au

Orford Chill Index

Refrigerators—General

Orford FMB20	Page 5
Orford FMB Black	Page 6
Orford FMB30	Page 7
Orford EB20 EcoChill™ Range	Page 8
Orford EB30 EcoChill™ Range	Page 10
Orford EB30 Storage Fridge	Page 11
Orford EB30 Pass Thru Rear Loading	Page 12
Orford EB36 EcoChill™ Range	Page 13
Orford EB36 Pass Thru Rear Loading	Page 14
Orford EB45 EcoChill™ Range	Page 15
Orford EB45 Pass Thru Rear Loading	Page 16
Orford EB EcoChill™ Energy Figures	Page 17
Halo HR350-B Slim Impulse	Page 18
Halo TF85 Impulse counter top	Page 19

Freezer— General

Orford VB36L Freezer	Page 21
Orford FML Freezer Series	Page 22

Refrigerator—Specialties

Orford Flower Fridges 4U	Page 27
Orford Wine Fridges	Page 31
Orford Chocolate Fridges	Page 36
Orford Cake & Bakery Displays	Page 40

Freezer—Specialties

Orford FML Ice Merchandiser	Page 43
-----------------------------	-------------------------

Underbench / Underbars

Orford BB Backbar Range	Page 47
Halo KUR Undercounter Refrigerator	Page 51
Halo KUF Undercounter Freezer	Page 52
Halo KURF Undercounter Combos	Page 53

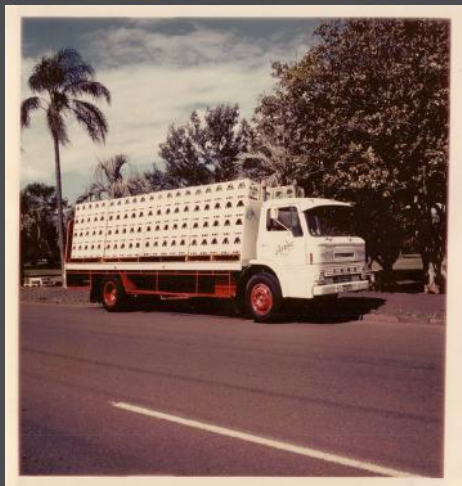

chill index

www.orford.com.au

www.halorefrigeration.com.au

1300 ORFORD

1300 673 673

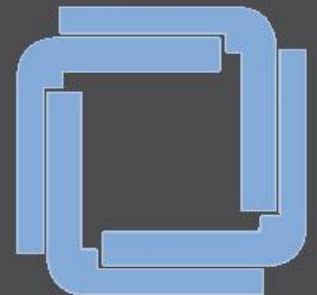

Orford Chill Index

Halo Food Services

- Halo KRF Fridge/Freezer [Page 57](#)
- Halo KR Refrigerator [Page 61](#)
- Halo KF Freezer [Page 62](#)
- Halo KHR Salad Table [Page 63](#)
- Orford Beverage Dispenser s [Page 66](#)

Manitowoc Ice Machines

- Manitowoc UG Series [Page 70](#)
- Manitowoc Neo U Series
- Manitowoc Indigo Series
- Manitowoc Flakers
- Manitowoc Nugget Machines
- Manitowoc M Series
- Manitowoc Accessories
- Manitowoc Commercial Warranty

Orford Finance

[Page 86](#)

Orford Sign Shop

Terms & Conditions

MEPS / Cabinets & Climate Class

Contact Us

Prices are excluding GST, Freight and Insurance

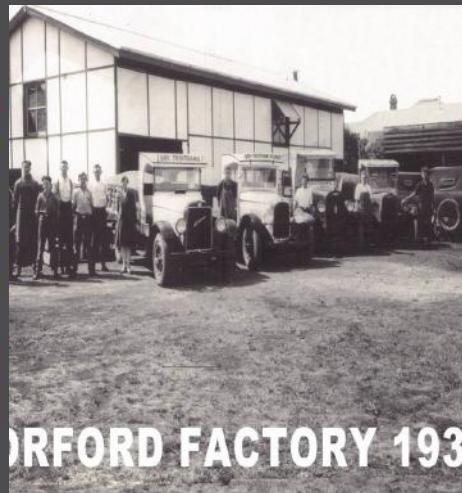

chill index

www.orford.com.au

www.halorefrigeration.com.au

1300 ORFORD

1300 673 673

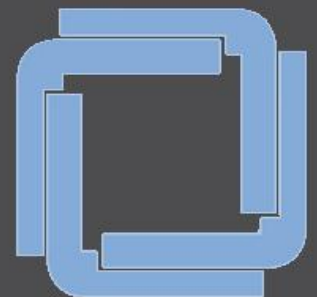

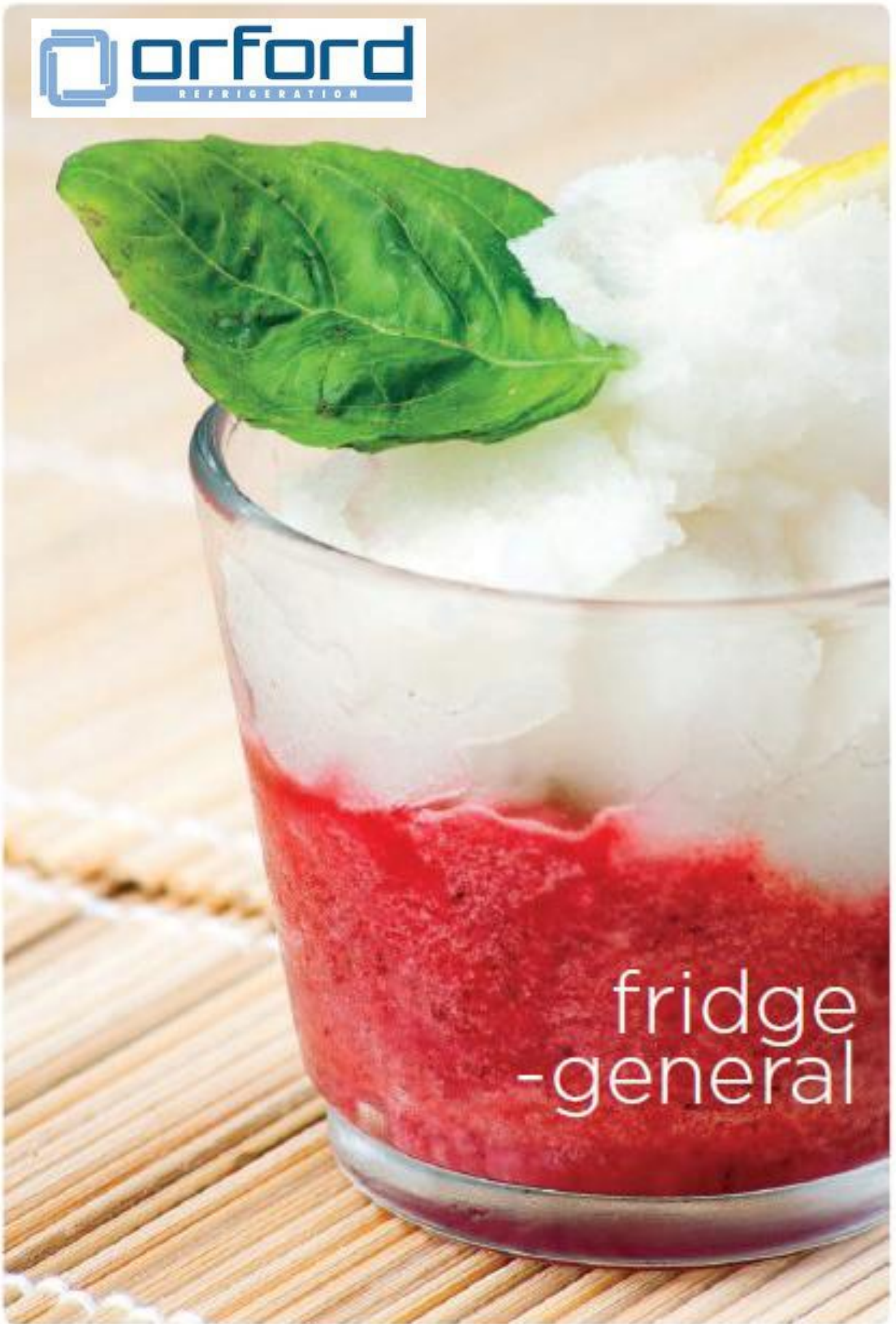

fridge
-general

Do you have an ABN?
Contact us for a trade discount!

FMB20—B	Vertical Display Refrigerator
Capacity	557 Litres (Gross)
Dimensions	740W x 791D x 2010H
Weight	165Kg
Operating Temp	0° - 5° C.
Ambient Temp Range	0° - 40° C.
Power Point	230 - 240v 50Hz. (Standard GPO)
Controller	Digital—Carel controller
Shelves	4 Height Adjustable Heavy Duty PVC Coated
Shelf Adjustment	Shelf size : 610w x 450d (mm) 12mm Increments
Door	1 x Self Closing, Double Glazed Safety Glass, Single Heat reflective Low E, Argon filled, Right Hand hinged. (Left hand hinge available)
Footings	Heavy Duty Castors 75mm high, Lockable Front
Compressor	Danfoss
Interior Light	LED (on/off switch included) T8 1200mm tube
Refrigerant	R134A
Insulation	50mm Polyurethane, CFC, HCFC, HFC Free
Climate Class	Class 5
MEPS	Compliant (High Efficiency)
Condenser Filter	Rear mounted

FMB20-Sn	Vertical Display Refrigerator with Illuminated Advertising Sign
Construction	Powder Coated galvanized steel Int / Ext White
Capacity	557Litres (Gross)
Dimensions	740W x 791D x 2200H
Weight	165Kg
Operating Temp	0° - 5° C.
Ambient Temp	0° - 40° C.
Range	
Power Point	230 - 240v 50Hz. (Standard GPO)
Controller	Digital Carel Controller
Shelves	4 Height Adjustable Heavy Duty PVC Coated
Shelf Adjustment	12mm Increments
Door	1 x Self Closing, Double Glazed Safety Glass, Single Heat reflective Low E, Argon filled, Right Hand hinged. (Door handle on left)
Footings	Heavy Duty Castors 75mm high, Lockable Front
Compressor	Danfoss
Interior Light	LED (on/off switch included) T8 1200mm tube
Refrigerant	R134A
Insulation	50mm Polyurethane, CFC, HCFC, HFC Free
Climate Class	Class 5
MEPS	Compliant (High Efficiency)
Condenser Filter	Rear mounted
Illuminated Advertising Sign	200mm High, Top Mounted.
Sign Illumination	LED

Orford FMB20—B

RRP : \$2600 + GST



Energy consumed : 5.425 kWh/24hr

Orford FMB20Sn—B

RRP : \$2745 + GST



Energy consumed : 5.589 kWh/24hr

Carel digital controller standard

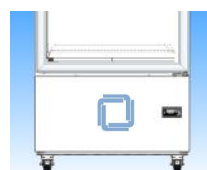

View this cabinet on display at our 39 Dunhill Crescent, Morningside, Queensland showroom. Phone or text 0418 700 006 for visit times.

Do you have an ABN?
Contact us for a trade discount!

FMB20-Sn-B	Vertical Display Refrigerator with Illuminated Advertising Sign
Construction	Powder Coated galvanized steel Int / Ext Black
Capacity	557Litres (Gross)
Dimensions	740W x 791D x 2200H
Weight	165Kg
Operating Temp	0° - 5° C.
Ambient Temp Range	0° - 40° C.
Power Point	230 - 240v 50Hz. (Standard GPO)
Digital Controller	Digital Carel Controller
Shelves	4 Height Adjustable Heavy Duty PVC Coated
Shelf Adjustment	12mm Increments
Door	1 x Self Closing, Double Glazed Safety Glass, Argon filled Single Heat reflective Low E, Right Hand hinged.
Footings	Heavy Duty Castors, Lockable Front
Compressor	Danfoss
Interior Light	LED (on/off switch included) T8 1200mm tube
Refrigerant	R134A
Insulation	50mm Polyurethane, CFC, HCFC, HFC Free
Climate Class	Class 5
MEPS	Compliant (High Efficiency)
Condenser Filter	Rear mounted
Illuminated Advertis-	200mm High, Top Mounted.
Sign Illumination	LED

Orford FMB20Sn-B—Black
RRP : \$2745 + GST



Energy consumed : 5.425

FMB30-Sn	Vertical Display Refrigerator with Illuminated Advertising Sign
Construction	Powder Coated galvanized steel Int/ Ext Black
Capacity	889 Litres (Gross)
Dimensions	1130W x 791D x 2200H
Weight	210Kg
Operating Temp	0° - 5° C.
Ambient Temp Range	0° - 40° C.
Power Point	230 - 240v 50Hz. (Standard GPO)
Digital Controller	Digital Carel Controller
Shelves	8 Height Adjustable Heavy Duty PVC Coated
Shelf Adjustment	12mm Increments
Door	1 x Self Closing, Double Glazed Safety Glass, Argon filled Single Heat reflective Low E, Right Hand hinged.
Footings	Heavy Duty Castors, Lockable Front
Compressor	Danfoss
Interior Light	LED (on/off switch included) T8 1200mm tube
Refrigerant	R134A
Insulation	50mm Polyurethane, CFC, HCFC, HFC Free
Climate Class	Class 5
MEPS	Compliant (High Efficiency)
Condenser Filter	Rear mounted
Illuminated Advertis-	200mm High, Top Mounted.
Sign Illumination	LED

Orford FMB30Sn-B-Black
RRP : \$3408 + GST



Energy consumed : 5.589 kWh/24hr

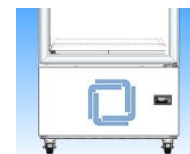

New with
Carel digital
controller

Do you have an ABN?
Contact us for a trade discount!

FMB30—B	Vertical Display Refrigerator
Construction	Powder Coated galvanized steel Interior /
Capacity	889 Litres (Gross)
Dimensions	1130W x 791D x 2010H
Weight	210Kg
Operating Temp	0° - 5° C.
Ambient Temp Range	0° - 40° C.
Power Point	230 - 240v 50Hz. (Standard GPO)
Controller	Digital Carel Controller
Shelves	8 Height Adjustable Heavy Duty PVC Coated
Shelf Adjustment	12mm Increments
Door	1 x Self Closing, Double Glazed Safety Glass, Single Heat reflective Low E, Argon filled,
Footings	Heavy Duty Castors, Lockable Front
Compressor	Danfoss
Interior Light	LED (on/off switch included) T8 1200mm tube
Refrigerant	R134A
Insulation	50mm Polyurethane, CFC, HCFC, HFC Free
Climate Class	Class 5
MEPS	Compliant (High Efficiency)
Condenser Filter	Rear mounted

Orford FMB30—B
RRP : \$3265 + GST



Energy consumed : 7.59 kWh/24hr

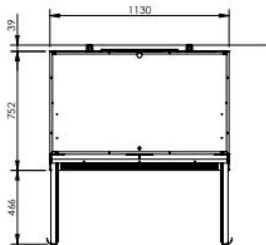

B Models onwards
come standard with
Carel digital controller

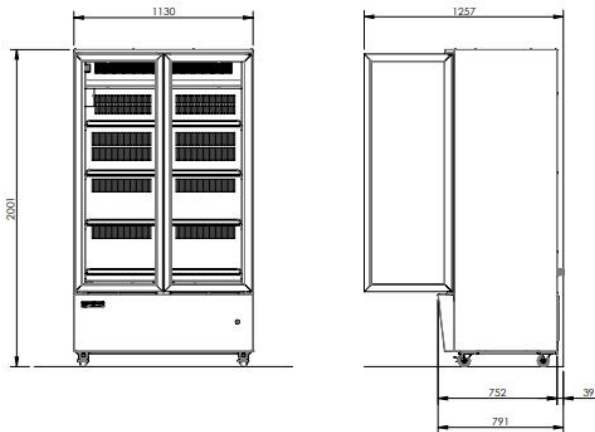

Do you have an ABN?
Contact us for a trade discount!

FMB30-Sn—B	Vertical Display Refrigerator with Illuminated Advertising Sign
Construction	Powder Coated galvanized steel Int/ Ext White
Capacity	889 Litres (Gross)
Dimensions	1130W x 791D x 2200H
Weight	210Kg
Operating Temp	0° - 5° C.
Ambient Temp Range	0° - 40° C.
Power Point	230 - 240v 50Hz. (Standard GPO)
Controller	Digital Carel Controller
Shelves	8 Height Adjustable Heavy Duty PVC Coated
Shelf Adjustment	12mm Increments
Door	1 x Self Closing, Double Glazed Safety Glass, Single Heat reflective Low E, Argon filled, Right Hand hinged.
Footings	Heavy Duty Castors, Lockable Front
Compressor	Danfoss
Interior Light	LED (on/off switch included) T8 1200 mm tube
Refrigerant	R134A
Insulation	50mm Polyurethane, CFC, HCFC, HFC Free
Climate Class	Class 5
MEPS	Compliant (High Efficiency)
Condenser Filter	Rear mounted
Illuminated Advertising Sign	200mm High, Top Mounted.
Sign Illumination	LED

Orford FMB30Sn—B

RRP : \$3408 + GST



Energy consumed : 8 kWh/24hr

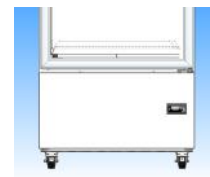

B models onwards come standard with Carel digital controller

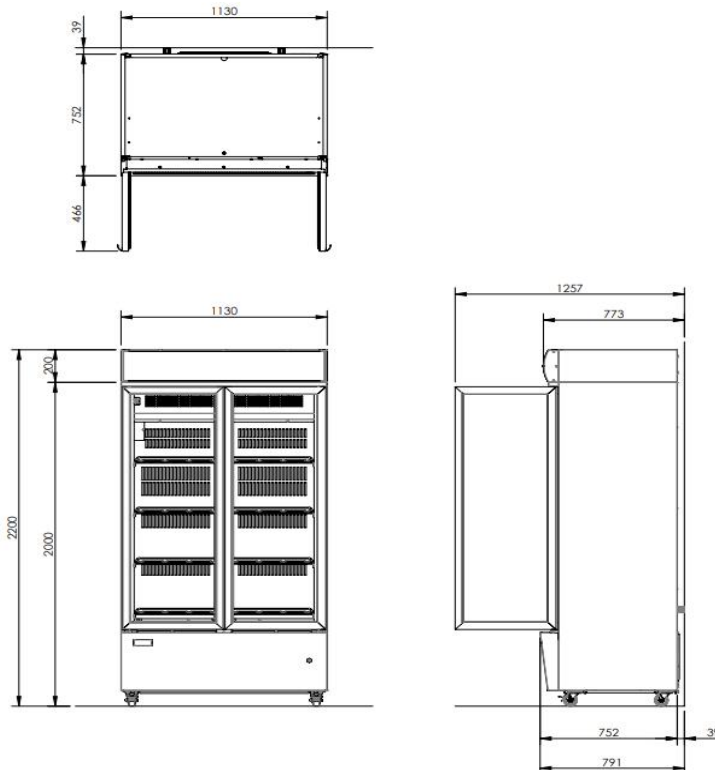

Do you have an ABN?
Contact us for a trade discount!

EB20R-Sn Specifications	Vertical Display Refrigerator with Illuminated Advertising Sign
Construction	Powder Coated galvanized steel Interior / Exterior White
Capacity	595 Litres (Gross)
Dimensions	756W x 762D x 2220H
Weight	155Kg
Operating Temp	0° - 5° C.
Ambient Temp Range	0° - 40° C.
Power Point	220 - 240v 50Hz. (Standard GPO)
Input Current	2.8 Amps
Thermometer	Digital
Shelves	4 Height Adjustable Heavy Duty PVC Coated
Shelves	1 Fixed Stainless Steel Base Shelves
Shelf Adjustment	12mm Increments
Refrigerated Shelf Area	1.42 m ²
Condensate Disposal	Automatic by energy efficient, No Cost, Hot Gas 1 x Self Closing, Double Glazed Safety Glass, Double Heat reflective Low E, Warm edge, R/H
Door	Right hand hinged with door handle on left Heavy Duty Castors, Lockable Front
Footings	LED, Automatic and manual control T8 1350mm tube
Interior Light	R134a
Refrigerant	Solid Core
Drier	50mm Polyurethane, CFC, HCFC, HFC Free
Insulation	3M1, 4M1, 5M1
Cabinet Classes	Compliant (High Efficiency)
MEPS	3.43 kWh/24h
* Energy Consumption	Easy front access
Condenser Filter	200mm High, Top Mounted
Illuminated Advertising Sign	LED, Automatic and manual control
Sign Illumination	

RRP : \$3800 + GST
Orford EB20R-Sn-A

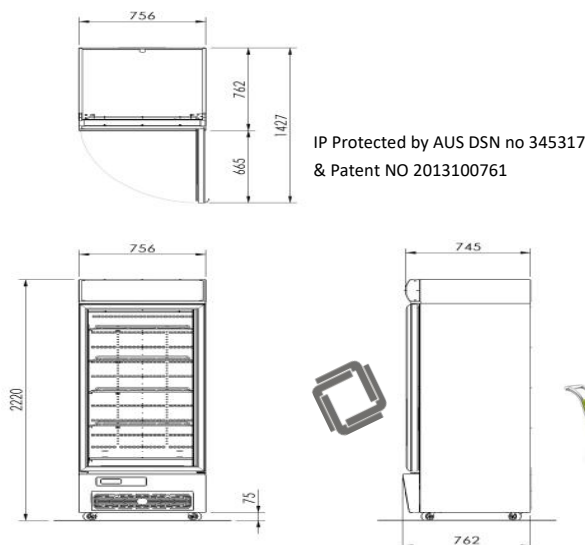

The Orford Group EB Model	Energy Consumption @3M1 kWh/24hr
EB20R-A	3.17
EB20R-SN-A with illuminated sign	3.43



Do you have an ABN?
Contact us for a trade discount!

EB20R-BLO-A Specifications	Vertical Storage Refrigerator
Construction	Stainless Steel
Capacity	595 Litres (Gross)
Dimensions	756W x 762D x 2220H
Weight	165Kg
Operating Temp	0° - 5° C.
Ambient Temp Range	0° - 40° C.
Power Point	220 - 240v 50Hz. (Standard GPO)
Input Current	2.8 Amps
Thermometer	Digital
Shelves	4 Height Adjustable Heavy Duty PVC Coated
Shelves	1 Fixed Stainless Steel Base Shelves
Shelf Adjustment	12mm Increments
Refrigerated Shelf Area	1.42 m ²
Condensate Disposal	Automatic by energy efficient, No Cost, Hot Gas
Door	1 x Self Closing, Block doors
Footings	Heavy Duty Castors, Lockable Front
Interior Light	LED, Automatic and manual control T8 1350mm
Refrigerant	R134a
Cabinet Classes	3M1, 4M1, 5M1
MEPS	Compliant (High Efficiency)
* Energy Consumption	3.43 kWh/24h
Condenser Filter	Easy front access
Sign Illumination	LED, Automatic and manual control

RRP : \$4415 + GST
Orford EB20R-Blo-A

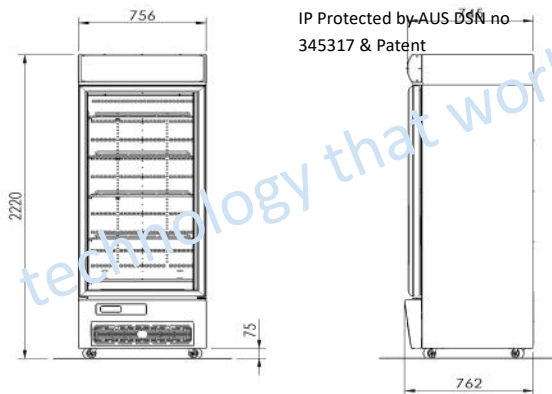
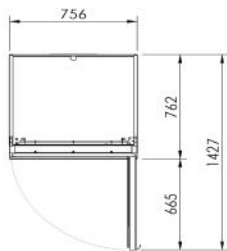

The Orford Group	Energy Consumption
EB Model	@3M1 kWh/24hr
EB20R-BLO-A	3.17

technology that works



Do you have an ABN?
Contact us for a trade discount!

EB30R-Sn Specifications	Vertical Display Refrigerator with Illuminated Advertising Sign
Construction	Powder Coated galvanized steel Interior /Exterior White
Capacity	895 Litres (Gross)
Dimensions	1094W x 762D x 2220H
Weight	210Kg
Operating Temp	0° - 5° C.
Ambient Temp Range	0° - 40° C.
Power Point	220 - 240v 50Hz. (Standard GPO)
Input Current	2.8 Amps
Thermometer	Digital
Shelves	8 Height Adjustable Heavy Duty PVC Coated
Shelves	2 Fixed Stainless Steel Base Shelves
Shelf Adjustment	12mm Increments
Refrigerated Shelf Area	2.17 m ²
Condensate Disposal	Automatic by energy efficient, No Cost, Hot Gas
Door	2 x Self Closing, Double Glazed Safety Glass, Double Heat reflective Low E, Warm edge
Footings	Heavy Duty Castors, Lockable Front
Interior Light	LED, Automatic and manual control T8 1350mm
Refrigerant	R134a
Cabinet Classes	3M1, 4M1, 5M1
MEPS	Compliant (High Efficiency)
* Energy Consumption	4.24 kWh/24h
Condenser Filter	Easy front access
Illuminated Advertising	200mm High, Top Mounted
Sign Illumination	LED, Automatic and manual control

RRP : \$4324 + GST
Orford EB30R-Sn-A

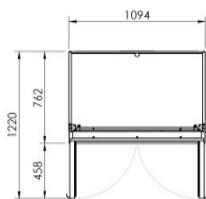

IP Protected by AUS DSN no 345317
& Patent NO 2013100761

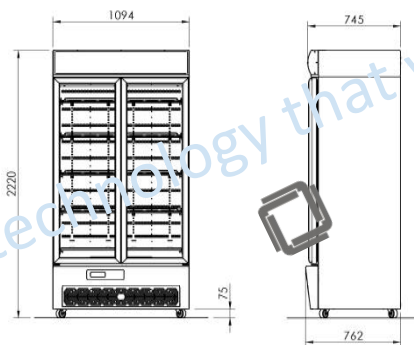

The Orford Group EB Model	Energy Consumption @3M1 kWh/24hr
EB30R-A	3.78
EB30R-SN-A with illuminated sign	4.24

technology that works



Do you have an ABN?
Contact us for a trade discount!

EB30R-BLO-A Specifications	Vertical Storage Refrigerator
Construction	Stainless Steel
Capacity	895 Litres (Gross)
Dimensions	1094W x 762D x 2020H
Weight	210Kg
Operating Temp	0° - 5° C.
Ambient Temp Range	0° - 40° C.
Power Point	220 - 240v 50Hz. (Standard GPO)
Input Current	2.8 Amps
Thermometer	Digital
Shelves	8 Height Adjustable Heavy Duty PVC Coated
Shelves	2 Fixed Stainless Steel Base Shelves
Shelf Adjustment	12mm Increments
Refrigerated Shelf Area	2.17 m ²
Condensate Disposal	Automatic by energy efficient, No Cost, Hot Gas
Door	2 x Self Closing, Block doors
Footings	Heavy Duty Castors, Lockable Front
Interior Light	LED, Automatic and manual control T8 1350mm
Refrigerant	R134a
Cabinet Classes	3M1, 4M1, 5M1
MEPS	Compliant (High Efficiency)
* Energy Consumption	4.24 kWh/24h
Condenser Filter	Easy front access
Sign Illumination	LED, Automatic and manual control

RRP : \$4800 + GST
Orford EB30R-Blo-A

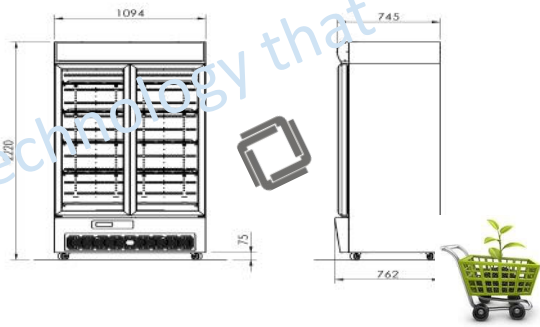
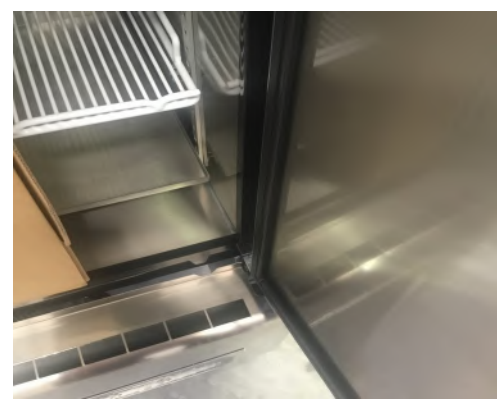

The Orford Group	Energy Consumption
EB Model	@3M1 kWh/24hr
EB30R-BLO-A	3.78



Do you have an ABN?
Contact us for a trade discount!

EB30R-Sn-PT Specifications	Rear Loading Display Refrigerator with Illuminated Advertising Sign
Construction	Powder Coated galvanized steel
Capacity	895 Litres (Gross)
Dimensions	1094W x 762D x 2220H
Weight	210Kg
Operating Temp	0° - 5° C.
Ambient Temp Range	0° - 40° C.
Power Point	220 - 240v 50Hz. (Standard GPO)
Input Current	2.8 Amps
Thermometer	Digital
Shelves	8 Height Adjustable Heavy Duty PVC Coated
Shelves	2 Fixed Stainless Steel Base Shelves
Shelf Adjustment	12mm Increments
Door + Rear doors	2 x Self Closing, Double Glazed Safety Glass, Double Heat reflective Low E, Warm edge
Footings	2 x Self closing powdercoated doors Heavy Duty Castors, Lockable Front
Interior Light	LED, Automatic and manual control. T8
Refrigerant	R134a
Drier	Solid Core
Insulation	50mm Polyurethane, CFC, HCFC, HFC Free
Cabinet Classes	3M1, 4M1, 5M1
MEPS	Compliant (High Efficiency)
* Energy Consumption	4.74 kWh/24h
Condenser Filter	Easy front access
Illuminated Advertising	200mm High, Top Mounted
Sign Illumination	LED, Automatic and manual control

RRP : \$4622 + GST
Orford EB30R-Sn-A-PT

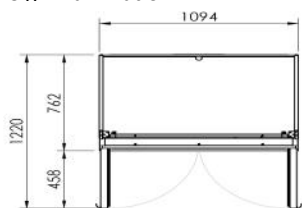
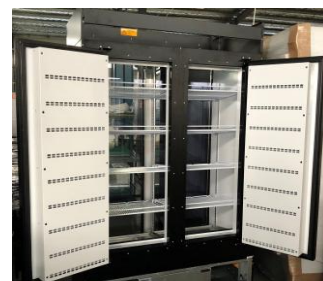

IP Protected by AUS DSN no 345317
& Patent NO 2013100761

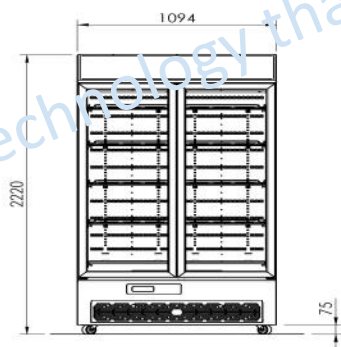

technology that works



Do you have an ABN?
Contact us for a trade discount!

EB36R-Sn Specifications	Vertical Display Refrigerator with Illuminated Advertising Sign
Construction	Powder Coated galvanized steel
Capacity	1071 Litres (Gross)
Dimensions	1286W x 762D x 2220H
Weight	221Kg
Operating Temp	0° - 5° C.
Ambient Temp Range	0° - 40° C.
Power Point	220 - 240v 50Hz. (Standard GPO)
Input Current	2.9 Amps
Thermometer	Digital
Shelves	8 Height Adjustable Heavy Duty PVC Coated
Shelves	2 Fixed Stainless Steel Base Shelves
Shelf Adjustment	12mm Increments
Door	2 x Self Closing, Double Glazed Safety Glass, Double Heat reflective Low E, Warm edge
Footings	Heavy Duty Castors, Lockable Front
Interior Light	LED, Automatic and manual control T8
Refrigerant	R134a
Drier	Solid Core
Insulation	50mm Polyurethane, CFC, HCFC, HFC Free
Cabinet Classes	3M1, 4M1, 5M1
MEPS	Compliant (High Efficiency)
* Energy Consumption	4.74 kWh/24h
Condenser Filter	Easy front access
Illuminated Advertising	200mm High, Top Mounted
Sign Illumination	LED, Automatic and manual control

RRP : \$4786 + GST
Orford EB36R-Sn-A

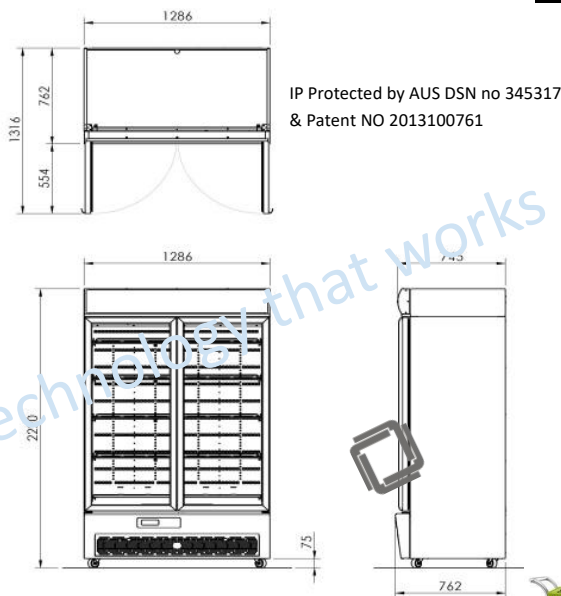

The Orford Group EB Model	Energy Consumption @3M1 kWh/24hr
EB36R-A	4.28
EB36R-SN-A with illuminated sign	4.74



Do you have an ABN?
Contact us for a trade discount!

EB36R-Sn-PT Specifications	Rear Loading Display Refrigerator with Illuminated Advertising Sign
Construction	Powder Coated galvanized steel
Capacity	1071 Litres (Gross)
Dimensions	1286W x 762D x 2220H
Weight	221Kg
Operating Temp	0° - 5° C.
Ambient Temp Range	0° - 40° C.
Power Point	220 - 240v 50Hz. (Standard GPO)
Input Current	2.9 Amps
Thermometer	Digital
Shelves	8 Height Adjustable Heavy Duty PVC Coated
Shelves	2 Fixed Stainless Steel Base Shelves
Shelf Adjustment	12mm Increments
Door + Rear doors	2 x Self Closing, Double Glazed Safety Glass, Double Heat reflective Low E, Warm edge
Footings	2 x Self closing powdercoated doors Heavy Duty Castors, Lockable Front
Interior Light	LED, Automatic and manual control. T8
Refrigerant	R134a
Drier	Solid Core
Insulation	50mm Polyurethane, CFC, HCFC, HFC Free
Cabinet Classes	3M1, 4M1, 5M1
MEPS	Compliant (High Efficiency)
* Energy Consumption	4.74 kWh/24h
Condenser Filter	Easy front access
Illuminated Advertising	200mm High, Top Mounted
Sign Illumination	LED, Automatic and manual control

RRP : \$5193 + GST
Orford EB36R-Sn-A-PT

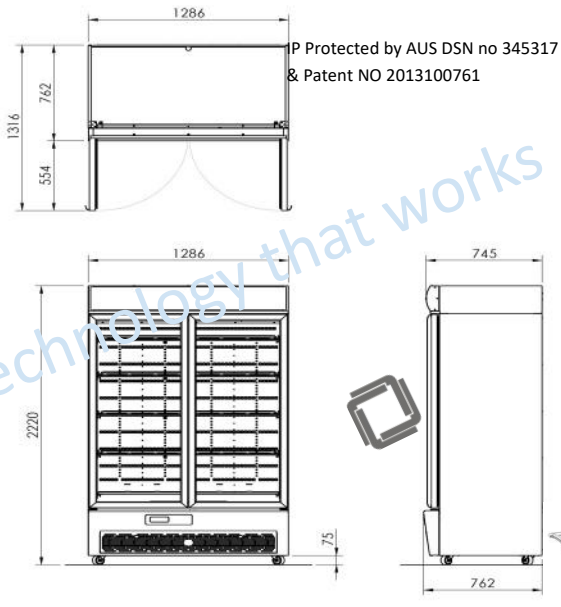
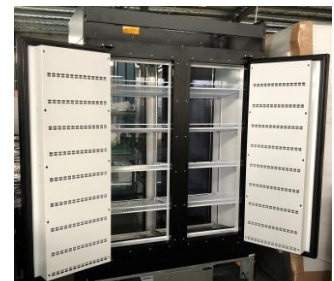

Do you have an ABN?
Contact us for a trade discount!

EB45R-Sn	Vertical Display Refrigerator with Illuminated Advertising Sign
Specifications	
Construction	Powder Coated galvanized steel
Capacity	1384 Litres (Gross)
Dimensions	1640W x 762D x 2220H
Weight	265 Kg
Operating Temp	0° - 5° C.
Ambient Temp Range	0° - 40° C.
Power Point	220 - 240v 50Hz. (Standard GPO)
Input Current	3.2 Amps
Thermometer	Digital
Shelves	12 Height Adjustable Heavy Duty PVC Coated
Shelves	3 Fixed Stainless Steel Base Shelves
Shelf Adjustment	12mm Increments
Refrigerated Shelf Area	3.38 m ²
Condensate Disposal	Automatic by energy efficient, No Cost, Hot Gas
Door	3 x Self Closing, Double Glazed Safety Glass,
Footings	Double Heat reflective Low E, Warm edge Heavy Duty Castors, Lockable Front
Interior Light	LED, Automatic and manual control . T8
Refrigerant	R134a
Cabinet Classes	3M1, 4M1, 5M1
MEPS	Compliant (High Efficiency)
* Energy Consumption	6.03 kWh/24h
Condenser Filter	Easy front access
Illuminated Advertising	200mm High, Top Mounted
Sign Illumination	LED, Automatic and manual control

RRP : \$5907 + GST
Orford EB45R-Sn-A

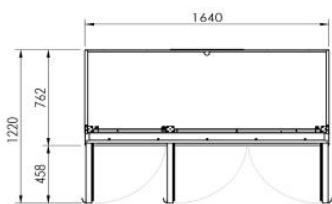

IP Protected by AUS DSN no
345317 & Patent NO 2013100761

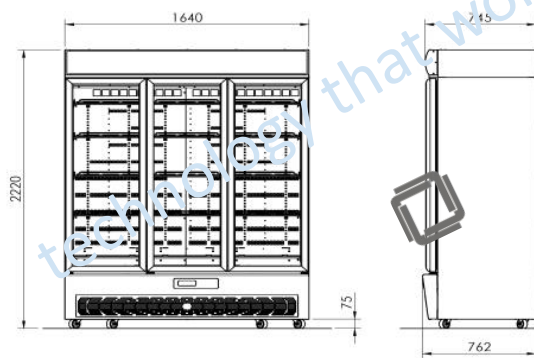

The Orford Group	Energy Consumption
EB Model	@3M1 kWh/24hr
EB45R-A	5.45
EB45R-SN-A with illuminated sign	6.03



Do you have an ABN?
Contact us for a trade discount!

EB45R-Sn-PT Specifications	Rear Loading Display Refrigerator with Illuminated Advertising Sign
Construction	Powder Coated galvanized steel
Capacity	1384 Litres (Gross)
Dimensions	1640W x 762D x 2220H
Weight	265 Kg
Operating Temp	0° - 5° C.
Ambient Temp Range	0° - 40° C.
Power Point	220 - 240v 50Hz. (Standard GPO)
Input Current	3.2 Amps
Thermometer	Digital
Shelves	12 Height Adjustable Heavy Duty PVC Coated
Shelves	3 Fixed Stainless Steel Base Shelves
Shelf Adjustment	12mm Increments
Refrigerated Shelf Area	3.38 m ²
Condensate Disposal	Automatic by energy efficient, No Cost, Hot Gas 3 x Self Closing, Double Glazed Safety Glass,
Door	Double Heat reflective Low E, Warm edge
Footings	3 x Self closing powder coated rear doors Heavy Duty Castors, Lockable Front
Interior Light	LED, Automatic and manual control. T8
Refrigerant	R134a
Cabinet Classes	3M1, 4M1, 5M1
MEPS	Compliant (High Efficiency)
* Energy Consumption	6.03 kWh/24h
Condenser Filter	Easy front access
Illuminated Advertising	200mm High, Top Mounted
Sign Illumination	LED, Automatic and manual control

RRP : \$6480 + GST
Orford EB45R-Sn-PT

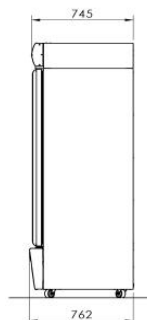
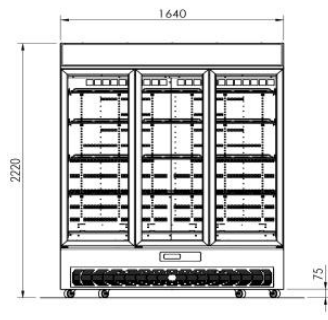
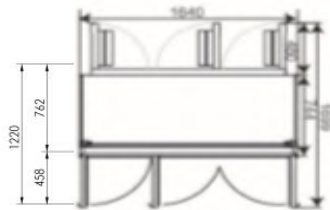

IP Protected by AUS DSN no 345317
& Patent NO 2013100761



Do you have an ABN?
Contact us for a trade discount!

Orford EB Range Energy Figures

The Orford Group Patented EB Model	Energy Consumption @ 3M1 kWh/24hr	Running Cost based on power at .28c per kW
EB20R-A	3.17	3.17 @ .28c = .89c per day = \$324.84 per annum
EB20R-Sn-A (with sign box)	3.43	3.43 @ .28c = .96c per day = \$350.40 per annum
EB30R-A	3.78	3.78 @ 28c = \$1.06c per day = \$386.90 per annum
EB30R-Sn-A (with sign box)	4.24	4.24 @ 28c = \$1.19 per day = \$434.35 per annum
EB36R-A	4.28	4.28 @ 28c = \$1.20 per day = \$428.00 per annum
EB36R-Sn-A (with sign box)	4.74	4.74 @ 28c = \$1.33 per day = \$485.45 per annum
EB45R-A	5.45	5.45 @ 28c = \$1.53 per day = \$558.45 per annum
EB45R-Sn-A (with sign box)	6.03	6.03 @ 28c = \$1.69 per day = \$616.85 per annum



1920 - 2020 - 100 Years Young



technology that works

IP Protected by AUS DSN no 345317 & Patent NO 2013100761





Halo HR350 Slim

Do you have an ABN?
Contact us for a trade discount!



Halo HR350-B Slim RRP \$ 1650 + GST

The Halo HR 350—B Slim offers eye catching appeal to Increase impulse sales. A versatile and energy efficient solution for your cooling requirements.

Quiet enough for Commercial or Domestic application

www.orford.com.au for specification sheet

Elegant Slim-lined styled, display refrigerator for storage and impulse merchandising

White in colour with Cool Grey Trim

- Strong well constructed body
- LED light, offering, long life, brilliant merchandising, stunning product visibility and energy savings
- Dixell controller with dust cover protects small fingers
- Low Global Warming Refrigerant R600a
- Lockable self closing doors
- Independent light switches for internal light and signbox

View this cabinet on display at our 39 Dunhill Crescent, Morningside, Queensland showroom. Phone or text 0418 700 006 for visit times.

Specifications	Slim Impulse HR350-B Display Fridge
Brand	Halo
Model	HR350-B
Maximum Ambient Temp	35°C (Perishables in maximum 25°C air conditioning)
Temp Range	+1°C to +10°C
Capacity /L	339 Litres
Refrigerant	R600a
External Dims in mm	640 w x 670 d x 1940 h
Internal Dims in mm	530 w x 430 d x 1205 h
Thermometer	Dixell Electronic Controller with dust cover
Shelves	4 adjustable shelves with rear product stop and front ticket stripping
Door	1 swing door hinged on the right with lock
Footings	4 x castors
Interior Light	Single LED light
Weight	75kg
Light switches	Separate light box switch and cabinet light switch
Power Point	10Amp GPO
Input power	1.84 kW/24h





Halo TF85 Impulse

Do you have an ABN?
Contact us for a trade discount!



Halo® TF-85 Countertop Fridge RRP \$900 + GST

The Halo TF-85 counter top offers eye catching appeal to increase impulse sales. A versatile and energy efficient solution for your cooling requirements.

www.orford.com.au

Certificate of Suitability No : AZ 69023706

Features

- ◆ Elegant Slim-line styled, Reach-in Display Fridge for Storage and Merchandising
- ◆ Strong well-constructed body
- ◆ LED Light, offering, Long life, brilliant merchandising, stunning product visibility and energy savings.
- ◆ Energy efficient, self-closing glass door
- ◆ Plug and Use—power requirements Standard 10 Amp. Power point
- ◆ Low Global Warming Refrigerant R600a adding a new dimension to environmental efficiency.
- ◆ Easy grip integrated handle

View this cabinet on display at our 39 Dunhill Crescent, Morningside, Queensland showroom. Phone or text 0418 700 006 for visit times.

Halo TF-85 Specifications

Countertop Impulse Refrigerator

Construction	Powder Coated galvanized steel Interior / Exterior White
Capacity	85 Ltr 505 w x 590 d x 780 H External
Dimensions	410 w x 395 d x 625 H Internal Decal size : 455w x 715h. Glass area 426h (mm)
Weight	35 kg
Operating Temp	0° - 10° C.
Ambient Temperature	32° C.
Power Point	220 - 240v 50Hz. (Standard GPO)
Thermometer	Mechanical thermometer control
Shelves	3 Height Adjustable Heavy Duty PVC Coated
Condensate Disposal	Automatic by energy efficient, No Cost, Hot Gas
Door	1 x Safety Glass, With door locks
Footings	2 adjustable feet at front and 2 rollers at the back
Interior Light	LED (on/off switch included)
Refrigerant	R600a
Insulation	Polyurethane, CFC, HCFC, HFC Free
Power Supply	1 x 10 AMP





freezer
-general

Do you have an ABN?
Contact us for a trade discount!

VB36L-Sn-A Specifications	Vertical Display Ice Freezer with Illuminated Advertising Sign
Construction	Powder Coated galvanized steel Interior /Exterior White
Capacity	1071 Litres (Gross)
Dimensions	1286W x 866 D (+82 overhang = 952mm total) x 2215H (mm)
Weight	250 Kg (net)
Operating Temp	-19° to -23° C.
Ambient Temp Range	0° - 40° C.
Power Point	220 - 240v 50Hz. (15AMP power outlet)
Input Current	6.3 Amps
Thermometer	Digital
Shelves	8 Height Adjustable Heavy Duty PVC Coated
Shelves	2 Fixed Stainless Steel Base Shelves
Shelf Adjustment	12mm Increments
Refrigerated Shelf Area	2.62 m ²
Condensate Disposal	Automatic by energy efficient, No Cost, Hot Gas
Full Handled Door	2 x Self Closing, Triple Glazed Safety Glass, Argon filled with Double Heat reflective Low E, Warm edge with removable
Footings	Heavy Duty Castors, Lockable Front
Interior Light	LED, Automatic and manual control
Refrigerant	R404a
Drier	Solid Core
Insulation	60mm Polyurethane, CFC, HCFC, HFC Free
Cabinet Classes	3L1, 4L2, 5L3 up to 40 degree Celsius ambient
MEPS	Compliant (High Efficiency)
* Energy Consumption	20.73 kWh/24h/m2
Condenser Filter	Easy front access
Illuminated Advertising Sign	205mm High, Top Mounted
Sign Illumination	LED, Automatic (motion sensor control) and manual control
Temperature Alarms	High and low temperature alarms
HACCP Function	Alarm system
Defrost	Energy Efficient Hot Gas
Sign Illumination	LED, Automatic and manual control

FREEZERS

Orford VB36L-Sn-A Freezer

RRP : \$8885 + GST

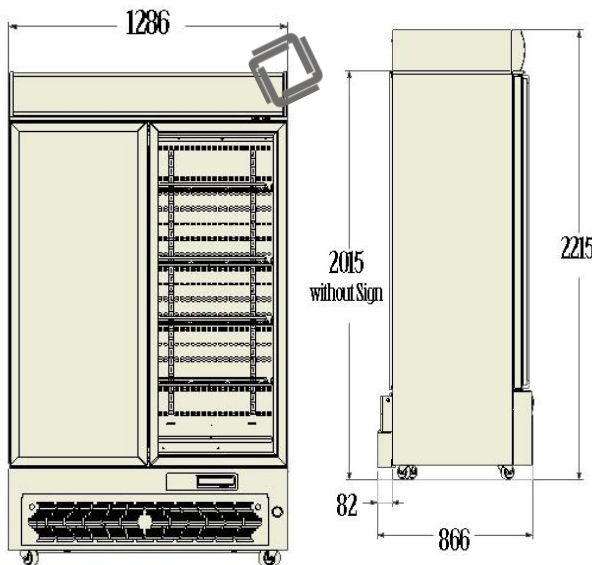

The Orford Group VB Freezer Model	Energy Consumption @3L1 kWh/24hr
VB36L-Sn-A	20.73

Introducing the 2016 Orford Bottom Mount VB36L-Sn-A Freezer with a removable package.

Matches the Orford EB Range

100% designed by the Orford Engineering Team

Patent Protected in Australia & New Zealand



The Orford FML Freezer Series

Present your frozen food beautifully to your customer with the

Orford FML Freezer Series Available in 1 door, 2 door and 3 door

The Orford FML50 is available in R290 Refrigerant.



What is R290 Refrigerant? R290 is natural, non-toxic and free of ozone-depleting properties with a low GWP Global Warming Potential.



The Future is Now



View this cabinet on display at our 39 Dunhill Crescent, Morningside, Queensland showroom. Phone or text 0418 700 006 for visit times.



Model	Temp	Doors	Net Volume	Shelves	Dimensions	RRP Price
FML-20	-18 to -22	1	560	5	750 w x 760 d x 2039 h	\$4275 + GST
FML-30	-18 to -22	2	960	10	1253 w x 760 d x 2039 h	\$5567 + GST
FML-50	-18 to -22	3	1480	15	1880 w x 760 d x 2039 h	\$6920 + GST

Do you have an ABN?
Contact us for a trade discount!

Orford
REFRIGERATION



The Orford FML Freezer Series



Do you have an ABN?
Contact us for a trade discount!

Orford Freezer FML20	Vertical Display Freezer
Specifications	
Construction	Powder Coated galvanized steel Interior /Exterior White standard (black optional, check
FML-20	1 DOOR FREEZER
Capacity	560 Litres (gross)
Dimensions	750 w x 760 D x 2039 H (B models post 2022 stock) with new higher ezyglide castors)
Weight	150kg (net)
Temp	-18c—-22c
Doors	1 x Self Closing, Triple Glazed Safety Glass, Argon filled with Double Heat reflective Low E,. Hinged to the LEFT. With door handle on the RIGHT
Ambient temp	32c degrees
Weight	166 Kg (net)
Power Point	220—240v (1 x 10 AMP powerpoint)
* Energy Consumption	12.7 kWh/24h/m2
Common Specifications	FML20 / FML30 / FML50
Compressor	Danfoss
Thermometer	Digital Elitech Controller
Shelves per door	5 Height Adjustable Heavy Duty PVC Coated
Shelf Adjustment	12mm Increments
Condensate Disposal	Automatic by energy efficient, No Cost, Hot Gas
Footings	Heavy Duty 2.5mm Ezy Roll Castors, Lockable Front
Interior Light	LED light with light switch
Refrigerant	R290 Natural Refrigerant (B models onwards)
Drier	Solid Core to suit
Insulation	60mm Polyurethane, CFC, HCFC, HFC Free
Cabinet Classes	
Condenser Filter	Easy front access
Drip Tray Evaporation	Hot Gas
Method	
Kick Panel	Easy unclip and remove system
Defrost	Energy Efficient Hot Gas
Compliance	MEPS, EMC,

Orford FML-20-B Freezer

RRP \$4275 + GST

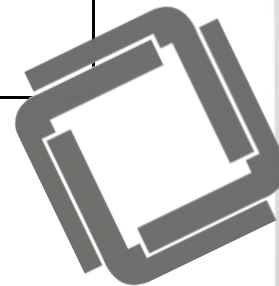

The Orford FML Freezer Series



Do you have an ABN?
Contact us for a trade discount!

<i>Orford Freezer FML30</i>	2 Door Vertical Display Freezer	
Specifications		
Construction	Powder Coated galvanized steel	Interior / Exterior White
FML-30	2 DOOR FREEZER	
Capacity	930 Litres (gross)	
Dimensions	1253 w x 760 D x 2039 H (mm)	
Weight	240 kg (net)	
Doors	2 x Self Closing, Triple Glazed Safety Glass, Argon filled with Double Heat reflective Low E,	
Temp	-18—-22c degrees	
Ambient Temperature	32 degrees	
Power Point	1 x 15 AMP plug	
* Energy Consumption	22.4 kWh/24h/m2	
Common Specifications	FML20 / FML30 / FML50	
Compressor	Danfoss	
Thermometer	Digital Elitech Controller	
Shelves per door	5 Height Adjustable Heavy Duty PVC Coated	
Shelf Adjustment	12mm Increments	
Condensate Disposal	Automatic by energy efficient, No Cost, Hot Gas	
Footings	Heavy Duty 2.5mm Ezy Roll Castors, Lockable Front	
Interior Light	LED light	
Refrigerant	R290 Natural Refrigerant (B models onwards)	
Drier	Solid Core	
Insulation	60mm Polyurethane, CFC, HCFC, HFC Free	
Cabinet Classes		
Condenser Filter	Easy front access	
Drip Tray Evaporation	Hot Gas	
Method		
Kick Panel	Easy unclip and remove system	
Defrost	Energy Efficient Hot Gas	
Compliance	MEPS, EMC,	

Orford FML-30-B Freezer

RRP \$5567 + GST



The Orford FML Freezer Series



Orford FML50-B Freezer

With R290 Refrigerant

RRP \$6920 + GST



Orford Freezer FML-50	3 Door Vertical Display Freezer
Specifications	
Construction	Powder Coated galvanized steel Interior /Exterior White
FML-50-B	3 DOOR FREEZER
Capacity	1450 Litres (gross)
Dimensions	1880 w x 760 D x 2039 H (mm)
Weight	305 kg (net)
Doors	3 x Self Closing, Triple Glazed Safety Glass, Argon filled with Double Heat reflective Low E,
* Energy Consumption	34.3 kWh/24h/m2
Operating Temp	-18° to -22° C.
Ambient Temp Range	32 degrees
Power Point	220 - 240v 50Hz. (1 x 15 AMP power outlet)
Compressor	Danfoss
Digital Controller	Digital Carel Controller
Shelves per door	5 Height Adjustable Heavy Duty PVC Coated
Shelf Adjustment	12mm Increments
Condensate Disposal	Automatic by energy efficient, No Cost, Hot Gas
Footings	Heavy Duty 2.5mm Ezy Roll Castors, Lockable Front
Interior Light	LED light
Refrigerant	R290 Natural Refrigerant (B models onwards)
Drier	Solid Core
Insulation	60mm Polyurethane, CFC, HCFC, HFC Free
Cabinet Classes	3L1
Condenser Filter	Easy front access
Drip Tray Evaporation Method	Hot Gas
Kick Panel	Easy unclip and remove system
Defrost	Energy Efficient Hot Gas
Compliance	MEPS, EMC,
Orford Website Link	www.orford.com.au
Specification Sheet	FML50-B spec sheet

Do you have an ABN?
Contact us for a trade discount!



specialities



Do you have an ABN?
Contact us for a trade discount!

EB30R-Sn-Flower Specifications	Vertical Flower Refrigerator with Illuminated Advertising Sign
Flower Cabinet	Designed to extend the shelf life of fresh flowers
Capacity	895 Litres (Gross)
Dimensions	1094W x 762D x 2220H
Weight	210Kg
Florist Benefits	Temperature Management for flowers
Colours	Ebony Black, and Snow White
Power Point	220 - 240v 50Hz. (Standard GPO)
Input Current	2.9 Amps
Thermometer	Digital
Shelves	8 Height Adjustable Heavy Duty PVC Coated
Shelves	2 Fixed Stainless Steel Base Shelves
Shelf Adjustment	12mm Increments
Door	2 x Self Closing, Double Glazed Safety Glass, Double Heat reflective Low E, Warm edge
Footings	Heavy Duty Castors, Lockable Front
Interior Light	LED, Automatic and manual control
Refrigerant	R134a
Cabinet Classes	3M1, 4M1, 5M1
MEPS	Compliant (High Efficiency)
* Energy Consumption	4.24 kWh/24h
Condenser Filter	Easy front access
Illuminated Advertis-	200mm High, Top Mounted
Sign Illumination	LED, Automatic and manual control

RRP : \$4324 + GST
Orford EB30R-Sn-A-Flower



Daily running costs based on power costs of .28c per kW

- \$1.20 per day with sign box off
- \$1.33 per day with sign box on

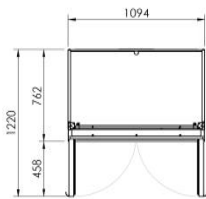

IP Protected by AUS DSN no 345317 & Patent NO 2013100761

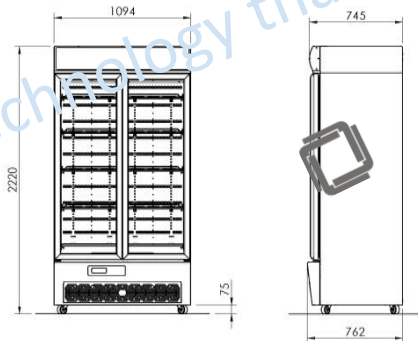

Flower Fridges 4 U

For more information on the Orford Group flower Range including features & benefits refer to

www.flowerfridges4u.com.au



Do you have an ABN?
Contact us for a trade discount!

EB36R-Sn-Flower Specifications	Vertical Flower Refrigerator with Illuminated Advertising Sign
Flower Cabinet	Designed to extend the shelf life of fresh flowers
Capacity	1071 Litres (Gross)
Dimensions	1286W x 762D x 2220H
Weight	221Kg
Florist Benefits	Temperature Management for flowers
Colours	Ebony Black, and Snow White
Power Point	220 - 240v 50Hz. (Standard GPO)
Input Current	2.9 Amps
Thermometer	Digital
Shelves	8 Height Adjustable Heavy Duty PVC Coated
Shelves	2 Fixed Stainless Steel Base Shelves
Shelf Adjustment	12mm Increments
Door	2 x Self Closing, Double Glazed Safety Glass, Double Heat reflective Low E, Warm edge
Footings	Heavy Duty Castors, Lockable Front
Interior Light	LED, Automatic and manual control
Refrigerant	R134a
Cabinet Classes	3M1, 4M1, 5M1
MEPS	Compliant (High Efficiency)
* Energy Consumption	4.74 kWh/24h
Condenser Filter	Easy front access
Illuminated Advertis-	200mm High, Top Mounted
Sign Illumination	LED, Automatic and manual control

RRP : \$4786 + GST
Orford EB36R-Sn-A-Flower



Daily running costs based on power costs of .28c per kW

- \$1.20 per day with sign box off
- \$1.33 per day with sign box on

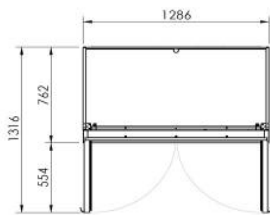

IP Protected by AUS DSN no 345317 & Patent NO 2013100761

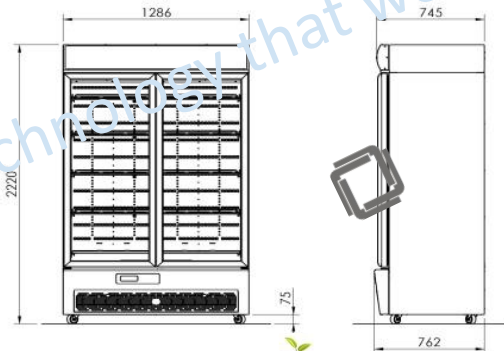

Flower Fridges 4 U

For more information on the Orford Group flower Range including features & benefits refer to

www.flowerfridges4u.com.au



Do you have an ABN?
Contact us for a trade discount!

EB45R-Sn-Flower Specifications	Vertical Flower Refrigerator with Illuminated Advertising Sign
Flower Cabinet	Designed to extend the shelf life of fresh flowers
Capacity	1384 Litres (Gross)
Dimensions	1640W x 762D x 2220H
Weight	265 Kg
Florist Benefits	Temperature Management for flowers
Colours	Ebony Black, and Snow White
Power Point	220 - 240v 50Hz. (Standard GPO)
Input Current	3.2 Amps
Thermometer	Digital
Shelves	12 Height Adjustable Heavy Duty PVC Coated
Shelves	3 Fixed Stainless Steel Base Shelves
Shelf Adjustment	12mm Increments
Door	3 x Self Closing, Double Glazed Safety Glass, Double Heat reflective Low E, Warm edge
Footings	Heavy Duty Castors, Lockable Front
Interior Light	LED, Automatic and manual control
Refrigerant	R134a
Cabinet Classes	3M1, 4M1, 5M1
MEPS	Compliant (High Efficiency)
* Energy Consumption	6.03 kWh/24h
Condenser Filter	Easy front access
Illuminated Advertising	200mm High, Top Mounted
Sign Illumination	LED, Automatic and manual control

RRP : \$5907 + GST
EB45R-Sn-A-Flower

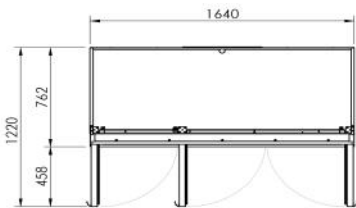

IP Protected by AUS DSN no 345317 & Patent NO 2013100761

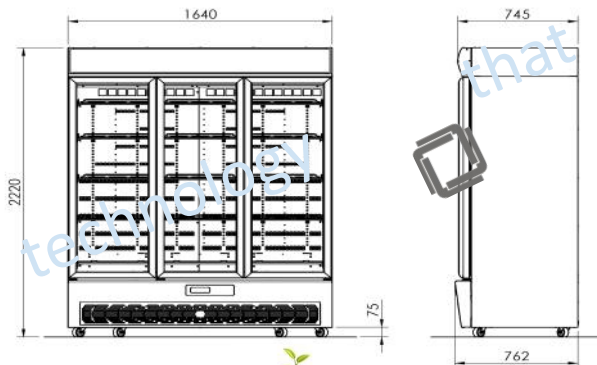

Daily running costs based on power costs of .28c per kW

- \$1.53 per day with sign box off
- \$1.69 per day with sign box on



Flower Fridges 4 U

For more information on the Orford Group flower Range including features & benefits refer to

www.flowerfridges4u.com.au





The Orford Flower Fridge Range now comes in a Rear Loading version.

Position your Flower Fridge next to your counter allowing customers to access from the front doors while you continue to restock from the rear doors

RRP : \$4622 + GST

Orford EB30R-Sn-Flower- Pass Thru

RRP : \$5193 + GST

Orford EB36R-Sn-Flower- Pass Thru

RRP : \$6480 + GST

EB45R-Sn-Flower- Pass Thru



For more information on the Orford Group flower Range including features & benefits refer to

www.flowerfridges4u.com.au

Do you have an ABN?
Contact us for a trade discount!





Economy Wine Range

Do you have an ABN?
Contact us for a trade discount!

FMB20-Sn-Wine	Vertical Display Refrigerator with Illuminated Advertising Sign
Construction	Powder Coated galvanized steel Int / Ext White
Capacity	557Litres (Gross)
Dimensions	740W x 791D x 2200H
Weight	165Kg
Operating Temp	0° - 5° C.
Ambient Temp Range	0° - 40° C.
Power Point	230 - 240v 50Hz. (Standard GPO)
Thermometer	Digital Carel Controller
Shelves	4 Height Adjustable Heavy Duty PVC Coated
Shelf Adjustment	12mm Increments
Door	Self Closing, Double Glazed Safety Glass, Argon filled Single Heat reflective Low E, Right Hand hinged.
Footings	Heavy Duty Castors, Lockable Front
Compressor	Danfoss
Interior Light	LED (on/off switch included)
Refrigerant	R134A
Insulation	50mm Polyurethane, CFC, HCFC, HFC Free
Climate Class	Class 5
MEPS	Compliant (High Efficiency)
Condenser Filter	Rear mounted
Illuminated Advertising Sign	200mm High, Top Mounted.
Sign Illumination	LED

Orford FMB20Sn-wine
RRP : \$2745 + GST



FMB30-Sn-Wine	Vertical Display Wine Refrigerator with Illuminated Advertising Sign
Construction	Powder Coated galvanized steel Int/ Ext White
Capacity	889 Litres (Gross)
Dimensions	1130W x 791D x 2200H
Weight	210Kg
Operating Temp	0° - 5° C.
Ambient Temp Range	0° - 40° C.
Power Point	230 - 240v 50Hz. (Standard GPO)
Thermometer	Digital Carel Controller
Shelves	8 Height Adjustable Heavy Duty PVC Coated
Shelf Adjustment	12mm Increments
Door	Self Closing, Double Glazed Safety Glass, Argon filled Single Heat reflective Low E, Right Hand hinged.
Footings	Heavy Duty Castors, Lockable Front
Compressor	Danfoss
Interior Light	LED (on/off switch included)
Refrigerant	R134A
Insulation	50mm Polyurethane, CFC, HCFC, HFC Free
Climate Class	Class 5
MEPS	Compliant (High Efficiency)
Condenser Filter	Rear mounted
Illuminated Advertising Sign	200mm High, Top Mounted.
Sign Illumination	LED

Orford FMB30Sn-Wine
RRP : \$3408 + GST





PlanetSmart™ EB Wine Range

Do you have an ABN?
Contact us for a trade discount!

EB20R-Sn-Wine Specifications	Vertical Display Wine Refrigerator with Illuminated Advertising Sign
Construction	Powder Coated galvanized steel Interior / Exterior White
Capacity	595 Litres (Gross)
Dimensions	756W x 762D x 2220H
Weight	155Kg
Operating Temp	0° - 5° C.
Ambient Temp Range	0° - 40° C.
Power Point	220 - 240v 50Hz. (Standard GPO)
Input Current	2.8 Amps
Thermometer	Digital
Shelves	4 Height Adjustable Heavy Duty PVC Coated
Shelves	1 Fixed Stainless Steel Base Shelves
Shelf Adjustment	12mm Increments
Refrigerated Shelf Area	1.42 m ²
Condensate Disposal	Automatic by energy efficient, No Cost, Hot Gas
Door	1 x Self Closing, Double Glazed Safety Glass, Double Heat reflective Low E, Warm edge, R/H
Footings	Heavy Duty Castors, Lockable Front
Interior Light	LED, Automatic and manual control
Refrigerant	R134a
Drier	Solid Core
Insulation	50mm Polyurethane, CFC, HCFC, HFC Free
Cabinet Classes	3M1, 4M1, 5M1
MEPS	Compliant (High Efficiency)
* Energy Consumption	3.43 kWh/24h
Condenser Filter	Easy front access
Illuminated Advertising Sign	200mm High, Top Mounted
Sign Illumination	LED, Automatic and manual control

RRP : \$3800 + GST
Orford EB20R-Sn-A-Wine

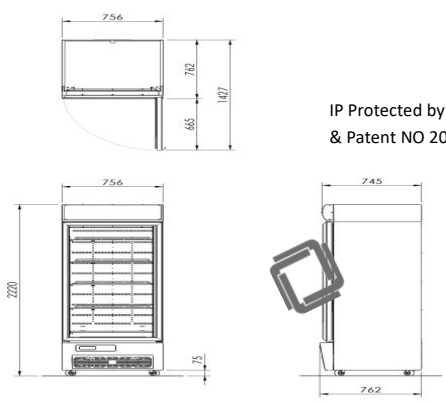

IP Protected by AUS DSN no 345317
& Patent NO 2013100761



The Orford Group EB20 Wine Cabinet	Energy Consumption @3M1 kWh/24hr
EB20R-SN-A with sign	3.43





PlanetSmart™ EB Wine Range

Do you have an ABN?
Contact us for a trade discount!

EB30R-Sn-wine Specifications	Vertical Wine Display Refrigerator with Illuminated Advertising Sign
Construction	Powder Coated galvanized steel Interior /Exterior White
Capacity	895 Litres (Gross)
Dimensions	1094W x 762D x 2220H
Weight	210Kg
Operating Temp	0° - 5° C.
Ambient Temp Range	0° - 40° C.
Power Point	220 - 240v 50Hz. (Standard GPO)
Input Current	2.8 Amps
Thermometer	Digital
Shelves	8 Height Adjustable Heavy Duty PVC Coated
Shelves	2 Fixed Stainless Steel Base Shelves
Shelf Adjustment	12mm Increments
Refrigerated Shelf Area	2.17 m ²
Condensate Disposal	Automatic by energy efficient, No Cost, Hot Gas
Door	2 x Self Closing, Double Glazed Safety Glass, Double Heat reflective Low E, Warm edge
Footings	Heavy Duty Castors, Lockable Front
Interior Light	LED, Automatic and manual control
Refrigerant	R134a
Cabinet Classes	3M1, 4M1, 5M1
MEPS	Compliant (High Efficiency)
* Energy Consumption	4.24 kWh/24h
Condenser Filter	Easy front access
Illuminated Advertising	200mm High, Top Mounted
Sign Illumination	LED, Automatic and manual control

RRP : \$4324 + GST
EB30R-Sn-A-wine



Bar Fridges 4 U
www.barfridges4u.com.au

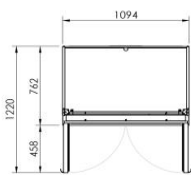

IP Protected by AUS DSN no 345317
& Patent NO 2013100761

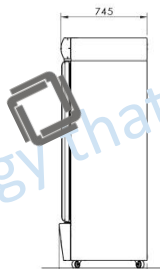
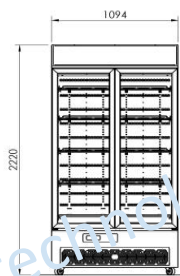

The Orford Group EB Model

Energy Consumption
@3M1 kWh/24hr

EB30R-SN-A with sign

4.24





Do you have an ABN?
Contact us for a trade discount!

EB36R-Sn-Wine Specifications	Vertical Wine Refrigerator with Illuminated Advertising Sign
Wine Cabinet	
Capacity	1071 Litres (Gross)
Dimensions	1286W x 762D x 2220H
Weight	221Kg
Florist Benefits	Temperature Management for flowers
Colours	Ebony Black, and Snow White
Power Point	220 - 240v 50Hz. (Standard GPO)
Input Current	2.9 Amps
Thermometer	Digital
Shelves	8 Height Adjustable Heavy Duty PVC Coated
Shelves	2 Fixed Stainless Steel Base Shelves
Shelf Adjustment	12mm Increments
Door	2 x Self Closing, Double Glazed Safety Glass, Double Heat reflective Low E, Warm edge
Footings	Heavy Duty Castors, Lockable Front
Interior Light	LED, Automatic and manual control
Refrigerant	R134a
Cabinet Classes	3M1, 4M1, 5M1
MEPS	Compliant (High Efficiency)
* Energy Consumption	4.74 kWh/24h
Condenser Filter	Easy front access
Illuminated Advertis-	200mm High, Top Mounted
Sign Illumination	LED, Automatic and manual control

RRP : \$4786 + GST
EB36R-Sn-A-Wine

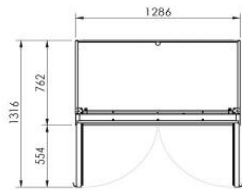

IP Protected by AUS DSN no 345317
& Patent NO 2013100761



Bar Fridges 4 U
www.barfridges4u.com.au

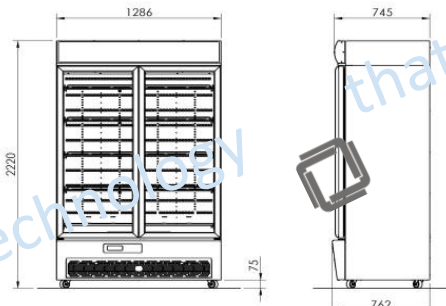

Daily running costs based on power costs of .28c per kW

- \$1.20 per day with sign box off
- \$1.33 per day with sign box on

For more information on the Orford Group Wine and Bar Range including features & benefits refer to





PlanetSmart™ EB Wine Range

Do you have an ABN?
Contact us for a trade discount!

EB45R-Sn-Wine Specifications	Vertical Wine Refrigerator with Illuminated Advertising Sign
Wine Cabinet	
Capacity	1384 Litres (Gross)
Dimensions	1640W x 762D x 2220H
Weight	265 Kg
Florist Benefits	Temperature Management for flowers
Colours	Ebony Black, and Snow White
Power Point	220 - 240v 50Hz. (Standard GPO)
Input Current	3.2 Amps
Thermometer	Digital
Shelves	12 Height Adjustable Heavy Duty PVC Coated
Shelves	3 Fixed Stainless Steel Base Shelves
Shelf Adjustment	12mm Increments
Door	3 x Self Closing, Double Glazed Safety Glass, Double Heat reflective Low E, Warm edge
Footings	Heavy Duty Castors, Lockable Front
Interior Light	LED, Automatic and manual control
Refrigerant	R134a
Cabinet Classes	3M1, 4M1, 5M1
MEPS	Compliant (High Efficiency)
* Energy Consumption	6.03 kWh/24h
Condenser Filter	Easy front access
Illuminated Advertising	200mm High, Top Mounted
Sign Illumination	LED, Automatic and manual control

RRP : \$5907 + GST
EB45R-Sn-A-Wine



Daily running costs based on power costs
of .28c per kW

- \$1.53 per day with sign box off
- \$1.69 per day with sign box on

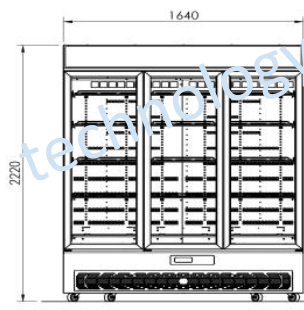
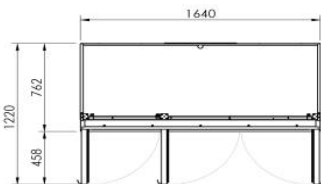

IP Protected by AUS DSN no 345317
Patent NO 2013100761

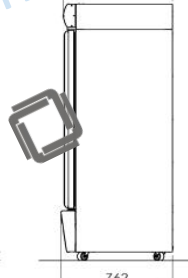

Bar Fridges 4 U
www.barfridges4u.com.au

For more information on the Orford Group Bar and Wine
Range including features & benefits refer to



Do you have an ABN?
Contact us for a trade discount!

EB30R-CC-Sn Specifications	Vertical Display Choc Refrigerator with Illuminated Advertising Sign
Construction	Powder Coated galvanized steel Interior /Exterior White
Capacity	895 Litres (Gross)
Dimensions	1094W x 762D x 2220H
Weight	210Kg
Operating Temp	12° - 18° C.
Ambient Temp Range	0° - 40° C.
Power Point	220 - 240v 50Hz. (Standard GPO)
Input Current	2.8 Amps
Thermometer	Digital
Shelves	8 Height Adjustable Heavy Duty PVC Coated
Shelves	2 Fixed Stainless Steel Base Shelves
Shelf Adjustment	12mm Increments
Refrigerated Shelf	2.17 m ²
Condensate Disposal	Automatic by energy efficient, No Cost, Hot Gas
Door	2 x Self Closing, Double Glazed Safety Glass, Double Heat reflective Low E, Warm edge
Footings	Heavy Duty Castors, Lockable Front
Interior Light	LED, Automatic and manual control
Refrigerant	R134a
Cabinet Classes	3M1, 4M1, 5M1
MEPS	Compliant (High Efficiency)
* Energy Consump-	4.24 kWh/24h
Condenser Filter	Easy front access
Illuminated Advertis-	200mm High, Top Mounted
Sign Illumination	LED, Automatic and manual control

RRP : \$4324 + GST

EB30CC-Sn

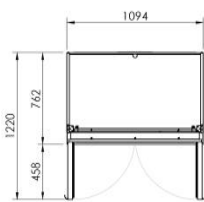

IP Protected by AUS DSN no 345317
& Patent NO 2013100761

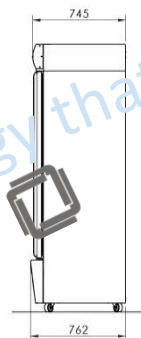
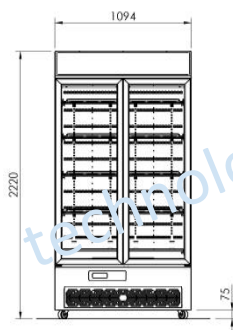

The Orford Group EB Model

Energy Consumption
@3M1 kWh/24hr

EB30R-A 3.78

EB30R-SN-A with
illuminated sign 4.24

For more information on the Orford Refrigeration Chocolate
Fridge Range including features & benefits refer to

www.orford.com.au



Do you have an ABN?
Contact us for a trade discount!

EB36R-CC-Sn Specifications	Vertical Display Choc Refrigerator with Illuminated Advertising Sign
Construction	Powder Coated galvanized steel Interior /Exterior White
Capacity	1071 Litres (Gross)
Dimensions	1286W x 762D x 2220H
Weight	221Kg
Operating Temp	12° - 18° C.
Ambient Temp Range	0° - 40° C.
Power Point	220 - 240v 50Hz. (Standard GPO)
Input Current	2.9 Amps
Thermometer	Digital
Shelves	8 Height Adjustable Heavy Duty PVC Coated
Shelves	2 Fixed Stainless Steel Base Shelves
Shelf Adjustment	12mm Increments
Door	2 x Self Closing, Double Glazed Safety Glass, Double Heat reflective Low E, Warm edge
Footings	Heavy Duty Castors, Lockable Front
Interior Light	LED, Automatic and manual control
Refrigerant	R134a
Drier	Solid Core
Insulation	50mm Polyurethane, CFC, HCFC, HFC Free
Cabinet Classes	3M1, 4M1, 5M1
MEPS	Compliant (High Efficiency)
* Energy Consumption	4.74 kWh/24h
Condenser Filter	Easy front access
Illuminated Advertising	200mm High, Top Mounted
Sign Illumination	LED, Automatic and manual control

RRP : \$4786 + GST
EB36CC-Sn

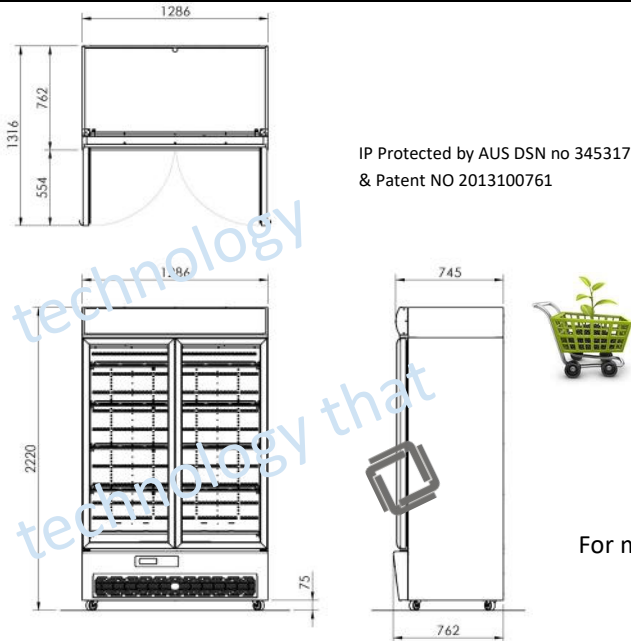

The Orford Group EB Model	Energy Consumption @3M1 kWh/24hr
EB36R-A	4.28
EB36R-SN-A with illuminated sign	4.74

For more information on the Orford Refrigeration Chocolate Fridge Range including features & benefits refer to

www.orford.com.au



Do you have an ABN?
Contact us for a trade discount!

EB45R-Sn Specifications	Vertical Display Refrigerator with Illuminated Advertising Sign
Construction	Powder Coated galvanized steel Interior / Exterior White
Capacity	1384 Litres (Gross)
Dimensions	1640W x 762D x 2220H
Weight	265 Kg
Operating Temp	12° - 18° C.
Ambient Temp Range	0° - 40° C.
Power Point	220 - 240v 50Hz. (Standard GPO)
Input Current	3.2 Amps
Thermometer	Digital
Shelves	12 Height Adjustable Heavy Duty PVC Coated
Shelves	3 Fixed Stainless Steel Base Shelves
Shelf Adjustment	12mm Increments
Refrigerated Shelf Area	3.38 m ²
Condensate Disposal	Automatic by energy efficient, No Cost, Hot Gas 3 x Self Closing, Double Glazed Safety Glass,
Door	Double Heat reflective Low E, Warm edge
Footings	Heavy Duty Castors, Lockable Front
Interior Light	LED, Automatic and manual control
Refrigerant	R134a
Cabinet Classes	3M1, 4M1, 5M1
MEPS	Compliant (High Efficiency)
* Energy Consumption	6.03 kWh/24h
Condenser Filter	Easy front access
Illuminated Advertising	200mm High, Top Mounted
Sign Illumination	LED, Automatic and manual control

RRP : \$5907 + GST
EB45CC-Sn

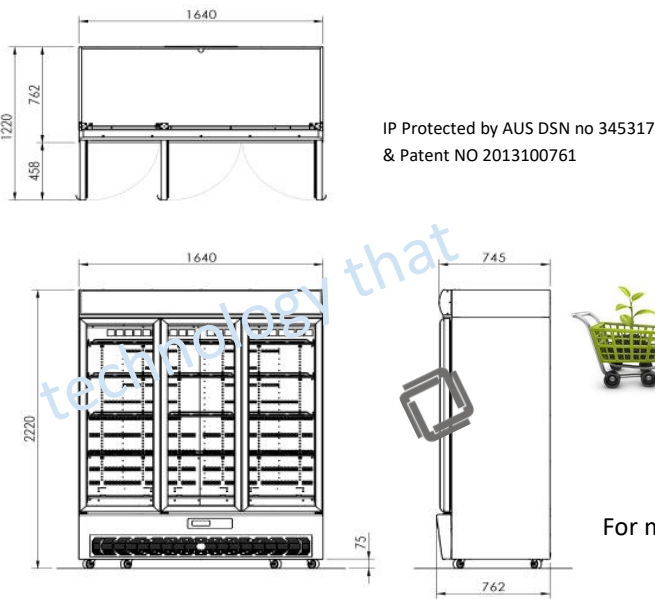

The Orford Group EB Model	Energy Consumption
EB45R-A	5.45
EB45R-SN-A with illuminated sign	6.03

For more information on the Orford Refrigeration Chocolate Fridge Range including features & benefits refer to

www.orford.com.au



**Orford Bakery &
Cake Display**



Do you have an ABN?
Contact us for a trade discount!

KK1500-3 Specifications	Cake Display—Tower Style
Construction	Stainless Steel—internal / external
Capacity	850 Litres (Gross)
Dimensions	1500 W x 800 D x 1300 H (mm)
Weight	280 Kg (net)
Operating Temp	2° to 8° C.
Ambient Temp Range	0° - 32° C.
Power Point	220 - 240v 50Hz. (Standard GPO)
Input Current	5.6 Amps
Thermometer x 2	Digital at rear and inside cabinet
Shelves	2 Height Adjustable Heavy Duty glass
Refrigerated Shelf Area	2.62 m ²
Rear Door	2 x Ezy slide doors
Footings	Heavy Duty Castors, Lockable Front
Interior Light	LED
Refrigerant	R404a Charge 630g
Drier	Solid Core
Fan	EBM Fans
Switches	Separate lighting and cabinet switches
Compressor	Embraco
Cleaning Filter	Ezy pull out filter for cleaning
Insulation	60mm Polyurethane, CFC, HCFC, HFC Free

Orford KK1500-3 Cake Display

RRP : \$ 6868 + GST



Display cakes beautifully in the Orford KK cake fridge

www.orford.com.au

sales@orford.com.au

1300 673 673



www.orford.com.au



Café & Cake KK Range

Do you have an ABN?
Contact us for a trade discount!



Features a cleaning filter



Features a second digital controller in the cabinet space



Features a digital controller operational from the rear of the cabinet



Display cakes beautifully in the Orford cake Display Cabinets

www.orford.com.au

sales@orford.com.au

1300 673 673

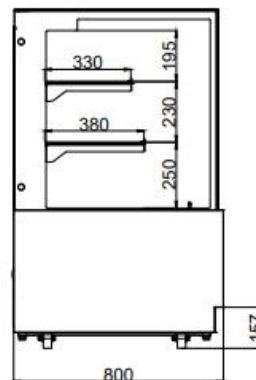
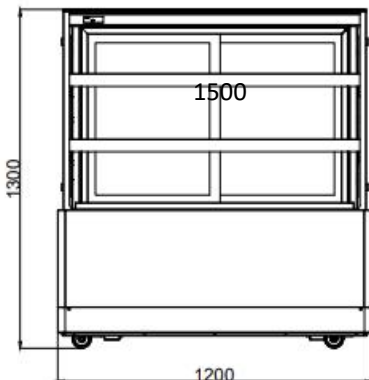



VB36L-Sn-IM ICE Freezer

Do you have an ABN?
Contact us for a trade discount!

VB36L-Sn-A-Ice Specifications	Vertical Display Ice Freezer with Illuminated Advertising Sign
Construction	Powder Coated galvanized steel Interior /Exterior White
Capacity	1071 Litres (Gross)
Dimensions	1286W x 866 D (+82 overhang = 952mm total) x 2215H (mm)
Weight	250 Kg (net)
Operating Temp	-19° to -23° C.
Ambient Temp Range	0° - 40° C.
Power Point	220 - 240v 50Hz. (15AMP power outlet)
Input Current	6.3 Amps
Thermometer	Digital
Shelves	8 Height Adjustable Heavy Duty PVC Coated
Shelves	2 Fixed Stainless Steel Base Shelves
Shelf Adjustment	12mm Increments
Refrigerated Shelf Area	2.62 m ²
Condensate Disposal	Automatic by energy efficient, No Cost, Hot Gas 2 x Self Closing, Triple Glazed Safety Glass, Argon filled with
Full Handled Door	Double Heat reflective Low E, Warm edge with removable torsion bar, heated frame
Footings	Heavy Duty Castors, Lockable Front
Interior Light	LED, Automatic and manual control
Refrigerant	R404a
Drier	Solid Core
Insulation	60mm Polyurethane, CFC, HCFC, HFC Free
Cabinet Classes	3L1, 4L2, 5L3 up to 40 degree Celsius ambient
MEPS	Compliant (High Efficiency)
* Energy Consumption	20.73 kWh/24h/m2
Condenser Filter	Easy front access
Illuminated Advertising Sign	205mm High, Top Mounted
Sign Illumination	LED, Automatic (motion sensor control) and manual control
Temperature Alarms	High and low temperature alarms
HACCP Function	Alarm system
Defrost	Energy Efficient Hot Gas
Sign Illumination	LED, Automatic and manual control

Orford VB36LSn—IM ICE Freezer

RRP : \$ 8885 + GST

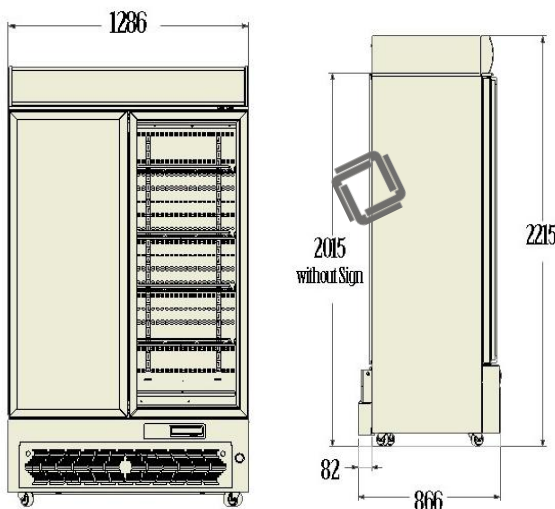

The Orford Group VB Freezer Model	Energy Consumption @3L1 kWh/24hr
VB36L-Sn-IM	20.73

Maximise Ice Sales with the Orford Bottom Mount Ice Freezer with a removable package.

Matches the Orford EB Range

100% designed by the Orford Engineering Team

Patent Protected in Australia & New Zealand

www.orford.com.au



The Orford Minus22 Freezer Series



Do you have an ABN?
Contact us for a trade discount!

Orford FML-20-BIce Freezer

RRP \$4275 + GST



Orford Freezer FML20	Vertical Display Ice Freezer
Specifications	
Construction	Powder Coated galvanized steel Interior /Exterior White standard (black optional when
FML-20	1 DOOR FREEZER
Capacity	560 Litres (gross)
Dimensions	750 w x 760 D x 2039 H (mm) (B models onwards)
Weight	150kg (net)
Temp	-6c---10c
Doors	1 x Self Closing, Triple Glazed Safety Glass, Argon filled with Double Heat reflective Low E,
Ambient temp	32c degrees
Weight	166 Kg (net)
Power Point	220—240v (1 x 10 AMP powerpoint)
* Energy Consumption	12.7 kWh/24h/m2
Common Specifications	FML20 / FML30 / FML50
Compressor	Danfoss
Thermometer	Digital Elitech Controller
Shelves per door	5 Height Adjustable Heavy Duty PVC Coated
Shelf Adjustment	12mm Increments
Condensate Disposal	Automatic by energy efficient, No Cost, Hot Gas
Footings	Heavy Duty 2.5mm Castors, Lockable Front
Interior Light	LED light with light switch
Refrigerant	R290 Natural Refrigerant (B models onwards)
Drier	Solid Core to suit
Insulation	60mm Polyurethane, CFC, HCFC, HFC Free
Cabinet Classes	
Condenser Filter	Easy front access
Security	Freezer has lock and key
Drip Tray Evaporation	Hot Gas
Method	
Kick Panel	Easy unclip and remove system
Defrost	Energy Efficient Hot Gas
Compliance	MEPS, EMC,



The Orford Minus22 Freezer Series



Do you have an ABN?
Contact us for a trade discount!

<i>Orford Freezer FML30</i>	2 Door Vertical Display ice Freezer
Specifications	
Construction	Powder Coated galvanized steel Interior /Exterior White (please check stock)
FML-30	2 DOOR FREEZER
Capacity	930 Litres (gross)
Dimensions	1253 w x 760 D x 2039 H (mm)
Weight	240 kg (net)
Doors	2 x Self Closing, Triple Glazed Safety Glass, Argon filled with Double Heat reflective Low E,
Temp	6c—-10c (Suitable for Ice)
Ambient Temperature	32 degrees
Power Point	1 x 15 AMP plug
* Energy Consumption	22.4 kWh/24h/m2
Common Specifications	FML20 / FML30 / FML50
Compressor	Danfoss
Thermometer	Digital Elitech Controller
Shelves per door	5 Height Adjustable Heavy Duty PVC Coated
Shelf Adjustment	12mm Increments
Condensate Disposal	Automatic by energy efficient, No Cost, Hot Gas
Footings	Heavy Duty 2.5mm Castors, Lockable Front
Interior Light	LED light
Refrigerant	R290 Natural Refrigerant (B models onwards)
Drier	Solid Core
Insulation	60mm Polyurethane, CFC, HCFC, HFC Free
Cabinet Classes	
Condenser Filter	Easy front access
Security	Freezer has lock and key
Drip Tray Evaporation Method	Hot Gas
Kick Panel	Easy unclip and remove system
Defrost	Energy Efficient Hot Gas
Compliance	MEPS, EMC,

Orford FML-30-B Ice Freezer

RRP \$5567 + GST



The Orford FML Freezer Series



Do you have an ABN?
Contact us for a trade discount!

<i>Orford Freezer FML50</i>	3 Door Vertical Display ice Freezer
Specifications	
Construction	Powder Coated galvanized steel Interior /Exterior White (please check stock)
FML-50	3 DOOR FREEZER
Capacity	1450 Litres (gross)
Dimensions	1880 w x 760 D x 2039 H (mm)
Weight	305 kg (net)
Doors	3 x Self Closing, Triple Glazed Safety Glass, Argon filled with Double Heat reflective Low E,
Temp	6c—-10c (Suitable for Ice)
Ambient Temperature	32 degrees
Power Point	1 x 15 AMP plug
* Energy Consumption	34.3 kWh/24h/m2
Common Specifications	FML20 / FML30 / FML50
Compressor	Danfoss
Thermometer	Digital Elitech Controller
Shelves per door	5 Height Adjustable Heavy Duty PVC Coated
Shelf Adjustment	12mm Increments
Condensate Disposal	Automatic by energy efficient, No Cost, Hot Gas
Footings	Heavy Duty 2.5mm Castors, Lockable Front
Interior Light	LED light
Refrigerant	R290 Natural Refrigerant (B models onwards)
Drier	Solid Core
Insulation	60mm Polyurethane, CFC, HCFC, HFC Free
Cabinet Classes	
Condenser Filter	Easy front access
Security	Freezer has lock and key
Drip Tray Evaporation Method	Hot Gas
Kick Panel	Easy unclip and remove system
Defrost	Energy Efficient Hot Gas
Compliance	MEPS, EMC,

Orford FML50-B Ice Freezer

R290 Natural Refrigerant

RRP \$6920 + GST





under bench
/bar series



Do you have an ABN?
Contact us for a trade discount!



Alfresco Dining with ORFORD

The Orford Back Bar Cooler Range

The perfect choice for your Alfresco area. The cabinets can be built fully into your cabinet or wall cavity

Energy efficient. Outdoor rated, tested to 32 degrees

The Orford Back Bar Range is part of the Orford

PlanetSmart Range—saving the planet one fridge at a time



Orford BB135	135 Litre Back Bar RRP \$2010 + GST
Construction	Stainless Steel interior & Exterior
Capacity	135 Litres (Gross)
Dimensions	600.W x 500 D + 45mm handle x 865 H
Weight	55 Kg
Operating Temp	0° - 10° C.
Ambient Temp Range	0° - 32° C.
Power Point	220 - 240v 50Hz. (Standard GPO)
Input Current	8.2 Amps
Thermometer	Digital Carel Eco Controller
Shelves	2 Height Adjustable
Door	1 x Low E glass doors with heated door mullion
Fans	EBM fans
Condenser	Fin type—60 gram R600 refrigerant
Interior Light	LED
IP Rating	IP23

Orford BB210	210 Litre Back Bar RRP \$2480 + GST
Construction	Stainless Steel interior & Exterior
Capacity	210 Litres (Gross)
Dimensions	900.W x 500 D + 45mm handle x 865 H
Weight	75 Kg
Operating Temp	0° - 10° C.
Ambient Temp Range	0° - 32° C.
Power Point	220 - 240v 50Hz. (Standard GPO)
Input Current	9.2 Amps
Thermometer	Digital Carel Eco Controller
Shelves	4 Height Adjustable
Door	2 x Low E glass doors with heated door mullion
Fans	EBM fans
Condenser	Tube condenser—48 gram refrigerant
Interior Light	LED
IP Rating	IP34



Do you have an ABN?
Contact us for a trade discount!



- Body Finish : 304 Stainless
- Interior Finish : Polished 304 Mirror Stainless
- Door Finish : 304 Stainless
- Door Mullion : Heated
- Door Hinged : Self Closing
- Door Opened Depth : 910mm
- Decibel rating : 50
- Double Glazed tempered door. Low E glass
- Can operate in 40 degrees ambient
- Famous parts : Carel Eco controllers, EBM fans, Embraco compressor
- Door Locks

Orford Back Bars Alfresco dining just got better

- Lockable : Yes
- Lighting : LED lights
- Adjustable Feet : Yes (4)
- Shelves : 2 x flat chromed adjustable shelves per door
- MEPS compliant
- CTick compliant
- IP34 Outdoor rated
- Allow 5 - 10 mm Shadowline when building into cabinetry
- Low E Glass Doors



Orford BB325	325 Litre Back Bar RRP \$3465 + GST
Construction	Stainless Steel interior & Exterior
Capacity	325 Litres (Gross)
Dimensions	1350 W x 500 D + 45mm handle x 865 H
Weight	110 Kg
Operating Temp	0° - 10° C.
Ambient Temp Range	0° - 32° C.
Power Point	220 - 240v 50Hz. (Standard GPO)
Input Current	9.2 Amps
Thermometer	Digital Carel Eco Controller
Shelves	6 Height Adjustable
Door	3 x Low E glass doors with heated door mullion
Fans	EBM fans
Interior Light	LED



Do you have an ABN?
Contact us for a trade discount!



Orford Back Bars
Alfresco dining just got better



Model	H mm	W mm	D mm	Gross Weight KGs	Refrigerant	Shelves	Capacity litres	330ml Bottles	Power Consumption (at 25 degrees ambient)
BB135	865	600	500 +45mm handle	55	R600a	2	135	104	1.93Kwh/24hrs
BB210	865	900	500 + 45mm handle	69	R600a	4	210	169	2.68Kwh/24hrs
BB325	865	1350	500 + 45mm handle	90	R600a	6	325	260	4.22Kwh/24hrs



Door locks standard



ebmpapst

German brand EBM fan motors for reliable service



Do you have an ABN?
Contact us for a trade discount!



Halo KUR9-1 (HC)	198 Litre Underbench RRP \$3,670 + GST
Construction	Stainless Steel interior & Exterior (Front breathing)
Capacity	198 Litres (Gross)
Dimensions	900 W x 700 D x 850 mm H (on castors)
Weight	72 Kg
Operating Temp	0° - 10° C.
Ambient Temp Range	0° - 32° C.
Power Point	220 - 240v 50Hz. (Standard GPO) 1 x 10AMP plug
Input Current	3 Amps
Thermometer	LED Digital Display Soft Touch Controller
Shelves	1 Height Adjustable
Refrigerant	R290 Natural Refrigerant
Compressor	Left hand side Embraco Compressor

Halo KUR12-2 (HC)	311 Litre Underbench RRP \$4,200 + GST
Construction	Stainless Steel interior & Exterior—Front breathing
Capacity	311 Litres (Gross)
Dimensions	1200 W x 700 D x 850 mm H (on castors)
Weight	84 Kg
Operating Temp	0° - 10° C.
Ambient Temp Range	0° - 32° C.
Power Point	220 - 240v 50Hz. (Standard GPO) 1 x 10AMP plug
Input Current	3 Amps
Thermometer	LED Digital Display Soft Touch Controller
Shelves	2 x Height Adjustable
Refrigerant	R290 Natural Refrigerant
Compressor	Left hand side Embraco Compressor



Halo KUR15-2 (HC)	425 Litre Underbench RRP \$4,560 + GST
Construction	Stainless Steel interior & Exterior
Capacity	425 Litres (Gross)
Dimensions	1500 W x 700 D x 850 mm H (on castors)
Weight	93 Kg
Operating Temp	0° - 10° C.
Ambient Temp Range	0° - 32° C.
Power Point	220 - 240v 50Hz. (Standard GPO) 1 x 10AMP plug
Input Current	3 Amps
Thermometer	LED Digital Display Soft Touch Controller
Shelves	3 x Height Adjustable
Refrigerant	R134a
Compressor	Left hand side Embraco Compressor



Do you have an ABN?
Contact us for a trade discount!

Halo KUR18-3 Undercounter Specifications (HC)

Horizontal Undercounter Fridge \$5,080 + GST

Construction	Stainless steel exterior & interior
Capacity	538 Litre
Dimensions	1800 w x 700 d x 850 h (mm) on castors
Weight	109 kg
Operating Temp	0c to 8c,
Ambient Temp Range	Up to 32 degrees
Input Current	220V / 50Hz
Thermometer	LED Digital Display & Soft Touch Control
Shelves	3 shelves
Refrigerant	R290 Natural Refrigerant
Compressor	Embraco
Fans	EBM fans



Halo KUR24-4 Undercounter Specifications (HC)

Horizontal Undercounter Fridge \$7,270 + GST

Construction	Stainless steel exterior & interior
Capacity	640 Litre
Dimensions	2440 w x 700 d x 850 h (mm) on castors
Weight	122kg
Operating Temp	0c to 8c,
Ambient Temp Range	Up to 32 degrees
Input Current	220V / 50Hz 10 AMP
Thermometer	LED Digital Display & Soft Touch Control
Shelves	4 shelves
Refrigerant	R290 Natural Refrigerant
Compressor	Embraco
Fans	EBM fans

Do you have an ABN?
Contact us for a trade discount!



Halo KUF 9-1 (HC)	198 Lt Undercounter FREEZER \$3,890 + GST
Construction	All stainless steel 304 with left sided Embraco Compressor
Capacity	198 ltr
Dimensions	900 w x 700 d x 850 h (mm) On castors
Weight	72 kg
Operating Temp	- 21c to—12c degrees
Ambient Temp Range	32 degrees
Power Point	10 Amp plug
Input Current	500 w Refrigerant : R290 Natural Refrig
Thermometer	LED digital Display & Soft touch controller
Shelves	1 shelf

Halo KUF 12-2 (HC)	311 Lt Undercounter FREEZER \$4,710 + GST
Construction	All stainless steel 304 with left sided Embraco Compressor
Capacity	311 ltr
Dimensions	1200 w x 700 d x 850 h (mm) On castors
Weight	84 kg
Operating Temp	- 21c to—12c degrees
Ambient Temp Range	32 degrees
Power Point	10 Amp plug Refrigerant : R290 Natural Refrigerant
Input Current	366 w Refrigerant : R290 Natural Refrigerant
Thermometer	LED digital Display & Soft touch controller
Shelves	2 shelf



Halo KUF 15-2 (HC)	425 Lt Undercounter FREEZER \$5,020 + GST
Construction	All stainless steel 304 with left sided Embraco Compressor
Capacity	425 ltr
Dimensions	1500 w x 700 d x 850 h (mm) On castors
Weight	87 kg
Operating Temp	- 21c to—12c degrees
Ambient Temp Range	32 degrees
Power Point	10 Amp plug
Input Current	366 w Refrigerant : R290 Natural Refrigerant
Thermometer	LED digital Display & Soft touch controller
Shelves	2 shelf
Refrigerant	R290 Natural Refrigerant

Halo KUF 18-3 (HC)	538 Lt Undercounter FREEZER \$5,990 + GST
Construction	All stainless steel 304 with left sided Embraco Compressor
Capacity	538 ltr
Dimensions	1800 w x 700 d x 850 h (mm) On castors
Weight	109 kg
Operating Temp	- 21c to—12c degrees
Ambient Temp Range	32 degrees
Power Point	10 Amp plug Refrigerant : R290 Natural Refrigerant
Input Current	613 w 4.4 Amps
Thermometer	LED digital Display & Soft touch controller
Shelves	3 shelf
Refrigerant	R290 Natural Refrigerant



Do you have an ABN?
Contact us for a trade discount!

Halo KURF12-2	Undercounter FREEZER / FRIDGE \$5,440 + GST
Construction	All stainless steel 304 with left sided Embraco Compressor
Capacity	Freezer 134 Ltr / Fridge 136 ltr
Dimensions	1200 w x 700 d x 850 h (mm) On castors
Weight	87 kg
Operating Temp	Fridge 1—5 degrees / Freezer 21c to—12c degrees
Ambient Temp	32 degrees
Power Point	10 Amp plug
Input Current	316 w
Thermometer	LED digital Display & Soft touch controller
Shelves	2 shelf
Refrigerant	R290—Natural Refrigerant



Halo KURF15-2 (HC)	Undercounter FREEZER / FRIDGE \$5,750 + GST
Construction	All stainless steel 304 with left sided Embraco Compressor
Capacity	Freezer 177 Ltr / Fridge 189 ltr
Dimensions	1500 w x 700 d x 850 h (mm) On castors
Weight	96 kg
Operating Temp	Fridge 1—5 degrees / Freezer 21c to—12c degrees
Ambient Temp Range	32 degrees
Power Point	10 Amp plug
Input Current	316 w Refrigerant : R290—Natural Refrigerant
Thermometer	LED digital Display & Soft touch controller
Shelves	2 shelf
Refrigerant	R290—Natural Refrigerant

Halo KURF18-3 (HC)	Undercounter FREEZER / FRIDGE \$6,420 + GST
Construction	All stainless steel 304 with left sided Embraco Compressor
Capacity	Freezer 151 Ltr / Fridge 314 ltr
Dimensions	1800 w x 700 d x 850 h (mm) On castors
Weight	96 kg
Operating Temp	Fridge 1—5 degrees / Freezer 21c to—12c degrees
Ambient Temp Range	32 degrees
Power Point	10 Amp plug
Input Current	316 w Refrigerant : R290—Natural Refrigerant
Thermometer	LED digital Display & Soft touch controller
Shelves	2 shelf
Refrigerant	R290—Natural Refrigerant





halo®

Halo KGR Refrigerator

Halo KGR9—1 door (HC) Specifications (HC)

Horizontal Undercounter Fridge \$4,280 + GST

Capacity	137 Litre
Dimensions	900 w x 700 d x 850 h (mm) on castors
Weight	80 kg on castors
Operating Temp	0c to 8c,
Ambient Temp Range	Up to 28 degrees
Input Current	220V / 50Hz 10 AMP
Thermometer	LED Digital Display & Soft Touch Control
Doors & Shelves	1 door with LOW E glass and 1 shelf
Refrigerant	R290 Natural Refrigerant



Halo KGR12—2 door (HC) Specifications

Horizontal Undercounter Fridge \$ 5,530 + GST

Capacity	311 Litre
Dimensions	1200 w x 700 d x 850 h (mm) on castors
Weight	80 kg on castors
Operating Temp	0c to 8c,
Temp Range	Up to 28 degrees ambient
Input Current	220V / 50Hz 10 AMP
Thermometer	LED Digital Display & Soft Touch Control
Doors & Shelves	2 doors with LOW E glass and 2 shelves
Refrigerant	R290

Do you have an ABN?
Contact us for a trade discount!





Halo KGR Refrigerator

Do you have an ABN?
Contact us for a trade discount!

<i>Halo KGR15—2 door</i> Specifications (HC)	Horizontal Undercounter Fridge \$5,790 + GST
Capacity	425 Litre
Dimensions	1500 w x 700 d x 850 h (mm) on castors
Weight	90 kg on castors
Operating Temp	0c to 8c,
Ambient Temp Range	Up to 28 degrees
Input Current	220V / 50Hz 10 AMP
Thermometer	LED Digital Display & Soft Touch Control
Doors & Shelves	2 door with LOW E glass and 2 shelf
Refrigerant	R290 Natural Refrigerant



<i>Halo KGR18—3 dr</i> Specifications (HC)	Horizontal Undercounter Fridge \$6,890 + GST
Capacity	538 Litre
Dimensions	1800 w x 700 d x 850 h (mm) on castors
Weight	127 kg on castors
Operating Temp	0c to 8c,
Temp Range	Up to 28 degrees ambient
Input Current	220V / 50Hz 10 AMP
Thermometer	LED Digital Display & Soft Touch Control
Doors & Shelves	3 door with LOW E glass and 3 shelves
Refrigerant	R290

<i>Halo KGR24—4dr</i> Specifications (HC)	Horizontal Undercounter Fridge \$8,510 + GST
Capacity	600 Litre
Dimensions	2400 w x 700 d x 855 h (mm) on castors
Weight	145 kg on castors
Operating Temp	0c to 8c,
Temp Range	Up to 28 degrees ambient
Input Current	220V / 50Hz 10 AMP
Thermometer	LED Digital Display & Soft Touch Control
Doors & Shelves	3 door with LOW E glass and 3 shelves
Refrigerant	R290





food
service

Do you have an ABN?
Contact us for a trade discount!

Halo KRF 25-2 (HC)	664 Litre Combo RRP \$5,970 + GST
Construction	Stainless Steel interior & Exterior top Mount
Capacity	Freezer 242 Litres plus Fridge 222 Litres = 664 Ltre
Dimensions	640 W x 860 D x 1926 mm H (on castors)
Weight	85 Kg
Operating Temp	Fridge—1° - 10° C. Freezer - 21° - 12° C.
Ambient Temp Range	0° - 32° C.
Power Point	220 - 240v 50Hz. (Standard GPO) 1 x 10AMP plug
Input Current	4.4 Amps
Thermometer	LED Digital Display Soft Touch Controller
Shelves	2 x Height Adjustable
Refrigerant	R290 Natural Refrigerant
Compressor	Two compressor system

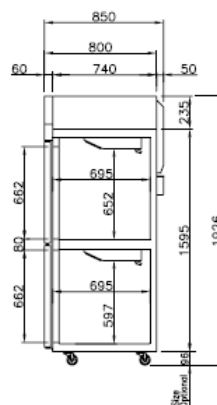

SIDE VIEW

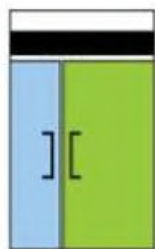

Halo KRF 45-2 (HC)	1109 Litre Combo RRP \$8,565 + GST
Construction	Stainless Steel interior & Exterior top Mount
Capacity	Freezer 464 Litres plus Fridge 645 Litres = 1109 Ltre
Dimensions	1260 W x 800 D x 1926 mm H (on castors)
Weight	150 Kg
Operating Temp	Fridge—1° - 8° C. Freezer - 21° - 12° C.
Ambient Temp Range	0° - 32° C.
Power Point	220 - 240v 50Hz. (Standard GPO) 1 x 15 AMP plug
Input Current	Fridge - 4.4 Amps Freezer—6.73 Amps 15amp
Thermometer	LED Digital Display Soft Touch Controller
Shelves	2 x Height Adjustable
Refrigerant	R290 Natural Refrigerant
Compressor	Two compressor system



Do you have an ABN?
Contact us for a trade discount!

Halo KRF 45-4	Dual Temp Fridge / Freezer RRP \$9,100 + GST
Construction	Stainless Steel Top Mount
Capacity	Freezer 464 litres / fridge 642 Litres = 1106 Litres
Dimensions	1260 w x 860 d x 1935 h (including castors)
Weight	150 kg
Operating Temp	Fridge 1°C to 8°C Freezer— -21°C to -12°C
Ambient Temp Range	Up to 32°C ambient temperature
Power Point	15 Amp Australian plug
Input Current	Fridge—R-134A 4.4amps power—w673,
Thermometer	Digital
Shelves	3 per side (6 in total)
Refrigerant	R290 Natural Refrigerant
Compressor	Two compressor system



Halo KRF 65—3	Dual Temp Fridge / Freezer RRP \$11,470 + GST
Construction	Stainless Steel Top Mount
Capacity	Freezer 555 litres / fridge 1275 Litres = 1830 Litres
Dimensions	1900 w x 860 d x 1935 h (including castors)
Weight	250 kg
Operating Temp	Fridge 1°C to 8°C Freezer— -21°C to -12°C
Ambient Temp Range	Up to 32°C ambient
Power Point	15 Amp Australian plug
Input Current	Fridge—R-134A 4.4amps power—w673
Thermometer	Digital
Shelves	3 per door (9 in total)
Refrigerant	R290 Natural Refrigerant
Compressor	Two compressor system

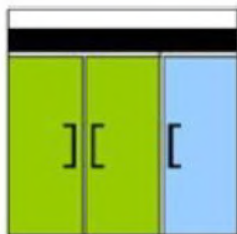



halo®

Food Service Storage Cabinets

Do you have an ABN?

Contact us for a trade discount!



Model	Temp	Doors	Net Volume	Shelves	Dimensions	Power 220v 50Hz	Shipping Weight
Halo KR25-1	Refrigerator 1~ 8 degrees	1	574	3	640w x 850d x 1926h	314w	115
Halo KF25-1	Freezer -21 ~ -12 degrees	1	574	3	640w x 850d x 1926h	496w	120
Halo KR45-2	Refrigerator 1 ~ 8 degrees	2	1215	6	1260w x 850d x 1926h	366w	190
Halo KF45-2	Freezer -21~ -12 degrees	2	1215	6	1260w x 850d x 1926h	774w	200
Halo KR65-3	Refrigerator 1—8 degrees	3	1876	9	1900w x 850d x 1926h	732w	280
Halo KF65-3	Freezer -21 ~ 12 degrees	3	1876	9	1900w x 850d x 1926h	1346w	280

Note : the depth includes 50mm for the rear condensate tray

Orford
REFRIGERATION



Do you have an ABN?
Contact us for a trade discount!

Orford
REFRIGERATION



The K Series Features

- Designed to 40 Degrees ambient operating temperature
- Requires one standard power point : - 240V 50Hz 10 amp
- Digital Temperature Display
- 3 height adjustable shelves per door. Individual shelves behind each door maximize storage configurations
- Stainless steel construction for superior corrosion resistance
- Stainless steel internal floor with coved corners allows for easy cleaning and sanitizing
- Large castors for ease of cabinet movement
- Solid lockable doors. Designed with recessed handle and self closing hinging with 90 degree dwell feature
- LED interior lighting
- One piece door gaskets, removable without tools for easy cleaning
- Automatic energy efficient hot gas condensate disposal. No drainage required
- Internal Pressure release valve



Do you have an ABN?
Contact us for a trade discount!



Halo KR25-1 (HC)	574 Ltr Refrigerator RRP \$5,010 + GST
Construction	Stainless Steel Top Mount
Capacity	574 Litre
Dimensions	640 w x 850 d x 1926 h (incl castors)
Weight	80kg
Operating Temp	1c to 8c
Ambient Temp Range	32 degrees ambient
Power Point	10 Amp
Input Current	Amps 3.5 Power - W366
Thermometer	Digital
Shelves	3 adjustable
Refrigerant	R290 Natural Refrigerant

Halo KR45—2 (HC)	1215 Ltr Refrigerator RRP \$6,070 + GST
Construction	Stainless Steel Top Mount
Capacity	1215 Litre
Dimensions	1130 w x 850 d x 1926 h (incl castors)
Weight	80kg
Operating Temp	1c to 8c
Ambient Temp Range	32 degrees ambient
Power Point	10 Amp
Input Current	Amps 3.5 Power - W366
Thermometer	Digital
Shelves	4 adjustable
Refrigerant	R290 Natural Refrigerant



Halo KR65—3 (HC)	1876 Ltr Refrigerator RRP \$9,300 + GST
Construction	Stainless Steel Top Mount
Capacity	1876 Litre
Dimensions	1900 w x 850 d x 1926 h (incl castors)
Weight	167 kg
Operating Temp	1c to 8c
Ambient Temp Range	32 degrees ambient
Power Point	10 Amp
Input Current	Amps 3.5 Power - W366
Thermometer	Digital
Shelves	6 adjustable
Refrigerant	R290 Natural Refrigerant





halo®

KF Freezer

Do you have an ABN?
Contact us for a trade discount!



Halo KF25-1F	574 ltr Freezer RRP \$5,430 + GST
Construction	Stainless steel inner & outer Top Mount
Capacity	574 litre
Dimensions	640 w x 850 d x 1926 h (including castors)
Weight	80 kg
Operating Temp	-12c to -25c
Ambient Temp Range	36 degrees ambient
Power Point	10 Amps
Input Current	Power - W496 10 Amp
Thermometer	Digital
Shelves	3 adjustable
Refrigerant	R-290 Natural Refrigerant

Halo KF45-2F (HC)	1215 ltr Freezer RRP \$7,940 + GST
Construction	Stainless steel inner & outer Top Mount
Capacity	1215 litre
Dimensions	1260 w x 850 d x 1926 h (including castors)
Weight	142 kg
Operating Temp	-12c to -25c
Ambient Temp Range	36 degrees ambient
Power Point	10 Amps
Input Current	Power - W496 10 Amp
Thermometer	Digital
Shelves	6 adjustable
Refrigerant	R-290 Natural Refrigerant



Halo KF65-3F (HC)	1876 ltr Freezer RRP \$10,480 + GST
Construction	Stainless steel inner & outer Top Mount
Capacity	1876 litre
Dimensions	1900 w x 850 d x 1926 h (including castors)
Weight	167 kg
Operating Temp	-12c to -25c
Ambient Temp Range	36 degrees ambient
Power Point	15 Amps
Input Current	Power - W496 10 Amp
Thermometer	Digital
Shelves	9 adjustable
Refrigerant	R-290 Natural Refrigerant

Orford
REFRIGERATION



Do you have an ABN?
Contact us for a trade discount!



<i>Halo KHR9-1 (FB)</i>	Salad Table with Hood Lid RRP \$4,390 + GST
Specifications	
Construction	Stainless Steel—Front Breathing
Capacity	213 Litres
Dimensions	900 w x 700 d x 1134 h (with castors)
Weight	100 kg
Operating Temp	0° - 5° C.
Ambient Temp Range	0° - 32° C.
Power Point	220 - 240v 50Hz. (Standard GPO)
Input Current	2.5 Amps
Condiment Pans	1/6 size pans, 100mm deep plastic condiment pans
Shelves	1 shelf per door
Cutting Boards	204 mm deep, 12 mm thick cutting board
Temperature Controller	Digital Controller
Air Curtain	Cold air curtain forcing air to flow around the food pan area, covering underneath the pan and front, top and
Doors	1 Door with Door locks standard
Refrigerant	R290 Natural Refrigerant

<i>Halo KHR12-2</i>	Salad Table with Hood Lid RRP \$5,220 + GST
Specifications	
Construction	Stainless Steel
Capacity	309 Litres
Dimensions	1200 w x 700 d x 1134 h (with castors)
Weight	100 kg
Operating Temp	0° - 5° C.
Ambient Temp Range	0° - 32° C.
Power Point	220 - 240v 50Hz. (Standard GPO)
Input Current	3 Amps
Power	314 W
Condiment Pans	1/6 size pans, 100mm deep plastic condiment pans
Shelves	1 shelf per door
Cutting Boards	204 mm deep, 12 mm thick cutting board
Temperature Controller	Digital Controller
Air Curtain	Cold air curtain forcing air to flow around the food pan area, covering underneath the pan and front, top and rear
Doors	2 Doors with Door locks standard
Refrigerant	R290



Do you have an ABN?
Contact us for a trade discount!

<i>Halo KHR15-2 (FB)</i>	
Specifications	Salad Table with Hood Lid RRP \$5,760 + GST
Construction	Stainless Steel
Capacity	420 Litres
Dimensions	1500 w x 700 d x 1134 h (with castors)
Weight	100 kg
Operating Temp	0° - 5° C.
Ambient Temp Range	0° - 32° C.
Power Point	220 - 240v 50Hz. (Standard GPO)
Input Current	3 Amps
Power	314 W
Condiment Pans	1/6 size pans, 100mm deep plastic condiment pans
Shelves	1 shelf per door
Cutting Boards	204 mm deep, 12 mm thick cutting board
Temperature Controller	Digital Controller
Air Curtain	Cold air curtain forcing air to flow around the food pan area, covering underneath the pan and front, top and rear
Doors	2 Doors with Door locks standard
Refrigerant	R290



<i>Halo KHR18-3 (FB)</i>	
Specifications	Salad Table with Hood Lid RRP \$6,720 + GST
Construction	Stainless Steel
Capacity	516 Litres
Dimensions	1800 w x 700 d x 1134 h (with castors)
Weight	102 kg
Operating Temp	0° - 5° C.
Ambient Temp Range	0° - 32° C.
Power Point	220 - 240v 50Hz. (Standard GPO)
Input Current	4.4 Amps
Power	366 W
Condiment Pans	1/6 size pans, 100mm deep plastic condiment pans
Shelves	1 shelf per door
Cutting Boards	204 mm deep, 12 mm thick cutting board
Temperature Controller	Digital Controller
Air Curtain	Cold air curtain forcing air to flow around the food pan area, covering underneath the pan and front, top and rear
Doors	3 Doors with Door locks standard
Refrigerant	R290

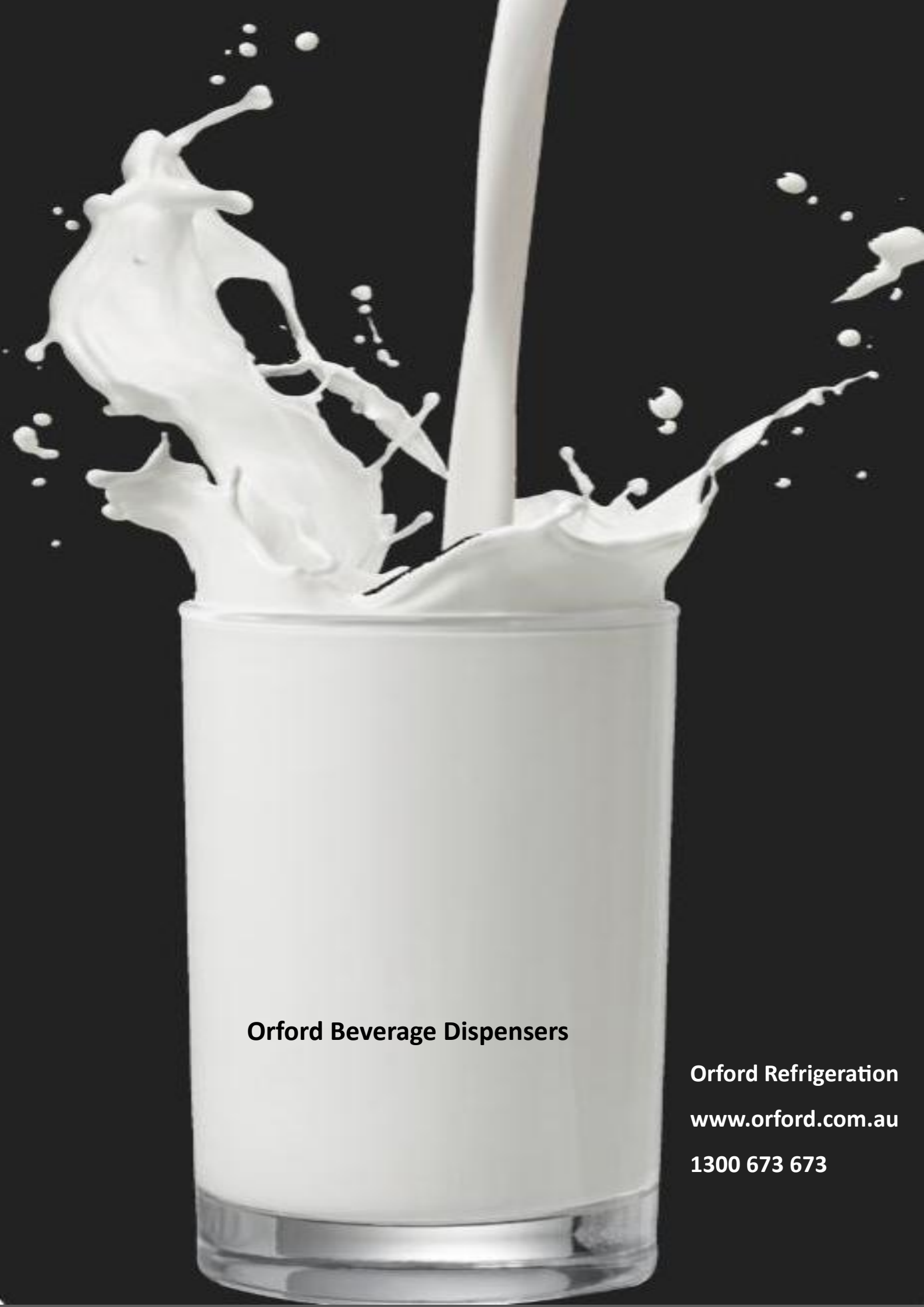

Orford Beverage Dispensers

Orford Refrigeration

www.orford.com.au

1300 673 673

Do you have an ABN?
Contact us for a trade discount!

Orford BD20— Refrigerated Premix dispenser RRP \$980 + GST

The Orford BD20 is a dual pour chilled beverage dispenser ideal for storing, chilling and dispensing beverage and is built to withstand the demands of high traffic areas such as Hotels, Resorts, Clubs, Pubs, Cafeterias, etc

Operates at +2 degrees to + 10 at 30 deg ambient temp and 60% humidity

Features

- stores two x 10Lt packages of beverage simultaneously
- Light box display
- Strong durable colorbond metal liner easy to clean and rust resistant
- The outlet pipeline is surrounded by a shield
- Dual pour



full plastic removable door



removable door gasket



door lock



full plastic dispensing



Water tray with position sign



dispensing detail



Package shelf with guide



sealed outlet

Orford BD20

Refrigerated Premix Dispenser

Construction	Powder coated galvanised steel—white
Capacity	20Lt 2 x 10Lt Milk bladders
Dimensions	386 w x 572 d x 901 h (mm)
Weight	35kg
Operating Temp	2 to 10 degrees
Ambient Temp Range	0 to 30 degrees
Power Point	220—240 v 50Hz (Standard GPO) 155W
Pouring Control System	Manual Lever Control system
Controller	Mechanical
Switches	Refrigeration switch and lamp switch are separate
Energy Consumption	0.85 kWh / 24hrs
Dispensing Levers	2
Climate Class	4
Stuffing quantity (20'/40')	114 / 230
Refrigerant	R600a (24g)





Do you have an ABN?
Contact us for a trade discount!

Orford BD20A Auto — Refrigerated Premix dispenser

RRP \$1250 + GST

The Orford BD20A Auto is a dual pour chilled beverage dispenser ideal for storing, chilling and dispensing beverage and is built to withstand the demands of high traffic areas such as Hotels, Resorts, Clubs, Pubs, Cafeterias, etc

Operates at +2 degrees to + 10 at 30 degrees ambient temp and 60% humidity

Features

- stores two x 10Lt packages of beverage simultaneously
- Light box display
- Electronic control system. The millilitres dispensed can be controlled
- Strong durable colorbond metal liner easy to clean and is rust resistant
- The outlet pipeline is surrounded by a shield
- A removable partition can be adjusted to accommodate cups at different heights
- Dual pour



<i>Orford BD20A Auto</i>	Refrigerated Premix Dispenser
Construction	Powder coated galvanised steel—white
Capacity	20Lt 2 x 10Lt Milk bladders
Dimensions	386 w x 572 d x 901 h (mm)
Weight	35kg
Operating Temp	2 to 10 degrees
Ambient Temp Range	0 to 30 degrees
Power Point	220—240 v 50Hz (Standard GPO) 195W
Pouring Control System	Electronic Control system with controlled milk pourer
Climate Class	4
Controller	Mechanical
Switches	Refrigeration switch and lamp switch are separate
Energy Consumption	0.85 kWh / 24hrs
Refrigerant	R600a



Do you have an ABN?
Contact us for a trade discount!

Gravity Mats and Dividers and Ticket Stripping

Features & Benefits

- ⇒ Fully customisable system to fit any product mechanising application
- ⇒ Unique wave surface increases efficiency and product flow
- ⇒ Retro-fit to existing cabinet fleets
- ⇒ Low profile design to maximise shelf space and product access
- ⇒ Designed and manufactured in Australia

Email : sales@orford.com.au

Phone : 1300 673 673 (1300 ORFORD)

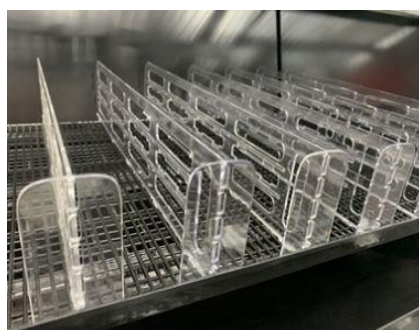

Do you have an ABN?
Contact us for a trade discount!

Gravity Feed Systems Suits EB20 / FMB20 (Single Door) RRP - \$246.15+ GST

- Excludes freight and Installation and excludes ticket stripping
- 5 x Gravity Mats
- 30 Dividers
- 10 Cable Ties

Gravity Feed Systems Suits EB30 / FMB30 (Slim 2 Door) RRP - \$445.30 + GST

- Excludes freight and Installation and excludes ticket stripping
- 10 x Gravity Mats
- 50 Dividers
- 20 Cable Ties



Product Pricing Ticket Strips—Per Shelf \$6.80 + GST

- Pricing is per shelf
- Ticket stripping slips over the existing shelf product stoppers
- To be ordered separately to the gravity feed systems



Do you have an ABN?
Contact us for a trade discount!

Gravity Feed Systems Suits EB36 (2 Door) RRP - \$448.40 + GST

- Excludes freight and Installation and excludes ticket stripping
- 10 x Gravity Mats
- 60 X Dividers
- 20 X Cable Ties

Gravity Feed Systems Suits EB45 (3 Door) RRP - \$665.80 + GST

- Excludes freight and Installation and excludes ticket stripping
- 15 x Gravity Mats
- 75 Dividers
- 30 X Cable Ties



Product Pricing Ticket Strips—Per Shelf \$6.80 + GST

- Pricing is per shelf
- Ticket stripping slips over the existing shelf product stoppers
- To be ordered separately to the gravity feed systems



ice machines



HALF DICE



Hard, clear ice cube with unique "rhomboid" shape 3/8" x 1-1/8" x 7/8" (0.95 x 2.86 x 2.22 cm) in dimension, 96 cubes per pound of ice, maximum cooling with nearly 100% ice to water ratio.

DICE



Hard, clear ice cube with unique "rhomboid" shape 7/8" x 7/8" x 7/8" (2.22 x 2.22 x 2.22 cm) in dimension, 48 cubes per pound of ice, maximum cooling with nearly 100% ice to water ratio.

REGULAR



Hard, clear ice cube with unique "rhomboid" shape 1-1/8" x 1-1/8" x 7/8" (2.86 x 2.86 x 2.22 cm) in dimension, 32 cubes per pound of ice, maximum cooling with nearly 100% ice to water ratio.

GOURMET



Hard, clear, individual ice cube with unique octagon shape 1-3/8" x 1-3/8" (3.49 x 3.49 cm) in dimension, maximum cooling with nearly 100% ice to water ratio.



NUGGET



Easy to chew but hard enough to be dispensed without hand scooping, 3/8" (.95 cm) to 1/2" (1.27 cm) in width and length on average.

TUBULAR NUGGET



Softer texture with good cooling. Cylindrical shaped nugget with 5/8" (1.59 cm) diameter and average length of 1" (2.54 cm) with 90% ice to water ratio.

FLAKE



Small, soft pieces of ice with a 73% ice to water ratio. Perfect for displaying products and hand scooping into drinks.

CRUSHED



Manitowoc dice or half dice cubes crushed into small pieces using a Manitowoc ice machine and a Servend® beverage dispenser equipped with icepic™ ice crusher.



Manitowoc Ice Machines

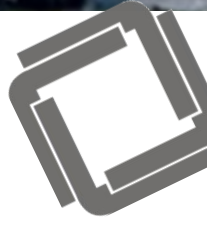

SOTTO
The clear and simple choice.

Manitowoc

Model	21 Air / 10 Water	32 Air / 21 Water	Storage Capacity	Dimensions H x W x D cm	RRP ex GST
UG30	31kg	25kg	5.5 KG	65 X 45 X 48	2950
UG50	57kg	43KG	14 KG	80 X 55 X 55	3690
UG65	65kg	58KG	30 KG	90 X 70 X 60	4060
UG80	85kg	67KG	30 KG	90 X 70 X 60	4390
Levellers supplied with all models (adjustable)					
Optional adjustable Legs (set of 4)			K00345001	10.1—15.2	200

24 HOUR Production Octagonal Gourmet Ice Cubes All units 10amp Power (with 1.82 mt lead)

Uses gravity to drain water away

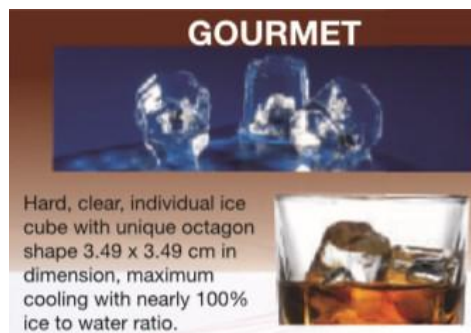

UG80



Manitowoc Undercounter Cubers

NEO

The everywhere you need ice machine.

Manitowoc

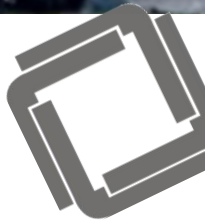

Model	21 air / 10 water	32 air / 21 water	Storage Capacity	Dimensions H x W x D cm	RRP Price Ex GST
UDE0080A—Full dice Gravity drain	46KG	32KG	14KG	94.04 X 50 X 56.7	4160
NEO-u140	55KG	41KG	40KG	97.8 X 66 X 71.1	5320
NEO-u190	79KG	60KG	36KG	97.8 X 66 X 71.1	5530
NEO-u240	87KG	68KG	36KG	97.8 X 66 X 71.1	5830
NEO-u310	132KG	103KG	45KG	97.8 X 76.2 X 71.5	7420
LEGS X 4 K00445	30MM			Optional	120

Standard legs supplied—Adjustable 15.24—20.33 All units 10Amp power with 2.43 mt Lead

Neo models available in full and half dice at the same price

Specs quoted as all Full dice. Half dice available on request

The U080 replaces the QM45



INDIGO® | Intelligent thinking inside the box.

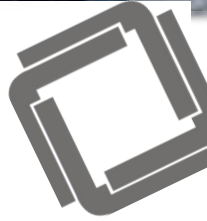

24Hr production. Full and Half cubes available.

Only Full dice quoted below. Please phone or email for other models.

Model	21 Air / 10 water	32 Air / 21 water	Dimensions (ex bin)	RRP exc GST
Modular Width	H x W x D cm			
IDT-0620 Full Dice (10 Amp)	243 kg	195 kg	55 x 55.9 x 62	7580
IYT-0620 Half Dice (10 Amp)	243 kg	195 kg		7580

Bin models to suit

i-620 : A320, D420c or D570C* (*requires adapter plate 040004915 RRP \$400 + GST)

A320, D420c or D570c ** (**requires adaptor plate K00470 RRP \$790 + GST)

Model	Storage Capacity	Dimensions	RRP exc GST
D320	120KG	96.5 X 55.9 X 86.4	1910
D420c	174KG	127 X 55.9 X 86.4	2110
D570C	210KG	127 X 76.2 X 86.4	2380

Standard legs supplied with bins—Adjustable 15.24—20.33

All units suit 10 Amp Australian plugs with a 1.82mt lead



Phone : 1300 673 673

Email : sales@orford.com.au



INDIGO | Intelligent thinking inside the box.

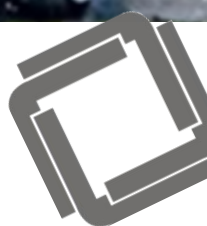

24Hr production. Full and Half cubes available.

Model	21 Air / 10 water	32 Air / 21 water	Dimensions	RRP exc GST
Regular Width			H x W x D cm	
IDT-0500A—Full dice 10Amp	227 KG	175 KG	55 X 76.2 X 63	7720
IDT-0750A —Full dice 10Amp	291 KG	251 KG	55 X 76.2 X 63	9290
IYT-0750A —Half dice 10Amp	306 kg	265 kg		
IDT-0900A—Full dice 15 Amp	381KG	312KG	68 X 76.2 X 63	12100
IDY-0900A—Half dice 15 Amp	378kg	336kg		
IDT1200A—Full dice 15 Amp	542KG	429KG	75 X 76.2 X 63	13900
IDY1200A—Half dice 15 Amp	544kg	424kg		

I450 & I606 10Amp power / I906 & I1106 15 Amp power 1.83mt Lead

Bin models to suit

Adaptor Plate for i-322, i-522 on A400v, A570V bin

K00472 (K00365) \$400 + GST

Adaptor plate for IDT-0450—IDT1200A on A970v Bin

K00470 (K00458) \$670 + GST

Model	Storage Capacity	Dimensions	RRP exc GST
A400	166kg	96.5 x 76.2 x 86.4	2090
D570C	241kg	127 x 76.2 x 86.4	2380
D970C	360kg	127 x 121.9 x 86.4	3390





Manitowoc Ice Machines

INDIGO | Intelligent thinking inside the box.

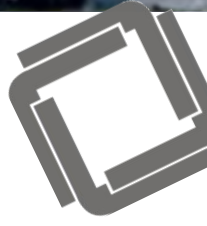

Indigo Series I-1400 Ice Machine on B-970 Bin



INDIGO



Indigo NXT Series iT1900 Ice Machine on D970 Bin



S-3070C Ice Machine - 115V



CVD Condensing Unit - 208-230/60/3



INDIGO | Intelligent thinking inside the box.

24Hr production. Full and Half cubes available.

Only Full dice quoted below. Please phone or email for other models.

Model	21 Air / 10 water	32 Air / 21 water	Dimensions	RRP exc GST
The Wide Boys		H x W x D cm		
iT-1500 20Amp	782 kg	574 kg	74.93 x 121.9 x 62.20	\$15,670
NXT i-1900 Hard wired	828 kg	615 kg	74.93 x 121..9 x 62.20	\$21,810

Bin models to suit

I400-I800 : D970C or F1300

S3070 : F1300

Model	Storage Capacity	Dimensions	RRP exc GST
D970C	400 kg	127 x 121.9 x 86.4	3390
F1300	600 kg	161.3 x 121.9 x 78.7	10,150

Adaptor Plates

D570 bin uses K00472 (K00365) adaptor—RRP \$470+ GST

D970 bin uses K00470 (K00458) adaptor—RRP \$790 + GST



1300 673 673





Flakers



UFK0350A



VFK0200A

RFK0320A
Bin D420c



RFK062A
Bin D420c



RFK1300A
D570c bin





Flakers

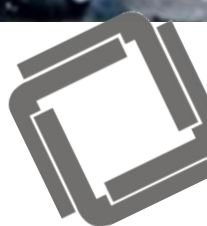

Under Counter Flakers—Head and Bin

Model	21 Air / 10 water	32 Air / 21 water	Storage Capacity	Dimensions H x W x D cm	RRP exc GST
UFK0200A—10Amp	77kg	63kg	27kg	95 x 50 x 66	\$8,080
UFK0350A—15Amp	152kg	122kg	40kg	101 x 74 x 69	\$8,500

Height includes legs. Standard adjustable legs are supplied 11.43—15.24cm

Modular Flakers—Head Only

Model	21 Air / 10 water	32 Air / 21 water	Dimensions	RRP exc GST
RFK0320A - 15Amp	174kg	130kg	66 x 56 x 60	\$8,380
RFK0620A—15Amp	305kg	248kg	66 x 56 x 60	\$10,740
RFK1300A—15Amp	545kg	396kg	70 x 76 x 60	\$14,500
RFS2378C—15Amp / 3hp Hard-	984kg	772kg	70 x 76 x 60	\$25,030

Bin to Suit

RFS300A : A320, A430, A570*

RFS1200 : D570C* D970C**

RFS650 : A420, A570*

RF2300 : F1300

*Requires adapter plate K00472

**requires adaptor plate K00470

Model	Storage Capacity	Dimensions H x W x D cm	RRP exc GST
A320	95kg	97 x 56 x 86	\$1910
D420C	141kg	127 x 56 x 86	\$2110
D570C*	210kg	127 x 76 x 86	\$2380
D970C	360kg	127 x 122 x 86	\$3390
F1300	600kg	162 x 122 x 79	\$10,150
*K-00472		Adaptor plate	470
K-00470		Adaptor plate	790

 **1300 673 673**



Dispensers

Modular Dispensers—Order Ice Maker Separately



Model	Storage Only	Dimensions—Dispenser Only H x W x D cm	RRP exc GST
SPA160 - Ice Dispenser 10 Amp	54kg	122 x 56 x 80	\$9,210
SFA291—Ice & Water Dispenser 10 Amp	82kg	139 x 76 x 82	\$12,240
SPA310—Ice Dispenser 10 Amp	82KG	138 X 76 X 82	\$11,030
DISP500T 10 Amp	250kg	163 x 76 x 134	\$26,200
DISP1000T 10 Amp	450kg	163 x 122 x 134	\$33,200



SFA Ice Dispenser comes with bin inclusive of water valve
With 2.43mt LEAD

- SPA Ice Only Dispenser
- SFA Ice & Water Dispenser
- SN12A 10 Amp Power
- SFA & APS Units 10 Amp Power
- T Timed Agitation



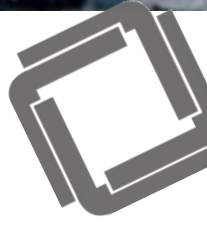

D320C



D400C



D420C



D570C



D970C



F1300





Model	Storage Only	Dimensions—Dispenser Only		RRP exc GST
		H x W x D cm		
D320c	120kg	97 x 56 x 86		\$1910
D400c	166kg	97 x 76 x 86		\$2090
D420c	174kg	127 x 56 x 86		\$2110
D570C	240kg	127 x 76 x 86		\$2380
K-00472 (K00365)	Adaptor Plate for i-322, i-522 on D400, D570 bin			\$470
D970C	400kg	127 x 122 x 86		\$3390
K-00470 (K00458)	Adaptor Plate for i-450—i1200 on D970 Bin			\$790
F1300	600kg	162 x 122 x 79		\$10,150
F1325	601kg	1368 x 152 x 79		\$10,410

Standard adjustable legs supplied with all models 15.24—20.33





Nugget Machines



VMK0200A—Nugget Ice Machine



RNK0320A—Nugget Head
Bin sold separately



RNK0620A—Nugget Head
Bin sold separately



UNK0300A Nugget ice machine



Undercounter Nugget—Nugget Machines

MODEL	MIN 24 HR ICE PRODUCTION		STORAGE CAPACITY	DIMENSIONS (W X D X H) MM	RRP PRICING EX GST
	21° AIR	32° AIR			
	10° WATER	21° WATER			

UNK0200A		78KG	53KG	18KG	500 X 660 X 840	\$10,760 + GST
----------	-----------------------------------------------------------------------------------	------	------	------	-----------------	----------------

10 Amp plug | Height includes legs | Standard adjustable legs are supplied (150—200mm)

UNK0300A		136KG	112KG	23KG	738 X 690 X 1000	\$11,950 + GST
----------	------------------------------------------------------------------------------------	-------	-------	------	------------------	----------------

15 Amp plug | Height includes legs | Standard adjustable legs are supplied (150—200mm)

Modular Nugget—Nugget Ice Machines—Head Only

MODEL	MIN 24 HR ICE PRODUCTION		HEAD ONLY DIMENSIONS (W X D X H) MM	RRP PRICING EX GST
	21° AIR	32° AIR		
	10° WATER	21° WATER		

RNK0320AA		143kg	114KG	559 X 600 X 660	\$10,080 + GST
-----------	-------------------------------------------------------------------------------------	-------	-------	-----------------	----------------

15 Amp plug | Bin model : D320 / D420

RNK0620A		266KG	204KG	559 X 600 X 660	\$12,590 + GST
----------	-------------------------------------------------------------------------------------	-------	-------	-----------------	----------------

15 Amp plug | Bin model : D420 / *D570 | *Requires Adapter Plate K00472

RNK1100A		474KG	374KG	762 X 600 X 696	\$19,380 + GST
----------	-------------------------------------------------------------------------------------	-------	-------	-----------------	----------------

15 Amp plug | Bin model : D570 / *D970 | *Requires Adapter Plate K00470



Manitowoc M Series

The Manitowoc M Series—simple with three controls—on, off and clean



Model	21 Air / 10 Water	32 Air / 32 Water	Dimensions W x D x H cm	RRP inc GST
M420 (10 Amp) Bin to suit : A320, A420 or K570 with adapter K00365	176kg	132kg	55.9 x 62.2 x 54.6	\$5930
M500 (10 Amp) Bin to suit : A400 or D570C	214kg	169kg	76.2 x 62.2 x 54.6	\$6380
M700 (15 Amp) Bin to suit : A400 or D570C	290kg	228kg	76.2 x 62.2 x 54.6	\$7390
M1000 (15 Amp) Bin to sit : D570C or D970C with adapter K00458	437kg	374kg	76.2 x 62.2 x 74.9	\$10,090
M1400 (20 Amp Hardwired) Bin to suit : A970	645kg	479kg	121.9 x 62.2 x 74.9	\$13,700



M Series are available in three convenient sizes 22" (55.9cm), 30" (76.2cm) and 48" (121.9cm) with 6 different production ranges from 420 lbs (176 kg) to 1400 lbs (649 kg) of ice

M series ice machines are designed from the ground up to meet your operational demands for a worry-free, simple-to-use, basic ice machine; but that doesn't mean corners were cut on quality.

There are only three controls you need: On, Off and Clean.

And for cleaning, access to the evaporator and food zone is simple with the removal of just two screws and easy, lift-off door.

1.83 MTR Lead





Accessories

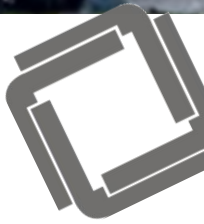

Indigo Model	Suitable for	RRP excl GST
--------------	--------------	--------------

Luminice 11 Growth inhibitor kit—K00450	i-322—i-1106	1,030
Luminice 11 Growth inhibitor kit—K00451	I-1406—i-1800	1,030
Lunimice 11 Growth Inhibitor kit—K00452	Neo U-140—U310	1,030

Filters	Suitable for	RRP excl GST
---------	--------------	--------------

BR10—Suit QM45, Sotto and Neo Model Indigo models	i-322—i-1106	210
BR20—Suit Indigo Models I-906—S3070	I-906—S3070	270
BR30 : Suit poor water areas		440

Adapter Plates	Suitable for	RRP excl GST
----------------	--------------	--------------

K00472	i-322 / i-522 to A400 / A570 bin	470
K00470	i-450 / i-1200 to A970 bin	790

Accessories	Suitable for	RRP excl GST
-------------	--------------	--------------

K00063—Castor kit for NEO machines	NEO Ice machines	640
K00461—External Ice Scoop Holder	All ice bins	273
14199—Ice Scoop with hand Guard	All ice bins	72





Castor Kits & Ice Baggers

Caster Kit	Suitable for	RRP excl GST
K00138	A400 / A570bin	720
K00063	Neo Ice Machines	370



Ice Bagger Assembly	Order Code	RRP excl GST
Ice Bagger	K00146	\$840

Manitowoc Commercial Warranty

Model	Parts	Labour
Sotto	2yr	1yr
Neo	5yr evaporators 5 year compressor 3 yr dispenser	5 year evaporators 3 year compressor 3 year dispenser
Indigo	5yr evaporators 5 year compressor 3 yr dispenser	5 year evaporators 3 year compressor 3 year dispenser
QM	3yr	3yr



Preserve Working Capital with Orford Finance

Phone 1300 673 673

Do you have an ABN?
Contact us for a trade discount!

YOURS TODAY:
EB20R-Sn-A



Weekly payments from
\$35

- ✓ Extensive lender panel
- ✓ Conserve working capital
- ✓ 24 hour approvals
- ✓ No financials required

Call Jessica on 1300 736 780 for more details.



*Subject to credit approval. Payments based on a lease contract over five years with a 5% residual. The lease amount has been rounded to the nearest dollar.

YOURS TODAY:
EB36R-Sn



Weekly payments from
\$36

- ✓ Extensive lender panel
- ✓ Conserve working capital
- ✓ 24 hour approvals
- ✓ No financials required

Call Jessica on 1300 736 780 for more details.



*Subject to credit approval. Payments based on a lease contract over five years with a 5% residual. The lease amount has been rounded to the nearest dollar.

YOURS TODAY:
EB45R-Sn



Weekly payments from
\$45

- ✓ Extensive lender panel
- ✓ Conserve working capital
- ✓ 24 hour approvals
- ✓ No financials required

Call Jessica on 1300 736 780 for more details.



*Subject to credit approval. Payments based on a lease contract over five years with a 5% residual. The lease amount has been rounded to the nearest dollar.

YOURS TODAY:
FMB20-Sn



Weekly payments from
\$25

- ✓ Extensive lender panel
- ✓ Conserve working capital
- ✓ 24 hour approvals
- ✓ No financials required

Call Jessica on 1300 736 780 for more details.



*Subject to credit approval. Payments based on a lease contract over five years with a 5% residual. The lease amount has been rounded to the nearest dollar.

YOURS TODAY:
FMB30



Weekly payments from
\$30

- ✓ Extensive lender panel
- ✓ Conserve working capital
- ✓ 24 hour approvals
- ✓ No financials required

Call Jessica on 1300 736 780 for more details.



*Subject to credit approval. Payments based on a lease contract over five years with a 5% residual. The lease amount has been rounded to the nearest dollar.



Promote your Brand — Phone 1300 673 673



Decal Sets

RRP — \$240 + GST

Orford can arrange for your artwork to be printed

2 long decals (side) + 2 short (front) decals

Email : sales@orford.com.au



Do you have an ABN?
Contact us for a trade discount!



Roderick Abif 1 Pty Ltd (ABN 72 150 865 008) Trading as Orford Refrigeration

1. TITLE

Risk in any goods supplied by the seller to the buyer shall pass when such goods are delivered to the buyer or into custody on the buyers behalf but the ownership of any goods supplied by the seller to the buyer shall remain with the seller until payment in full is made for the goods.

2. WARRANTIES AND REPRESENTATIONS

All new goods supplied are warranted to be free from defects in material and workmanship for a period of 12 months from time of invoice.

The seller is not liable for any injury, loss or damage, directly or consequential, arising out of the use of or the inability to use the goods. Before using, the buyer shall determine suitability of the goods for the buyers intended use and assume all risk and liability.

3. ACCEPTANCE

An offer or quotation by the seller shall become binding upon the seller upon written or verbal acceptance of the quote or of the goods discussed verbally. Acceptance of the goods is deemed to be acceptance of these terms and conditions.

4. REJECTION

Except for defective goods supplied by the seller, goods cannot be rejected. Goods damaged during transit on the buyers own transport are not covered by Orford Foods Services insurance.

5. MANUFACTURERS SPECIFICATION

Due to continuous improvement processes, product specifications may change without notice from time to time.

All pricing shown in Orford catalogues are exclusive of GST, freight and insurance.

6. FREIGHT

Orford Refrigeration offers a freight option on the following terms

- ⇒ goods are delivered to a loading dock or similar
- ⇒ All relevant details that could present a delivery challenge are revealed prior to the delivery
- ⇒ The carrier working on behalf of Orford Refrigeration has the right to refuse to complete the delivery if the site is found to be unsafe, cluttered, or the goods are unable to fit through door ways or if there are steps, stairs, or moats with crocodiles .

Do you have an ABN?
Contact us for a trade discount!



Do you have an ABN?
Contact us for a trade discount!

orford
REFRIGERATION

Warranty

Roderick Abif 1 Pty Ltd (ABN 72 150 865 008) Trading as Orford Refrigeration

This warranty applies for calls of a breakdown service nature only, for problems of manufacturing origin. Recalls, customer related problems (power supply fluctuations, thermostat adjustments, overstocking and over loading of shelves / baskets, choked condenser etc) and any other non warranty nature calls will be charged to the service call originator at normal full rates, payable at the time of the service call.

This warranty is voided, if the equipment has not been properly maintained in accordance with the manufacturers instructions supplied with the equipment, or the equipment has been subject to power supply fluctuations, misused or transported in a manner which could prejudice the correct operation of the appliance.

Orford does not reimburse or pay for costs relating to travel time, callout or attendance fees, overtime / penalty or premium labour rates or any other costs incurred or charged.

Orford does not reimburse for loss of stock, damage or expense directly or indirectly incurred.

Orford Refrigeration does not cover travel time in excess of one (1) hour and does not cover any work performed on equipment which is located OFF the Australian Mainland or Mainland Tasmania.

Orford does not cover labour costs of maintaining, adjusting or cleaning

Orford does not accept the cost of work undertaken without the permission of Orford

The standard Orford Refrigeration warranty on refrigeration cabinets and ice machines is 12 months parts and labour unless expressly agreed. This clause must be read within the context of all other clauses and not referred to exclusively.

Excluded from Orford warranty are all consumable items such as glass, gaskets, lights, elements, locks, keys, accessories, decals

All warranty work must be authorised in advance by contacting the Customer Service Department on

- ⇒ Phone 1300 673 673 (1300 ORFORD)
- ⇒ Email : mail@orford.com.au
- ⇒ [www. Orford.com.au](http://www.Orford.com.au)



Do you have an ABN?
Contact us for a trade discount!

CABINET CLASS is a combination of Climate Class and Temperature Class as per the requirements of Australian Standard AS1731

e.g.:- 3L1, 4L2, 5L3 etc.

CLIMATE CLASS defines the climatic ambient conditions for which the cabinet is suited.

Refer table below.

Climate Class	Ambient Temperature	Ambient Humidity
	°C	% RH.
3	25	60
4	30	55
5	40	40
6	27	70
7	35	75

TEMPERATURE CLASS defines the temperature at which the appliance is capable of maintaining product, at a particular Climate Class as per the requirements of Australian Standard AS1731.

Refer examples below:

L1

At the above climate class product temperatures can be maintained between -15°C and -18°C.

As per Australian Standard AS1731.5: 2003 and AS1731.6: 2003. 5 Table 1.

L2

At the above climate class product temperatures can be maintained between -12°C and -18°C.

As per Australian Standard AS1731.5: 2003 and AS1731.6: 2003. 5 Table 1.

L3

At the above climate class product temperatures can be maintained between -12°C and -15°C.

As per Australian Standard AS1731.5: 2003 and AS1731.6: 2003. 5 Table 1.





Minimum Energy Performance Standard (MEPS) Why it Matters



Do you have an ABN?
Contact us for a trade discount!

What are the Consequences if products do NOT comply

The regulator can

- ⇒ Suspend a model's registration
- ⇒ Cancel a models registration
- ⇒ Enforceable undertakings
- ⇒ Infringement notices
- ⇒ Civil penalty orders
- ⇒ Injunctions

The regulator can publicise details relating to enforcement responses including the names of registrants and the model numbers of the products

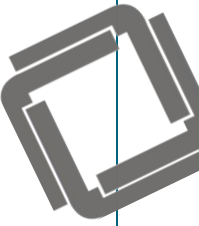

Protect Yourself

Check that the cabinet is registered for MEPS / GEMS

- ⇒ refer to the MEPS website reg.energyrating.gov.au/comparator/product_types
- ⇒ Research the cabinets MEPS figures on the MEPS website. If for example the MEPS figure is 5.8 (kWh/24hr/m²), this means the amount of total energy consumption over a 24 hour period per square metre of display area
- ⇒ If you cant find the cabinet on the MEPS site, assume it is NOT registered and therefore not legally able to be sold or used in Australia and / or New Zealand



Do you have an ABN?
Contact us for a trade discount!

Which cabinets are covered by the compulsory MEPS / GEMS

- Open Face
- Reach in cabinets
- Food & Deli display cabinets
- Bar Fridges
- Glass door Merchandisers



What are MEPS Ratings?

Reference [Http://www.orford.com.au/orford-eb-energy-figures.html](http://www.orford.com.au/orford-eb-energy-figures.html)

M1

At the above climate class product temperatures can be maintained between -1°C and +5°C.
As per Australian Standard AS1731.5: 2003 and AS1731.6: 2003. 5



M2

At the above climate class product temperatures can be maintained between -1°C and +7°C.
As per Australian Standard AS1731.5: 2003 and AS1731.6: 2003. 5





Do you have an ABN?
Contact us for a trade discount!

Orford Refrigeration

ABN 72 150 865 008

Head Office & Postal Address

382 South St, Harristown, Qld 4350

sales@orford.com.au

National sales Cabinets:

Free Call : 1300 ORFORD (1300 673 673)

Sales Office : 07 46 345 278

Corby Orford : 0418 700006

Jeff Ash : 0400 013 958

Email : sales@orford.com.au

Email : jeffash@theorfordgroup.com.au

Social Media

www.facebook.com/theorfordgroup

Key Websites :

www.orford.com.au

www.orfordspareparts.com.au

All images are subject to copyright and cannot be reproduced without permission

Orford Refrigeration Brisbane Office

39 Dunhill Crescent

Morningside, Qld, 4170

Phone : 1300 ORFORD (1300 673 673)

Open Monday & Tuesday by appointment

National Spare Parts Sales

Free Call : 1300 ORFORD (1300 673 673)

Email : parts@orford.com.au



Website : www.orford.com.au

www.facebook.com/orfordref

www.instagram.com/orfordrefrigeration/

Key Patents:

AUS DSN no 345317

Patent No 2013100761

“Orford” is protected by Trademark No 1452870

All efforts are made to ensure the accuracy of information, but from time to time errors may occur. Please check prior to placing orders. This publication serves as a guide to the Orford and partner products. Readers are encouraged to contact Orford prior to making final purchasing decisions

