

wir bewegen Ihr Leben
drive



bellavita

• Bathlift

CE

OPERATING INSTRUCTIONS

ENGLISH

Bellavita – Product description 3

 Scope 3

For your own safety 4

 Important information 4

 Notes concerning the storage battery, battery charger and hand control 4

 Important safety rules 5

 Notes concerning Electromagnetic Compatibility (EMC) 6

Installation and use 6

 Unpacking 6

 First installation in the bath 7

 Attaching and removing the covers 10

 Installing the headrest (optional) 11

 Hand control 12

 Operating the Bellavita in the bath 13

 Removing the lift from the bath 14

Maintenance and care 16

 Maintenance of the bathlift 16

 Cleaning 16

 Maintenance of seat covers 16

 Assembly of new cushion plugs for the bathlift covers 16

 Maintenance of the battery charger 17

 Charging the storage battery 17

Transport / mobile use 18

 Transport as two separate units 18

 Transport in an interlocked condition 18

Appendix 19

 Technical Data Bellavita bathlift 19

 Troubleshooting 21

 Notes concerning the disposal 21

 Re-use/Recycling 21

 Warranty 22

 Accessories and spare parts 23

 Explanation of symbols 24

 Type labels 24

 Notes concerning these operating instructions 24

Alphabetic Glossary 25

Notes 26

Thank you for deciding to buy a product made by Drive Medical. From now on, this lightweight, high-quality bathlift will make it a lot easier for you to get in and out of your bath.

This bathlift conforms to the legal standards DIN EN ISO 10535:2006 and DIN EN 60601-1:1996.

The Bellavita is built with high-quality, recyclable lightweight plastic. This makes our product easy to transport and stow away – and ideally suited for use in the home or away.

The lithium-ion battery is located in the hand control. The hand control itself can float in the water. The drive motor and control electronics are completely water tight, so you can use the Bellavita even with the shower on.

The sturdy frame dismantles, enabling the seat to be raised or lowered from 6 cm to 48 cm (2.4 to 18.9 in) height. The lifting rod lifts and lowers the seat surface when the user pushes the up and down buttons.

The drive unit with integrated backrest can be folded down for removal and automatically locks in to the seat base when the lift is raised. This prevents unintentional tilting of the backrest. Intelligent power control ensures that the lift can only be lowered if sufficient power is available to raise it again.

Scope

Bathing aids assist users with their daily hygiene. These aids compensate, in whole or in part, for restricted or lost physical functions. The goal of using such aids is to enable their users to be independent of help and to give them more privacy.

Bathlifts are used to lower and raise a user in the bath. Their use is recommended if the physical mobility of a person's upper and/or lower extremities is significantly reduced making it difficult to get into or out of the bath or to sit down and stand up safely. In these cases, the use of a bathlift is a great help to re-gain independence and privacy in the bathroom.



➤ **ATTENTION - VITAL INFORMATION!**

Fully read the instructions in this manual prior to use. Failure to do so may result in damage and/or injury.

▮ **Important information**

- Never use the Bellavita to climb in or out of the bath. Never use it as a stand, lifting device, ladder, support, or for any similar purposes outside of the bath. **The lift is to be used only in order to take a bath.**
- ALWAYS keep animals and children away from the bathlift.
- In the event of malfunction or damage, please contact your specialist dealer immediately. Do not perform any makeshift repairs or modifications. Repair work has to be carried out by authorised specialist workshops or by the manufacturer only. Non-adherence to this provision will render our guarantee invalid.
- Only raise or lower the lifting rod when the backrest is in an upright position and fully locked.
- Do not use height adapters for this product.
- Do not store the product in the vicinity of heat sources.

➤ **Please keep these operating instructions in a safe place!**

- Before transporting the bathlift please make sure that the hand control is disconnected.
- **If the lift has been exposed to low temperatures for a long period of time (e.g. prolonged storage in a vehicle during winter), allow it to warm up to room temperature before using it, so as to avoid damage.**
- When using bath oils or salts, please observe the recommended dosage – such additives may affect the gliding behaviour of the crossbar mechanism.
- **Do not use any acetic acid cleaners or detergents for cleaning the Bellavita !**

▮ **Notes concerning the battery, battery charger and hand control:**

- Use the hand control only to operate the bathlift.
- The bathlift must only be used with an original hand control made by Drive Medical.
- Never throw the hand control into an open fire or store it in the vicinity of fire or strong heat sources.
- Do not open the hand control. This will invalidate the guarantee.
- Use only the supplied battery charger to charge the battery.
- Do not use the hand control if the housing shows any signs of damage.
- Use the battery charger only in dry rooms outside of the bathroom. Use the charging unit only for charging the supplied storage battery.
- **It is vital that the battery be fully charged before the first use of the Bellavita - thereafter, it should be charged after each use.**

If the device is not used for long periods of time, the battery should be re-charged every 3 months in order to increase the longevity of the device.

- Do not insert any conductive objects (e.g. needles, metal pins, etc.) into the jack socket of the hand control.
- Always disconnect the mains plug from the socket before cleaning the battery charger.
- Clean the battery charger with a dry cloth only.
- The Bellavita, battery charger and battery, are built in a very robust way, but should not be dropped. If you should find any visible and/or audible signs of damage, do not use the bathlift and notify your specialist dealer immediately. We recommend entering the address of your nearest representative on the last page of these operating instructions.
- For further information, technical details and addresses, please read the complete operating instructions.
- In the event of a malfunction, please read our “Troubleshooting” Chapter in the Appendix to these operating instructions. Please observe the information and instructions given there. For your own safety, please do not use the bathlift until any defect or malfunction is remedied.

▮ **Important safety rules**

- Always sit down in the middle of the lift with your back against the backrest, with your legs stretched slightly forward and place your free hand either on the edge of the bath or on your lap. Use the other hand to operate the hand control to raise or lower the lift.
- Whilst raising or lowering the lift, do not place your hand between the bath edge and the lift or underneath the seat as this may cause injury.
- Persons with severe or mental disabilities must never be left unattended in the bath. Only take a bath without any help if your ability allows you to do so – otherwise, ask someone to assist you.
- Before using the bathlift a test run should be carried out to check for the correct raising, lowering and EMERGENCY STOP functions.
- If a malfunction has occurred, do not operate the bathlift and ask your specialist dealer to remedy the problem.
- Do not use any objects that could get stuck in the mechanism (e.g. brushes, etc.) whilst using the bathlift!

Notes concerning Electromagnetic Compatibility (EMC)

This product is compliant with the protection requirements set forth in the Council Directive for the Harmonization of Legal Stipulations of the Member States concerning Electromagnetic Compatibility (EMV, IEC 60601-1-2) (89/336/EWG). However, the occurrence of electrical interference cannot be ruled out completely under certain conditions, i.e. in particular, if mobile phones or other electrical devices are

used. In the vicinity of the bathlift, do not operate any life-preserving or life-supporting devices or any devices that may cause health hazards for users in the event of malfunction. Such devices may be subject to electrical interference under certain conditions, or they may adversely affect the proper functioning of the bathlift.

If you should detect any malfunctions or unusual behaviour with your bathlift or in the vicinity or during the operation of other electrical devices, please make the bathlift inoperative and notify your specialist dealer.

Installation and use

Unpacking

Please check the shipping carton for completeness – it should contain the following parts:

1. Drive unit with integrated backrest and hand control (with integrated battery)
2. Seat unit with side flaps
3. Battery charger
4. Operating Instructions
5. 4 x suction cups, 75 mm (2.95 in) diameter, for assembly on baseplate

If one of these parts should be missing or damaged, please inform your specialist dealer.

Unpack the charging unit first, then the remaining parts. The shipping carton may be kept for later use (i.e. transportation or storage of the bathlift).

Prior to using the device for the first time we recommend charging the storage battery. Please follow the information given in Chapter “Charging the Battery”.

First installation in the bath

1. Attach the suction cups to the underside of the seat unit (baseplate). The tongues of the rear suction cups must be directed outwards – this ensures better access when the lift has to be removed from the bath. Press the tongues of the front suction cups into the provided recesses (front) in the baseplate.

Important note:

The suction cups hold the bathlift firmly in place on the bottom of the bath. Therefore, the suction cups at the underside of the Bellavita must be **clean and dry**. The bath itself must also be clean and dry. We recommend cleaning the suction cups and bathtub regularly with commercial cleaning agents, so as to achieve highest possible suction.

2. Make sure that the bottom of the bath is empty and clean (remove anti-slip mats or similar, if necessary).
3. Place the seat unit with the suction cups attached to the baseplate into the empty bath. Make sure that the rear suction cups are located close to the bevelled edge of the bath.

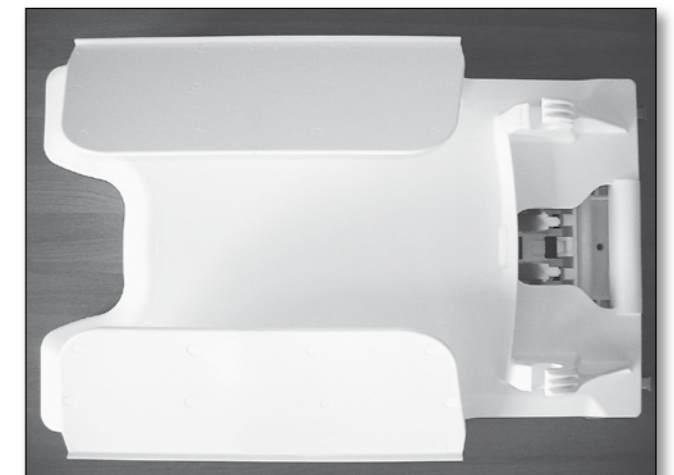

For more slip resistance are 2 additional suction cups available.

4. Now insert the drive unit with integrated backrest into the bearing blocks of the seat unit (see illustration).



5. Now hold the backrest at the hand grips and using the other hand tilt it backwards (see illustration) until the drive unit rests against the baseplate.



① Hand grip

➤ **Attention!** It is very important that both guide pins are inserted into the bearing blocks!

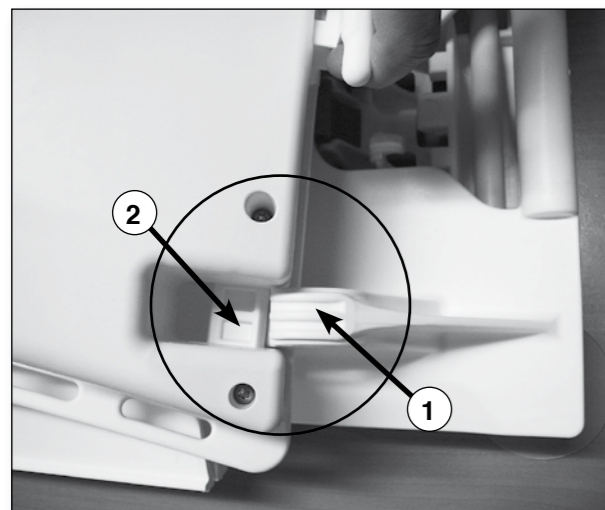

① Bearing block · ② Guide pin

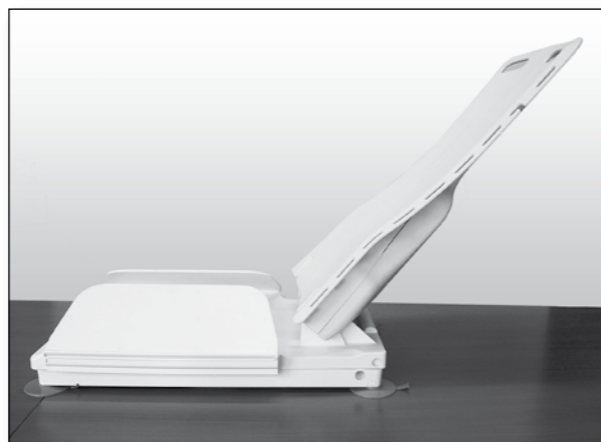

Please make sure that the red stop lever is in the correct position.

6. Connect the hand control to the bathlift. To do this, **plug the jack socket onto the jack plug until it catches in and the red ring at the jack is unseen.** The bathlift is now ready for movement.

➤ **Note:** If there is a risk of the backrest colliding with the back of the bath, reposition the base further away from the end of the bath.

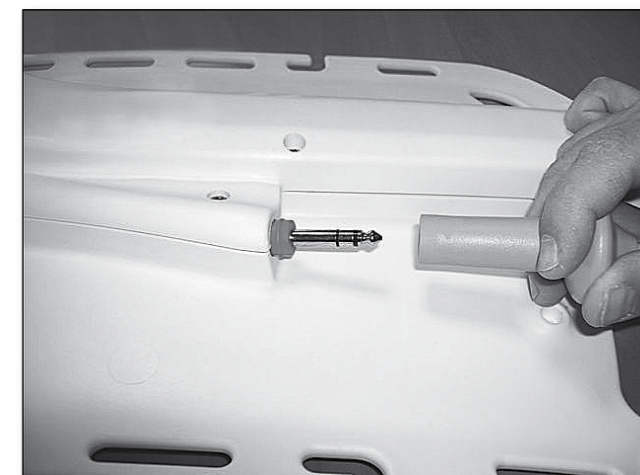

7. Make sure that the lifting rod is positioned correctly in the unlock ramp.

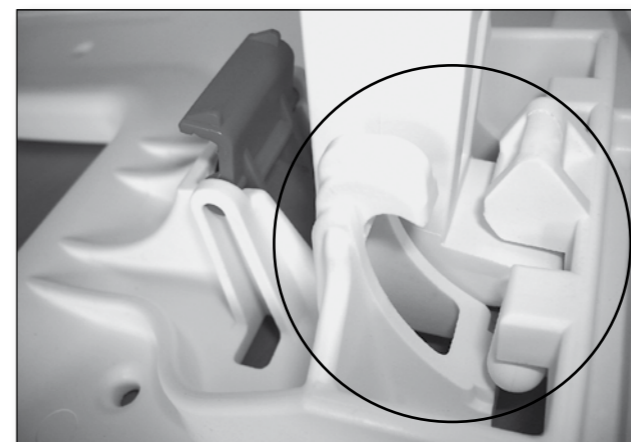

correct



incorrect

Attaching and removing the covers

The covers can be attached and removed very easily.

- To attach the cover, place it correctly on the surface of the backrest and press the fastening buttons completely into the holes provided in the backrest and seat (or seat and side flaps see illustration).



Backrest cover



Backrest cover



Seat cover (comfort cover shown)

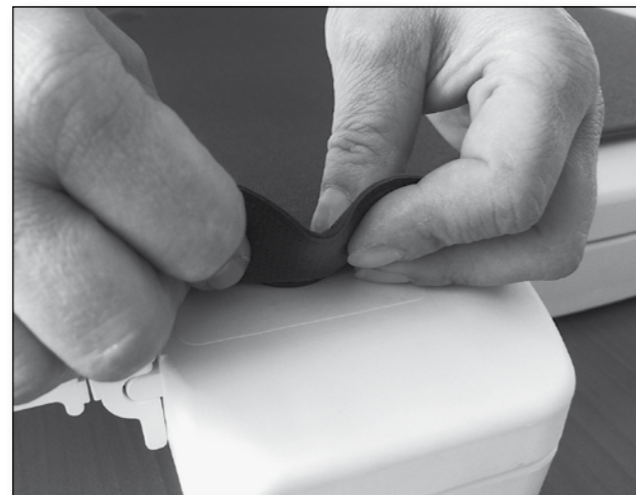

Seat cover

- To remove the covers, lift the two fastening buttons with two fingers; then pull them out.

The bathlift can also be used without covers.

Installing the headrest (optional)

Insert the two rods of the headrest into the openings at the top of the backrest plate. The headrest can be effortlessly adjusted to the desired height.

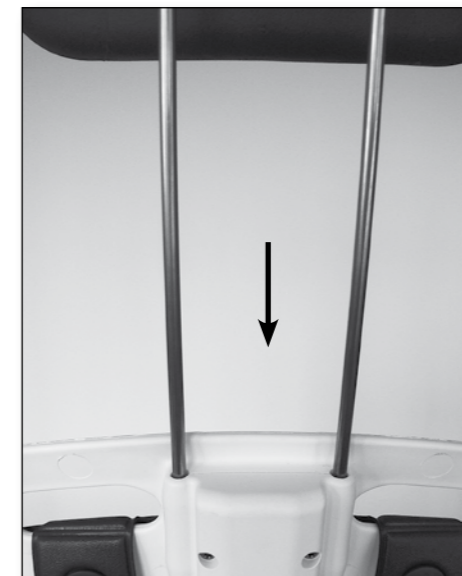
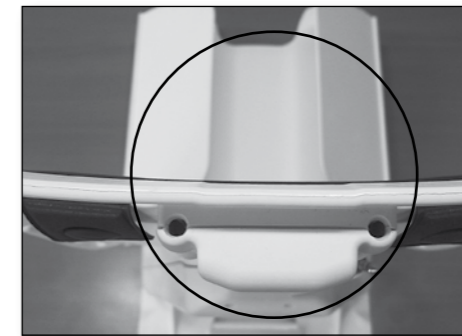

Hand control

Depending on the weight of the person bathing, the capacity of the fully charged battery is for a maximum of 6 baths. During the bathing process the green control lamp of the hand control is lit up green.

When the charging level of the battery falls to a factory-defined level, the lamp colour changes to orange and the lamps starts to blink slowly. This indicates that there is enough energy for 1 (one) bath and the battery **should** be charged according to the operating instructions.

If you continue to use the lift whilst the lamp is lit yellow, the lamp colour may change from yellow to red and start to flash at fast intervals. In this case, the lift will only move upwards to ensure that you can leave the bath safely. The battery **must** now be charged immediately using the battery charger supplied.

GREEN lamp: Lift is ready for operation.

ORANGE lamp: Limited readiness for operation – sufficient for one (1) more bath. The battery should be charged.

RED lamp: Lift no longer ready for operation – lift will only move upwards. Battery **must** be charged immediately.

• **EMERGENCY-OFF button (red):**

Should an emergency situation occur, all the functions of the bathlift must be brought to a standstill by pressing the red EMERGENCY OFF button. To re-activate the bathlift, press the green ON button once again.

The bathlift switches off automatically after approx. 30 minutes. If you wish to switch it off manually, please press the red button on the hand control (the control lamp will go out).

- ① Down button (blue)
- ② EMERGENCY-Off button (red)
- ③ Control lamp (LED)
- ④ Up button (yellow)
- ⑤ On button (green)

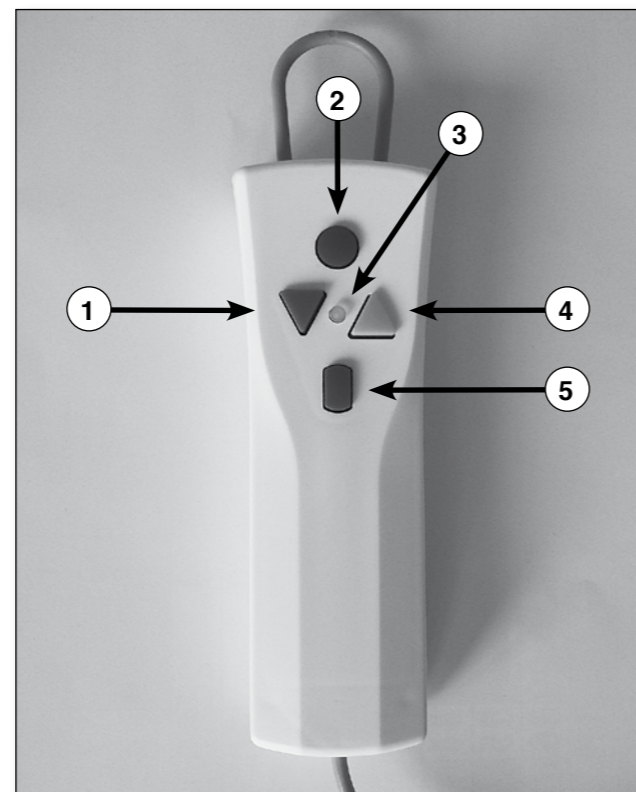

Operating the Bellavita in the bath

1. Before using your bathlift, make sure that the hand control is connected properly via the plug-type connection on the bathlift. The red ring at the jack is now unseen. Press the ON button (green) on the hand control. The green control lamp is illuminated.

2. Now press the UP button (yellow). The backrest moves to an upright position first; then the lift rises to its end position and switches off automatically. The lift can be raised to any height in between, by releasing the button once the required height is achieved.

3. Fold out the side flaps until they rest on the sides of the bath. Raise the seat until the seat surface is at the same level as the upper edges of the bath and the side flaps are in a horizontal position.

➤ **Important: The side flaps must rest flat on the side surfaces of the bathtub.**

4. Sit down on bathlift. If this is not possible without help, ask for assistance.

5. To lower bathlift, press the Down button (blue). The lift lowers until it reaches its end position, then the backrest is tilted back automatically. The drive switches off automatically in the end position. However, the backrest can be reclined to an angle in between by simply releasing the button once the required angle has been achieved.

➤ **Attention! If the backrest pushes against the wall of the bath release the blue button immediately!**

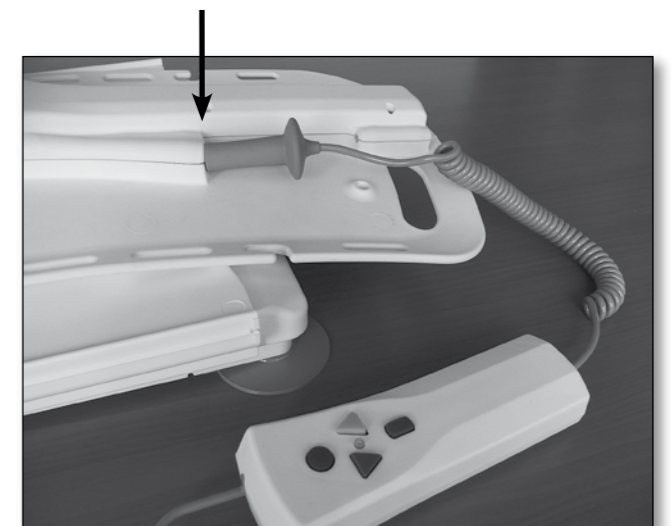
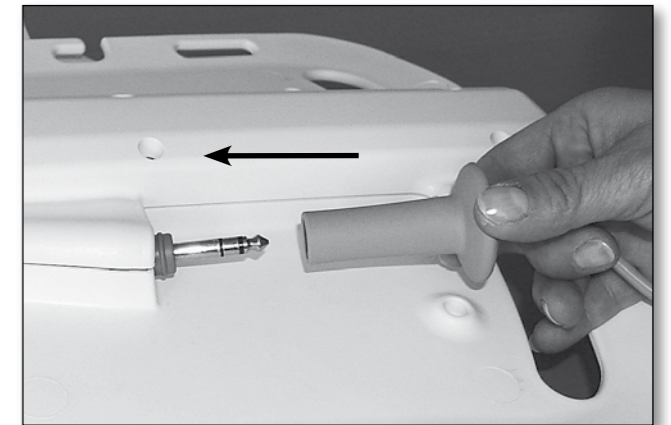

6. After bathing, press the UP button (yellow) on the hand control to move the lift to a convenient height (max. upper stop position).

Make sure that the side flaps do not get caught on bath fittings or handles.

7. Now the person bathing can leave the bath by sliding sideways from the seat surface.

The Bellavita switches off automatically after approx. 30 minutes. If you wish to switch off the bathlift manually, press red button on the hand control (the control lamp will go out).

➤ **Notes:**

When moving up or down, lean against the backrest and leave your hands on your lap.

If the lift has to remain in the bath, the hand control should be disconnected to prevent the battery from discharging.

🔧 **Removing the lift from the bath**

Using the hand control, first move the bathlift to its bottom position and allow the backrest to tilt back until the drive stops automatically in its end position. Take note that the backrest does not touch the wall of the bathtub. Now disconnect the hand control.

1. Fold in the side flaps, so that they rest on the seat surface.
2. Use the handles of the drive unit to fold the drive unit down.



3. Make absolutely sure that the lifting rod is always retracted completely.



correct



incorrect

4. Now the drive unit can be removed from the seat unit in the direction of the arrow (see illustration).

➤ **Note: The drive unit can only be removed at a specific angle. When it is completely folded down and locked, it can not be removed from the seat unit. Bring the backrest into the position shown in our illustration; then remove the drive unit in the direction of the arrow.**

5. Remove the two rear suction cups by pulling the tongues. Then lift off the rear part of the baseplate. This action will loosen the front suction cups, which are self-venting. The seat unit can now be removed from the bathtub.



Maintenance of the bathlift

The Bellavita is equipped with maintenance-free bearings and does not need any lubrication.

A periodic maintenance check of the bathlift has to be conducted at least every 12 months. This check includes a visual inspection of all parts in particular load-bearing parts. It also includes all the necessary function tests. If the inspection reveals any defects, wear or other signs of damage, which might affect the safety of the bathlift, the bathlift has to be made inoperative until the defects are remedied. All inspections have to be carried out by qualified and trained personnel who have sufficient skills and practical experience to perform such safety-relevant work in an appropriate manner. These qualified personnel have to remain independent with regard to the tests and inspections being carried out.

Please ask your bathlift specialist to arrange for periodic inspections.

Your bathlift specialist has the necessary spare parts lists and documentation available for you.

Please have repair work carried out by authorised specialist dealers only.

➤ **Attention: The hand control must only be opened by the bathlift manufacturer!**

Cleaning

To keep the bathlift in a perfect condition it must be cleaned immediately after use (preferably by showering it with hot water).

Carefully clean the bathlift under the shower after each use.

To clean the bathlift (without covers), please use commercial disinfectants or bath cleansers.

Maintenance of seat covers

The material of the removable covers is very hygienic due to its smooth surface and antibacterial properties.

The maintenance of the covers requires regular cleaning, either by hand or in the washing machine at 60°C (140°F). Please use a non-bio detergent without any enzyme additives. Please note that bath oils or other additives containing oils may lead to discoloration of the covers.

Discoloration can also occur if the covers are not cleaned regularly.

➤ **Note: Discolorations of the covers are caused by normal wear and are excluded from the warranty.**

- The covers can be removed very easily for cleaning.
- **Do not dry the covers in the tumble dryer,** but hang them on a line to dry.
- In addition, the use of a commercial disinfectant is recommended.
- Please observe the manufacturer's instructions!

Assembly of new cushion plugs for the bathlift covers

First guide the new cushion plug through the opening in the cushion (from top to bottom); then press it into the washer at the underside.

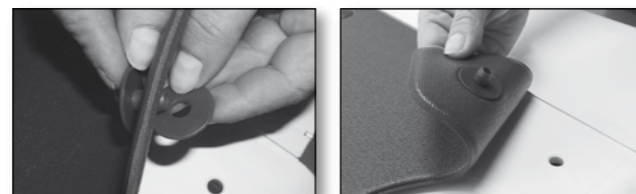

Maintenance of the battery charger

The charging unit does not require any maintenance. The housing must only be cleaned with mild detergents that are free from solvents, or by means of a damp cloth. Make sure that no liquid enters into the charging unit. Before using the charging unit again, always make sure that the unit is completely dry. If necessary, store the unit in a dry, ventilated place for several hours without connecting it to mains power.

➤ **Attention:**

Before cleaning the battery charger it must be completely disconnected from the mains power (always make sure to pull the mains power plug).

Charging the storage battery

Make sure that the battery is fully charged before use! The voltage rating on the charging unit has to be compatible with the voltage of your power supply. (e.g. 220V – 240V in Europe, and 110V in USA).

1. Plug the jack plug of the battery charger into the socket on the spiral cord of the hand control until the jack plug is locked in.
2. Insert the mains plug of the battery charger into a socket. The red control lamp on the hand control will be light up until the battery is charged – after that, it will change to green. If you want to charge the battery completely, leave it connected to the charging unit. The control unit of the battery charger will terminate the charging process after approx. 4 hours. This prevents that the battery from being over-charged.
3. Remove the mains power plug from the socket.
4. Remove the jack plug of the battery charger from the socket on the hand control.



➤ **Important information:**

- If the control lamp is not lit up after connecting the hand control, please check the following:
 - **Connections** (is the jack plug fully plugged into the charging socket?)
- Use the battery charger only in closed rooms and protect it against water and humidity. **Do not use the battery charger in the bathroom.**

➤ **Note:**

- **If the battery charger is damaged, please return it to the supplier for inspection.**

Please observe the following instructions for **mobile use**:

1. Remove the hand control from the bathlift and transport separately.

2. Always protect the bathlift against sliding or slipping during the transportation (e.g. in a car).

3. If the battery is subjected to low temperatures (e.g. storage in a car in the winter), always allow the battery to warm up to room temperature and charge as necessary.

4. When lifting the units, please note that the seat unit weighs approx. 5.5 kg (12.1 lb) and the drive unit (without hand control) weighs approx. 3.8 kg (8.37 lb).

Transport as two separate units

The seat and drive units can be transported easily with two hand grips.



Transport in an interlocked condition

The bathlift can also be transported as a complete unit in an interlocked condition.



Technical Data Bellavita bathlift

Overall length (with backrest in a reclined position)	approx. 830 mm (32.7 in)
Overall width (seat incl. side flaps)	approx. 700 mm (27.6 in)
Width of seat	approx. 350 mm (13.8 in)
Depth of seat	approx. 420 mm (16.5 in)
Overall length of seat	approx. 570 mm (22.4 in)
Sitting height min.	approx. 60 mm (2.4 in)
Sitting height max.	approx. 480 mm (18.9 in)
Height of backrest	approx. 640 mm (25.2 in)
Width of backrest	approx. 320 – 360 mm (12.5 – 14.2 in)
Backrest adjustment	10° – max. 50°
Width of baseplate	approx. 310 mm (12.2 in)
Length of baseplate	approx. 560 mm (22.1 in)
Load capacity max.	140 kg
Total weight (excl. hand control)	approx. 9,3 kg (20.5 lb)
Total weight (incl. hand control)	approx. 9,7 kg (21.4 lb)
Weight of hand control incl. battery	approx. 0,4 kg (0.88 lb)
Weight of drive unit	approx. 3,8 kg (8.37 lb)
Weight of seat unit	approx. 5,5 kg (12.1 lb)
Duration of lifting/lowering movement, each	approx. 50 seconds under load
Operating voltage	12 V
Storage battery (lithium-ion)	12 V / 1,3 Ah re-chargeable (see designation on housing)
Automatic shutdown	max. 30 minutes
Power input	90 W max. 12 V
Type of application part (B)	
Protection class	IP X7
Power to push the button off the hand control	3 N

General Operating Conditions

- Ambient conditions for operation:

Temperature	+ 10° C + 50° C	(+ 50° F..... + 122° F)
Relative air humidity	10..... 100%	
Air pressure	700 hPa 1060 hPa	
- Ambient conditions for transport and storage:

Temperature	- 10° C + 40° C	(- 50° F.....+ 104° F)
Relative air humidity	10..... 100%	
Air pressure	700 hPa 1060 hPa	
- Sound pressure level 54 dB A

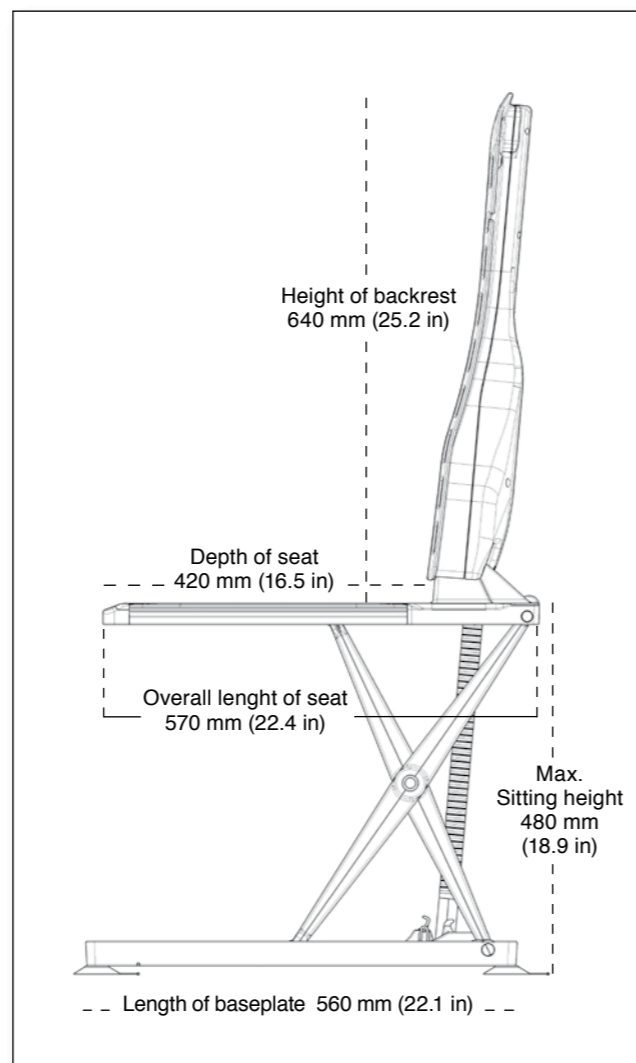
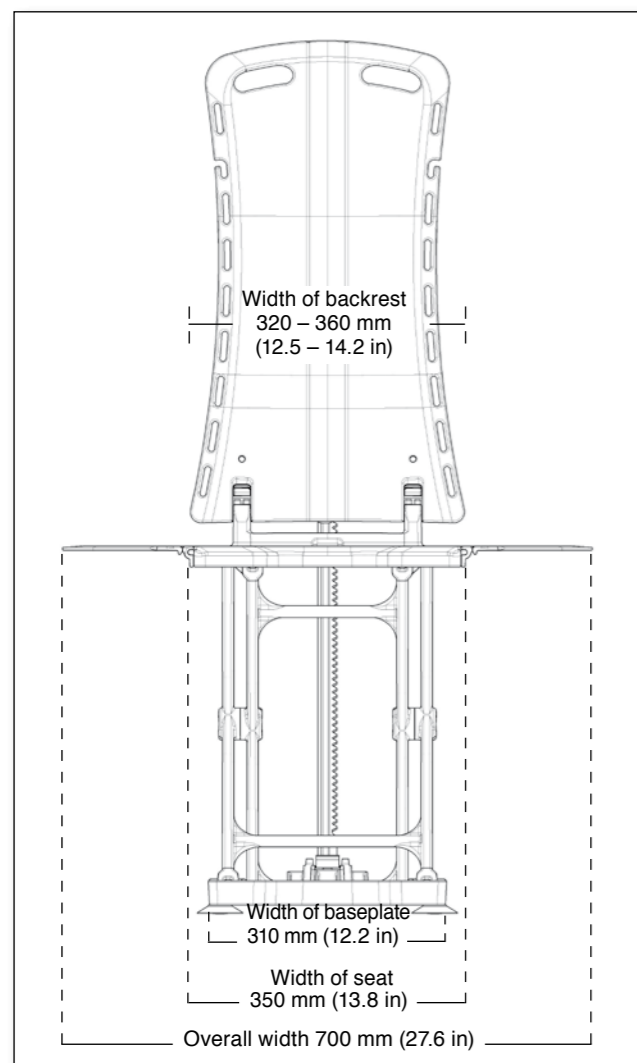
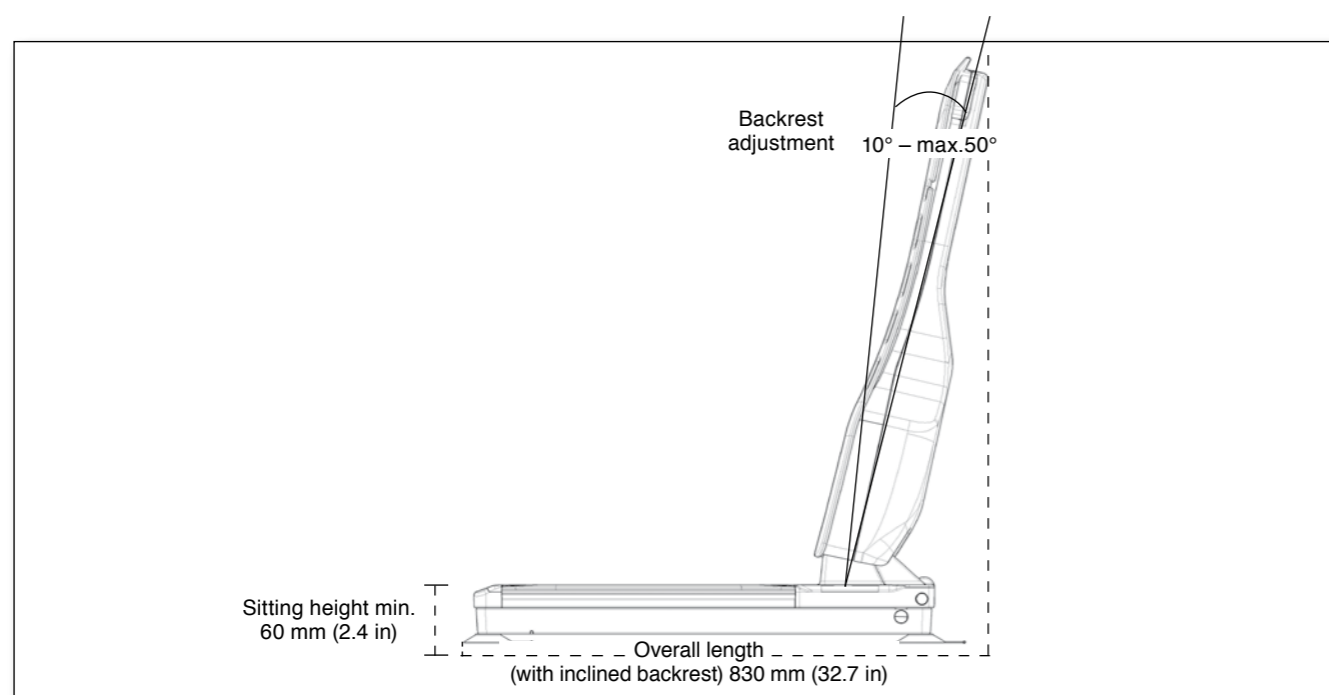

Troubleshooting

Error	Possible cause	Remedy
<i>Lift does not move</i>	<ul style="list-style-type: none"> • Battery is flat • Contacts on hand control are contaminated • Hand control is not connected properly 	<ul style="list-style-type: none"> – Charge battery – Unplug hand control; wipe contacts with a dry cloth and plug hand control in again – Check plug-type connections
<i>Lift stops repeatedly</i>	<ul style="list-style-type: none"> • Battery is flat • Excessive lifting load • Jack plug not fully plugged 	<ul style="list-style-type: none"> – Charge battery – Reduce lifting load (note max. load ratings, see type label on the bathlift) – check jack plug connection
<i>Battery does not charge</i>	<ul style="list-style-type: none"> • Not connected to mains power • Contaminated contacts 	<ul style="list-style-type: none"> – Connect battery charger to mains power – Wipe contacts with dry cloth
<i>Hand control does not function correctly</i>	<ul style="list-style-type: none"> • Jack plug not plugged in fully 	<ul style="list-style-type: none"> – Ensure jack plug is fully plugged in

Important remark concerning troubleshooting:

If it is not possible to operate the bathlift despite observing all of the above-mentioned information, please contact the specialist dealer who sold the device.

Notes concerning the disposal

The disposal and re-utilisation of old devices and equipment has to be in compliance with the relevant legal stipulations.

Devices subject to the Regulations concerning electrical and electronic devices (elektroG) are listed as medical products for professional users B2B in the register of the foundation "elektro-Altgeräte-Register".

Our registration number is DE 33275322

Re-use/Recycling

This product is suitable for re-use. The number of re-uses depends on the condition of the product. The manufacturer's instructions have to be followed for re-cycling. If necessary, these instructions will be made available on request.

Warranty

Our warranty for the Bellavita bathlift will be in accordance with legal stipulations and/or regulations valid in the different countries. The warranty applies to Commercial and Domestic applications, subject to the conditions stated here. In the event of any part/product developing a manufacturing fault or design fault within the warranty period, replacement parts will be supplied free of charge. In all instances the warranty is provided to the first time purchaser or user only. The warranty is not transferable to another user, howsoever the product is passed on or sold.

To qualify for our warranty

1. The customer must present an original invoice, delivery note or date stamp of the authorized dealer.
2. In the case of the **Domestic user**, an accredited and certified Agent, who has been appropriately trained or approved by the Manufacturer, must service the bathlift at least once every 12 months.
 - a. Proof of service in the form of an invoice or service certificate will also be required.
 - b. Lifetime guarantee on frame and motor. 2 years on handset (battery, charger and parts). One year on covers and suckers excluding wear and tear damage. Guarantee subject to normal use in accordance with user manual and does not cover user negligence, user error or accidental damage.
 - c. The guarantee applies to the first time user only and is non transferable.

3. In the case of the **Commercial user**, an accredited and certified Agent, who has been appropriately trained or approved by the manufacturer, must service the bathlift at least once every 12 months. Any additional Health & Safety regulatory checks that may be in force from time to time must also be complied with.

- a. Proof of service in the form of an invoice or service certificate will also be required or appropriate documentation and records.
- b. 3 years guarantee on frame and motor. 2 years on handset (battery, charger and parts). One year on covers and suckers excluding wear and tear damage. Guarantee subject to normal use in accordance with user manual and does not cover user negligence or user error.

Damage due to natural wear or improper treatment is not covered by our warranty. Damage caused by defective material or manufacturing errors will be remedied by replacement parts supplied free-of-charge. Our warranty will be become invalid if the device is changed or manipulated by unauthorized persons or in an unauthorized manner.

Any further claims are excluded, unless there are any binding national rules and regulations. We cannot be held liable for any direct or indirect defects or damages resulting from defects, or any losses or costs in connection with the use or inability to use the device for any purpose. Tacit agreements regarding the use or suitability for a specific purpose are explicitly excluded.

Accessories and spare parts

The list below shows the order numbers (part numbers) for original accessories and original spare parts supplied by Drive Medical:

Article	Order Number
• Seat and backrest covers	
Cover-Set Classic, white	460800252
Cover-Set Classic, blue	460800312
Cover-Set Classic, grey	460800432
Cover-Set Comfort, white	460900252
Cover-Set Comfort, blue	460900312
Cover-Set Comfort, grey	460900432
• Spare parts	
Power supply EU, Bellavita	460900401
Power supply UK, Bellavita	460900402
Power Supply US, Bellavita	460900403
Plug + washer for Cover Classic & Comfort (1 ea.), white	415252
Plug + washer for Cover Classic & Comfort (1 ea.), blue	415312
Suction cup Ø 75 mm (2.95 in) with clip, grey	460900213
Set of suction cups 4 x Ø 75 mm (2.95 in) with clips, grey	460900220
Hand control including storage battery	460900600
• Accessories	
Headrest, padded, white	410200252
Headrest, padded, blue	410200312
Headrest, padded, grey	410200432
Turning and transfer aid, VITATURN L	412100200
Turning aid VITATURN K	412100100
Side flap protector, set of 2 ea.	400570



Headrest



Side flap protector

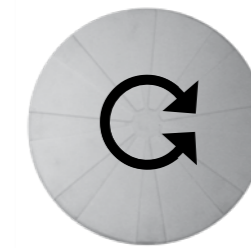

Vitatum K

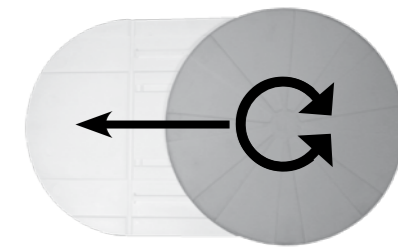

Vitatum L

Explanation of symbols

 CE-label. This product fulfils all the fundamental requirements of the EU Directive concerning Medical Products, 93/42/EWG

 Direct current

 Important note

 The bathlift cannot be disposed as an unsorted municipal solid waste, according to the EU Directive 2002/96/EU. Therefore, please dispose of the bathlift at your local collecting point.

Type labels

There are two product labels on the bathlift – on the seat unit and drive unit. The product label of the seat is provided underneath the seat; the product label of the drive unit is provided at the rear side. Next to the general technical remarks on the product label there are two entries, which are important for maintenance, repair and guarantee claims:

 (WW/YY) Week and year of manufacture of bathlift

SN Serial number of bathlift

 Type of application part (B)

Notes concerning these operating instructions

These instructions were produced with special care. We do not assume liability for the correctness of figures, graphs, technical data and electrical values or for typographical errors.

Any form of reproduction of these instructions requires our prior written permission.

Subject to technical changes, errors excepted.

Accessories and spare parts	23	Low temperatures	18
Addresses	28	Maintenance	16
Appendix	19	Maintenance of battery charger	17
Backrest	3, 8, 9, 15	Maintenance-free bearings	16
Bath	5, 13	Malfunction	5
Bathing of persons	5	Material separation	22
Bathing	13, 14	Mobile use	18
Battery charger	4, 17	ON button	13
Blue button	13	Operating instructions	24
Capacity (battery)	12	Product description	3
Charging (battery)	17	Physically handicapped people	5
Cleaning	16	Repairs	4
Cleaning agents	16	Red button	13
Covers	10	Removal from the bathtub	14
Disinfectants	16	Re-use/re-cycling	22
Disposal	22	Side flaps	10
Electromagnetic compatibility	5	Safety	4
End position, upper	13	Safety rules	5
End position, lower	13	Seat surface	3, 19
Explosion and fire hazard	5	Specialist dealer	5
Explanation of symbols	24	Storage	6
First Startup	6	Storing the lift in the car	18
First installation	7	Storing the battery	18
Green lamp	12	Suction cups	6, 7, 13, 15, 23
Guarantee claims	4	Technical Data	19
Hand grip	8	Transport	6, 18
Hand control	3, 8, 12	Troubleshooting	21
Headrest	11	Troubleshooting, important notes	21
Inserting into the bathtub	7	Turning and transfer aid	23
Installation	6, 7	Turning aid	23
Lamp slowly flashes yellow	12	Type labels	24
Lamp flashes red at short intervals	12	Unpacking	6
Lifting	5	Use	6
Lifting rod	4, 15	Warranty terms	22
Lubrication	16	Yellow lamp	12
Lowering bathlift	5, 13	Yellow button	13



Address

UK

Drive Medical Limited

Ainleys Industrial Estate, Elland, West Yorks,
HX5 9JP

Phone +44 (0) 1422 31 44 88

Fax +44 (0) 1422 31 44 89

Mail enquiries@drivemedical.co.uk

Web www.drivemedical.co.uk

Please enter the address
of your specialist dealer:

Art. No. 460900506 · As of: 09/2010

© 2008 by Drive Medical GmbH & Co. KG
