

Model 3200

Pool lift

Direct from wheelchair to pool



- Direct transfers to and from wheelchair to water.
- Easy to move and store the lift.
- Use one lift at multiple locations: multiple pools or several areas at same pool.
- Variety of accessories make transfers easy regardless of disability.
- Designed for the swimming pool environment.

Lift & Care systems for people with reduced mobility

www.handimove.com

Pool lift

DIRECT TRANSFERS TO AND FROM WHEELCHAIR TO WATER.

The Pool lift brings the user to the water in one smooth motion. This efficient lift moves the user to the pool in one transfer.

360° The Pool lift has a pivoting range of 360°.

EASY TO MOVE AND STORE THE LIFT.

Operation is simple, with the push of a button, the spindle lowers into the floor socket at the edge of the pool.

When finished, lift the spindle out of the socket, and wheel the lift to storage.

Once removed, seal the socket opening with the plug.

USE ONE LIFT AT MULTIPLE LOCATIONS: MULTIPLE POOLS OR SEVERAL AREAS AT SAME POOL.

The installation of additional floor sockets, and the fact that it is easily movable, allows the lift to be used in different locations

VARIETY OF ACCESSORIES MAKE TRANSFERS EASY REGARDLESS OF DISABILITY.

Customize the transfer with the right accessory.

Based on the need choose a pool lift chair, Handi-Move Body Support, bathing sling or standard sling.

DESIGNED FOR THE SWIMMING POOL ENVIRONMENT.

Made of stainless steel and powered by batteries, the mobile Pool lift is designed for safe, long-term use in the pool environment.



DISCRETE SOCKET,
WITH PLUG TO CAP SOCKET WHEN NOT IN USE



Pool lift

● DIMENSIONS AND SPECIFICATIONS

Dimensions (mm)		Specifications	
A	1840	Safe working load	135 kg
B	1305	Batteries	2 x 12 Vdc; 6,5 - 7,2 Ah
C	540	Charger	separate
D	350	Diameter of casters	100 mm
E	1700	Construction	stainless steel 316
F	550	Hand control	electrical (IP67)
G	500		
H	310		
I	370		

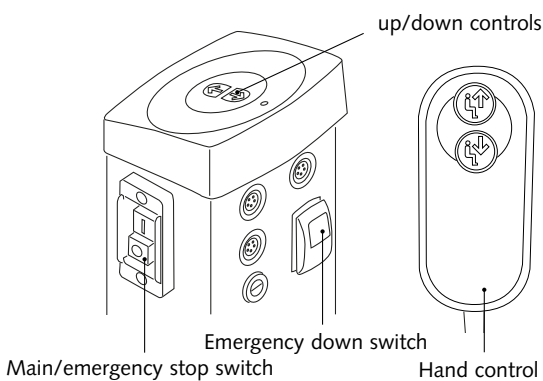
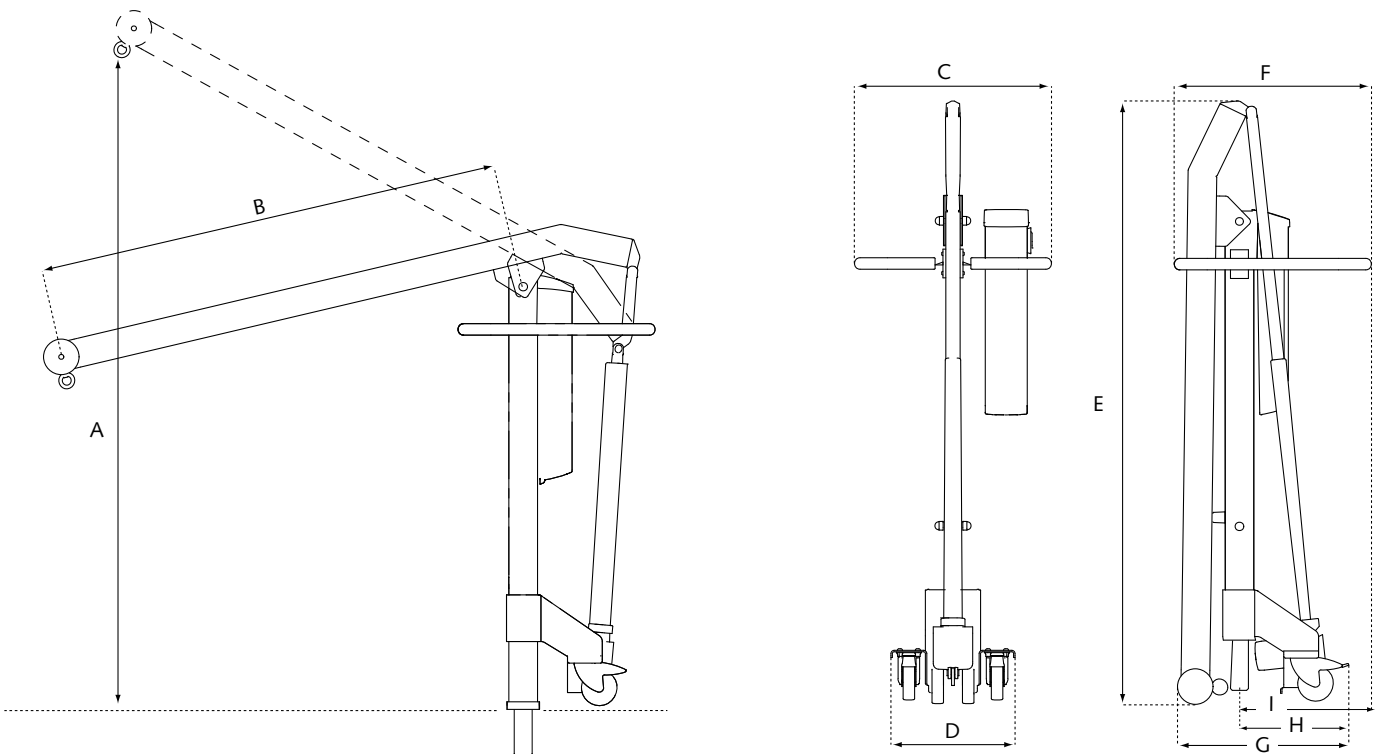

● BODY SUPPORT SYSTEMS

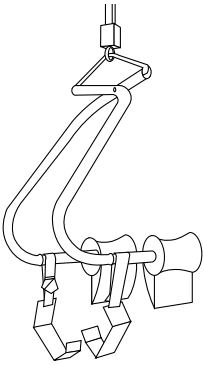

Body Support

XS - S - M • art. 1035
Electrolytically coated (anticorrosive)
+ Slipproof Thigh Supports • art. 1074

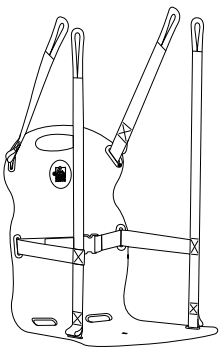
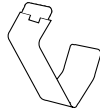

Pool Lift Chair (PVC)

Uni-size • art. 3620
+ Spreaderbar • art. 2110 / 2125

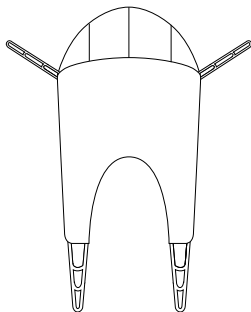
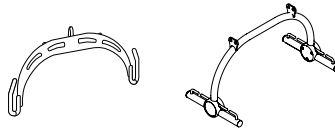

Standard Sling

with moon shaped head support and padded thigh flaps

XS - S - M - L - XL • art. 3431
+ Spreaderbar • art. 2110 / 2125

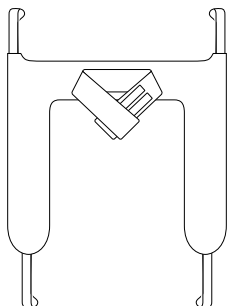
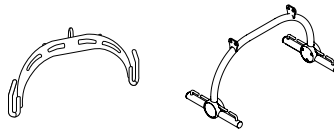

Bathing Sling (PVC)

XS - S - M - L - XL • art. 3464
+ Spreaderbar • art. 2110 / 2125

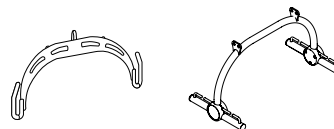

For free demonstration or further information

