



TPS 320i C

EN

Operating instructions

MIG/MAG power source



42,0426,0113,EN 033-14012021

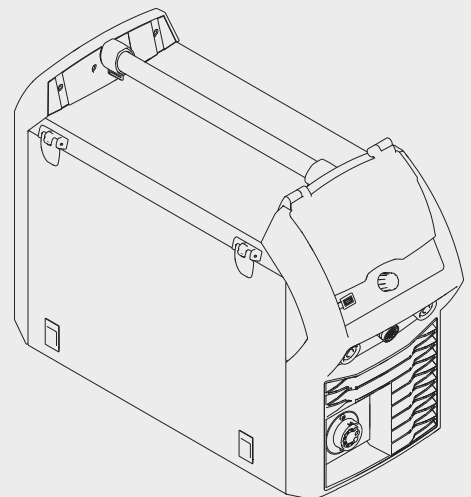

Contents

Safety rules.....	9
Explanation of safety notices.....	9
General.....	9
Proper use.....	9
Mains connection.....	10
Environmental conditions.....	10
Obligations of the operator.....	10
Obligations of personnel.....	11
Residual current protective device.....	11
Protecting yourself and others.....	11
Noise emission values.....	11
Danger from toxic gases and vapours.....	12
Danger from flying sparks.....	12
Risks from mains current and welding current.....	13
Meandering welding currents.....	14
EMC Device Classifications.....	14
EMC measures.....	14
EMF measures.....	15
Specific hazards.....	15
Requirement for the shielding gas.....	16
Danger from shielding gas cylinders.....	16
Danger from escaping shielding gas.....	17
Safety measures at the installation location and during transport.....	17
Safety measures in normal operation.....	17
Commissioning, maintenance and repair.....	18
Safety inspection.....	18
Disposal.....	19
Safety symbols.....	19
Data protection.....	19
Copyright.....	19
General information.....	21
General.....	23
Device concept.....	23
Functional principle.....	23
Application areas.....	23
Conformities.....	24
Bluetooth trademarks.....	25
Warning notices on the device.....	25
Description of the warning notices on the device.....	27
Welding packages, welding characteristics and welding processes.....	29
General.....	29
Welding packages.....	29
Welding characteristics.....	29
Summary of MIG/MAG pulse synergic welding.....	32
Summary of MIG/MAG standard synergic welding.....	32
Summary of the PMC process.....	32
Summary of the LSC process.....	32
Summary of SynchroPulse welding.....	32
Summary of the CMT process.....	32
Short description of the CMT Cycle Step welding process.....	33
System components.....	34
General.....	34
Overview.....	34
Options.....	35
Controls, connections and mechanical components.....	37
Control panel.....	39

General.....	39
Safety.....	39
Control panel.....	40
Connections, switches and mechanical components	42
TPS 320i C power source.....	42
Operating concept	45
Input options.....	47
General.....	47
Turning/pressing the adjusting dial.....	47
Pressing buttons.....	48
Pressing on the display.....	48
Display and status line.....	49
Display.....	49
Status bar.....	50
Status bar – Current limit reached.....	51
Installation and commissioning	53
Minimum equipment needed for welding task.....	55
General.....	55
MIG/MAG gas-cooled welding	55
MIG/MAG water-cooled welding	55
Manual CMT welding	55
TIG DC welding	55
MMA welding	55
Before installation and commissioning.....	56
Safety.....	56
Proper use.....	56
Setup regulations.....	56
Mains connection.....	56
Generator-powered operation.....	57
Information on system components.....	57
Connecting the mains cable.....	58
General.....	58
Stipulated mains cables.....	58
Safety.....	58
Connecting the mains cable - general.....	58
Commissioning the TPS 320i C.....	61
Safety.....	61
General.....	61
Recommendation for water-cooled applications.....	61
Connecting the gas cylinder.....	61
Establishing a ground earth connection.....	62
Connecting the welding torch.....	63
Inserting/replacing feed rollers.....	63
Inserting the wirespool.....	64
Inserting the basket-type spool.....	65
Feeding in the wire electrode.....	67
Setting the contact pressure.....	68
Adjusting the brake.....	68
Design of the brake.....	69
Performing R/L alignment.....	69
Locking and unlocking the power source using the NFC key.....	70
General remarks.....	70
Locking and unlocking the power source using the NFC key.....	70
Welding	73
MIG/MAG modes.....	75
General.....	75
Symbols and their explanations.....	75
2-step mode.....	76

4-step mode.....	76
Special 4-step mode.....	77
Special 2-step mode.....	77
Spot welding.....	78
MIG/MAG and CMT welding.....	79
Safety.....	79
MIG/MAG and CMT welding – overview.....	79
Switching on the power source.....	79
Setting the welding process and operating mode.....	80
Selecting the filler metal and shielding gas.....	81
Setting the welding parameters.....	82
Setting the shielding gas flow rate.....	83
MIG/MAG or CMT welding.....	83
MIG/MAG and CMT welding parameters.....	84
Welding parameters for MIG/MAG pulse synergic welding, for CMT welding and PMC welding.....	84
Welding parameters for MIG/MAG standard synergic welding and LSC welding.....	85
Welding parameters for MIG/MAG standard manual welding.....	86
Explanation of footnotes.....	86
EasyJob mode.....	87
General.....	87
Activating EasyJob mode.....	87
Storing EasyJob operating points.....	88
Retrieving EasyJob operating points.....	88
Deleting EasyJob operating points.....	89
Job mode.....	90
General.....	90
Storing settings as a job.....	90
Job welding - retrieving a job.....	91
Renaming a job.....	92
Deleting a job.....	93
Loading a job.....	94
Optimize job.....	95
Setting correction limits for a job.....	96
Pre-settings for "Save as Job".....	98
Spot welding.....	100
Spot welding.....	100
TIG welding.....	103
Safety.....	103
Preparations.....	103
TIG welding.....	104
Igniting the arc.....	106
Finishing welding.....	107
MMA welding.....	108
Safety.....	108
Preparations.....	108
MMA welding.....	109
Welding parameters for manual metal arc welding.....	112

Process parameters 113

Overview.....	115
Overview - Process parameters, Common.....	115
Overview – components and monitoring process parameters.....	115
Overview – Job process parameters.....	115
Process parameters, General.....	116
Process parameters for start of welding/end of welding.....	116
Process parameters for Gas-Setup.....	117
Process parameters for process control.....	118
Penetration stabilizer.....	118
Arc length stabilizer.....	120
Combination of penetration stabilizer and arc length stabilizer.....	122
Process parameters for SynchroPulse.....	123

Process parameters for Process mix.....	125
Process parameters for CMT Cycle Step	128
Process parameters for spot welding.....	129
R/L-check / alignment.....	129
Process parameters for TIG/MMA/SMAW setup.....	130
Components and monitoring process parameters.....	134
Process parameters for components.....	134
System adjust.....	135
Setting process parameters for arc break monitoring.....	137
Process parameters for wire stick contact tip.....	138
Process parameters for wire stick workpiece.....	140
Process parameter for wire end monitoring.....	141
Process parameters for gas monitoring.....	142
Motor force monitoring.....	144
Process parameters, Job.....	146
Optimising job process parameters.....	146
Process parameters for correction limits.....	148
Process parameters for pre-settings for "Save as Job".....	149
Defaults	153
Defaults.....	155
General remarks.....	155
Overview.....	155
Defaults - view.....	156
Setting the language.....	156
Setting Units/Standards.....	157
Setting the time and date.....	158
Retrieving system data.....	159
Displaying characteristics.....	162
Defaults - System.....	163
Retrieving device information.....	163
Restoring factory settings.....	163
Restoring the website password.....	164
Mode Setup: Setting the special 4-step mode "Guntrigger", special display for JobMaster, spot welding and torch trigger job selection.....	165
Setting network parameters manually.....	167
Setting up the WLAN.....	168
Bluetooth setup.....	169
Power source configurations.....	171
Wire feeder setup.....	172
Interface setup.....	173
Defaults - Documentation.....	176
Setting the sampling rate.....	176
Viewing the logbook.....	177
Activate/deactivate limit value monitoring.....	178
Defaults - Administration.....	180
General remarks.....	180
Explanation of terms used.....	180
Pre-defined roles and users.....	180
Overview.....	181
Administrator and creating roles.....	182
Recommendation for creating roles and users.....	182
Create administrator key.....	183
Creating roles.....	184
Copy roles.....	186
Creating a user.....	187
Creating a user.....	187
Copying users.....	188
Editing roles / users, deactivating user management.....	190
Editing roles.....	190
Deleting roles.....	191

Editing users	192
Deleting users.....	193
Deactivating user management	194
Lost NFC administrator key?.....	195
CENTRUM - Central User Management.....	196
Activating the CENTRUM server	196

SmartManager - The power source website 197

SmartManager - The power source website.....	199
General remarks.....	199
Opening and logging into the power source SmartManager.....	199
Help function, should you be unable to log in.....	200
Changing password / logging off.....	200
Settings.....	201
Language selection.....	201
Status indicator.....	202
Fronius.....	202
Current system data.....	203
Current system data.....	203
Documentation, logbook.....	204
Documentation.....	204
Job-Data.....	206
Job data.....	206
Job overview.....	206
Editing a job.....	206
Importing a job.....	207
Exporting a job.....	207
Exporting job(s) as.....	207
Power source settings.....	208
Process parameters.....	208
Name & location.....	208
MQTT settings.....	208
OPC UA settings.....	208
Backup & Restore.....	209
General remarks.....	209
Backup & Restore.....	209
Automatic backup.....	210
Signal visualisation.....	211
Signal visualisation.....	211
User management.....	212
General.....	212
Users.....	212
User roles.....	212
Export & import.....	213
CENTRUM.....	213
Overview.....	214
Overview.....	214
Expand all groups / Reduce all groups.....	214
Save as XML-file.....	214
Update.....	215
Update.....	215
Searching for an update file (performing the update).....	215
Fronius WeldConnect.....	217
Function Packages.....	218
Function Packages.....	218
Welding Packages.....	218
Special characteristics.....	218
Options.....	218
Installing a function package.....	218
Synergic lines overview.....	219
Characteristics overview.....	219

Showing/hiding the filter.....	219
Screenshot.....	220
Screenshot.....	220
Interface.....	221
Interface.....	221
Troubleshooting and maintenance	223
Troubleshooting.....	225
General.....	225
Safety.....	225
MIG/MAG welding – Current limit.....	225
Power source - troubleshooting.....	226
Care, maintenance and disposal.....	230
General.....	230
Safety.....	230
At every start-up.....	230
Every 2 months.....	230
Every 6 months.....	230
Updating firmware.....	230
Disposal.....	231
Appendix	233
Average consumption values during welding.....	235
Average wire electrode consumption during MIG/MAG welding.....	235
Average shielding gas consumption during MIG/MAG welding.....	235
Average shielding gas consumption during TIG welding.....	235
Technical data.....	236
Explanation of the term "duty cycle".....	236
Special voltages.....	236
Overview with critical raw materials, year of production of the device.....	236
TPS 320i C.....	238
TPS 320i C /nc.....	240
TPS 320i C /S/nc.....	242
TPS 320i C /MV/nc.....	244
Radio parameters.....	246

Safety rules

Explanation of safety notices

DANGER!

Indicates **immediate danger**.

- ▶ If not avoided, death or serious injury will result.

WARNING!

Indicates a **potentially hazardous situation**.

- ▶ If not avoided, death or serious injury may result.

CAUTION!

Indicates a **situation where damage or injury could occur**.

- ▶ If not avoided, minor injury and/or damage to property may result.

NOTE!

Indicates a **risk of flawed results and possible damage to the equipment**.

General

The device is manufactured using state-of-the-art technology and according to recognised safety standards. If used incorrectly or misused, however, it can cause:

- injury or death to the operator or a third party,
- damage to the device and other material assets belonging to the operating company,
- inefficient operation of the device.

All persons involved in commissioning, operating, maintaining and servicing the device must:

- be suitably qualified,
- have sufficient knowledge of welding and
- read and follow these operating instructions carefully.

The operating instructions must always be at hand wherever the device is being used. In addition to the operating instructions, attention must also be paid to any generally applicable and local regulations regarding accident prevention and environmental protection.

All safety and danger notices on the device

- must be in a legible state,
- must not be damaged,
- must not be removed,
- must not be covered, pasted or painted over.

For the location of the safety and danger notices on the device, refer to the section headed "General" in the operating instructions for the device.

Before switching on the device, rectify any faults that could compromise safety.

This is for your personal safety!

Proper use

The device is to be used exclusively for its intended purpose.

The device is intended solely for the welding processes specified on the rating plate. Any use above and beyond this purpose is deemed improper. The manufacturer shall not be held liable for any damage arising from such usage.

Proper use includes:

- carefully reading and following all the instructions given in the operating instructions
 - studying and obeying all safety and danger notices carefully
 - performing all stipulated inspection and maintenance work.
-

Never use the device for the following purposes:

- Thawing out pipes
 - Charging batteries
 - Starting engines
-

The device is designed for use in industry and the workshop. The manufacturer accepts no responsibility for any damage caused through use in a domestic setting.

The manufacturer likewise accepts no liability for inadequate or incorrect results.

Mains connection Devices with a higher rating may affect the energy quality of the mains due to their current consumption.

This may affect a number device types in terms of:

- Connection restrictions
- Criteria with regard to the maximum permissible mains impedance ^{*)}
- Criteria with regard to the minimum short-circuit power requirement ^{*)}

^{*)} at the interface with the public grid
see "Technical data"

In this case, the plant operator or the person using the device should check whether the device may be connected, where appropriate by discussing the matter with the power supply company.

IMPORTANT! Ensure that the mains connection is earthed properly

Environmental conditions Operation or storage of the device outside the stipulated area will be deemed as not in accordance with the intended purpose. The manufacturer shall not be held liable for any damage arising from such usage.

Ambient temperature range:

- during operation: -10 °C to + 40 °C (14 °F to 104 °F)
 - during transport and storage: -20 °C to +55 °C (-4 °F to 131 °F)
-

Relative humidity:

- up to 50% at 40 °C (104 °F)
 - up to 90% at 20 °C (68 °F)
-

The surrounding air must be free from dust, acids, corrosive gases or substances, etc.
Can be used at altitudes of up to 2000 m (6561 ft. 8.16 in.)

Obligations of the operator The operator must only allow persons to work with the device who:

- are familiar with the fundamental instructions regarding safety at work and accident prevention and have been instructed in how to use the device
- have read and understood these operating instructions, especially the section "safety rules", and have confirmed as much with their signatures
- are trained to produce the required results.

Checks must be carried out at regular intervals to ensure that operators are working in a safety-conscious manner.

Obligations of personnel

Before using the device, all persons instructed to do so undertake:

- to observe the basic instructions regarding safety at work and accident prevention
- to read these operating instructions, especially the "Safety rules" section and sign to confirm that they have understood them and will follow them.

Before leaving the workplace, ensure that people or property cannot come to any harm in your absence.

Residual current protective device

Local regulations and national guidelines may require a residual current protective device when connecting equipment to the public grid.

The type of residual current protective device recommended by the manufacturer for the equipment is indicated in the technical data.

Protecting yourself and others

Anyone working with the device exposes themselves to numerous risks, e.g.

- flying sparks and hot pieces of metal
- Arc radiation, which can damage eyes and skin
- Hazardous electromagnetic fields, which can endanger the lives of those using cardiac pacemakers
- Risk of electrocution from mains current and welding current
- Greater noise pollution
- Harmful welding fumes and gases

Suitable protective clothing must be worn when working with the device. The protective clothing must have the following properties:

- Flame-resistant
- Insulating and dry
- Covers the whole body, is undamaged and in good condition
- Safety helmet
- Trousers with no turn-ups

Protective clothing refers to a variety of different items. Operators should:

- Protect eyes and face from UV rays, heat and sparks using a protective visor and regulation filter
- Wear regulation protective goggles with side protection behind the protective visor
- Wear stout footwear that provides insulation even in wet conditions
- Protect the hands with suitable gloves (electrically insulated and providing protection against heat)
- Wear ear protection to reduce the harmful effects of noise and to prevent injury

Keep all persons, especially children, out of the working area while any devices are in operation or welding is in progress. If, however, there are people in the vicinity:

- Make them aware of all the dangers (risk of dazzling by the arc, injury from flying sparks, harmful welding fumes, noise, possible risks from mains current and welding current, etc.)
 - Provide suitable protective equipment
 - Alternatively, erect suitable safety screens/curtains.
-

Noise emission values

The device generates a maximum sound power level of <80 dB(A) (ref. 1pW) when idling and in the cooling phase following operation at the maximum permissible operating point under maximum rated load conditions according to EN 60974-1.

It is not possible to provide a workplace-related emission value during welding (or cutting) as this is influenced by both the process and the environment. All manner of different welding parameters come into play, including the welding process (MIG/MAG, TIG welding), the type of power selected (DC or AC), the power range, the type of weld metal, the resonance characteristics of the workpiece, the workplace environment, etc.

Danger from toxic gases and vapours

The fumes produced during welding contain harmful gases and vapours.

Welding fumes contain substances that cause cancer, as stated in Monograph 118 of the International Agency for Research on Cancer.

Use at-source extraction and a room extraction system.
If necessary, use a welding torch with an integrated extraction device.

Keep your face away from welding fumes and gases.

Fumes and hazardous gases

- must not be breathed in
- must be extracted from the working area using appropriate methods.

Ensure an adequate supply of fresh air. Ensure that there is a ventilation rate of at least 20 m³ per hour at all times.

Otherwise, a welding helmet with an air supply must be worn.

If there is any doubt about whether the extraction capacity is sufficient, the measured toxic emission values should be compared with the permissible limit values.

The following components are responsible, amongst other things, for the degree of toxicity of welding fumes:

- Metals used for the workpiece
- Electrodes
- Coatings
- Cleaners, degreasers, etc.
- Welding process used

The relevant material safety data sheets and manufacturer's specifications for the listed components should therefore be studied carefully.

Recommendations for trade fair scenarios, risk management measures and for identifying working conditions can be found on the European Welding Association website under Health & Safety (<https://european-welding.org>).

Flammable vapours (e.g. solvent fumes) should be kept away from the arc's radiation area.

Close the shielding gas cylinder valve or main gas supply if no welding is taking place.

Danger from flying sparks

Flying sparks may cause fires or explosions.

Never weld close to flammable materials.

Flammable materials must be at least 11 metres (36 ft. 1.07 in.) away from the arc, or alternatively covered with an approved cover.

A suitable, tested fire extinguisher must be available and ready for use.

Sparks and pieces of hot metal may also get into adjacent areas through small gaps or openings. Take appropriate precautions to prevent any danger of injury or fire.

Welding must not be performed in areas that are subject to fire or explosion or near sealed tanks, vessels or pipes unless these have been prepared in accordance with the relevant national and international standards.

Do not carry out welding on containers that are being or have been used to store gases, propellants, mineral oils or similar products. Residues pose an explosive hazard.

Risks from mains current and welding current

An electric shock is potentially life threatening and can be fatal.

Do not touch live parts either inside or outside the device.

During MIG/MAG welding and TIG welding, the welding wire, the wirespool, the feed rollers and all pieces of metal that are in contact with the welding wire are live.

Always set the wirefeeder up on a sufficiently insulated surface or use a suitable, insulated wirefeeder holder.

Make sure that you and others are protected with an adequately insulated, dry base or cover for the earth or ground potential. This base or cover must extend over the entire area between the body and the earth or ground potential.

All cables and leads must be secured, undamaged, insulated and adequately dimensioned. Replace loose connections and scorched, damaged, or inadequately dimensioned cables and leads immediately.

Use the handle to ensure the power connections are tight before every use.

In the case of power cables with a bayonet connector, rotate the power cable around the longitudinal axis by at least 180° and pretension.

Do not wrap cables or leads around the body or parts of the body.

The electrode (rod electrode, tungsten electrode, welding wire, etc.) must

- never be immersed in liquid for cooling
- Never touch the electrode when the power source is switched on.

Double the open circuit voltage of a power source can occur between the welding electrodes of two power sources. Touching the potentials of both electrodes at the same time may be fatal under certain circumstances.

Arrange for the mains cable to be checked regularly by a qualified electrician to ensure the ground conductor is functioning properly.

Protection class I devices require a mains supply with ground conductor and a connector system with ground conductor contact for proper operation.

Operation of the device on a mains supply without ground conductor and on a socket without ground conductor contact is only permitted if all national regulations for protective separation are observed.

Otherwise, this is considered gross negligence. The manufacturer shall not be held liable for any damage arising from such usage.

If necessary, provide adequate earthing for the workpiece.

Switch off unused devices.

Wear a safety harness if working at height.

Before working on the device, switch it off and pull out the mains plug.

Attach a clearly legible and easy-to-understand warning sign to the device to prevent anyone from plugging the mains plug back in and switching it on again.

After opening the device:

- Discharge all live components
- Ensure that all components in the device are de-energised.

If work on live parts is required, appoint a second person to switch off the main switch at the right moment.

Meandering welding currents

If the following instructions are ignored, meandering welding currents can develop with the following consequences:

- Fire hazard
 - Overheating of parts connected to the workpiece
 - Irreparable damage to ground conductors
 - Damage to device and other electrical equipment
-

Ensure that the workpiece is held securely by the workpiece clamp.

Attach the workpiece clamp as close as possible to the area that is to be welded.

Position the device with sufficient insulation against electrically conductive environments, e.g. Insulation against conductive floor or insulation to conductive racks.

If distribution boards, twin-head mounts, etc., are being used, note the following: The electrode of the welding torch / electrode holder that is not used is also live. Make sure that the welding torch / electrode holder that is not used is kept sufficiently insulated.

In the case of automated MIG/MAG applications, ensure that only an insulated wire electrode is routed from the welding wire drum, large wirefeeder spool or wirespool to the wirefeeder.

EMC Device Classifications

Devices in emission class A:

- Are only designed for use in industrial settings
 - Can cause line-bound and radiated interference in other areas
-

Devices in emission class B:

- Satisfy the emissions criteria for residential and industrial areas. This is also true for residential areas in which the energy is supplied from the public low-voltage mains.
-

EMC device classification as per the rating plate or technical data.

EMC measures

In certain cases, even though a device complies with the standard limit values for emissions, it may affect the application area for which it was designed (e.g. when there is sensitive equipment at the same location, or if the site where the device is installed is close to either radio or television receivers).

If this is the case, then the operator is obliged to take appropriate action to rectify the situation.

Check and evaluate the immunity to interference of nearby devices according to national and international regulations. Examples of equipment that may be susceptible to interference from the device include:

- Safety devices
 - Power, signal and data transfer lines
 - IT and telecommunications devices
 - Measuring and calibrating devices
-

Supporting measures for avoidance of EMC problems:

1. Mains supply

- If electromagnetic interference arises despite correct mains connection, additional measures are necessary (e.g. use a suitable line filter).

2. Welding power leads
 - must be kept as short as possible
 - must run close together (to avoid EMF problems)
 - must be kept well apart from other leads
3. Equipotential bonding
4. Earthing of the workpiece
 - If necessary, establish an earth connection using suitable capacitors.
5. Shielding, if necessary
 - Shield off other nearby devices
 - Shield off entire welding installation

EMF measures

Electromagnetic fields may pose as yet unknown risks to health:

- effects on the health of others in the vicinity, e.g. wearers of pacemakers and hearing aids
- wearers of pacemakers must seek advice from their doctor before approaching the device or any welding that is in progress
- for safety reasons, keep distances between the welding cables and the welder's head/torso as large as possible
- do not carry welding cables and hosepacks over the shoulders or wind them around any part of the body

Specific hazards

Keep hands, hair, clothing and tools away from moving parts. For example:

- Fans
- Cogs
- Rollers
- Shafts
- Wirespools and welding wires

Do not reach into the rotating cogs of the wire drive or into rotating drive components.

Covers and side panels may only be opened/removed while maintenance or repair work is being carried out.

During operation

- Ensure that all covers are closed and all side panels are fitted properly.
- Keep all covers and side panels closed.

The welding wire emerging from the welding torch poses a high risk of injury (piercing of the hand, injuries to the face and eyes, etc.).

Therefore always keep the welding torch away from the body (devices with wire-feed unit) and wear suitable protective goggles.

Never touch the workpiece during or after welding - risk of burns.

Slag can jump off cooling workpieces. The specified protective equipment must therefore also be worn when reworking workpieces, and steps must be taken to ensure that other people are also adequately protected.

Welding torches and other parts with a high operating temperature must be allowed to cool down before handling.

Special provisions apply in areas at risk of fire or explosion - observe relevant national and international regulations.

Power sources for work in areas with increased electric risk (e.g. near boilers) must carry the "Safety" sign. However, the power source must not be located in such areas.

Risk of scalding from escaping coolant. Switch off cooling unit before disconnecting coolant flow or return lines.

Observe the information on the coolant safety data sheet when handling coolant. The coolant safety data sheet may be obtained from your service centre or downloaded from the manufacturer's website.

Use only suitable load-carrying equipment supplied by the manufacturer when transporting devices by crane.

- Hook chains and/or ropes onto all suspension points provided on the load-carrying equipment.
 - Chains and ropes must be at the smallest angle possible to the vertical.
 - Remove gas cylinder and wire-feed unit (MIG/MAG and TIG devices).
-

If the wire-feed unit is attached to a crane holder during welding, always use a suitable, insulated wirefeeder hoisting attachment (MIG/MAG and TIG devices).

If the device has a carrying strap or handle, this is intended solely for carrying by hand. The carrying strap is not to be used if transporting with a crane, counterbalanced lift truck or other mechanical hoist.

All lifting accessories (straps, handles, chains, etc.) used in connection with the device or its components must be tested regularly (e.g. for mechanical damage, corrosion or changes caused by other environmental factors).

The testing interval and scope of testing must comply with applicable national standards and directives as a minimum.

Odourless and colourless shielding gas may escape unnoticed if an adapter is used for the shielding gas connection. Prior to assembly, seal the device-side thread of the adapter for the shielding gas connection using suitable Teflon tape.

Requirement for the shielding gas

Especially with ring lines, contaminated shielding gas can cause damage to equipment and reduce welding quality.

Meet the following requirements regarding shielding gas quality:

- Solid particle size < 40 µm
 - Pressure condensation point < -20 °C
 - Max. oil content < 25 mg/m³
-

Use filters if necessary.

Danger from shielding gas cylinders

Shielding gas cylinders contain gas under pressure and can explode if damaged. As the shielding gas cylinders are part of the welding equipment, they must be handled with the greatest of care.

Protect shielding gas cylinders containing compressed gas from excessive heat, mechanical impact, slag, naked flames, sparks and arcs.

Mount the shielding gas cylinders vertically and secure according to instructions to prevent them falling over.

Keep the shielding gas cylinders well away from any welding or other electrical circuits.

Never hang a welding torch on a shielding gas cylinder.

Never touch a shielding gas cylinder with an electrode.

Risk of explosion - never attempt to weld a pressurised shielding gas cylinder.

Only use shielding gas cylinders suitable for the application in hand, along with the correct and appropriate accessories (regulator, hoses and fittings). Only use shielding gas cylinders and accessories that are in good condition.

Turn your face to one side when opening the valve of a shielding gas cylinder.

Close the shielding gas cylinder valve if no welding is taking place.

If the shielding gas cylinder is not connected, leave the valve cap in place on the cylinder.

The manufacturer's instructions must be observed as well as applicable national and international regulations for shielding gas cylinders and accessories.

Danger from escaping shielding gas

Risk of suffocation from the uncontrolled escape of shielding gas

Shielding gas is colourless and odourless and, in the event of a leak, can displace the oxygen in the ambient air.

- Ensure an adequate supply of fresh air with a ventilation rate of at least 20 m³/hour.
 - Observe safety and maintenance instructions on the shielding gas cylinder or the main gas supply.
 - Close the shielding gas cylinder valve or main gas supply if no welding is taking place.
 - Check the shielding gas cylinder or main gas supply for uncontrolled gas leakage before every start-up.
-

Safety measures at the installation location and during transport

A device toppling over could easily kill someone. Place the device on a solid, level surface such that it remains stable

- The maximum permissible tilt angle is 10°.
-

Special regulations apply in rooms at risk of fire or explosion

- Observe relevant national and international regulations.
-

Use internal directives and checks to ensure that the workplace environment is always clean and clearly laid out.

Only set up and operate the device in accordance with the degree of protection shown on the rating plate.

When setting up the device, ensure there is an all-round clearance of 0.5 m (1 ft. 7.69 in.) to ensure that cooling air can flow in and out freely.

When transporting the device, observe the relevant national and local guidelines and accident prevention regulations. This applies especially to guidelines regarding the risks arising during transport.

Do not lift or transport operational devices. Switch off devices before transport or lifting.

Before transporting the device, allow coolant to drain completely and detach the following components:

- Wirefeeder
 - Wirespool
 - Shielding gas cylinder
-

After transporting the device, the device must be visually inspected for damage before commissioning. Any damage must be repaired by trained service technicians before commissioning the device.

Safety measures in normal operation

Only operate the device when all safety devices are fully functional. If the safety devices are not fully functional, there is a risk of

- injury or death to the operator or a third party
 - damage to the device and other material assets belonging to the operator
 - inefficient operation of the device
-

Any safety devices that are not functioning properly must be repaired before switching on the device.

Never bypass or disable safety devices.

Before switching on the device, ensure that no one is likely to be endangered.

Check the device at least once a week for obvious damage and proper functioning of safety devices.

Always fasten the shielding gas cylinder securely and remove it beforehand if the device is to be transported by crane.

Only the manufacturer's original coolant is suitable for use with our devices due to its properties (electrical conductivity, anti-freeze agent, material compatibility, flammability, etc.).

Only use suitable original coolant from the manufacturer.

Do not mix the manufacturer's original coolant with other coolants.

Only connect the manufacturer's system components to the cooling circuit.

The manufacturer accepts no liability for damage resulting from use of other system components or a different coolant. In addition, all warranty claims will be forfeited.

Cooling Liquid FCL 10/20 does not ignite. The ethanol-based coolant can ignite under certain conditions. Transport the coolant only in its original, sealed containers and keep well away from any sources of ignition.

Used coolant must be disposed of properly in accordance with the relevant national and international regulations. The coolant safety data sheet may be obtained from your service centre or downloaded from the manufacturer's website.

Check the coolant level before starting to weld, while the system is still cool.

Commissioning, maintenance and repair

It is impossible to guarantee that bought-in parts are designed and manufactured to meet the demands made of them, or that they satisfy safety requirements.

- Use only original spare and wearing parts (also applies to standard parts).
 - Do not carry out any modifications, alterations, etc. to the device without the manufacturer's consent.
 - Components that are not in perfect condition must be replaced immediately.
 - When ordering, please give the exact designation and part number as shown in the spare parts list, as well as the serial number of your device.
-

The housing screws provide the ground conductor connection for earthing the housing parts.

Only use original housing screws in the correct number and tightened to the specified torque.

Safety inspection

The manufacturer recommends that a safety inspection of the device is performed at least once every 12 months.

The manufacturer recommends that the power source be calibrated during the same 12-month period.

A safety inspection should be carried out by a qualified electrician

- after any changes are made
- after any additional parts are installed, or after any conversions
- after repair, care and maintenance has been carried out
- at least every twelve months.

For safety inspections, follow the appropriate national and international standards and directives.

Further details on safety inspection and calibration can be obtained from your service centre. They will provide you on request with any documents you may require.

Disposal

Do not dispose of this device with normal domestic waste! To comply with the European Directive on Waste Electrical and Electronic Equipment and its implementation as national law, electrical equipment that has reached the end of its life must be collected separately and returned to an approved recycling facility. Any device that you no longer require must either be returned to your dealer or given to one of the approved collection and recycling facilities in your area. Ignoring this European Directive may have potentially adverse effects on the environment and your health!

Safety symbols

Devices with the CE mark satisfy the essential requirements of the low-voltage and electromagnetic compatibility directives (e.g. relevant product standards of the EN 60 974 series).

Fronius International GmbH hereby declares that the device is compliant with Directive 2014/53/EU. The full text on the EU Declaration of Conformity can be found at the following address: <http://www.fronius.com>

Devices marked with the CSA test mark satisfy the requirements of the relevant standards for Canada and the USA.

Data protection

The user is responsible for the safekeeping of any changes made to the factory settings. The manufacturer accepts no liability for any deleted personal settings.

Copyright

Copyright of these operating instructions remains with the manufacturer.

The text and illustrations are all technically correct at the time of printing. We reserve the right to make changes. The contents of the operating instructions shall not provide the basis for any claims whatsoever on the part of the purchaser. If you have any suggestions for improvement, or can point out any mistakes that you have found in the instructions, we will be most grateful for your comments.

General information

Device concept

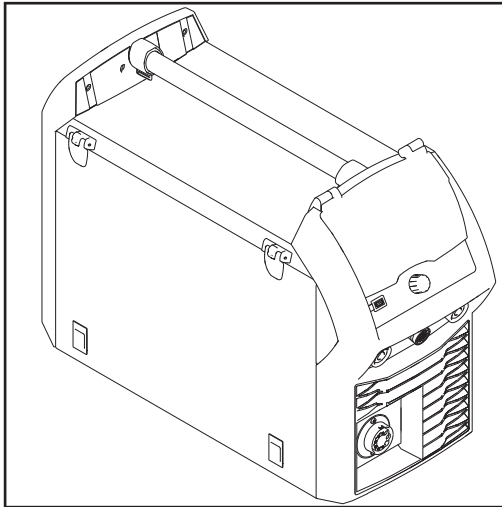

The TPS 320i C MIG/MAG power source is a completely digitised, microprocessor-controlled inverter power source with integrated 4-roller wire drive.

A modular design and potential for system add-ons ensure a high degree of flexibility. There is no longer an interconnecting hosepack between the power source and the wirefeeder. Its compact design makes the TPS 320i C particularly suitable for mobile applications.

The power source can be adapted to any specific situation.

Functional principle

The central control and regulation unit of the power sources is coupled with a digital signal processor. The central control and regulation unit and the signal processor control the entire welding process.

During the welding process, the actual data is measured continuously and the device responds immediately to any changes. Control algorithms ensure that the desired target state is maintained.

This results in:

- a precise welding process
- exact reproducibility of all results
- excellent weld properties.

Application areas

The devices are used in workshops and industry for manual and automated applications with classical steel, galvanised sheets, chrome/nickel and aluminium.

The integral 4-roller wire drive, high performance and light weight of the TPS 320i C power source makes it the ideal choice for portable applications on building sites or in repair workshops.

Conformities**FCC**

This equipment complies with the limit values for an EMC device class A digital device pursuant to Part 15 of the FCC Rules. These limit values are intended to provide an adequate level of protection against harmful emissions when the device is being used in an industrial environment. This device generates and uses high-frequency energy and can cause interference to radio communications if it is not installed and used according to the Operating Instructions.

The use of this device in residential areas will probably cause harmful interference, in which case the user will be obliged to correct the interference at their own expense.

FCC ID: QKWSPBMCU2

Industry Canada RSS

This device complies with the Industry Canada licence-exempt RSS standards. Its use is subject to the following conditions:

- (1) The device must not cause any harmful interference.
- (2) The device must be able to cope with any interference, including that which could adversely affect its operation.

IC: 12270A-SPBMCU2

EU**Conformity with Directive 2014/53 / EU - Radio Equipment Directive (RED)**

When installing the antennae to be used for this transmitter, it is essential to maintain a minimum distance of 20 cm from all people. They must not be set up or operated together with another antenna or another transmitter. To comply with exposure to radio frequency guidelines, the operating conditions of the transmitter must be available to OEM integrators and end users.

ANATEL / Brazil

This device is operated on a secondary basis. It has no protection against harmful interference, even from devices of the same type.

This device cannot cause interference in systems operated on a primary basis.

This device complies with ANATEL's specific absorption rate limit values in relation to exposure to high frequency electric, magnetic and electromagnetic fields.

IFETEL / Mexico

Operation of this device is subject to the following two conditions:

- (1) The device must not cause any harmful interference.
 - (2) This device must accept any interference received, including interference that may cause undesired operation.
-

NCC / Taiwan

In accordance with NCC regulations for low-power radio frequency devices:

Article 12

A certified low-power radio frequency device must not change the frequency, increase the power or alter the characteristics and functions of the original structure without approval.

Article 14

The use of low-power radio frequency devices must not adversely affect flight safety and communications.

A detected malfunction must be deactivated and corrected immediately until no malfunction is present.

The notice in the preceding paragraph refers to radio communications operated in accordance with the provisions of the Telecommunications Act. Low-power radio fre-

quency devices must withstand interference from legitimate communications or radiological, electrical radio frequency devices for industrial, scientific and medical applications.

Thailand









Bluetooth trademarks

The Bluetooth® word mark and logos are registered trademarks owned by Bluetooth SIG, Inc. and any use of such marks by Fronius International GmbH is under license. Other trademarks and trade names are those of their respective owners.

Warning notices on the device

Warning notices and safety symbols are affixed to power sources with the CSA test mark for use in North America (USA and Canada). These warning notices and safety symbols must not be removed or painted over. They warn against incorrect operation, as this may result in serious injury and damage.

⚠ WARNING			ARC RAYS can burn eyes and skin; NOISE can damage hearing. <ul style="list-style-type: none"> Wear welding helmet with correct filter. Wear correct eye, ear and body protection.
Do not Remove, Destroy, Or Cover This Label			EXPLODING PARTS can injure. <ul style="list-style-type: none"> Failed parts can explode or cause other parts to explode when power is applied. Always wear a face shield and long sleeves when servicing.
ARC WELDING can be hazardous. <ul style="list-style-type: none"> Read and follow all labels and the Owner's Manual carefully Only qualified persons are to install, operate, or service this unit according to all applicable codes and safety practices. Keep children away. Pacemaker wearers keep away. Welding wire and drive parts may be at welding voltage. 			ELECTRIC SHOCK can kill; SIGNIFICANT DC VOLTAGE exists after removal of input power <ul style="list-style-type: none"> Always wait 60 seconds after power is turned off before working on unit. Check input capacitor voltage, and be sure it is near 0 before touching parts.
	ELECTRIC SHOCK can kill. <ul style="list-style-type: none"> Always wear dry insulating gloves. Insulate yourself from work and ground. Do not touch live electrical parts. Disconnect input power before servicing. Keep all panels and covers securely in place. 	⚠ AVERTISSEMENT	
	FUMES AND GASES can be hazardous. <ul style="list-style-type: none"> Keep your head out of the fumes. Ventilate area, or use breathing device. Read Material Safety Data Sheets (MSDSs) and manufacturer's instructions for materials used. 	UN CHOC ELECTRIQUE peut etre mortel. <ul style="list-style-type: none"> Installation et raccordement de cette machine doivent etre conformes a tous les pertinents. 	
	WELDING can cause fire or explosion. <ul style="list-style-type: none"> Do not weld near flammable material. Watch for fire: keep extinguisher nearby. Do not locate unit over combustible surfaces. Do not weld on closed containers. 		SOUDEGE A L'ARC peut etre hasardeux. <ul style="list-style-type: none"> Lire le manuel d'instructions avant utilisation. Ne pas installer sur une surface combustible. Les fils de soudage et pieces conductrices peuvent etre a la tension de soudage.

Read American National Standard Z49.1, "Safety in Welding and Cutting" From American Welding Society, 550 N.W. LeJeune Rd., Miami, FL 33126; OSHA Safety and Health Standards, 29 CFR 1910, from U.S. Government Printing Office, Washington, DC 20402. CSA, W117-2, M87 Code for Safety in Welding and Cutting. 42.0409.5074

⚠

1.1

1.2

1.3

2

2.1

2.2

2.3

3

3.1

3.2

3.3

4

4.1

5

6

42.0409.5074

*) on the inside of the device

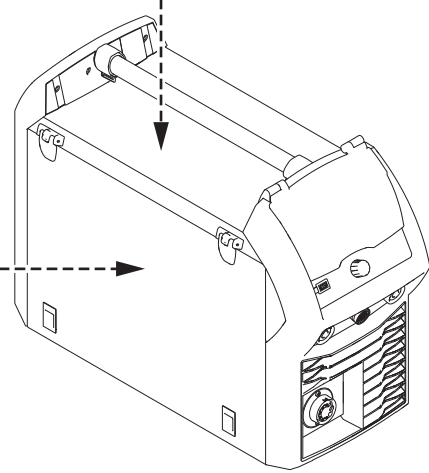

*) on the inside of the device

Safety symbols on the rating plate:



Welding is dangerous. The following basic requirements must be met:

- Welders must be sufficiently qualified
- Suitable protective equipment must be used
- All persons not involved in the welding process must be kept at a safe distance



Do not use the functions described here until you have fully read and understood the following documents:

- These Operating Instructions
- All the Operating Instructions for the system components, especially the safety rules

Description of the warning notices on the device

For certain device versions, warning notices are affixed to the device.

The arrangement of the symbols may vary.

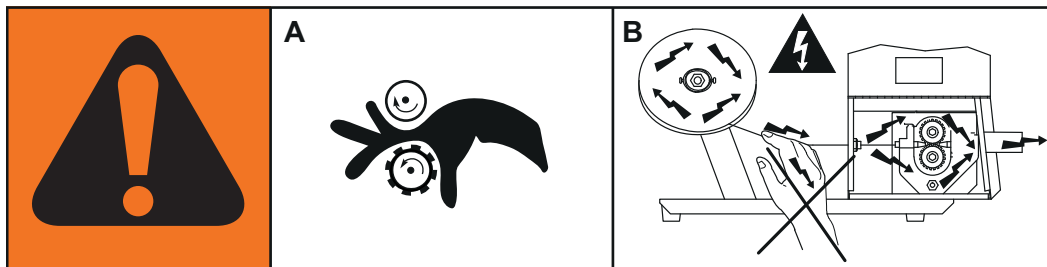

! Warning! Attention!
The symbols represent possible dangers.

A Drive rollers can injure fingers.

B The welding wire and drive parts are live during operation.
 Keep hands and metal objects away!

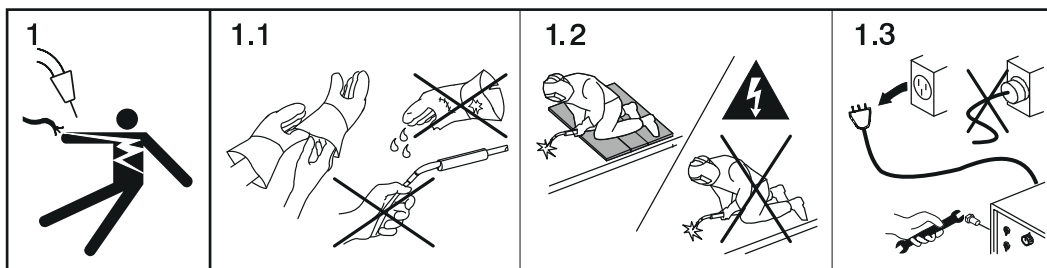

1. An electric shock can be fatal.

1.1 Wear dry, insulating gloves. Do not touch the wire electrode with bare hands. Do not wear wet or damaged gloves.

1.2 Use a base that is insulated from the floor and work area to protect against electric shock.

1.3 Before working on the device, switch off the device and pull out the mains plug or disconnect it from the power supply.

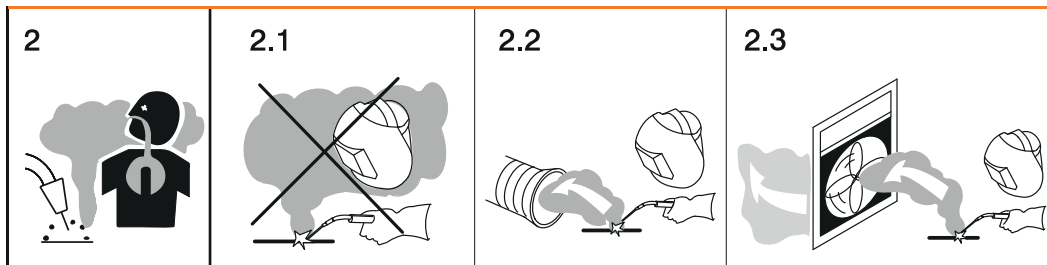

2. Inhalation of welding fumes can be harmful to health.

2.1 Keep your face away from any welding fumes.

2.2 Use forced-air ventilation or a local extraction system to remove welding fumes.

2.3 Remove welding fumes with a fan.

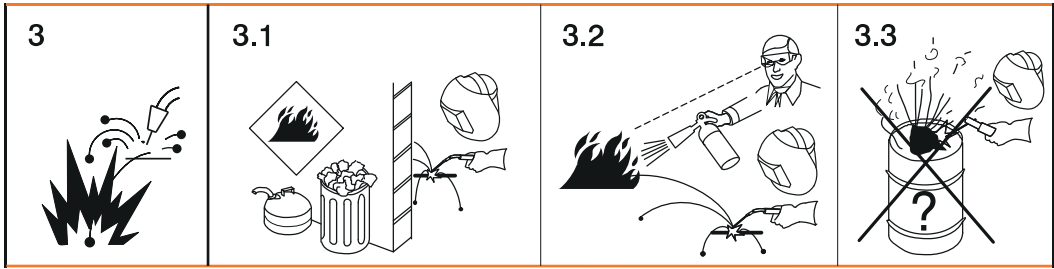

3 Welding sparks can cause an explosion or fire.

3.1 Keep flammable materials away from the welding process. Never weld close to flammable materials.

3.2 Welding sparks can cause a fire. Have fire extinguishers to hand. If necessary, have a supervisor ready who can operate the fire extinguisher.

3.3 Do not weld on drums or closed containers.

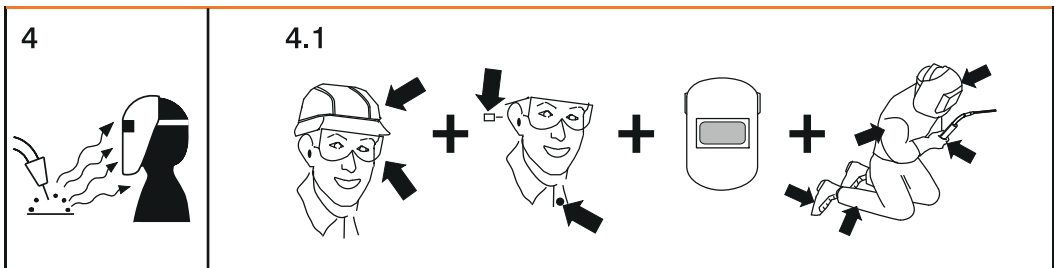

4. Arc rays can burn the eyes and injure the skin.

4.1 Wear headgear and protective goggles. Use ear protection and a shirt collar with button. Use a welding helmet with the correct tinting. Wear suitable protective clothing over the entire body.

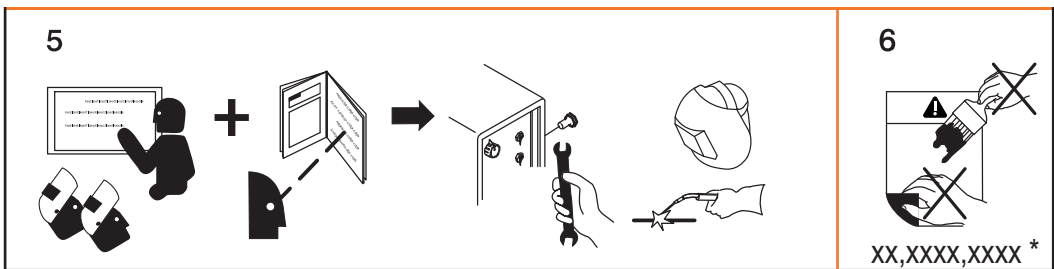

5. Before working on the system or welding: undertake training on the device and read the instructions!

6. Do not remove or paint over the warning sticker.

* Manufacturer order number of the sticker

Welding packages, welding characteristics and welding processes

General Various welding packages, welding characteristics and welding processes are available with TPSi power sources that enable a wide range of materials to be effectively welded.

Welding packages The following welding packages are available for TPSi power sources:

- Standard Welding Package
(enables MIG/MAG standard synergic welding)
- Pulse Welding Package
(enables MIG/MAG pulse synergic welding)
- LSC Welding Package *
(enables the LSC process)
- PMC Welding Package **
(enables the PMC process)
- CMT Welding Package ***
(enables the CMT process)

* only in conjunction with the Standard Welding Package
 ** only in conjunction with the Pulse Welding Package
 *** only in conjunction with the Standard Welding Package and the Pulse Welding Package

IMPORTANT! A TPSi power source without welding packages only offers the following welding processes:

- MIG/MAG standard manual welding
- TIG welding
- MMA welding

Welding characteristics Depending on the welding process and shielding gas mix, various process-optimised welding characteristics are available when selecting the filler metal.

Examples of welding characteristics:

- MIG/MAG 3700 PMC Steel 1.0 mm M21 - arc blow *
- MIG/MAG 3450 PMC Steel 1.0 mm M21 - dynamic *
- MIG/MAG 3044 Pulse AlMg5 1.2 mm I1 - universal *
- MIG/MAG 2684 Standard Steel 0.9 mm M22 - root *

The additional designation (*) next to the welding process provides information about the special properties and use of the welding characteristic.

The description of the characteristics is set out as follows:

Marking

Welding process
Properties

arc blow

PMC

Characteristic with improved arc break properties by deflecting the external magnetic fields

braze

CMT, LSC, PMC

Characteristics for brazing processes (high brazing speed, reliable wetting and good flow of braze material)

braze+

CMT

Optimised characteristics for brazing processes with special "Braze+" gas nozzle (narrow gas nozzle opening, high shielding gas flow rate)

cladding

CMT, LSC, PMC

Characteristic for cladding with low penetration, low dilution and wide weld seam flow for improved wetting

dynamic

CMT, PMC, Pulse, Standard

Characteristics for high welding speeds with concentrated arc

flanged edge

CMT

Characteristics for flange welds with frequency and energy yield adjustments; the edge is fully covered with the weld seam but not melted down

galvanized

CMT, LSC, PMC, Pulse, Standard

Characteristics for galvanised sheet surfaces (low zinc pore risk, reduced zinc melting loss)

galvannealed

PMC

Characteristics for iron-zinc coated sheet surfaces

gap-bridging

CMT, PMC

Characteristics with very low heat input for optimum gap-bridging ability

hot spot

CMT

Characteristics with hot start sequence, specifically for plug welds and MIG/MAG spot weld joints

mix **

PMC

also required: Pulse and PMC welding packages

Characteristics with process switch between pulsed and dip transfer arc
Specially for welding vertical-up seams with cyclic change between a hot and cold supporting process phase.

mix ** / ***

CMT

also required: CMT drive unit WF 60i Robacta Drive CMT, Pulse, Standard and CMT welding packages

Characteristics with process switch between pulsed and CMT, where the CMT process is initiated by wire movement reversal.

mix drive ***

PMC

also required: PushPull drive unit WF 25i Robacta Drive or WF 60i Robacta Drive CMT, Pulse and PMC welding packages

Characteristics with process switch between pulsed and dip transfer arc, where the dip transfer arc is initiated by wire movement reversal.

multi arc

PMC

Characteristics for components being welded by several arcs each influencing the other

PCS **

PMC

Pulse Controlled Sprayarc - Direct transition from the concentrated pulsed arc to a short spray arc. The advantages of pulsed and standard arcs combined in a single characteristic

pipe

PMC

Characteristic for pipe applications and positional welding on narrow gap applications

retro

CMT, Pulse, PMC, Standard

Characteristics with the properties of the TransPuls Synergic (TPS) predecessor series

ripple drive ***

PMC

also required:

CMT drive unit WF 60i Robacta Drive CMT

Characteristics that behave like interval mode for clear weld rippling, especially with aluminium

root

CMT, LSC, Standard

Characteristics for root passes with powerful arc

TIME

PMC

Characteristics for welding with long stick out and TIME shielding gases (T.I.M.E. = Transferred Ionized Molten Energy)

universal

CMT, PMC, Pulse, Standard

Characteristics for conventional welding tasks in renowned Fronius quality

WAAM

CMT

Characteristics with reduced heat input and greater stability at a higher deposition rate for welding bead onto bead in adaptive structures

weld+

CMT

Characteristics for welding with short Stick out and Braze+ gas nozzle (Gas nozzle with small opening and high flow velocity)

** Mixed process characteristics

*** Welding characteristics with special properties provided by additional hardware

**Summary of
MIG/MAG pulse
synergic welding**

MIG/MAG pulse synergic

MIG/MAG pulse synergic welding is a pulsed-arc process with controlled material transfer.

In the base current phase, the energy supply is reduced to such an extent that the arc is only just stable and the surface of the workpiece is preheated. In the pulsing current phase, a precise current pulse ensures the targeted detachment of a droplet of welding material.

This principle guarantees a low-spatter weld and precise working across the entire power range.

**Summary of
MIG/MAG stand-
ard synergic
welding**

MIG/MAG standard synergic

The MIG/MAG standard synergic welding process is a MIG/MAG welding process across the entire power range of the power source with the following arc types:

Short circuit arc

Droplet transfer takes place during a short circuit in the lower power range.

Intermediate arc

The droplet increases in size on the end of the wire electrode and is transferred in the mid-power range during the short circuit.

Spray arc

A short circuit-free transfer of material in the high power range.

**Summary of the
PMC process**

PMC = Pulse Multi Control

PMC is a pulsed arc welding process with high-speed data processing, precise recording of the process status and improved droplet detachment. Faster welding possible with a stable arc and even fusion penetration.

**Summary of the
LSC process**

LSC = Low Spatter Control

LSC is a new, low-spatter dip transfer arc process. The current is reduced before breaking the short-circuit bridge; re-ignition takes place at significantly lower welding current values.

**Summary of Syn-
chroPulse weld-
ing**

SynchroPulse is available for all processes (standard/pulsed/LSC/PMC).

Due to the cyclical change of welding power between two operating points, SynchroPulse achieves a flaking seam appearance and non-continuous heat input.

**Summary of the
CMT process**

CMT = Cold Metal Transfer

A special CMT drive unit is required for the CMT process.

The reversing wire movement in the CMT process results in a droplet detachment with improved dip transfer arc properties.

The advantages of the CMT process are as follows

- Low heat input
- Less spattering
- Reduced emissions
- High process stability

The CMT process is suitable for:

- Joint welding, cladding and brazing – particularly in the case of high requirements in terms of heat input and process stability
- Welding on light-gauge sheet with minimal distortion
- Special connections, such as copper, zinc, and steel/aluminium

NOTE!

A CMT reference book is available complete with typical applications; see ISBN 978-3-8111-6879-4.

Short description of the CMT Cycle Step welding process

CMT Cycle Step is the next step in the development of the CMT welding process. A special CMT drive unit is also required for this process.

CMT Cycle Step is the welding process with the lowest heat input.

The CMT Cycle Step welding process switches cyclically between CMT welding and pauses of an adjustable duration.

These pauses in the welding process lower the heat input; the continuity of the weld seam is maintained.

Individual CMT cycles are also possible. The size of the CMT spot welds is determined by the number of CMT cycles.

System components

General

The power sources can be operated with various system components and options. This makes it possible to optimise procedures and to simplify machine handling and operation, as necessitated by the particular field of application in which the power source is to be used.

Overview

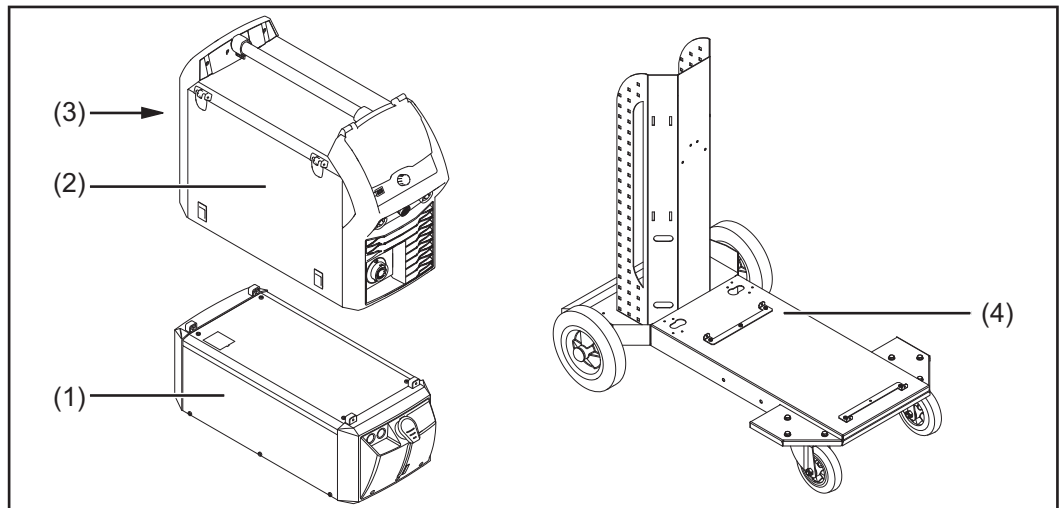

- (1) Cooling units
- (2) Power sources
- (3) Robot accessories
- (4) Trolley and gas cylinder holders

also:

- Welding torch
- Grounding cable and electrode cable
- Dust filter
- Additional current sockets

Options

OPT/i gas flow rate sensor

OPT/i gas pressure sensor

OPT/i TPS 320i C CMT

OPT/i TPS 320i C TIG

OPT/i TPS 320i C wire end

OPT/i TPS 320i C PushPull

OPT/i TPS C wire feed

OPT/i TPS C polarity reverser

OPT/i TPS C QC DFS AD10

OPT/i TPS C QC DFS Powerliner

OPT/i TPS VRD

OPT/i Ext. Sensor connector

OPT/i TPS 320i C viewing window

OPT/i TPS C SpeedNet Connector

Optional second SpeedNet connection socket

Factory-installed on the rear of the power source.

OPT/i TPS dust filter

IMPORTANT! Use of the OPT/i TPS dust filter option shortens the duty cycle.

OPT/i TPS C 2nd plus socket

2nd (+) current socket on the rear of the power source (option)

OPT/i TPS C 2nd earth socket

2nd (-) current socket on the rear of the power source (option)

OPT/i Synergic Lines

Option for enabling all special characteristics available on TPSi power sources; this also automatically enables special characteristics created in future.

OPT/i GUN Trigger

Option for special functions in conjunction with the torch trigger

OPT/i Jobs

Option for Job mode

OPT/i Documentation

Option for the documentation function

OPT/i Interface Designer

Option for individual interface configuration

OPT/i WebJobEdit

Option for editing jobs via the SmartManager of the power source

OPT/i Limit Monitoring

Option for specifying the limit values for the welding current, welding voltage and wire speed

OPT/i Custom NFC - ISO 14443A

Option to use a customer-specific frequency band for key cards

OPT/i CMT Cycle Step

Option for adjustable, cyclical CMT welding process

OPT/i OPC-UA

Standardised data interface protocol

OPT/i MQTT

Standardised data interface protocol

Controls, connections and mechanical components

Control panel

General

Welding parameters can be easily changed and selected using the adjusting dial. The parameters are shown on the display while welding is in progress.

The synergic function ensures that other welding parameters are also adjusted whenever an individual parameter is changed.

NOTE!

As a result of firmware updates, you may find that your device has certain functions that are not described in these operating instructions, or vice versa.

Certain illustrations may also differ slightly from the actual controls on your device, but these controls function in exactly the same way.

Safety



WARNING!

Danger from incorrect operation.

Possible serious injury and damage to property.

- ▶ Do not use the functions described here until you have read and completely understood these Operating Instructions.
 - ▶ Do not use the functions described here until you have fully read and understood all of the Operating Instructions for the system components, in particular the safety rules!
-

Control panel



43,0001,3547

No.	Function
-----	----------

(1)	USB port
-----	-----------------

	For connecting USB flash drives (such as service dongles and licence keys). IMPORTANT! The USB port is not electrically isolated from the welding circuit. Therefore, devices that establish an electrical connection with another device must not be connected to the USB port.
--	--

(2)	Adjusting dial with turn/press function
-----	--

	To select elements, set values and scroll through lists
--	---

(3)	Display (touchscreen)
-----	------------------------------

- | | |
|--|---|
| | <ul style="list-style-type: none">- For operating the power source directly by pressing the buttons on the display- For displaying values- For navigating in the menu |
|--|---|

(4)	Key card reader for NFC keys
-----	-------------------------------------

- | | |
|--|---|
| | <ul style="list-style-type: none">- For locking/unlocking the power source using NFC keys- For logging on different users (with active user management and assigned NFC keys) NFC key = NFC card or NFC key ring |
|--|---|

(5) Wire threading button

To thread the wire electrode into the torch hosepack with no accompanying flow of gas or current

(6) Gas-test button

For setting the required gas flow rate on the gas pressure regulator.

After pressing this button, gas flows for 30 seconds. Press the button again to stop the gas flow prematurely.

Connections, switches and mechanical components

TPS 320i C power source

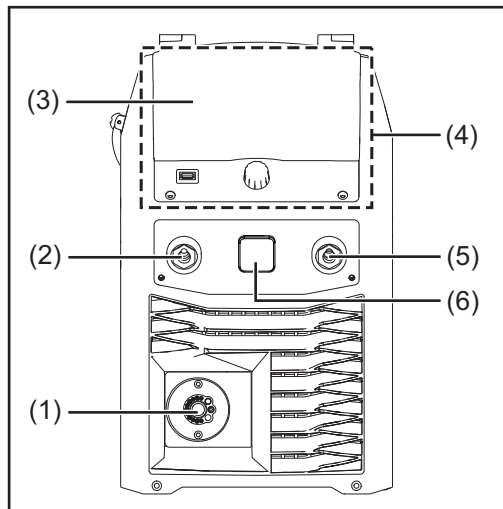

Front

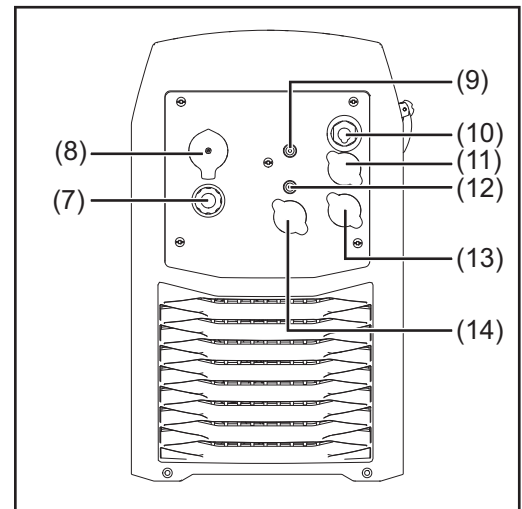

Rear

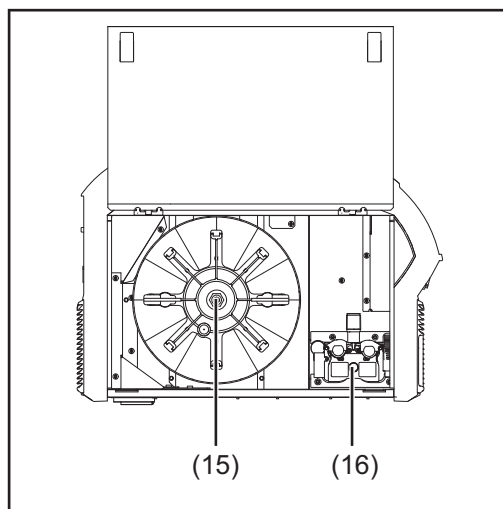

Side view

No.	Function
(1)	Welding torch connection for connecting the welding torch
(2)	(-) current socket with bayonet latch used to connect the grounding cable during MIG/MAG welding
(3)	Control panel cover for protecting the control panel
(4)	Control panel with display for operating the power source
(5)	(+) current socket with bayonet latch
(6)	Blanking cover reserved for the TMC connection socket of the TIG option

-
- (7) **Mains cable with strain relief device**
-
- (8) **Mains switch**
for switching the power source on and off
-
- (9) **Blanking cover**
reserved for TIG shielding gas connection option
-
- (10) **Blanking cover**
reserved for optional 2nd (-) current socket or 2nd (+) current socket
-
- (11) **Blanking cover**
reserved for external sensor option
-
- (12) **MIG/MAG shielding gas connection**
-
- (13) **Blanking cover**
reserved for the Ethernet connection socket
-
- (14) **Blanking cover**
reserved for optional 2nd SpeedNet connection
-
- (15) **Wirespool holder with brake**
for holding standard wirespools weighing up to 16 kg (35.27 lbs) and with a max. diameter of 300 mm (11.81 in)
-
- (16) **4 roller drive**
-

Operating concept

Input options

General

NOTE!

As a result of firmware updates, you may find that there are functions available on your device that are not described in these operating instructions or vice versa.

Certain illustrations may also differ slightly from the actual controls on your device, but these controls function in exactly the same way.

⚠ WARNING!

Incorrect operation may result in serious injury or damage.

the following documents:

- ▶ Do not use the functions described here until you have thoroughly read and understood these operating instructions
- ▶ Do not use the functions described here until you have thoroughly read and understood all the operating instructions for the system components, especially the safety rules

The following input options are available on the power source control panel:

- Turning/pressing the adjusting dial
- Pressing buttons
- Pressing on the display

Turning/pressing the adjusting dial

Turn/press the adjusting dial to select elements, change values and scroll through lists.



Turn the adjusting dial to:

Select elements from the main area of the display:

- Turning right highlights the next element in the sequence.
- Turning left highlights the preceding element in the sequence.
- In vertical lists, turn right to scroll down and turn left to scroll up.

Change values:

- Turning to the right increases the value.
- Turning to the left decreases the value.
- Slowly turning the adjusting dial changes the value in very small stages, i.e. for precision adjustments.
- Turning the adjusting dial quickly changes the value in disproportionately large stages, i.e. large value changes can be made quickly.

For certain parameters (wire speed, welding current, arc length correction, etc.), a value changed by turning the adjusting dial is applied automatically without having to press the adjusting dial.



Press the adjusting dial to:

Apply highlighted elements, e.g. to change the welding parameter value.

Apply certain welding parameter values.

Pressing buttons Pressing buttons triggers the following functions:



When the feeder inching button is pressed, the wire electrode is fed into the torch hosepack with no accompanying flow of gas or current.



When the gas test button is pressed, gas will flow out for 30 seconds. Press the button again to stop the gas test flow before the end of this period.

Pressing on the display



The display can be touched in order to

- navigate,
- trigger functions,
- select options

Pressing on (and therefore selecting) an element on the display highlights this element.

Display and status line

Display

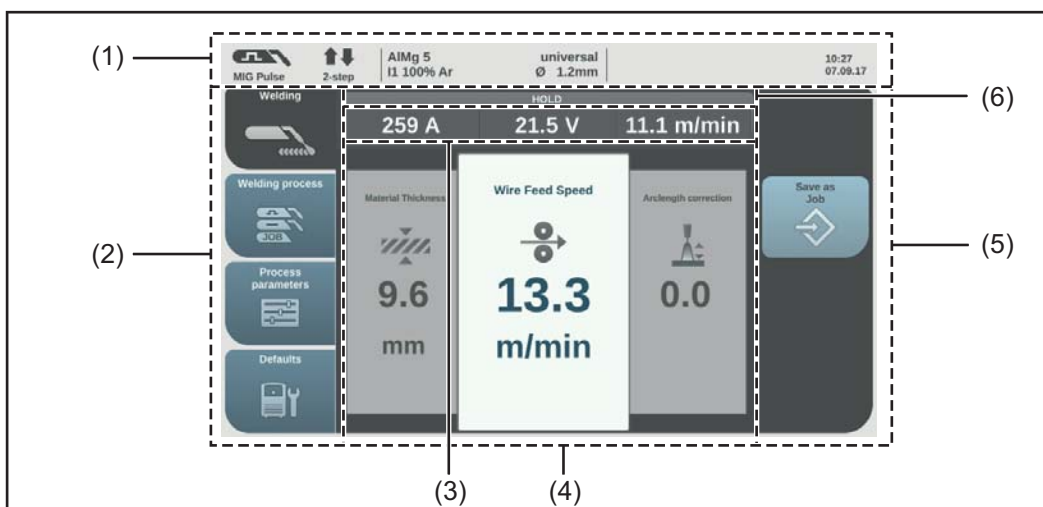

No.	Function
(1)	Status bar The status bar provides information on: <ul style="list-style-type: none"> - The current welding process - The current operating mode - The current welding program (material, shielding gas and wire diameter) - Active stabilizers and special processes - Bluetooth status - Logged-on users / power source locked state - Active faults - Time and date
(2)	Left-hand ribbon The left-hand ribbon contains the following buttons: <ul style="list-style-type: none"> - Welding - Welding process - Process parameters - Defaults <p>The buttons in the left-hand ribbon are actuated by touching the display.</p>
(3)	Actual value display Welding current, welding voltage, wire speed
(4)	Main area The welding parameters, graphics, lists or navigation elements are shown in the main area. The structure of the main area and the elements shown in it vary according to the application. The main area is operated <ul style="list-style-type: none"> - using the adjusting dial, - by touching the display.

(5) Right-hand ribbon

Depending on the button selected in the left-hand ribbon, the right-hand ribbon may be used as follows:

- as a function ribbon containing application and function buttons
- for navigating through the 2nd menu level

The buttons in the right-hand ribbon are actuated by touching the display.

(6) HOLD indicator

At the end of each welding operation, the actual values for the welding current and welding voltage are stored - HOLD lights up.

Status bar

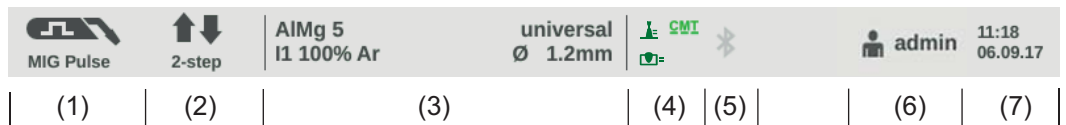

The status bar is divided into segments and contains the following information:

- (1) Current welding process
- (2) Current operating mode
- (3) Current welding program (material, shielding gas, characteristic and wire diameter)
- (4) Stabilizers/CMT Cycle Step active indicator

 Arc lengths

 Penetration stabilizer

 CMT Cycle Step (only in combination with the CMT welding process)

Symbol lights up green:
Stabilizer/CMT Cycle Step is active

Symbol is grey:
Stabilizer/CMT Cycle Step is available, but is not being used for welding

- (5) Bluetooth status indicator (certified devices only)

or

intermediate arc indicator



- (6) Current logged-on user (with active user management)

or

the key symbol when the power source is locked (e.g. when the "locked" profile/role is active)



(7) Time and date

Status bar – Current limit reached

If the characteristic-dependent current limit is reached while MIG/MAG welding, a corresponding message appears in the status bar.

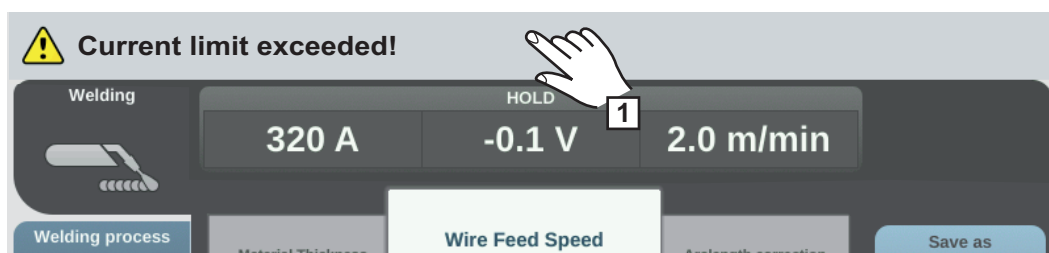

1 For detailed information, select the status bar

The information appears.

2 Select "Hide information" to exit

3 Reduce the wire speed, welding current, welding voltage or material thickness

or

Increase the distance between the contact tip and the workpiece

Further information on the current limit can be found in the Troubleshooting section on page [225](#)

Installation and commissioning

Minimum equipment needed for welding task

General

Depending on which welding process you intend to use, a certain minimum equipment level will be needed in order to work with the power source. The welding processes and the minimum equipment levels required for the welding task are then described.

MIG/MAG gas-cooled welding

- Power source
- Grounding (earthing) cable
- MIG/MAG welding torch, gas-cooled
- Shielding gas supply
- Wire electrode

MIG/MAG water-cooled welding

- Power source
- Cooling unit
- Grounding (earthing) cable
- MIG/MAG welding torch, water-cooled
- Shielding gas supply
- Wire electrode

Manual CMT welding

- Power source
- Standard, Pulse and CMT welding packages enabled on the power source
- Grounding cable
- PullMig CMT welding torch incl. CMT drive unit and CMT wire buffer

IMPORTANT! For water-cooled CMT applications, a cooling unit is also required!

- OPT/i PushPull
- CMT interconnecting hosepack
- Wire electrode
- Gas connection (shielding gas supply)

TIG DC welding

- Power source
- Grounding (earthing) cable
- TIG gas-valve torch
- Gas connection (shielding gas supply)
- Filler metal (depending on the application)

MMA welding

- Power source
- Grounding (earthing) cable
- Electrode holder with welding cable
- Rod electrodes

Before installation and commissioning

Safety



WARNING!

Danger from incorrect operation.

Possible serious injury and damage to property.

- ▶ Do not use the functions described here until you have read and completely understood these Operating Instructions.
 - ▶ Do not use the functions described here until you have fully read and understood all of the Operating Instructions for the system components, in particular the safety rules!
-

Proper use

The power source may only be used for MIG/MAG, MMA and TIG welding. Any use above and beyond this purpose is deemed improper. The manufacturer shall not be held liable for any damage arising from such usage.

Proper use also includes:

- following all the information in the operating instructions
 - carrying out all the specified inspection and servicing work
-

Setup regulations

The device is tested to IP 23 protection, meaning:

- protection against penetration by solid foreign bodies with diameters > 12.5 mm (0.49 in.)
- protection against direct sprays of water at any angle up to 60° from the vertical

The device can be set up and operated outdoors in accordance with IP23. Avoid direct wetting (e.g. from rain).



WARNING!

If one of these devices topples over or falls it could cause serious or even fatal injury.

- ▶ Place devices, upright consoles and trolleys on a solid, level surface in such a way that they remain stable.
-

The venting duct is a very important safety feature. When choosing the installation location, ensure that the cooling air can enter and exit unhindered through the air ducts on the front and back of the device. Any electroconductive metallic dust (e.g. from grinding work) must not be allowed to get sucked into the device.

Mains connection

- The devices are designed for the mains voltage specified on the rating plate.
- Devices with a nominal voltage of 3 x 575 V must be operated on three-phase systems with earthed star point.
- If your version of the appliance does not come with mains cables and mains plugs ready-fitted, these must be fitted by a qualified person in accordance with national standards.
- The fuse protection for the mains lead is indicated in the technical data.

⚠ CAUTION!

An inadequately dimensioned electrical installation can cause serious damage.

- ▶ The mains lead and its fuse protection must be dimensioned to suit the local power supply.
The technical data shown on the rating plate applies.

Generator-powered operation

The power source is generator-compatible.

The maximum apparent power $S_{1\max}$ of the power source must be known in order to select the correct generator output.

The maximum apparent power $S_{1\max}$ of the power source is calculated for 3-phase devices as follows:

$$S_{1\max} = I_{1\max} \times U_1 \times \sqrt{3}$$

See device rating plate or technical data for $I_{1\max}$ and U_1 values

The generator apparent power S_{GEN} needed is calculated using the following rule of thumb:

$$S_{\text{GEN}} = S_{1\max} \times 1.35$$

A smaller generator may be used when not welding at full power.

IMPORTANT! The generator apparent power S_{GEN} must always be higher than the maximum apparent power $S_{1\max}$ of the power source.

NOTE!

The voltage delivered by the generator must never exceed the upper or lower limits of the mains voltage tolerance range.

Details of the mains voltage tolerance can be found in the "Technical data" section.

Information on system components

The steps and activities described below include references to various system components, including:

- Trolleys
- Cooling units
- Wire-feed unit holders
- Wire-feed units
- Interconnecting hosepacks
- Welding torches
- etc.

For more detailed information about installing and connecting the system components, please refer to the appropriate operating instructions.

Connecting the mains cable

General

If no mains cable is connected, a mains cable that is suitable for the connection voltage must be fitted before commissioning.
A universal strain-relief device for cable diameters from 12 - 30 mm (0.47 - 1.18 in.) is fitted to the power source.

Strain-relief devices for other cable cross-sections must be designed accordingly.

Stipulated mains cables

Power source
Mains voltage: USA & Canada * | Europe

TPS 320i C /nc
3 x 380 V, 3 x 400 V, 3 x 460 V: AWG 14 | 4G 2.5 mm²

TPS 320i C /MV/nc
3 x 200 V, 3 x 230 V: AWG 10 | 4G 4.0 mm²
3 x 380 V, 3 x 400 V, 3 x 460 V: AWG 14 | 4G 2.5 mm²

TPS 320i C /S/nc **
3 x 460 V, 3 x 575 V: AWG 14 | -

* Cable type for USA / Canada: Extra-hard usage

** Power source without CE mark; not available in Europe

AWG = **A**merican **w**ire **g**auge

Safety



WARNING!

Danger due to work that has been carried out incorrectly.

This can result in serious injury and damage to property.

- ▶ The work described below must only be carried out by trained and qualified personnel.
 - ▶ Observe national standards and directives.
-



CAUTION!

Danger due to improperly prepared mains cable.

This can cause short circuits and damage.

- ▶ Fit ferrules to all phase conductors and the ground conductor of the stripped mains cable.
-

Connecting the mains cable - general

IMPORTANT! The ground conductor should be approx. 20 - 25 mm (0.8 - 1 in.) longer than the phase conductors.

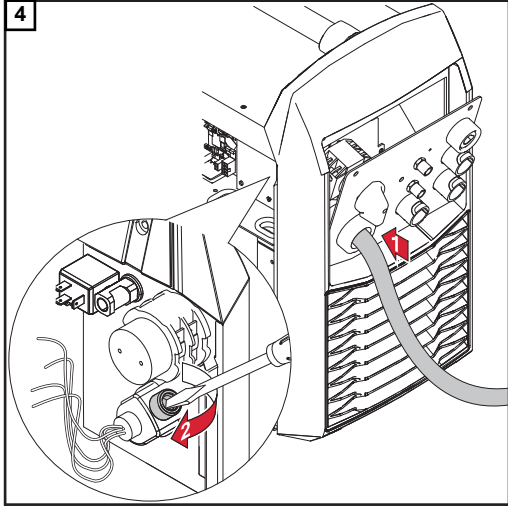
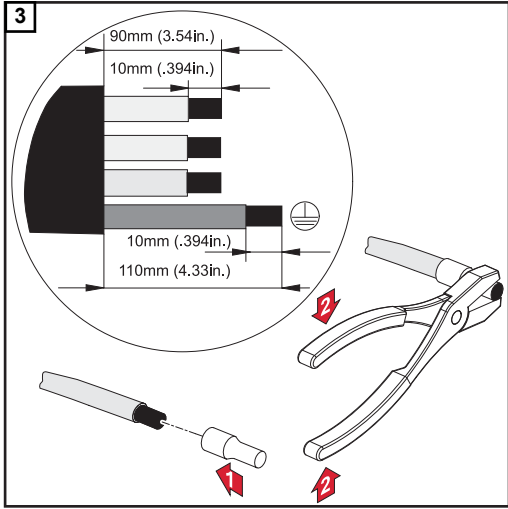
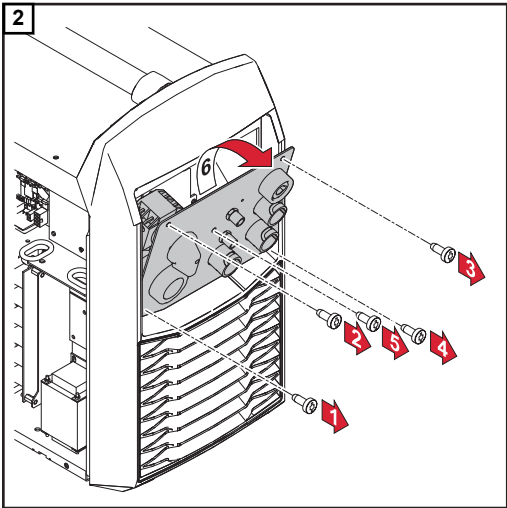
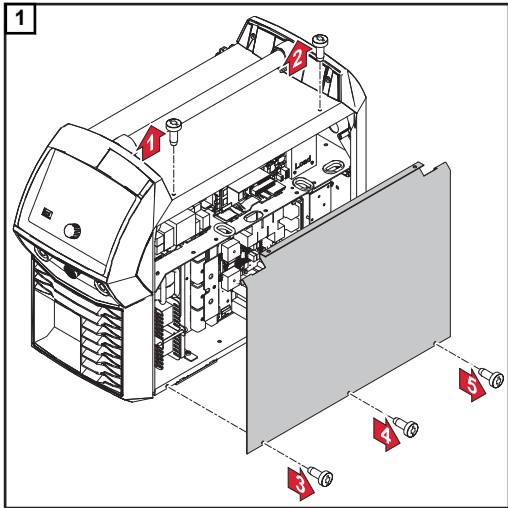

Tightening torque = 1.2 Nm
(TPS 320i C, TPS 320i C /nc,
TPS 320i C /S/nc)

Tightening torque = 3.5 Nm
(TPS 320i C /MV/nc)

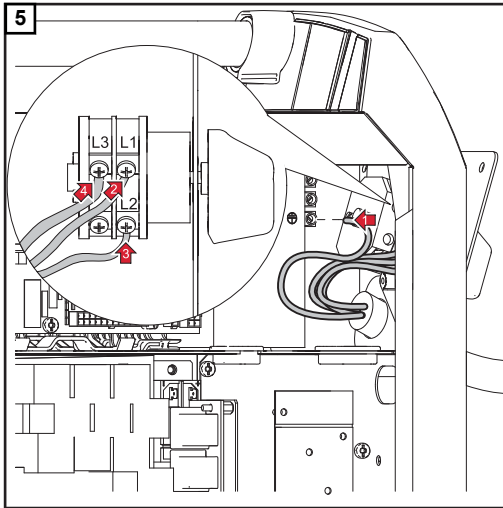

Phase conductor:

Tightening torque = 1.5 Nm, TX 15
 (TPS 320i C, TPS 320i C /nc,
 TPS 320i C /S/nc)

Tightening torque = 1.5 Nm, TX 25
 (TPS 320i C /MV/nc)

Ground conductor:

Tightening torque = 1.2 Nm

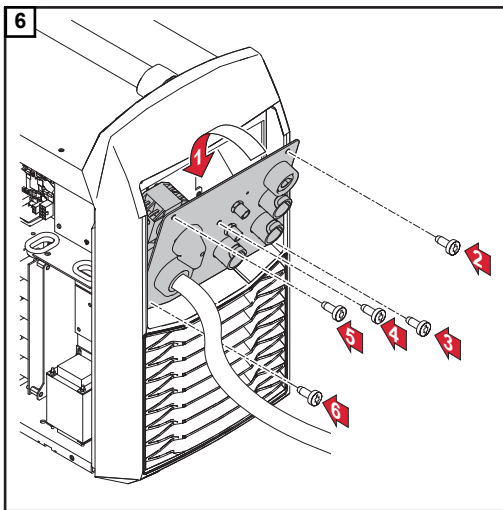

5 x TX25

Tightening torque = 3 Nm

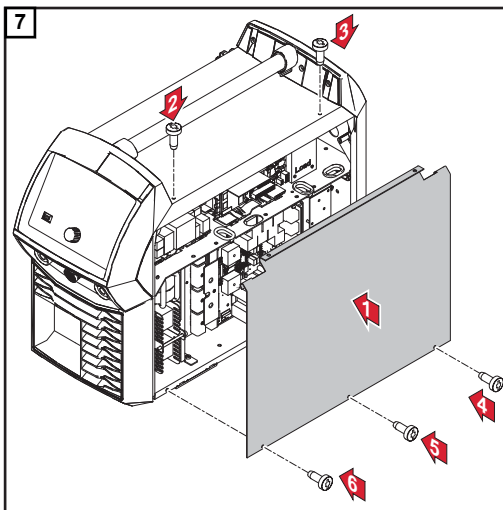

Commissioning the TPS 320i C

Safety



WARNING!

An electric shock can be fatal.

If the power source is connected to the mains electricity supply during installation, there is a high risk of very serious injury and damage.

- ▶ Before carrying out any work on the device make sure that the power source mains switch is in the "O" position
- ▶ Before carrying out any work on the device make sure that the power source is unplugged from the mains



WARNING!

Danger from electrical current due to electrically conductive dust in the device.

This can result in serious injury and damage to property.

- ▶ Only operate the device with an air filter fitted. The air filter is a very important safety device for adhering to the IP 23 protection class.

General

Commissioning the TPS 320i C power source is described by reference to a manual gas-cooled MIG/MAG application.

Recommendation for water-cooled applications

- Use a PickUp 5000 trolley
- Fit the cooling unit to the PickUp 5000 trolley
- Fit the TPS 320i C power source to the cooling unit
- Use only water-cooled welding torches with an external water connection
- Connect the water connections on the welding torch directly to the cooling unit

Connecting the gas cylinder



WARNING!

There is a high risk of very serious injury and damage if a gas cylinder falls over.

- ▶ Place gas cylinders on a solid, level surface so that they remain stable. Secure gas cylinders to prevent them from toppling over.
- ▶ Observe the safety rules of the gas cylinder manufacturer.

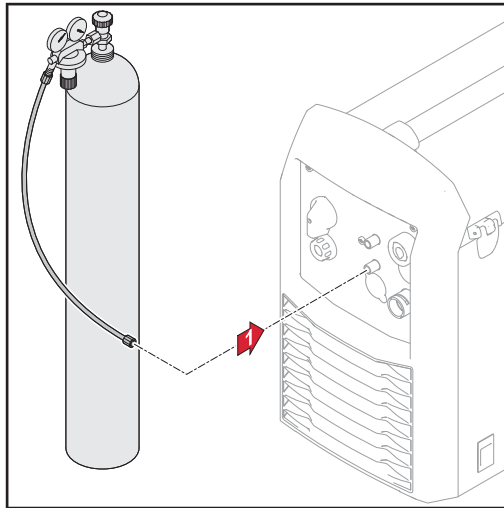

Connecting the gas hose to the TPS 320i C

- 1 Place the gas cylinder on a solid, level surface in such a way that it remains stable
- 2 Secure the gas cylinder to prevent it from toppling over (but not around the neck of the cylinder)
- 3 Take the protective cap off the gas cylinder
- 4 Briefly open the gas cylinder valve to remove any dust or dirt
- 5 Check the seal on the pressure regulator
- 6 Screw the pressure regulator onto the gas cylinder and tighten it
- 7 Connect the pressure regulator to the shielding gas connection on the power source using the gas hose

Establishing a ground earth connection

NOTE!

When establishing a ground earth connection, observe the following points:

- ▶ Use a separate grounding cable for each power source
- ▶ Keep the plus cable and grounding cable together as long and as close as possible
- ▶ Physically separate the welding circuits of individual power sources
- ▶ Do not route several grounding cables in parallel; if parallel routing cannot be avoided, keep a minimum distance of 30 cm between the welding circuits
- ▶ Keep the grounding cable as short as possible, provide a large cable cross-section
- ▶ Do not cross grounding cables
- ▶ Avoid ferromagnetic materials between the grounding cable and the interconnecting hosepack
- ▶ Do not wind up long grounding cables - coil effect!
Lay long grounding cables in loops
- ▶ Do not route grounding cables in iron pipes, metal cable conduits or on steel rails, avoid cable ducts;
(routing of plus cables and grounding cables together in an iron pipe does not cause any problems)
- ▶ If there are several grounding cables, separating the grounding points on the component so that they are as far away from one another as possible is recommended, as well as preventing crossed current paths from occurring underneath the individual arcs.
- ▶ Use compensated interconnecting hosepacks (interconnecting hosepacks with integrated grounding cable)

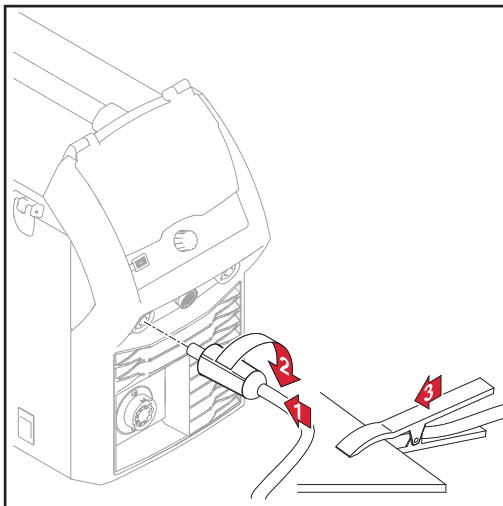

- 1 Plug the grounding cable into the (-) current socket
- 2 Lock the grounding cable in place
- 3 Use the other end of the grounding cable to establish a connection to the workpiece

Connecting the grounding cable to the TPS 320i C

⚠ CAUTION!

A shared ground earth connection for multiple power sources will have an adverse effect on welding results!

If multiple power sources are being used to weld a component, a shared ground earth connection can have a massive impact on the welding results.

- ▶ Separate the welding circuits!
- ▶ Provide a different ground earth connection for each welding circuit!
- ▶ Do not use a single, shared earth (ground) lead!

Connecting the welding torch

- 1 Before connecting the welding torch, check that all cables, lines and hosepacks are undamaged and properly insulated.

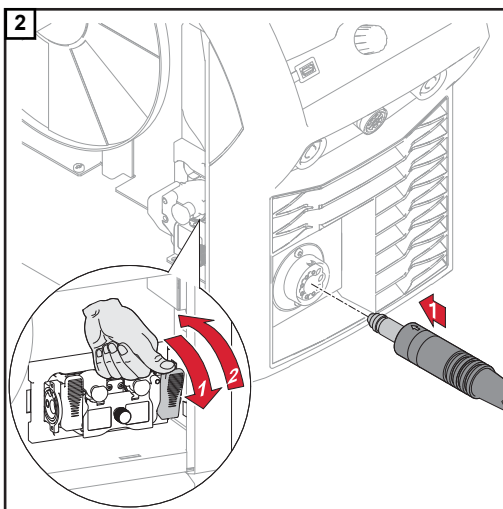

Inserting/replacing feed rollers

In order to achieve optimum wire electrode feed, the feed rollers must be suitable for the diameter and alloy of the wire being welded.

NOTE!

Only use feed rollers that match the wire electrode.

An overview of the feed rollers available and their potential application areas can be found in the Spare Parts Lists.

⚠ CAUTION!

Risk of injury if the feed roller holders fly upwards.

- ▶ When unlocking the lever, keep fingers away from the area to the left and right of the lever.

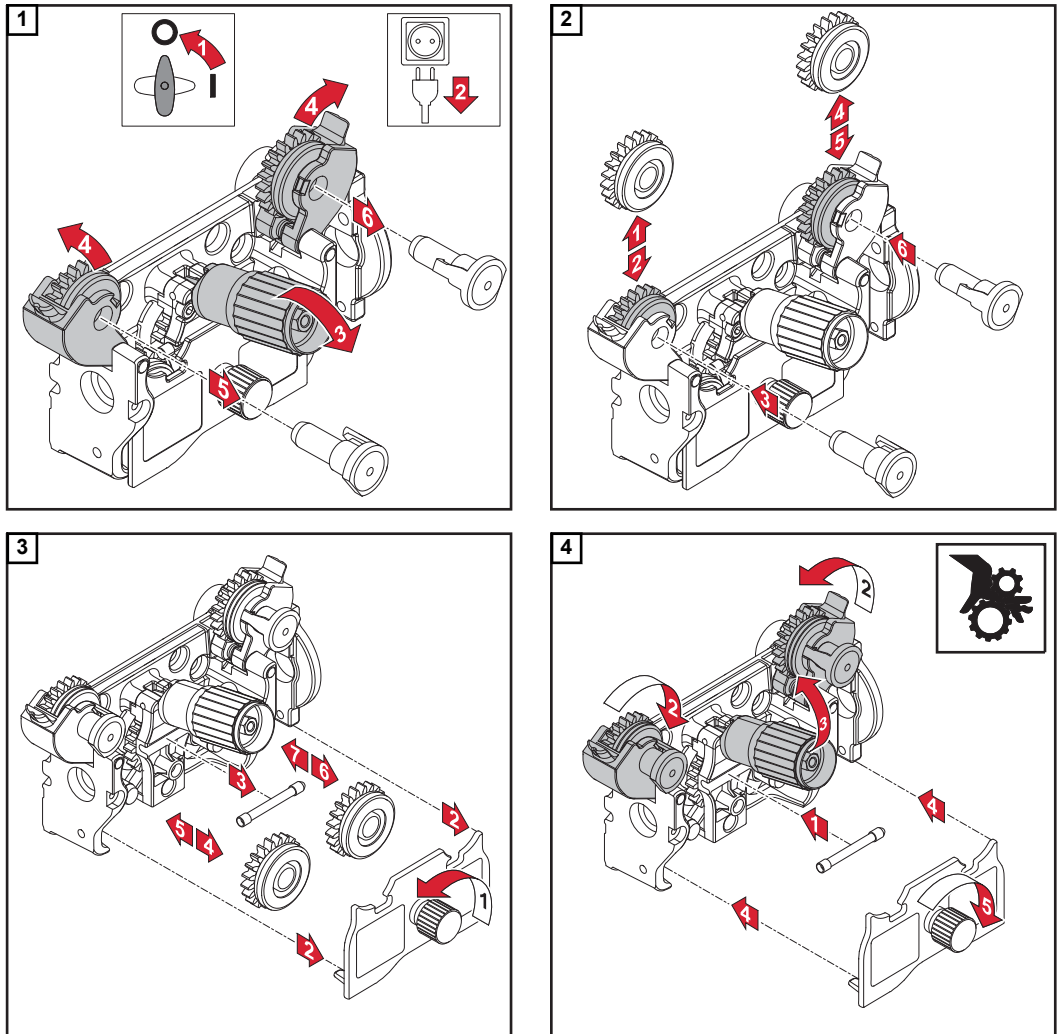

**Inserting the
wirespool**

⚠ CAUTION!

Risk of injury due to springiness of spooled wire electrode.

- ▶ While inserting the wirespool, hold the end of the wire electrode firmly to avoid injuries caused by the wire electrode springing back.

⚠ CAUTION!

Risk of injury from falling wirespool.

- ▶ Make sure that the wirespool is fitted securely to the wirespool holder.

⚠ CAUTION!

Risk of injury and impaired performance if the wirespool topples over because the locking ring has been placed the wrong way round.

- ▶ Always position the locking ring as shown in the diagram on the left.

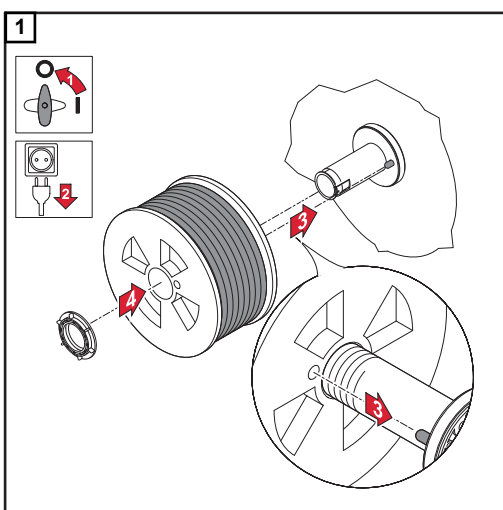
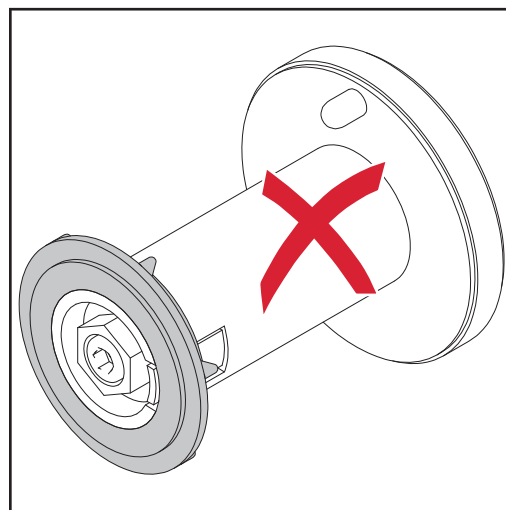
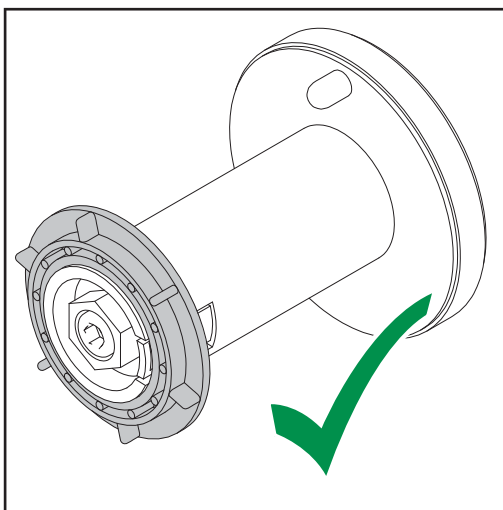

Inserting the basket-type spool

⚠ CAUTION!

Risk of injury due to springiness of spooled wire electrode.

- ▶ While inserting the basket-type spool, hold the end of the wire electrode firmly to avoid injuries caused by the wire electrode springing back.

⚠ CAUTION!

Risk of injury from falling basket-type spool.

- ▶ Make sure that the basket-type spool and basket-type spool adapter are fitted securely to the wirespool holder.

NOTE!

When working with basket-type spools, only use the basket-type spool adapter included in the scope of supply.

⚠ CAUTION!

Risk of injury from falling basket-type spool.

- ▶ Place the basket-type spool on the adapter provided in such a way that the bars on the spool are inside the adapter guideways.

⚠ CAUTION!

Risk of injury and impaired performance if the basket-type spool topples over because the locking ring has been placed the wrong way round.

- ▶ Always position the locking ring as shown in the diagram on the left.

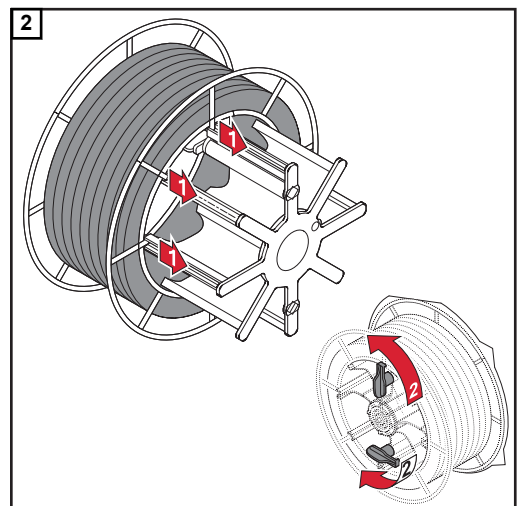
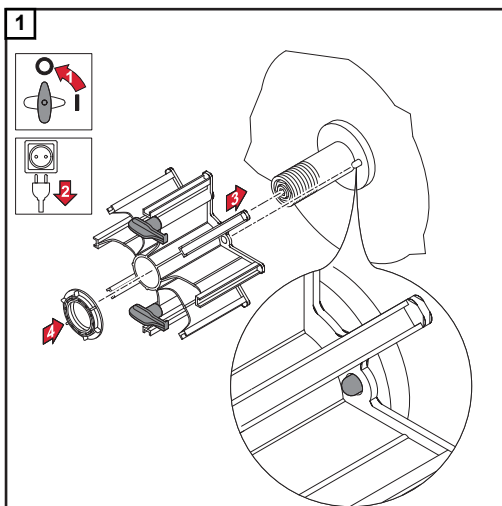
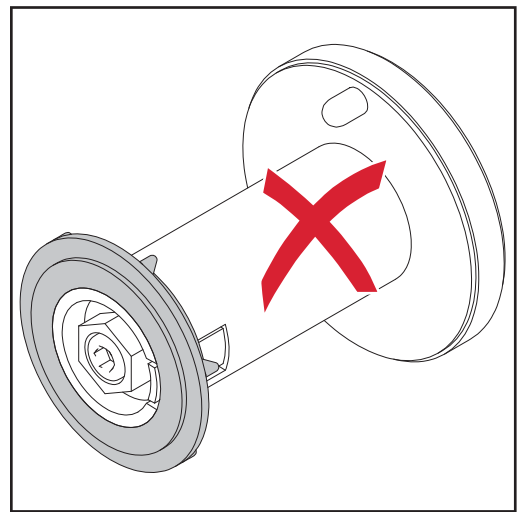
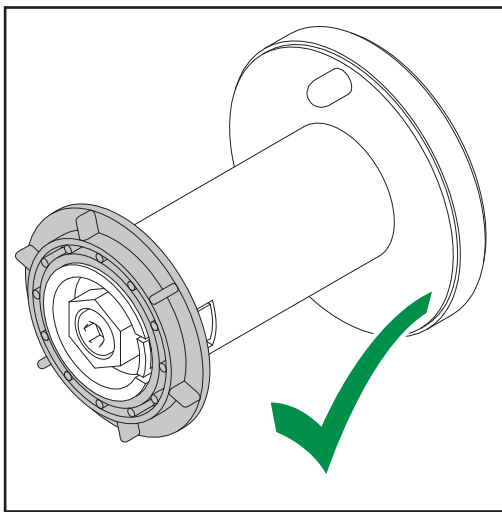

Feeding in the wire electrode

⚠ CAUTION!

Risk of injury due to springiness of spooled wire electrode.

To avoid injuries caused by the wire electrode springing back:

- ▶ When inserting the wire electrode into the 4-roller drive, hold the end of the wire electrode firmly.

⚠ CAUTION!

Risk of damage to the welding torch from sharp end of wire electrode.

- ▶ Deburr the end of the wire electrode well before threading in.
- ▶ Lay the welding torch hosepack as straight as possible.

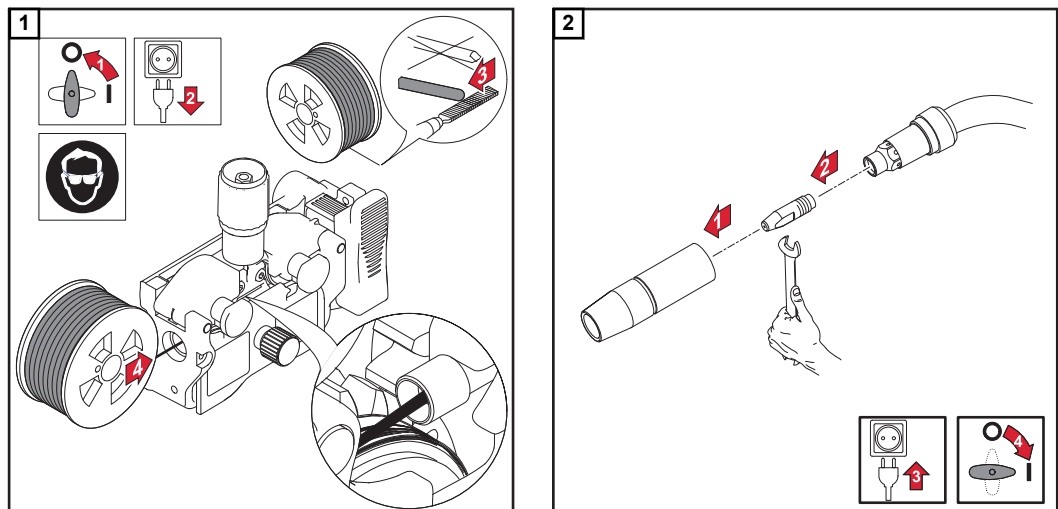

⚠ CAUTION!

Risk of injury and damage from electric shock and from the wire electrode emerging from the torch.

- ▶ Keep the welding torch away from the face and body when pressing the torch trigger or feeder inching button.
- ▶ Do not point the welding torch at people
- ▶ Make sure that the wire electrode does not touch any conductive or earthed (grounded) parts (e.g. the housing, etc.) when pressing the torch trigger

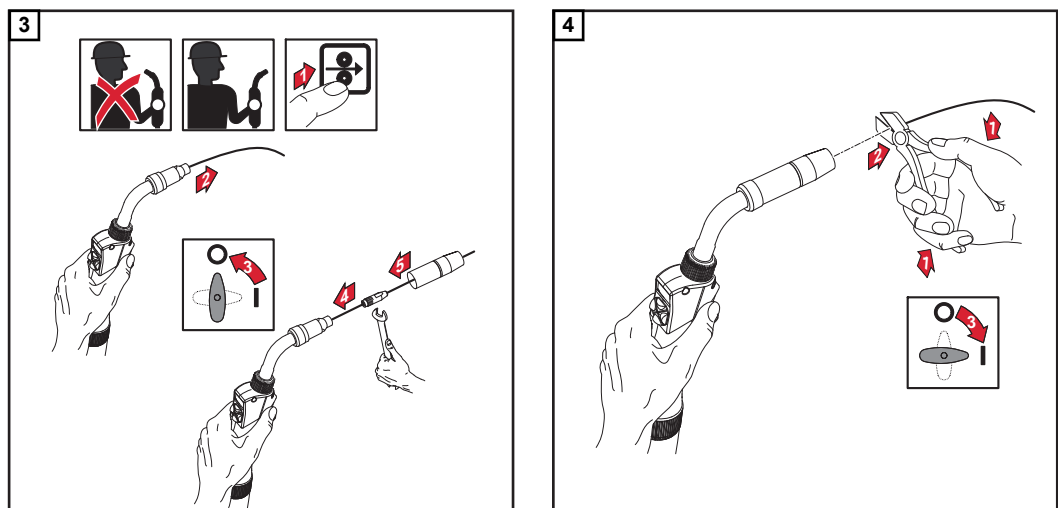

Setting the contact pressure

NOTE!

Set the contact pressure in such a way that the wire electrode is not deformed but nevertheless ensures proper wirefeeding.

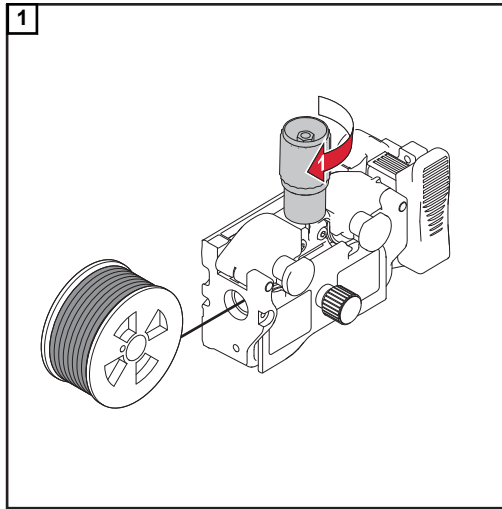

Contact pressure standard values for U-groove rollers

Steel:
4 - 5

CrNi
4 - 5

Tubular cored electrodes
2 - 3

Adjusting the brake

NOTE!

After releasing the torch trigger the wirespool should stop unreeling. Adjust brake if necessary.

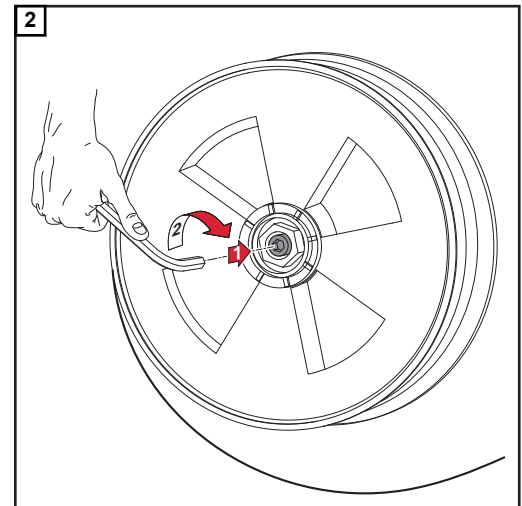
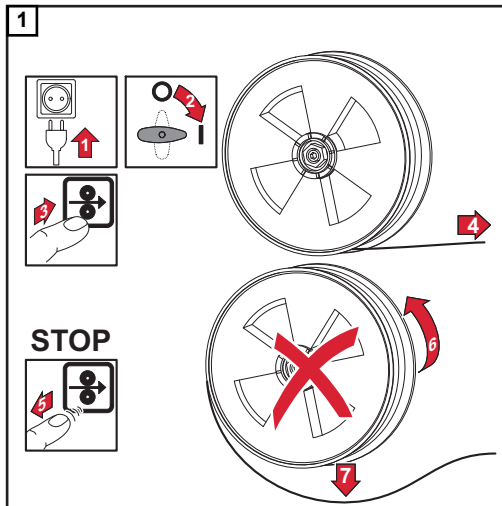

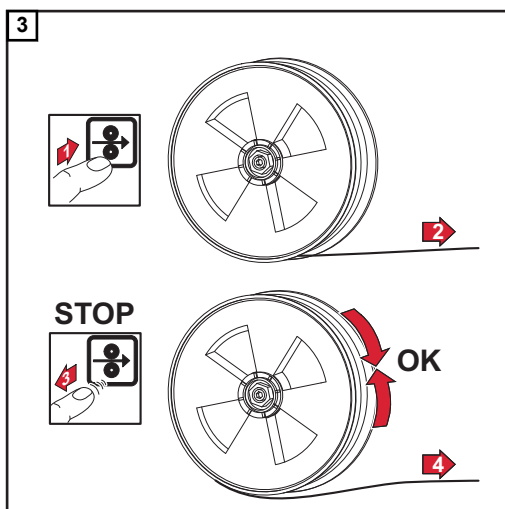

Design of the brake

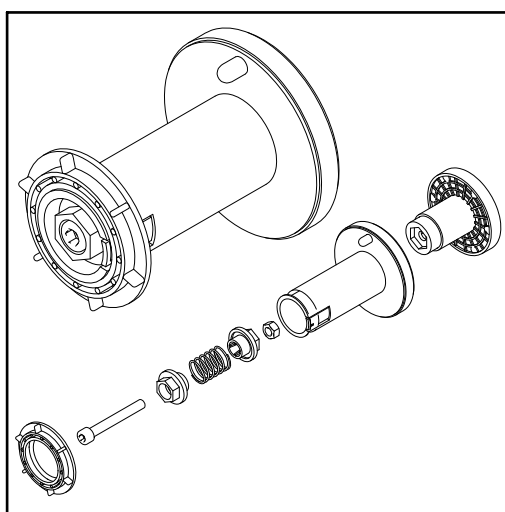

WARNING!

Danger from incorrect installation.

This can result in severe personal injury and damage to property.

- ▶ Do not dismantle the brake.
- ▶ Maintenance and servicing of brakes is to be carried out by trained, qualified personnel only.

The brake is only available as a complete unit.
This illustration is for information purposes only.

Performing R/L alignment

IMPORTANT! For optimum welding results, the manufacturer recommends performing an R/L alignment when starting the device for the first time and when any changes are made to the welding system.

More information about the R/L alignment can be found under "R/L alignment" in the "Process parameters" section of the "Welding mode" chapter (page [129](#)).

Locking and unlocking the power source using the NFC key

General remarks NFC key = NFC card or NFC key ring

The power source can be locked using an NFC key, e.g. to prevent unauthorised access or welding parameters being changed without permission.

A contactless system on the control panel allows the power source to be locked and unlocked.

The power source must be switched on before it can be locked or unlocked.

Locking and unlocking the power source using the NFC key

Locking the power source



1 Hold the NFC key on the NFC key reader

The key symbol appears on the display.

The key symbol is then displayed in the status bar.



The power source is now locked.
 Only the welding parameters can be viewed and adjusted using the adjusting dial.

Any attempt to call a locked function will result in a notification being displayed.

Unlocking the power source

- 1 Hold the NFC key on the NFC key reader

The crossed-out key symbol appears on the display.

The key symbol no longer appears in the status bar.
 All power source functions are now available again without restrictions.

NOTE!

More information about locking and unlocking the power source can be found in the "Defaults - Management / Administration" section from page 180.

Welding

MIG/MAG modes

General

WARNING!

Danger from incorrect operation.

Possible serious injury and damage to property.

- ▶ Do not use the functions described here until you have read and completely understood these Operating Instructions.
- ▶ Do not use the functions described here until you have fully read and understood all of the Operating Instructions for the system components, in particular the safety rules!

See the Setup menu for information on settings, setting range and units of measurement for the available parameters.

Symbols and their explanations

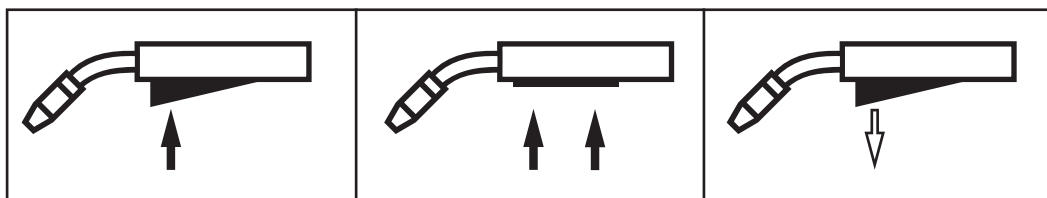

Press the torch trigger | Hold the torch trigger | Release the torch trigger

GPr

Gas pre-flow

I-S

Starting-current phase: the base material is heated up rapidly, despite the high thermal dissipation that occurs at the start of welding

t-S

Starting current time



Start arc length correction

SL1

Slope 1: the starting current is steadily lowered until it reaches the welding current

I

Welding-current phase: uniform thermal input into the base material, whose temperature is raised by the advancing heat

I-E

Final current phase: to prevent any local overheating of the base material due to heat build-up towards the end of welding. This eliminates any risk of weld seam drop-through.

t-E

Final current time



End arc length correction

SL2

Slope 2: the welding current is steadily lowered until it reaches the final current

GPo

Gas post-flow

A detailed explanation of the parameters can be found in the section headed "Process parameters"

2-step mode

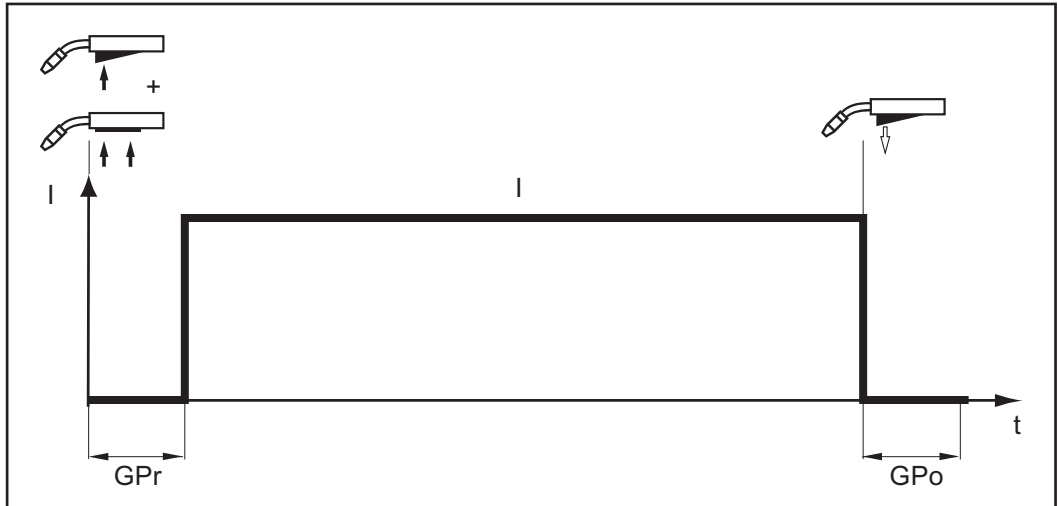

"2-step mode" is suitable for

- Tacking work
- Short weld seams
- Automated and robot welding

4-step mode

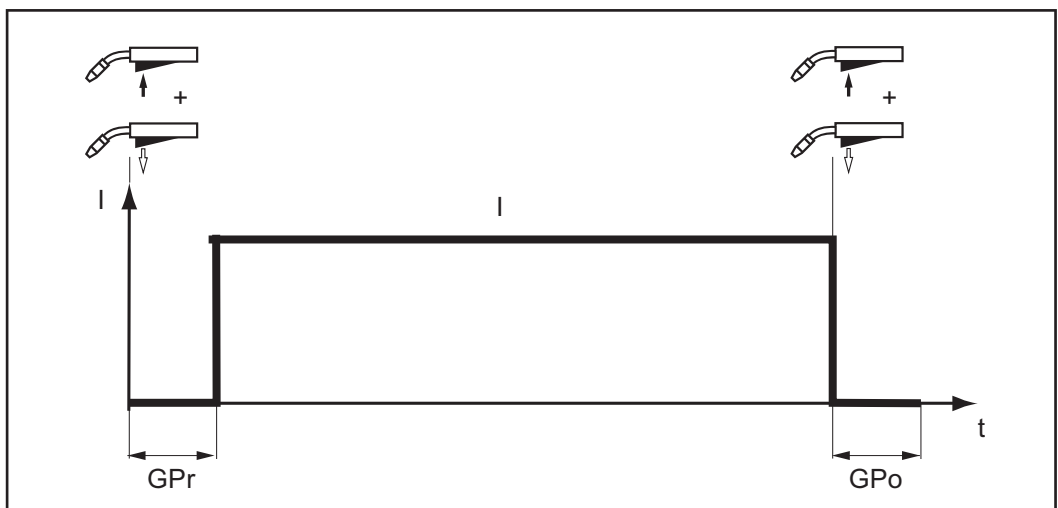

"4-step mode" is suitable for longer weld seams.

Special 4-step mode

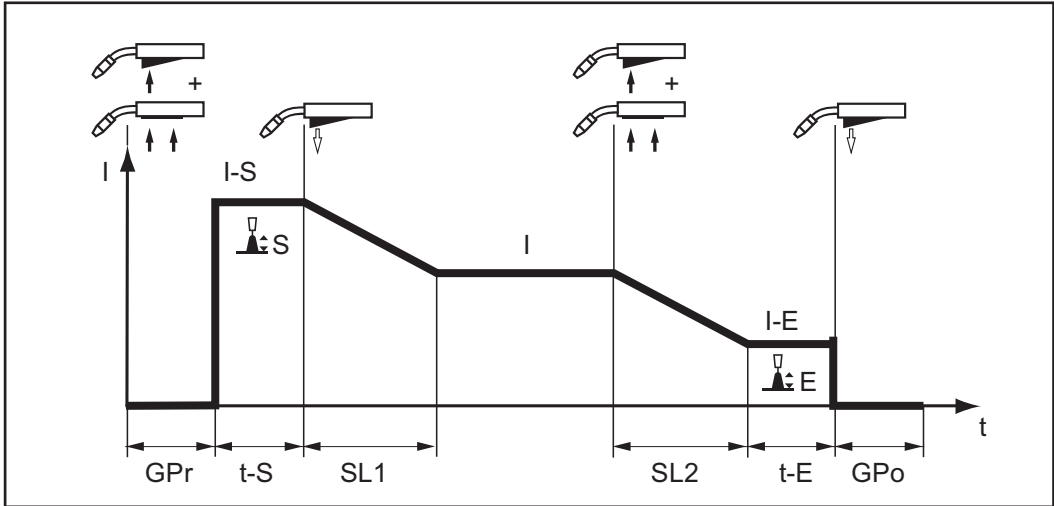

"Special 4-step mode" is particularly suitable for welding aluminium materials. The special slope of the welding current curve takes account of the high thermal conductivity of aluminium.

Special 2-step mode

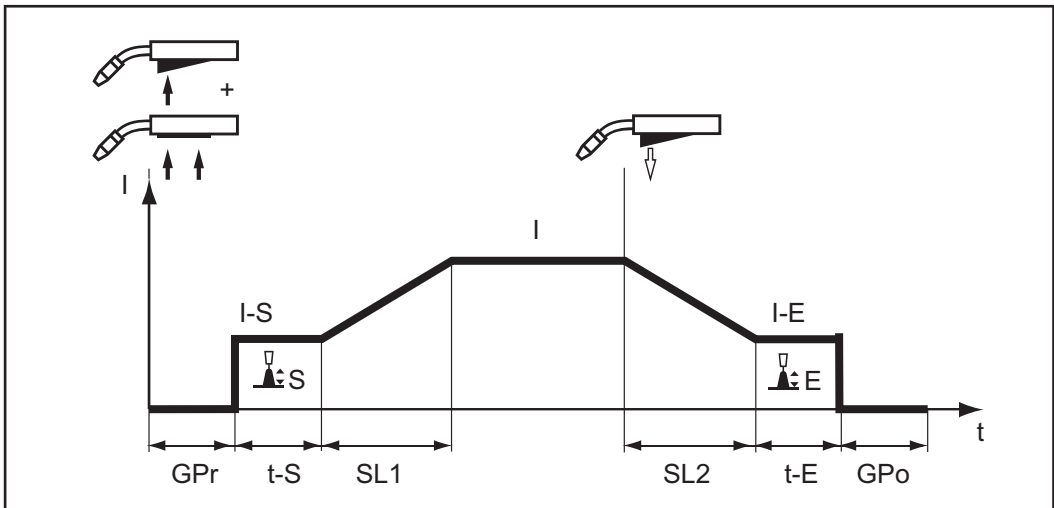

"Special 2-step mode" is ideal for welding in the higher power range. In special 2-step mode, the arc starts at a lower power, which makes it easier to stabilise.

Spot welding

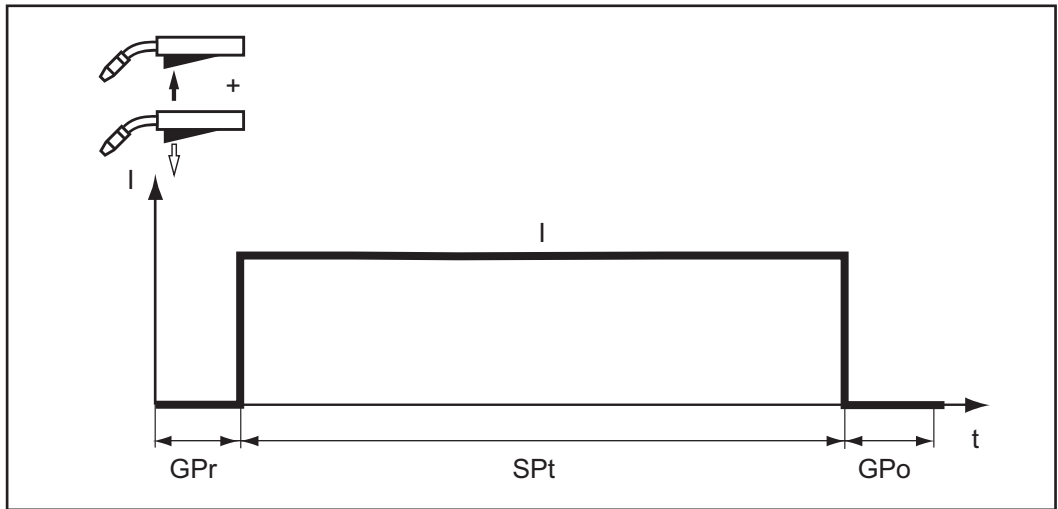

The "Spot welding" mode is suitable for welded joints on overlapped sheets.

MIG/MAG and CMT welding

Safety

WARNING!

Danger from incorrect operation.

Possible serious injury and damage to property.

- ▶ Do not use the functions described here until you have read and completely understood these Operating Instructions.
- ▶ Do not use the functions described here until you have fully read and understood all of the Operating Instructions for the system components, in particular the safety rules!

WARNING!

An electric shock can be fatal.

If the power source is connected to the mains electricity supply during installation, there is a high risk of very serious injury and damage.

- ▶ Before carrying out any work on the device make sure that the power source mains switch is in the "O" position
- ▶ Before carrying out any work on the device make sure that the power source is unplugged from the mains

MIG/MAG and CMT welding – overview

The "MIG/MAG and CMT welding" section comprises the following steps:

- Switching on the power source
- Selecting the welding process and operating mode
- Selecting the filler metal and shielding gas
- Setting the welding and process parameters
- Setting the shielding gas flow rate
- MIG/MAG or CMT welding

NOTE!

If using a cooling unit, follow the safety rules and note the operating conditions in the cooling unit Operating Instructions.

Switching on the power source

- 1** Connect the mains cable
- 2** Move the mains switch to the "I" position

A cooling unit connected to the system will begin to operate.

IMPORTANT! For optimum welding results, the manufacturer recommends performing an R/L alignment when starting the device for the first time and when any changes are made to the welding system.

More information about the R/L alignment can be found under "R/L alignment" in the "Process parameters" section of the "Welding mode" chapter (page [129](#)).

Setting the welding process and operating mode

Setting the welding process

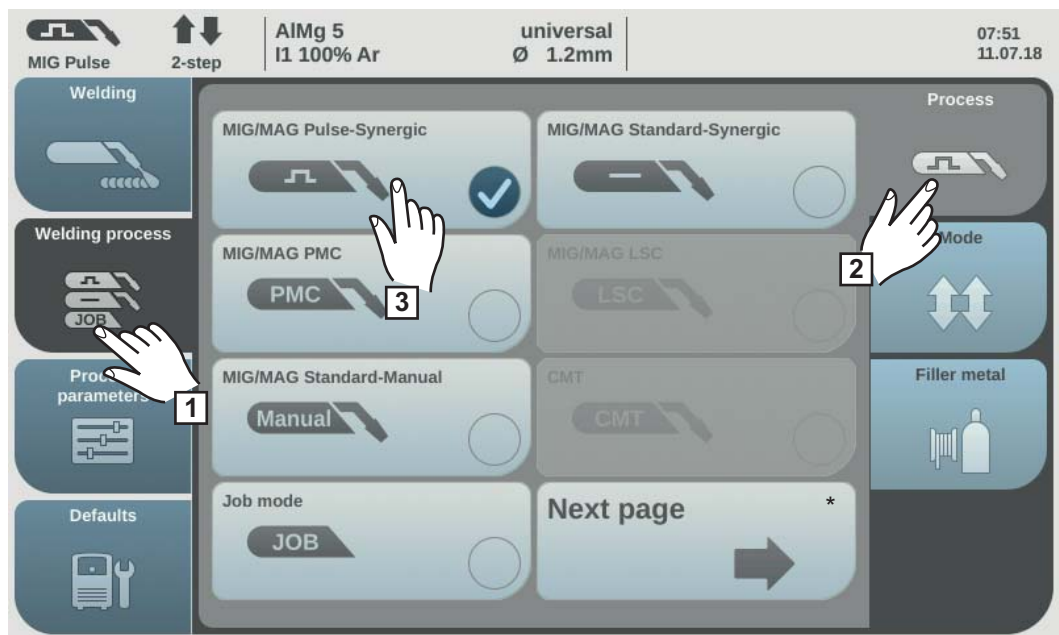

* next page: Electrode, TIG

1 Select "Welding process"

2 Select "Process"

An overview of the welding process is displayed.

Various welding processes are available depending on the power source type or function package installed.

3 Select the desired welding process

Setting the operating mode

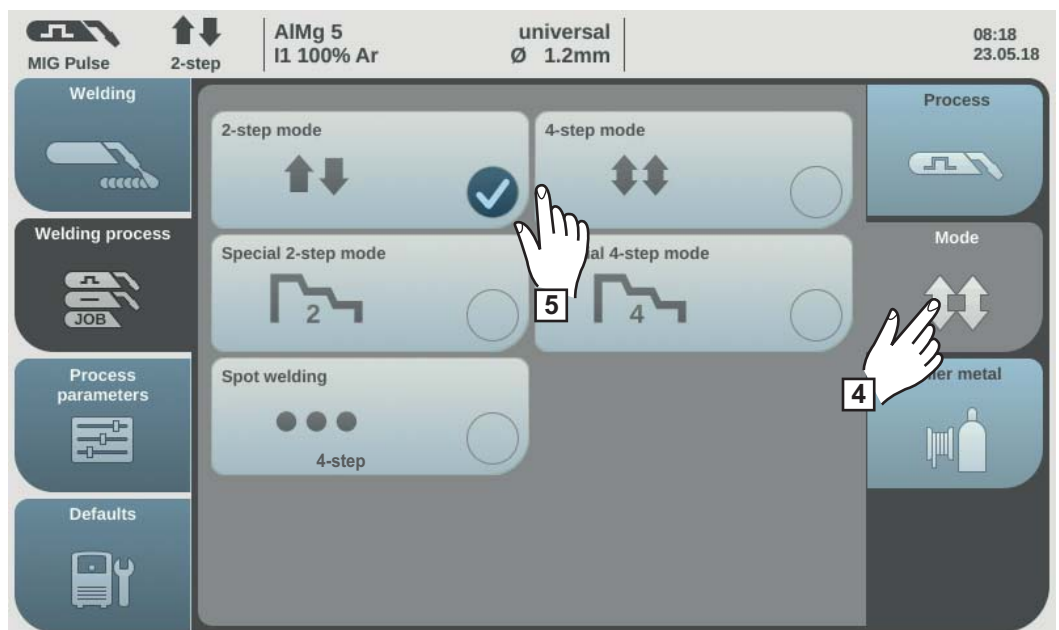

4 Select "Mode"

An overview of the operating modes is displayed:

- 2-step mode
- 4-step mode
- Special 2-step mode
- Special 4-step mode

5 Select the desired operating mode

Selecting the filler metal and shielding gas



- 1 Select "Welding process"
- 2 Select "Filler metal"
- 3 Select "Change material settings"
- 4 Turn the adjusting dial and select the desired filler metal
- 5 Select "Next" / press the adjusting dial
- 6 Turn the adjusting dial and select the desired wire diameter
- 7 Select "Next" / press the adjusting dial
- 8 Turn the adjusting dial and select the desired shielding gas
- 9 Select "Next" / press the adjusting dial

NOTE!

The available characteristics per welding process are not displayed if only one characteristic is available for the selected filler metal.

In this case, the confirmation step of the filler metal wizard follows immediately; steps 10 - 14 do not apply.

- 10 Turn the adjusting dial and select the desired welding process
- 11 To select the desired characteristic, press the adjusting dial (blue background)
- 12 Turn the adjusting dial and select the desired characteristic
- 13 Press the adjusting dial and apply the selected characteristic (white background)
- 14 Select "Next"

The confirmation step of the filler metal wizard is displayed:

- 15 Select "Save" / press the adjusting dial

The selected filler metal and associated characteristics per welding process will be saved.

Setting the welding parameters



- 1 Select "Welding"
- 2 Select the desired welding parameter by turning the adjusting dial
- 3 Press the adjusting dial to change the welding parameter

The value of the welding parameter is displayed as a horizontal scale:

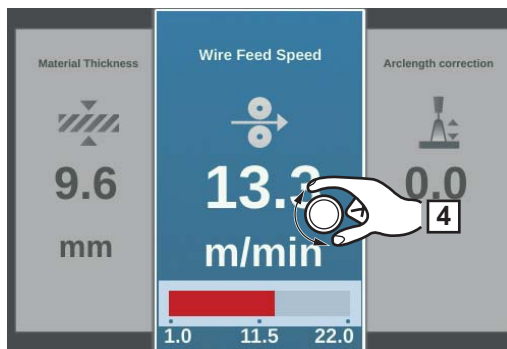

e.g. wire speed parameter

The value of the selected parameter can now be changed.

- 4 Turn the adjusting dial to change the welding parameter

The adjusted value of the welding parameter is applied immediately. If one of the "Wire speed", "Material thickness", "Current" or "Voltage" parameters is changed during synergic welding, the other welding parameters are immediately adjusted accordingly.

- 5 Press the adjusting dial to call up the welding parameters overview
- 6 Adjust the process parameters accordingly to make user- or application-specific settings on the welding system

Setting the shielding gas flow rate

- 1 Open the gas cylinder valve
- 2 Press the gas test button

Shielding gas flows out

- 3 Turn the adjusting screw on the underside of the pressure regulator until the pressure gauge shows the required shielding gas flow rate
- 4 Press the gas test button

The flow of gas stops.

MIG/MAG or CMT welding



- 1 Select "Welding" to display the welding parameters

CAUTION!

Risk of injury and damage from electric shock and from the wire electrode emerging from the torch.

When pressing the torch trigger:

- ▶ keep the torch away from your face and body
- ▶ do not point the welding torch at people
- ▶ make sure that the wire electrode does not touch any electrically conducting or earthed (grounded) parts, such as the housing, etc.

- 2 Press the torch trigger and start welding

Whenever welding ends, the actual values for the welding current, welding voltage and wire speed are stored, and HOLD appears on the display.

NOTE!

Parameters that have been set on a system component control panel (e.g. wire feed unit or remote control) might not be able to be changed on the power source control panel.

MIG/MAG and CMT welding parameters

Welding parameters for MIG/MAG pulse synergic welding, for CMT welding and PMC welding

The following welding parameters for MIG/MAG pulse synergic welding, CMT welding and PMC welding can be set and displayed by pressing the "Welding" button:

Current ¹⁾ [A]

Setting range: depends on the welding process and welding program selected

Before the start of welding, the machine automatically displays a standard value based on the programmed parameters. The actual value is displayed during welding.

Voltage ¹⁾ [V]

Setting range: depends on the welding process and welding program selected

Before the start of welding, the machine automatically displays a standard value based on the programmed parameters. The actual value is displayed during welding.

Material thickness ¹⁾

0.1 - 30.0 mm ²⁾ / 0.004 - 1.18 ²⁾ in.

Wire speed ¹⁾

0.5 - max. ^{2) 3)} m/min / 19.69 - max ^{2) 3)} ipm.

Arc length correction

for correcting the arc length;

-10 - +10

Factory setting: 0

- ... shorter arc length

0 ... neutral arc length

+ ... longer arc length

Pulse/dynamic correction

for correcting the pulsing energy of a pulsed arc

-10 - +10

Factory setting: 0

- ... lower droplet detachment force

0 ... neutral droplet detachment force

+ ... increased droplet detachment force

Welding parameters for MIG/MAG standard synergic welding and LSC welding

The following welding parameters for MIG/MAG standard synergic welding and LSC welding can be set and displayed by selecting the "Welding" menu button:

Current ¹⁾ [A]

Setting range: depends on the welding process and welding program selected

Before the start of welding, the machine automatically displays a standard value based on the programmed parameters. The actual value is displayed during welding.

Voltage ¹⁾ [V]

Setting range: depends on the welding process and welding program selected

Before the start of welding, the machine automatically displays a standard value based on the programmed parameters. The actual value is displayed during welding.

Material thickness ¹⁾

0.1 - 30.0 mm ²⁾ / 0.004 - 1.18 ²⁾ in.

Wire speed ¹⁾

0.5 - max. ^{2) 3)} m/min / 19.69 - max ^{2) 3)} ipm.

Arc length correction

for correcting the arc length;

-10 - +10

Factory setting: 0

- ... shorter arc length

0 ... neutral arc length

+ ... longer arc length

Pulse/dynamic correction

for correcting the pulsing energy of a pulsed arc

-10 - +10

Factory setting: 0

- ... lower droplet detachment force

0 ... neutral droplet detachment force

+ ... increased droplet detachment force

Welding parameters for MIG/MAG standard manual welding

The following welding parameters for MIG/MAG standard manual welding can be set and displayed by selecting the "Welding" menu button:

Voltage ¹⁾ [V]

Setting range: depends on the welding process and welding program selected

Before the start of welding, the machine automatically displays a standard value based on the programmed parameters. The actual value is displayed during welding.

Arc-force dynamic

to influence the short-circuiting dynamic at the instant of droplet transfer

0 - 10

Factory setting: 0

0 ... harder and more stable arc

10 ... soft and low-spatter arc

Wire speed ¹⁾

for setting a harder, more stable arc

0.5 - max. ²⁾ m/min / 19.69 - max ²⁾ ipm.

Explanation of footnotes

- 1) Synergic parameter
When a synergic parameter is changed, the synergic function automatically changes all other synergic parameters to match.

The real setting range depends on power source and wire feeder used and on the welding program.

- 2) The real setting range depends on the welding program.
3) The maximum value depends on the wire feeder used.

EasyJob mode

General

If EasyJob mode has been activated, 5 additional buttons appear on the display. These enable up to 5 operating points to be saved at the touch of a button. The current welding settings are saved.

Activating Easy-Job mode

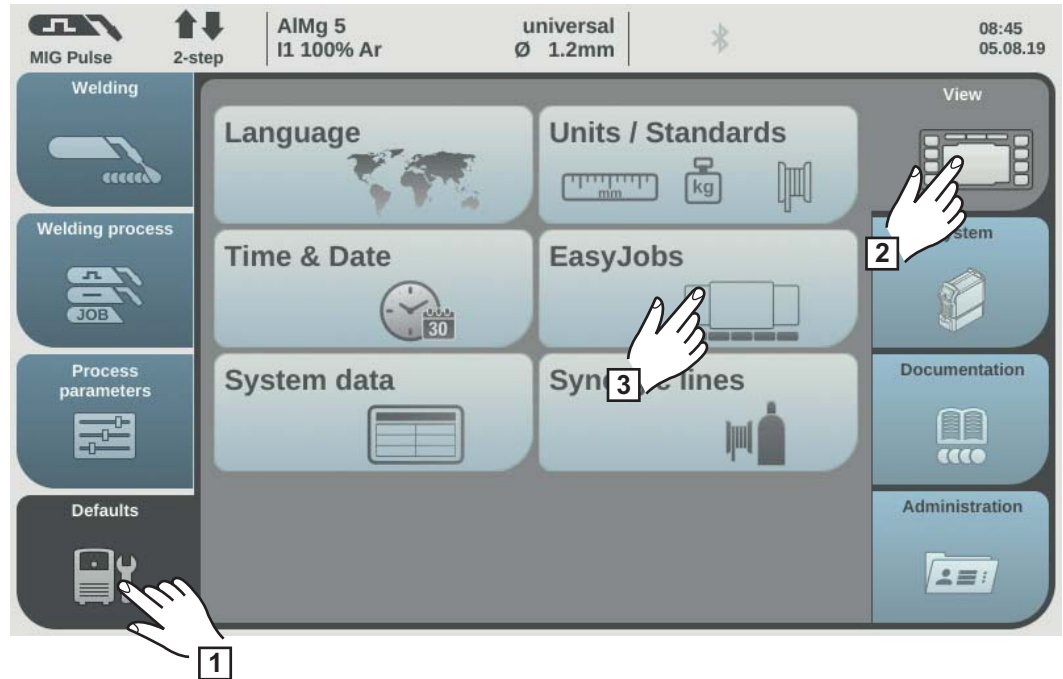

- 1 Select "Defaults"
- 2 Select "View"
- 3 Select "EasyJobs"

The overview to activate/deactivate EasyJob mode is displayed.

- 4 Select "EasyJobs on"
- 5 Select "OK"

EasyJob mode is activated and the default settings are displayed.

- 6 Select "Welding"

Five "EasyJob" buttons are displayed for the welding parameters.

Storing EasyJob operating points

NOTE!

The EasyJobs are stored under job numbers 1 - 5 and can also be retrieved using "Job mode".

Storing an EasyJob overwrites any other job saved under the same number!

- 1 To store the current welding settings, touch one of the EasyJob buttons for about three seconds

The size and colour of the button changes. After about three seconds, the button is displayed green with a frame.

The settings have now been stored. The most recently stored settings will be active. An active EasyJob is displayed with a tick on the EasyJob button. Unused EasyJob buttons are displayed in dark grey.

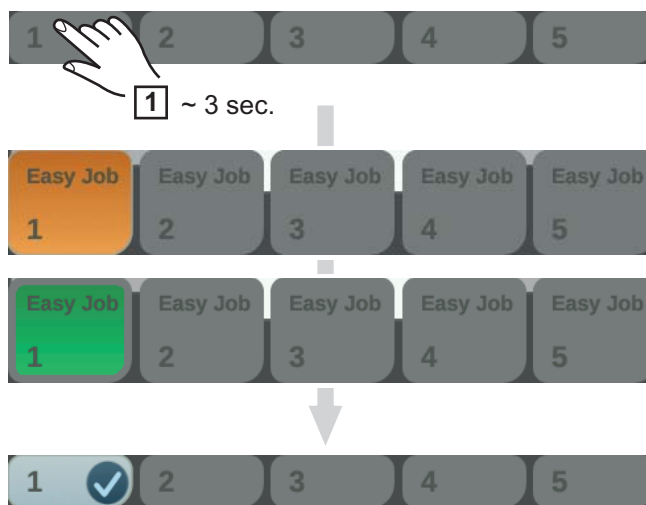

Retrieving Easy-Job operating points

- 1 To retrieve a saved EasyJob operating point, touch the corresponding EasyJob button briefly (< 3 seconds)

The size and colour of the button changes briefly; it is then displayed with a tick.



If a tick is not displayed after touching an EasyJob button, this means that there is no operating point saved under this button.

Deleting EasyJob operating points

- To delete an EasyJob operating point, touch the relevant EasyJob button for approximately 5 seconds

The button

- First changes its size and colour;
- Is displayed with a frame after about 3 seconds;
- The saved operating point is overwritten with the current settings.
- Is highlighted in red (= delete) after a total of 5 seconds.

The EasyJob operating point has been deleted.

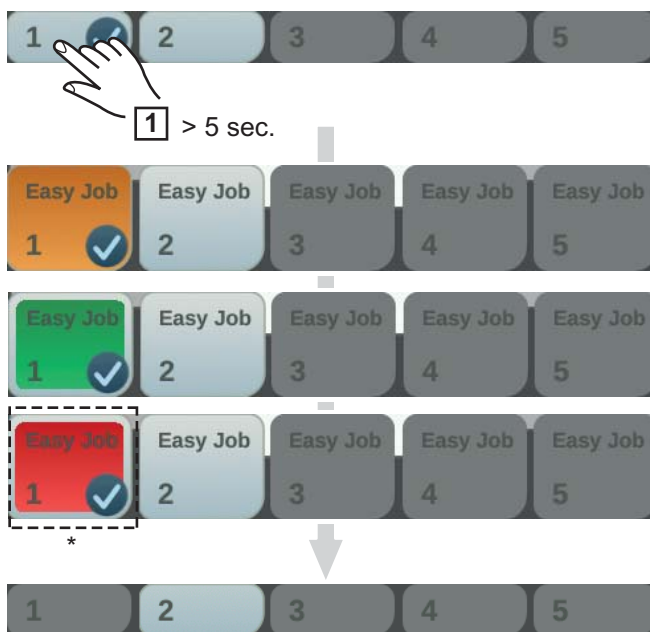

* ... highlighted in red

Job mode

General

Up to 1000 jobs can be stored and retrieved in the power source. This eliminates the need for manual documenting of the welding parameters. "Job mode" enhances the quality of automated and manual applications.

Jobs can only be stored when in welding mode. When storing jobs, the process parameters and certain machine defaults are taken into account in addition to the present welding settings.

Storing settings as a job

- 1 Set the parameters that are to be stored as a job:
 - Welding parameters
 - Welding process
 - Process parameters
 - Machine defaults (if necessary)



- 2 Select "Save as Job"

The job list is displayed.

To overwrite an existing job, select it by turning and pressing the adjusting dial (or selecting "Next").

The selected job can be overwritten after acknowledging the confirmation prompt.

Select "Create a new Job" to create a new job

- 3 Press the adjusting dial / select "Next"

The next free job number is displayed.

- 4 Turn the adjusting dial and select the desired storage location

- 5 Press the adjusting dial / select "Next"

The keyboard is displayed.

- 6 Enter a job name
- 7 Select "OK" and confirm the job name / press the adjusting dial

The name is saved and a confirmation that the job has been stored is displayed.

- 8 To exit, select "Finish" / press the adjusting dial

Job welding - retrieving a job

NOTE!

Before retrieving a job, make sure that the welding system has been installed and set up for the job.

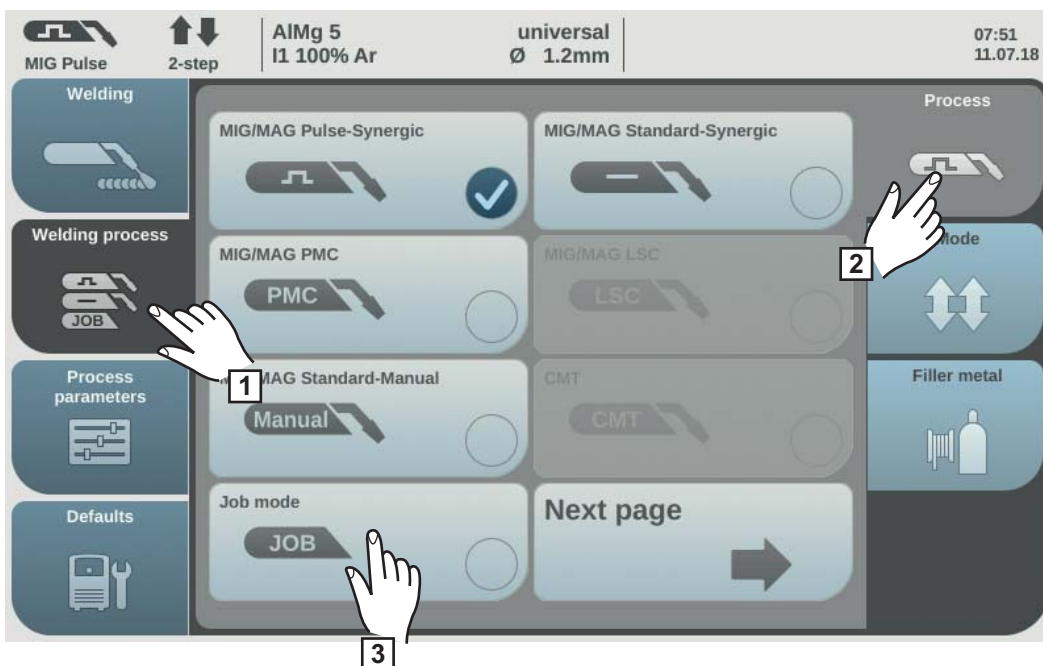

- 1 Select "Welding process"
- 2 Select "Process"
- 3 Select "Job mode"

Job mode is activated.

"Job welding" and the data from the most recently retrieved job are displayed.

- 4 Select "Job welding"
- 5 Turn the adjusting dial and select "Job number" (white background)
- 6 To select the desired job, press the adjusting dial (blue background)
- 7 Turn the adjusting dial to select the desired job number (blue background)
The name of the selected job is displayed above the actual value display.
- 8 Press the adjusting dial and accept the selected job number (white background)
- 9 Start welding

IMPORTANT! "Job number" is the only parameter that can be altered in Job mode; all the others are read-only.

Renaming a job



- 1 Select "Save as Job"
(also works in Job mode)

The job list is displayed.

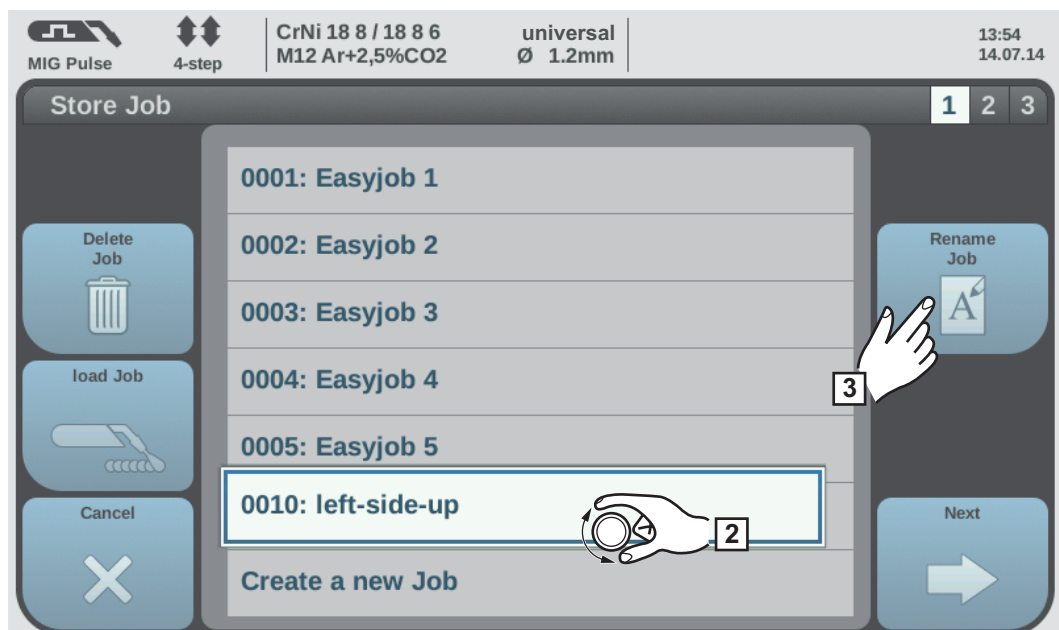

- 2 Turn the adjusting dial and select the job to be renamed
- 3 Select "Rename Job"

The keyboard is displayed.

- 4 Change the job name using the keyboard
- 5 Select "OK" and confirm the amended job name / press the adjusting dial

The job name is changed and the job list is displayed.

- 6 To exit, select "Cancel"

Deleting a job



- 1 Select "Save as Job"
(also works in Job mode)

The job list is displayed.

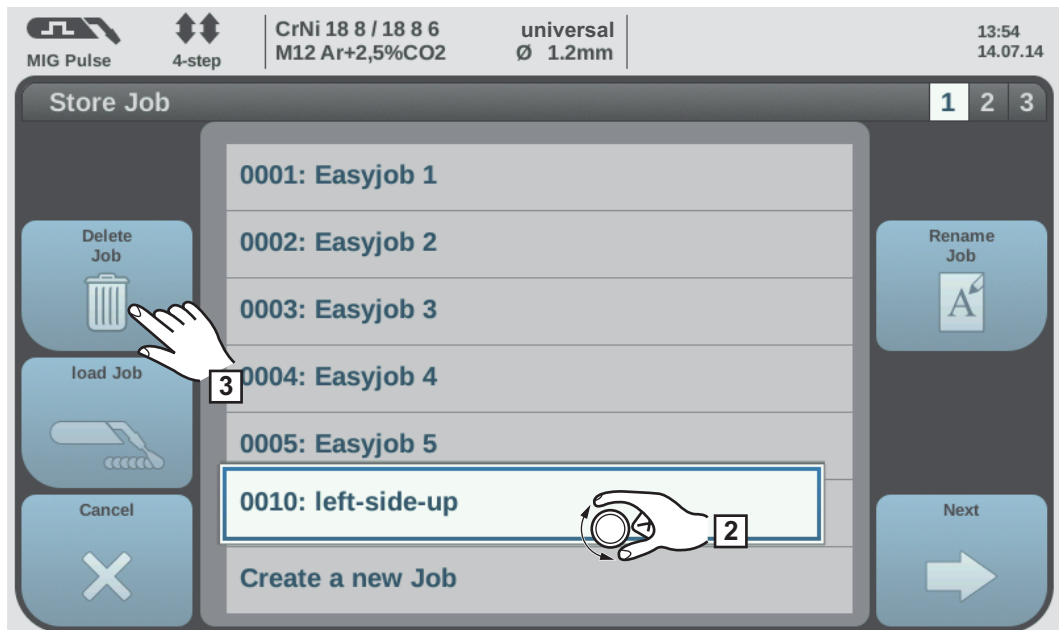

- 2 Turn the adjusting dial and select the job to be deleted
- 3 Select "Delete Job"

A confirmation prompt asking whether you really want to delete the job is displayed.

- 4 Select "Yes" to delete the selected job

The job is deleted, the job list is displayed.

- 5 To exit, select "Cancel"

Loading a job

The load job function can be used to load the data for a saved job or an EasyJob to the welding screen. The relevant data from the job is displayed in the welding parameters and can be changed, saved as a new job or EasyJob, or used to start welding.

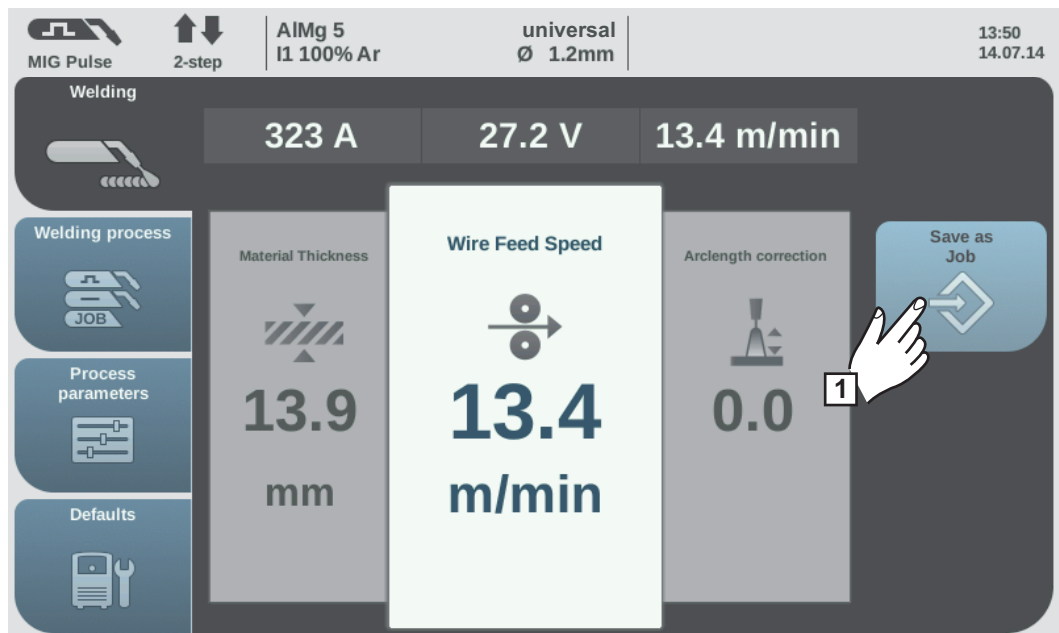

- 1 Select "Save as Job"
(also works in Job mode)

The job list is displayed.

- 2 Turn the adjusting dial and select the job to be loaded
- 3 Select "load Job"

The load job information is shown.

- 4 Select "Yes"

The data for the selected job is loaded onto the welding screen.

The data for the loaded job can now be used for welding (no job mode), changed, or be saved as a new job or an EasyJob.

Optimize job

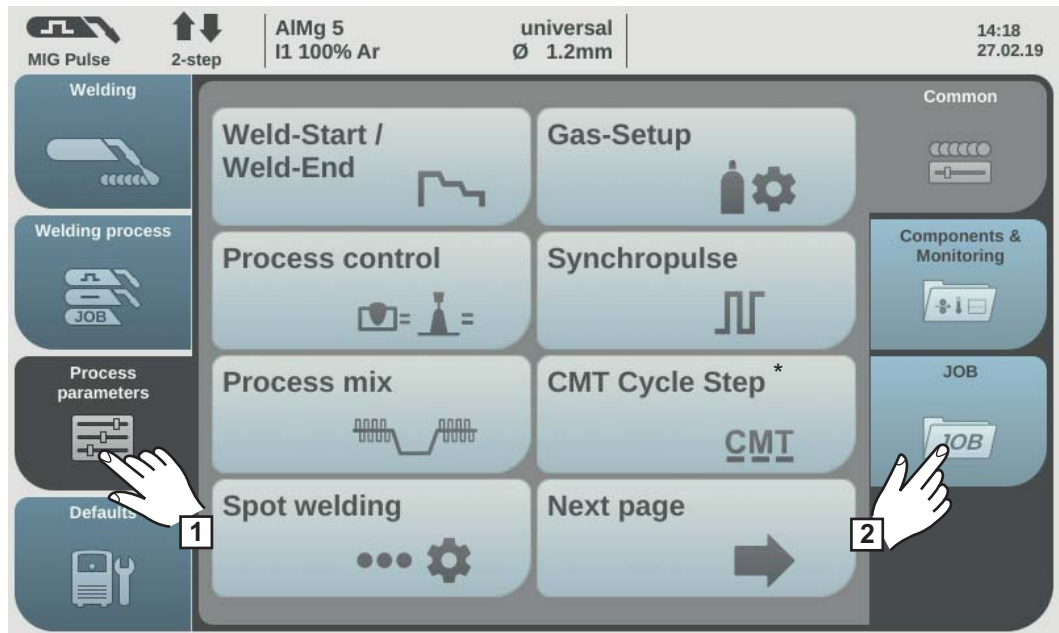

* Only displayed if the OPT/i CMT Cycle Step option is present on the power source. In TWIN mode, the TWIN process control button is displayed after the "Process mix" button.

- 1 Select "Process parameters"
- 2 Select "JOB"

An overview of the job functions is displayed.

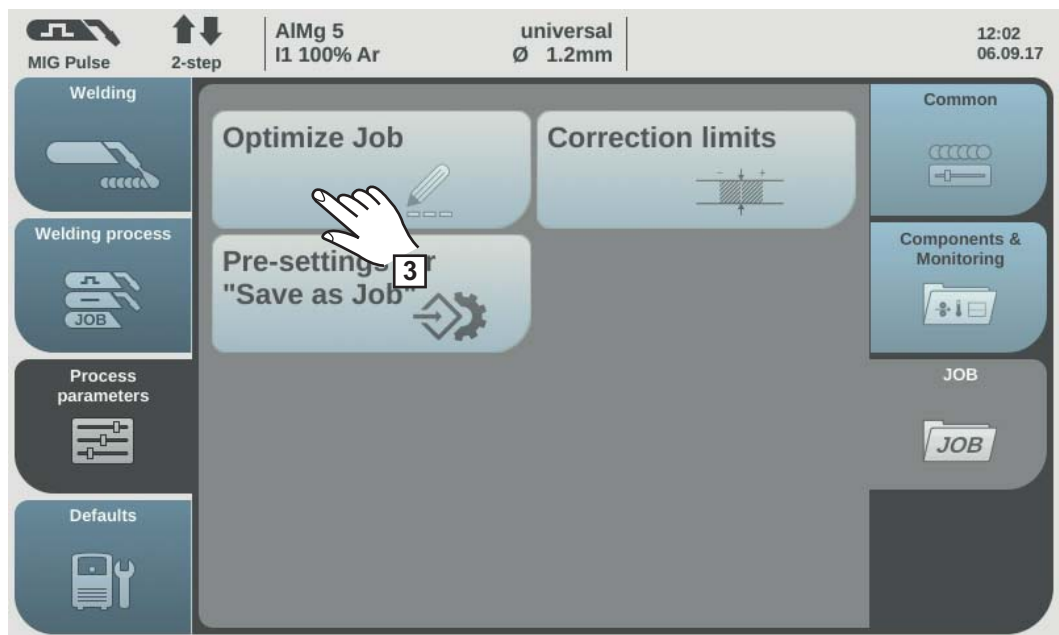

- 3 Select "Optimize Job"

The overview of the most recently optimised job is displayed.

- 4 Turn the adjusting dial and select either the job or the job welding parameters to be modified

The choice between the job and the job welding parameters can also be made by touching the "Job number / Job parameter" button.



Select job:

- Press the adjusting dial

The job number is highlighted in blue and can now be changed.

- Turn the adjusting dial to select the job to be altered
- Press the adjusting dial to change the job

Select job welding parameters:

- Turn the adjusting dial and select the parameter to be changed
- Press the adjusting dial

The value of the parameter is highlighted in blue and can now be changed.

- Turn the adjusting dial; the amended value is applied immediately
- Press the adjusting dial to select other parameters

- 5 Select "Finish"

Setting correction limits for a job

Individual correction limits for welding power and arc length can be defined for each job. If correction limits are defined for a job, the welding power and arc length for the job in question can be corrected within the defined limits while welding.

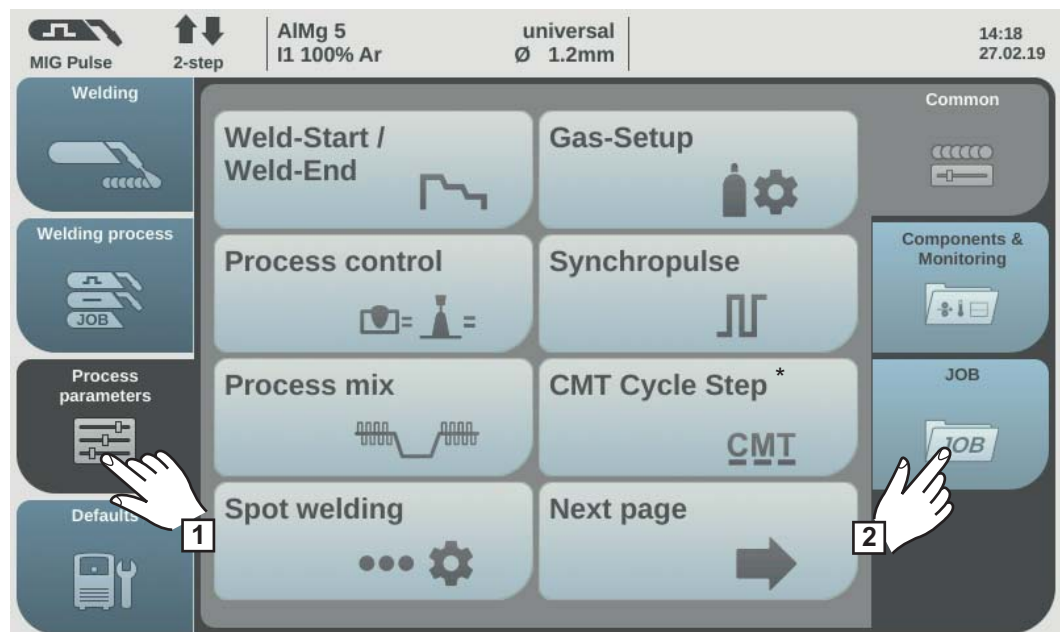

* Only displayed if the OPT/i CMT Cycle Step option is present on the power source. In TWIN mode, the TWIN process control button is displayed after the "Process mix" button.

- 1 Select "Process parameters"

2 Select "JOB"

An overview of the job functions is displayed.

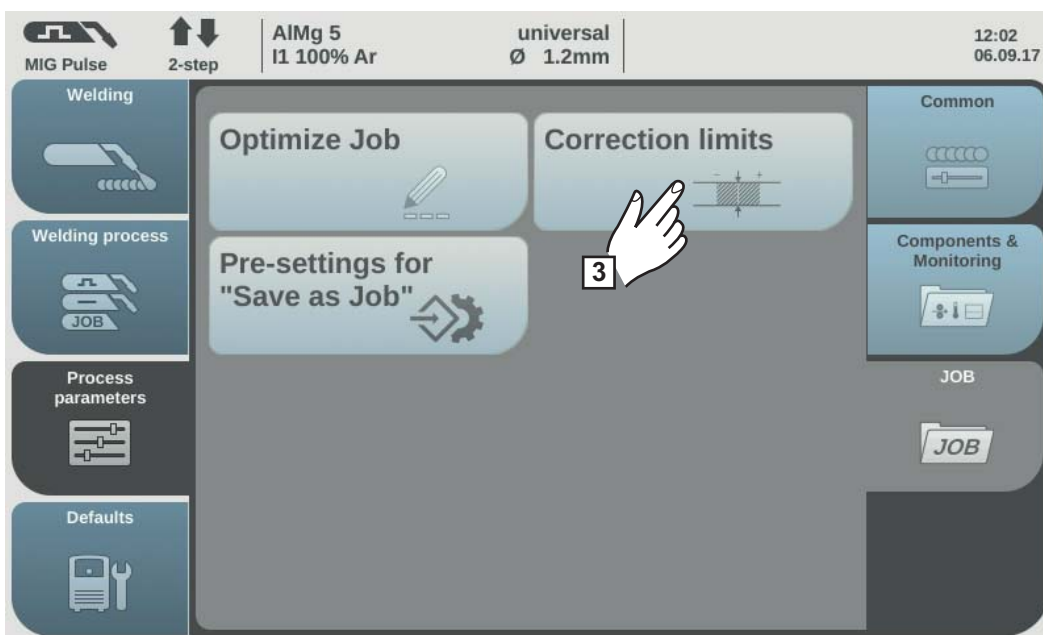

3 Select "Correction limits"

A list of the job correction limits for the last job opened is displayed.

4 Turn the adjusting dial and select either the job or the job limits to be modified

The choice between the job and the job limits can also be made by touching the "Job number / Job parameter" button.



Select job:

- Press the adjusting dial

The job number is highlighted in blue and can now be changed.

- Turn the adjusting dial to select the job to be altered
- Press the adjusting dial to change the job

Select job limits:

- Turn the adjusting dial and select the desired limit group
- Press the adjusting dial

The selected limit group opens.

- Turn the adjusting dial and select the top or bottom limit
- Press the adjusting dial

The value of the limit parameter is highlighted in blue and can now be changed.

- Turn the adjusting dial; the amended value is applied immediately
- Press the adjusting dial to select other limit parameters

- 5 Select "Finish"

Pre-settings for "Save as Job"

Pre-settings for "Save as Job" are used to set the default values that are assumed for every newly created job.

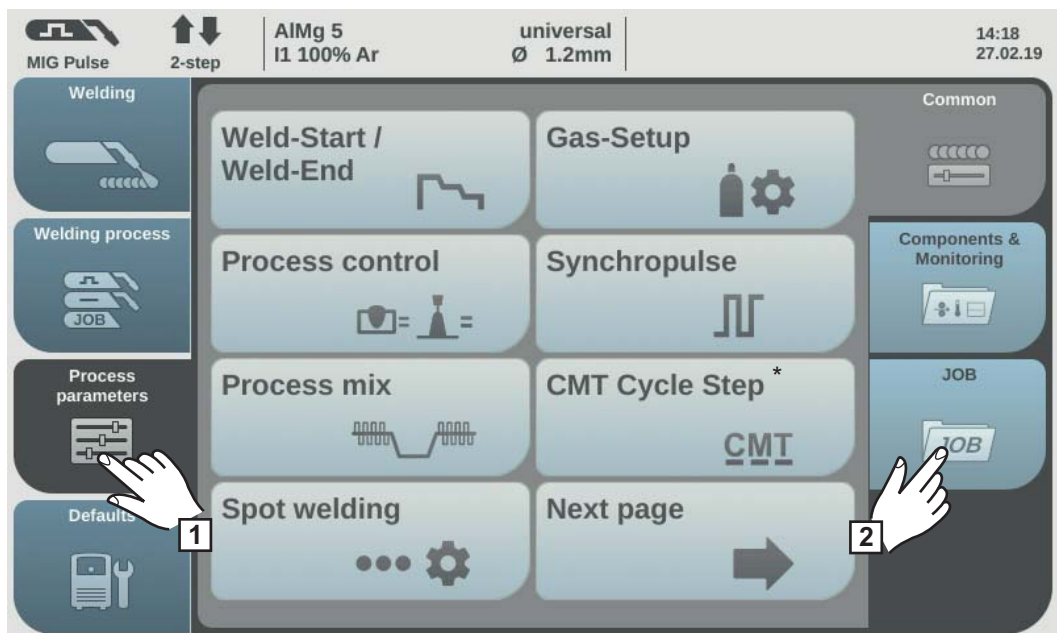

* Only displayed if the OPT/i CMT Cycle Step option is present on the power source. In TWIN mode, the TWIN process control button is displayed after the "Process mix" button.

- 1 Select "Process parameters"
- 2 Select "JOB"

An overview of the job functions is displayed.

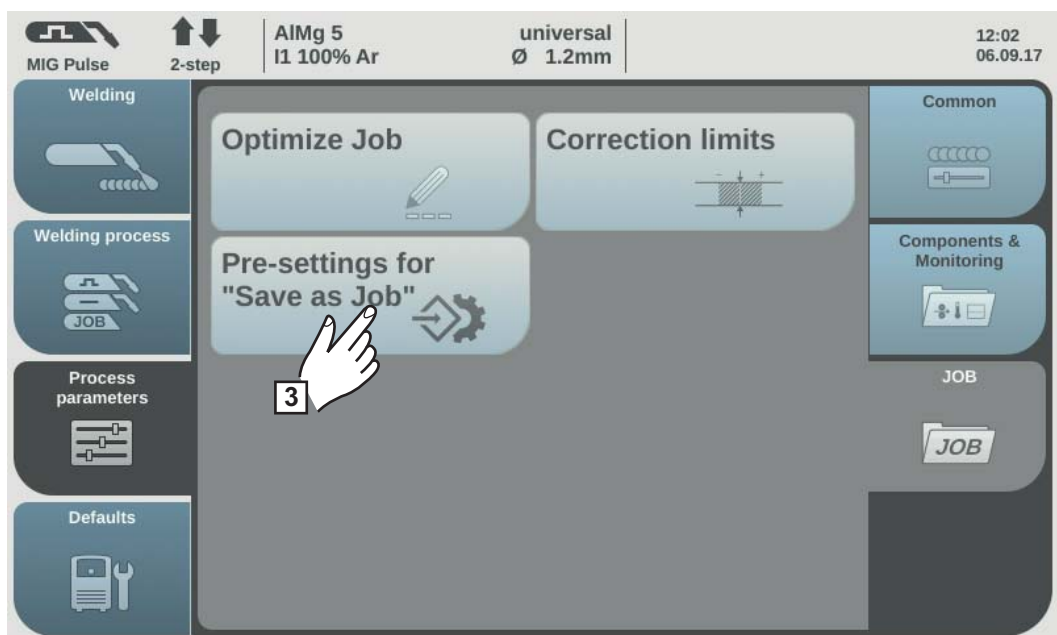

- 3 Select "Pre-settings for "Save as Job""
- 4 Confirm the displayed information

The default settings for saving new jobs are displayed.

- 5 Turn the adjusting dial and select the desired parameter
- 6 Press the adjusting dial
- 7 Turn the adjusting dial and change the value
- 8 Press the adjusting dial
- 9 Select "Finish"

Spot welding

Spot welding

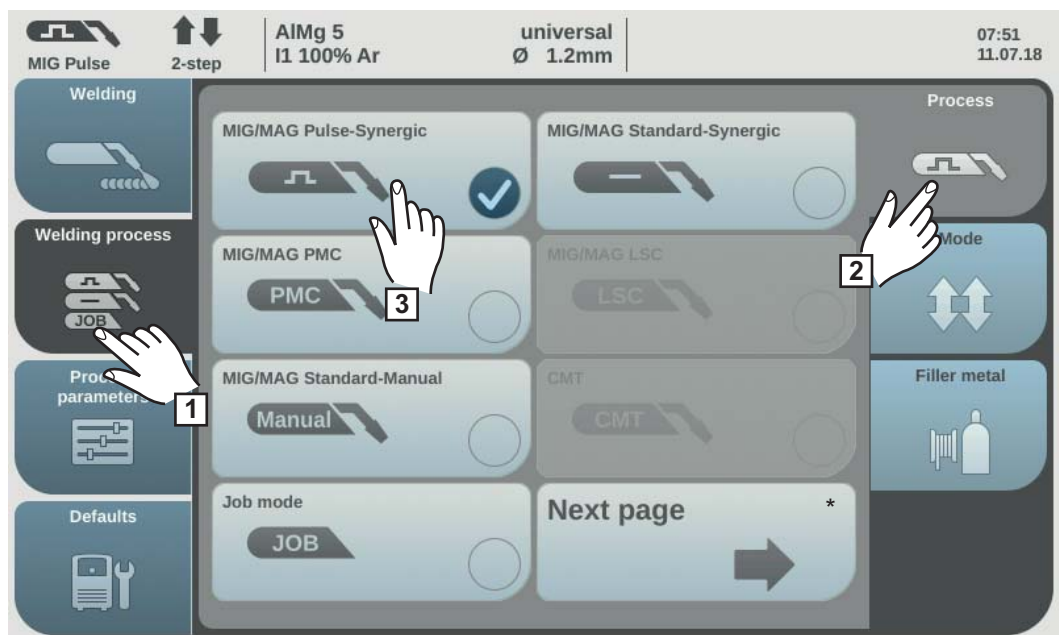

- 1 Select "Welding process"
- 2 Select "Process"
- 3 Select the desired welding process

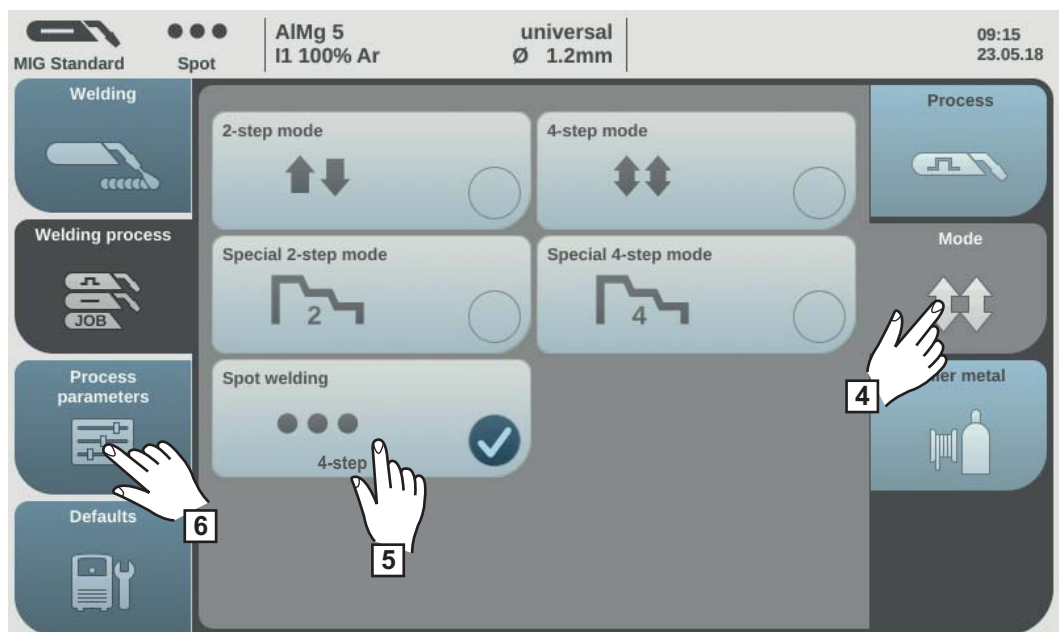

- 4 Select "Mode"
- 5 Select "Spot welding"
- 6 Select "Process parameters"

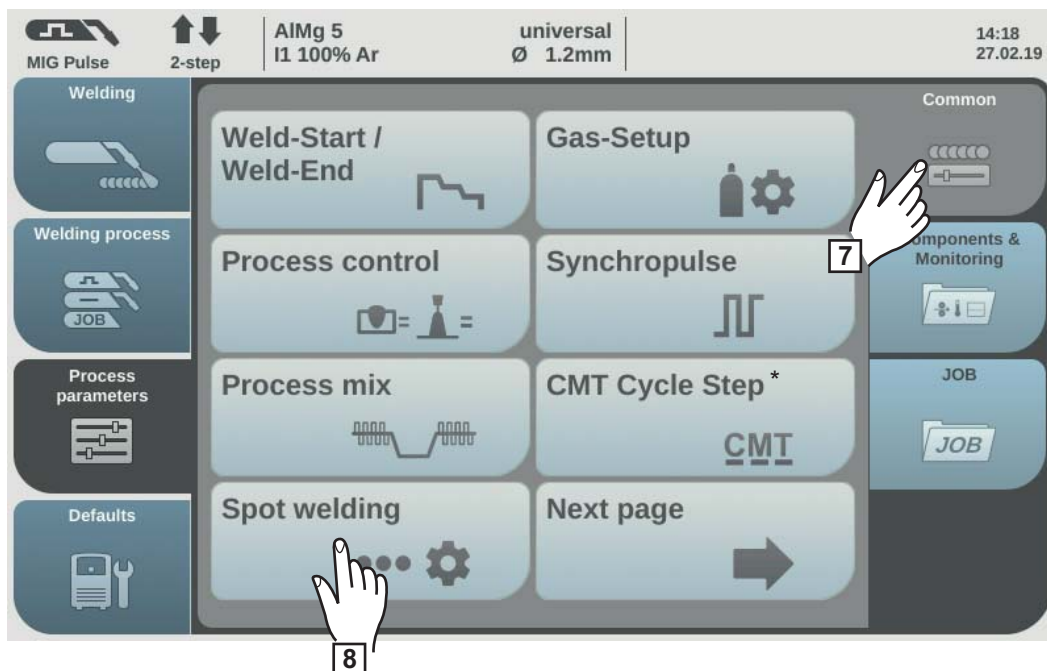

* Only displayed if the OPT/i CMT Cycle Step option is present on the power source. In TWIN mode, the "TWIN process control" button is displayed after the "Process mix" button. In this case, the "Spot welding" button is on the next page.

- 7 Select "Common"
- 8 Select "Spot welding"

The spot welding time parameter is displayed.

- 9 Enter the desired value for the spot welding time: Press and turn the adjusting dial
 Setting range: 0.1 - 10.0 s
 Factory setting: 1.0 s
- 10 Apply value by pressing OK

NOTE!

4-step mode is assigned as standard for spot welding.

Press the torch trigger - Spot welding process runs until the end of the spot welding time
 - Press again to stop the spot welding time prematurely

- The spot welding parameter can be changed to 2-step under Defaults / System / Mode Setup
 (more information on 2-step and 4-step mode in spot welding starts on page 165)

- 11 Select the filler metal, wire diameter and shielding gas
- 12 Open the gas cylinder valve
- 13 Set the shielding gas flow rate

 **CAUTION!**

Risk of injury and damage from electric shock and from the wire electrode emerging from the torch.

When pressing the torch trigger:

- ▶ Keep the welding torch away from your face and body
 - ▶ Wear suitable protective goggles
 - ▶ Do not point the welding torch at people
 - ▶ Make sure that the wire electrode does not touch any conductive or earthed parts (e.g. housing, etc.)
-

14 Spot welding

Procedure for producing a welding spot:

- 1** Hold the welding torch vertical
- 2** Press and release the torch trigger
- 3** Keep the torch in the same position
- 4** Wait for the gas post-flow time
- 5** Lift the torch off the workpiece

NOTE!

Pre-set start of welding and end of welding parameters are also active for spot welding.

- ▶ Start of welding / end of welding treatment for spot welding can be assigned under Process parameters / General / Weld-Start, Weld-End.
 - ▶ If the final current time is active, the end of welding is not after the pre-set spot welding time, but only once the pre-set slope and final current times have ended.
-

Safety

WARNING!

Danger from incorrect operation.

Possible serious injury and damage to property.

- ▶ Do not use the functions described here until you have read and completely understood these Operating Instructions.
- ▶ Do not use the functions described here until you have fully read and understood all of the Operating Instructions for the system components, in particular the safety rules!

WARNING!

An electric shock can be fatal.

If the power source is connected to the mains electricity supply during installation, there is a high risk of very serious injury and damage.

- ▶ Before carrying out any work on the device make sure that the power source mains switch is in the "O" position
- ▶ Before carrying out any work on the device make sure that the power source is unplugged from the mains

Preparations

- 1 Move the mains switch to the "O" position
- 2 Disconnect the mains plug
- 3 Remove the MIG/MAG welding torch
- 4 Disconnect the grounding (earthing) cable from the (-) current socket
- 5 Plug the grounding (earthing) cable into the 2nd (+) current socket and twist to fasten it
- 6 Use the other end of the grounding (earthing) cable to establish a connection to the workpiece
- 7 Plug the bayonet current plug on the TIG gas-valve torch into the (-) current socket and twist it clockwise to fasten it
- 8 Screw the pressure regulator onto the (argon) gas cylinder and tighten it
- 9 Connect the gas hose of the TIG gas-valve torch to the pressure regulator
- 10 Plug in the mains plug

⚠ CAUTION!

Risk of injury and damage from electric shock.

As soon as the mains switch is in the "I" position, the tungsten electrode of the welding torch is live.

- ▶ Ensure that the tungsten electrode does not touch any persons or electrically conductive or earthed parts (e.g. housing, etc.).

- 1 Move the mains switch to the "I" position

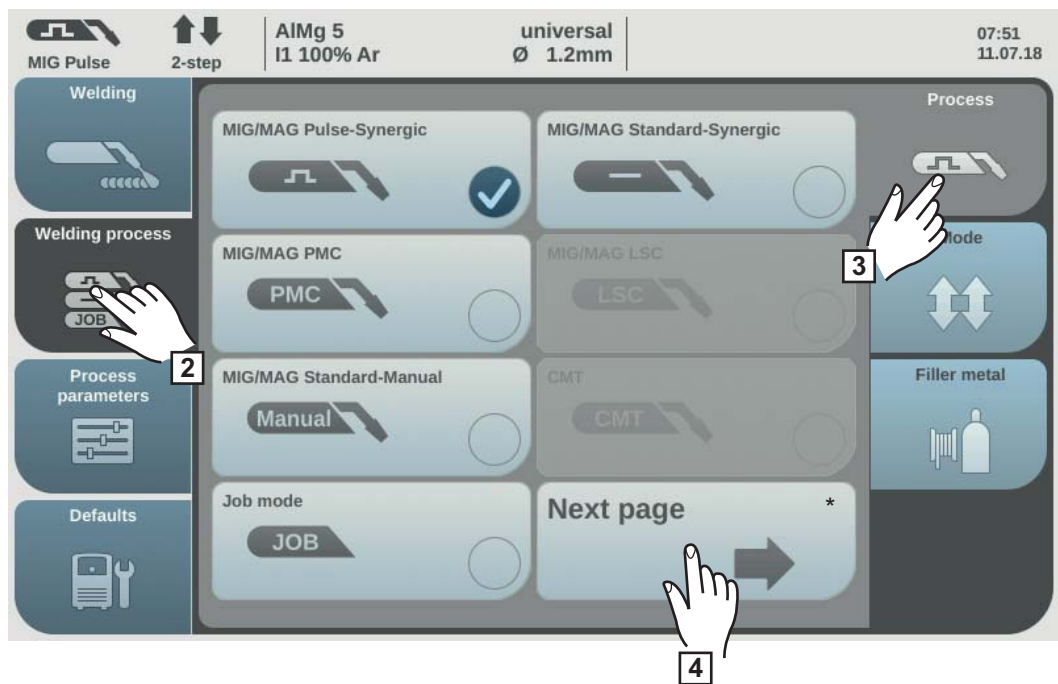

* next page: Electrode, TIG

- 2 Select "Welding process"
- 3 Select "Process"

An overview of the welding process is displayed. Various welding processes are available depending on the power source type or function package installed.

- 4 Select "Next page"

The 2nd page of the welding process overview is displayed.

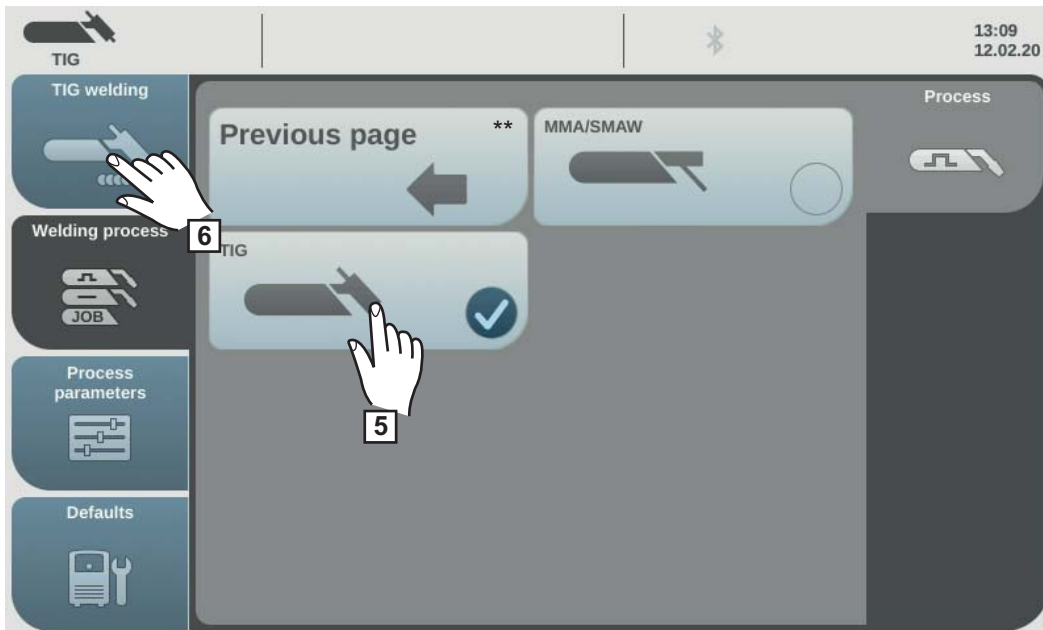

** previous page: MIG/MAG pulse synergic, MIG/MAG standard synergic, MIG/MAG PMC, MIG/MAG LSC, MIG/MAG standard manual, CMT and Job mode

5 Select TIG

The welding voltage is connected to the welding socket with a 3-second time lag.

NOTE!

Parameters that have been set on a system component control panel (e.g. wire feed unit or remote control) might not be able to be changed on the power source control panel.

6 Select "TIG welding"

The TIG welding parameters are shown.

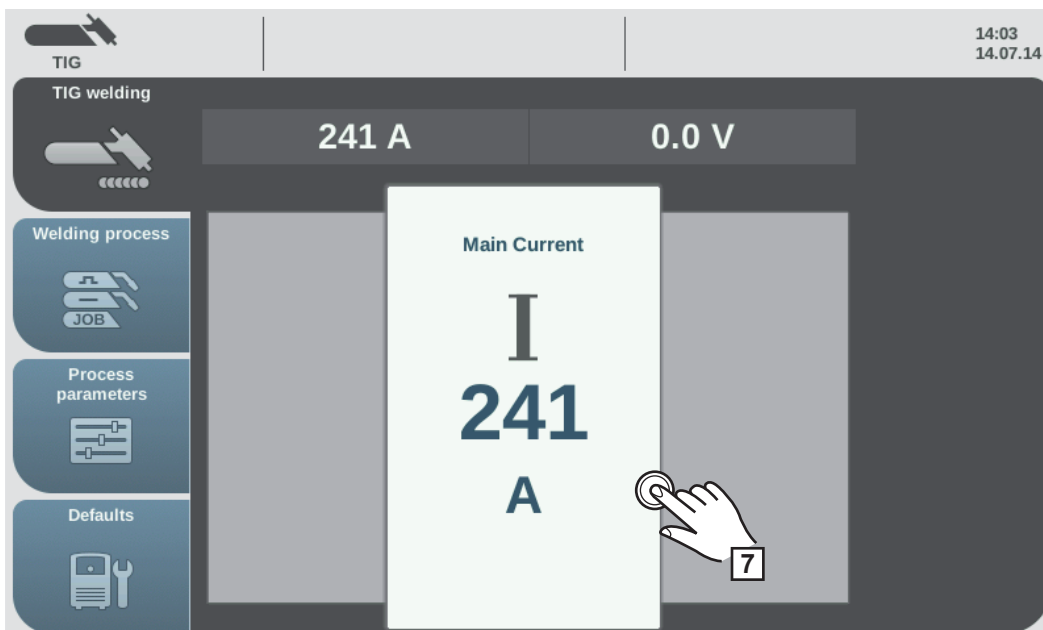

- 7 Press the adjusting dial to change the welding parameter

The value of the welding parameter is displayed as a horizontal scale:

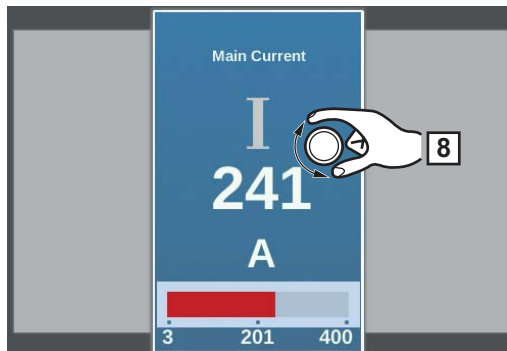

The value of the selected parameter can now be changed.

- 8 Turn the adjusting dial and change the parameter
- 9 Adjust the process parameters accordingly to make user or application-specific settings on the welding system
- 10 Open the gas stop valve on the TIG gas-valve torch
- 11 Set the desired shielding gas flow rate on the pressure regulator
- 12 Start welding (igniting the arc)

Igniting the arc

The welding arc is ignited by touching the workpiece with the tungsten electrode.

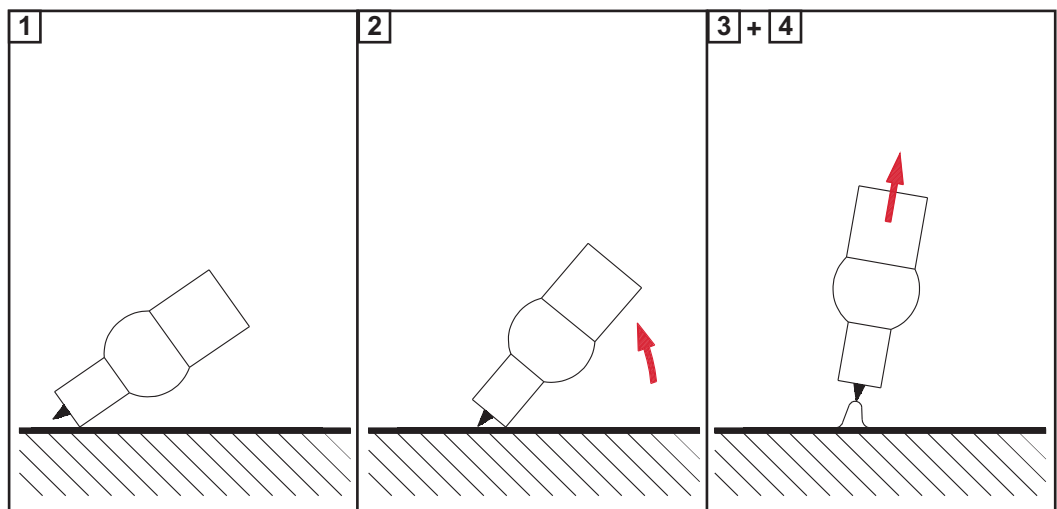

- 1 Place the gas nozzle on the ignition location so that there is 2-3 mm (0.08 - 0.12 in.) between the tip of the tungsten electrode and the workpiece. Keep a distance
- 2 Gradually tilt the welding torch up until the tungsten electrode touches the workpiece
- 3 Raise the welding torch and tilt it into the normal position - the arc now ignites
- 4 Carry out welding

Finishing welding 1 Lift the TIG gas-valve torch away from the workpiece until the arc goes out.

IMPORTANT! To protect the tungsten electrode, ensure that the shielding gas at the end of welding flows for long enough to allow the tungsten electrode to cool sufficiently.

2 Close the gas stop valve on the TIG gas-valve torch

MMA welding

Safety



WARNING!

Danger from incorrect operation.

Possible serious injury and damage to property.

- ▶ Do not use the functions described here until you have read and completely understood these Operating Instructions.
 - ▶ Do not use the functions described here until you have fully read and understood all of the Operating Instructions for the system components, in particular the safety rules!
-



WARNING!

An electric shock can be fatal.

If the power source is connected to the mains electricity supply during installation, there is a high risk of very serious injury and damage.

- ▶ Before carrying out any work on the device make sure that the power source mains switch is in the "O" position
 - ▶ Before carrying out any work on the device make sure that the power source is unplugged from the mains
-

Preparations

- 1 Move the mains switch to the "O" position
- 2 Disconnect the mains plug
- 3 Remove the MIG/MAG welding torch

NOTE!

Check the rod electrode packaging or labelling to determine whether the rod electrodes are for positive pole or negative pole welding.

- 4 Plug the grounding (earthing) cable into either the (-) or the (+) current socket depending on the type of electrode, and twist to fasten it
- 5 Use the other end of the grounding (earthing) cable to establish a connection to the workpiece
- 6 Plug the bayonet current plug of the electrode holder cable into the free current socket with the opposite polarity, according to the type of electrode, and twist it clockwise to latch it in place
- 7 Plug in the mains plug

⚠ CAUTION!

Risk of injury and damage from electric shock.

As soon as the mains switch is in the "I" position, the rod electrode in the electrode holder is live.

- ▶ Make sure that the rod electrode does not touch any persons or electrically conductive or earthed parts (e.g. the housing, etc.)

- 1 Move the mains switch to the "I" position

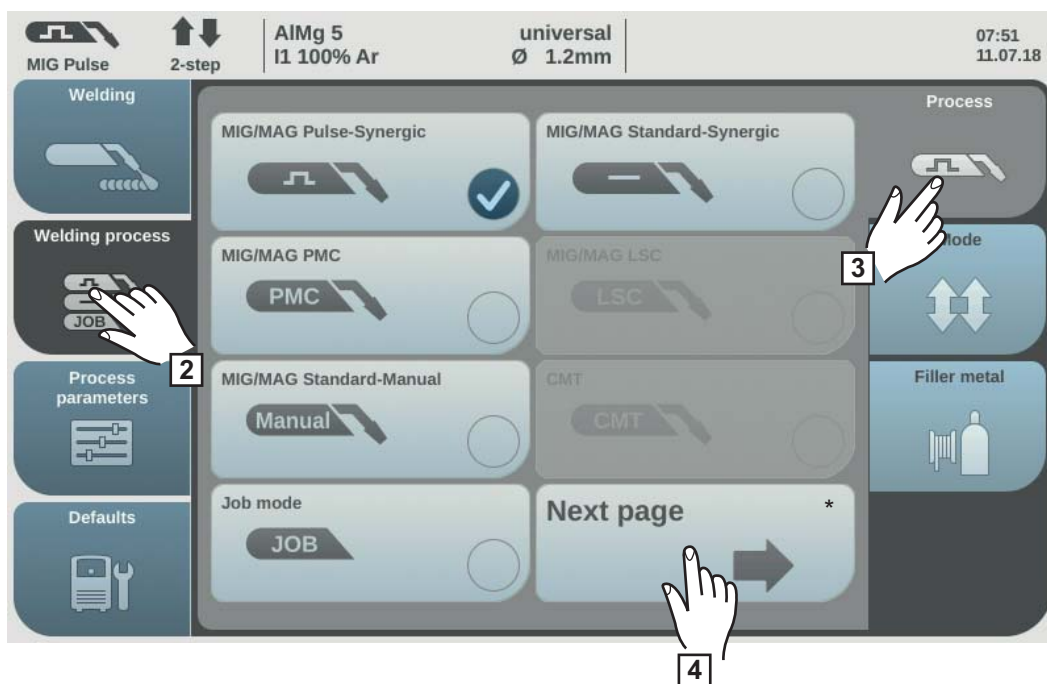

* next page: Electrode, TIG

- 2 Select "Welding process"
- 3 Select "Process"

An overview of the welding process is displayed. Various welding processes are available depending on the power source type or function package installed.

- 4 Select "Next page"

The 2nd page of the welding process overview is displayed.



** previous page: MIG/MAG pulse synergic, MIG/MAG standard synergic, MIG/MAG PMC, MIG/MAG LSC, MIG/MAG standard manual, CMT and Job mode

5 Select the MMA/SMAW welding process

The welding voltage is connected to the welding socket with a 3-second time lag.

If the MMA/SMAW welding process is selected, any cooling unit present is automatically deactivated. It is not possible to switch it on.

NOTE!

Parameters that have been set on a system component control panel (e.g. wire feed unit or remote control) might not be able to be changed on the power source control panel.

6 Select "MMA/SMAW welding"

The MMA welding parameters are shown.

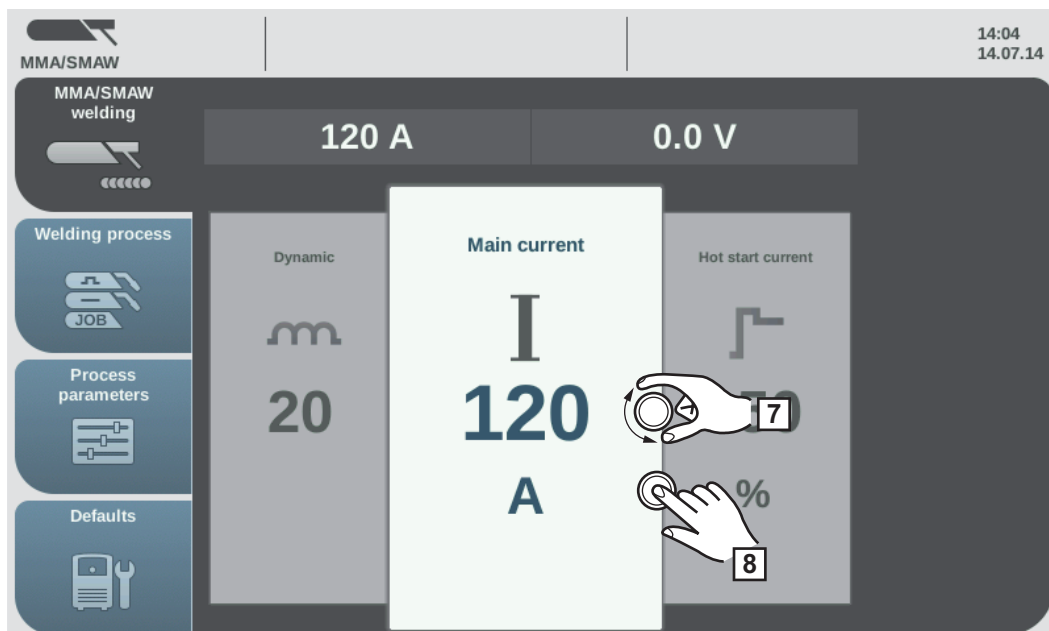

- 7** Turn the adjusting dial and select the desired welding parameter
- 8** Press the adjusting dial to change the welding parameter

The value of the welding parameter is displayed as a horizontal scale:

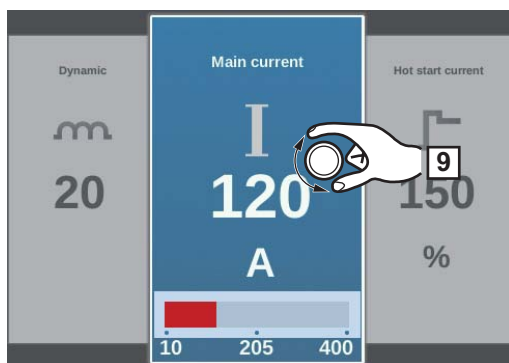

The value of the selected parameter can now be changed.

- 9** Turn the adjusting dial and change the parameter
- 10** Adjust the process parameters accordingly to make user or application-specific settings on the welding system
- 11** Start welding

Welding parameters for manual metal arc welding

The following welding parameters for MMA welding can be set and displayed by pressing the "Welding" button:

Main current [A]

Setting range: depends on the power source available

Before the start of welding, the machine automatically displays a standard value based on the programmed parameters. The actual value is displayed during welding.

Starting current

for setting a starting current value in the range 0 - 200% of the set welding current in order to avoid slag inclusions or incomplete fusion.

The starting current depends on the electrode type.

0 - 200%

Factory setting: 150%

The starting current is active for the starting current time set under the process parameters.

Arc-force dynamic

to influence the short-circuiting dynamic at the instant of droplet transfer

0 - 100

Factory setting: 20

0 ... soft and low-spatter arc

100 ... harder and more stable arc

Process parameters

Overview

Overview - Process parameters, Common

The "Process parameters" menu button has the following selection options under "Common":

Weld-Start / Weld-End	Gas-Setup
Process control	Synchropulse
Process mix	CMT Cycle Step *
Spot welding	Next page
Previous page	R/L-check / alignment
TIG/electrode setup	

* Only displayed if the OPT/i CMT Cycle Step option is present on the power source.

Overview – components and monitoring process parameters

The "Process parameters" menu item has the following selection options under "Components & monitoring":

Components	System adjust
Arc break watchdog settings	Wire stick contact tip
Wire stick workpiece	Wire end monitoring
Gas monitoring	

Overview – Job process parameters

The "Process parameters" menu button has the following selection options under "Job":

Optimize Job	Correction limits
Pre-settings for "Save as Job"	

Process parameters, General

Process parameters for start of welding/end of welding

The following process parameters can be set and displayed for the start and end of welding:

Starting current

for setting the starting current for MIG/MAG welding (e.g. aluminium welding start-up)

0 - 200% (of welding current)

Factory setting: 135%

Start arc length correction

for correcting the arc length at the start of welding

-10.0 - +10.0% (of welding voltage)

Factory setting: 0.0%

- shorter arc length

0 ... neutral arc length

+ ... longer arc length

Starting current time

for setting the length of time the starting current is to be active

off / 0.1 - 10.0 s

Factory setting: off

Slope 1

for setting the time during which the starting current is decreased or increased to the welding current

0.0 - 9.9 s

Factory setting: 1.0 s

Slope 2

for setting the time during which the welding current is decreased or increased to the final current.

0.0 - 9.9 s

Factory setting: 1.0 s

Final current

for setting the final current so that

- a) heat build-up towards the end of welding is prevented and
- b) the end-crater can be filled when welding aluminium

0 - 200% (of welding current)

Factory setting: 50%

End arc length correction

for correcting the arc length at the end of welding

-10.0 - +10.0% (of welding voltage)

Factory setting: 0.0%

- shorter arc length

0 ... neutral arc length

+ ... longer arc length

Final current time

for setting the length of time for which the final current is to be active

off / 0.1 - 10.0 s

Factory setting: off

SFI

to activate/deactivate the SFI function (Spatter Free Ignition)

off / on

Factory setting: off

SFI HotStart

for setting a HotStart time in conjunction with SFI ignition

During SFI ignition, a spray arc phase occurs within the set HotStart time. This increases the heat input irrespective of the mode, thus ensuring deeper penetration right from the very start of welding.

off / 0.01 - 2.00 s

Factory setting: off

Wire withdrawal

For setting the wire withdrawal value (= composite value based on backward movement of wire and a time).

The wire withdrawal depends on the features of the welding torch.

0.0 - 10.0

Factory setting: 0.0

Ignition current (manual)

for setting the ignition current for MIG/MAG standard manual welding

100 - 550 A (TPS 320i)

100 - 600 A (TPS 400i, TPS 400i LASC ADV)

100 - 650 A (TPS 500i, TPS 600i)

Factory setting: 500 A

Wire withdrawal (manual)

for setting the wire withdrawal value (= composite value based on backward movement of wire and a time) for MIG/MAG standard manual welding.

The wire withdrawal depends on the features of the welding torch.

0.0 - 10.0

Factory setting: 0.0

Process parameters for Gas-Setup

The following process parameters can be set and displayed for Gas-Setup:

Gas pre flow

for setting the gas flow time before the arc is ignited

0 - 9.9 s

Factory setting: 0.1 s

Gas postflow

for setting the gas flow time after the arc has gone out

0 - 9.9 s

Factory setting: 0.5 s

Command value gas

Shielding gas flow rate

(only in conjunction with the OPT/i gas flow rate sensor option)

off / 0.5 - 30.0 l/min

Factory setting: 15.0 l/min

IMPORTANT! If a high shielding gas flow rate is set (e.g. 30 l/min), ensure that the gas supply line is adequately dimensioned.

Gas factor

dependent on the shielding gas used

(only in conjunction with the OPT/i gas flow rate sensor option)

auto / 0.90 - 20.00

Factory setting: auto

(the correction factor is automatically set for standard gases from the Fronius welding database)

In Job Mode, the set values of the parameters listed above can be stored individually for each job.

Process parameters for process control

The following process parameters can be set and displayed for the process control:

- Penetration stabiliser
 - Arc length stabiliser
 - Combination of penetration stabiliser and arc length stabiliser
-

Penetration stabilizer

The penetration stabilizer is used to set the max. permitted change in the wire speed to ensure that the welding current and hence the penetration is kept stable or constant with variable stick out.

The penetration stabilizer parameter is only available when the WP PMC (Welding Process Pulse Multi Control) or WP LSC (Welding Process Low Spatter Control) option has been enabled on the power source.

0 - 10.0 m/min (ipm)

Factory setting: 0 m/min

0

The penetration stabilizer is not activated.

The wire speed remains constant.

0.1 - 10.0

The penetration stabilizer is activated.

The welding current remains constant.

Application examples

Penetration stabilizer = 0 m/min (not activated)

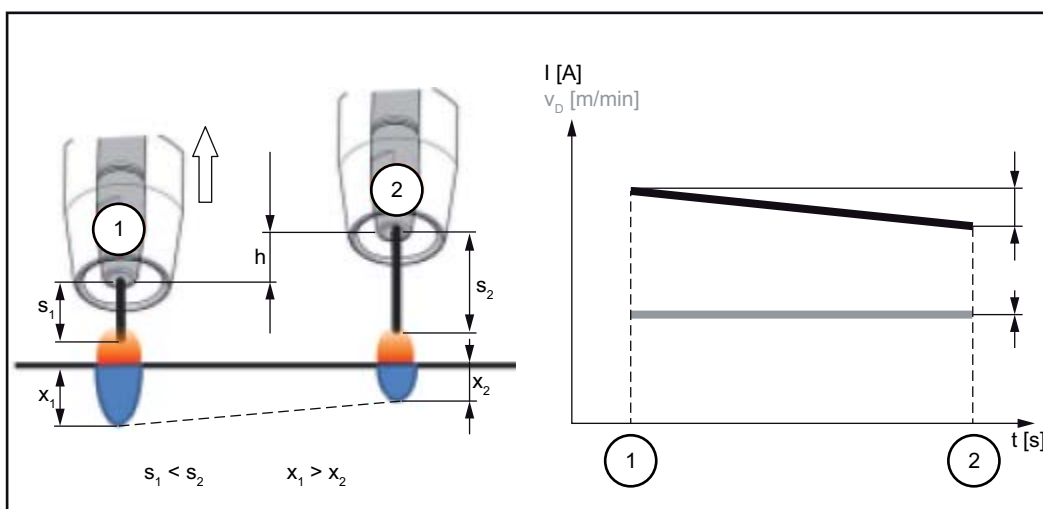

Penetration stabilizer = 0 m/min (not activated)

Changing the contact tube distance (h) alters the resistance in the welding circuit due to the longer stick out (s_2).

The constant voltage control for constant arc length causes a reduction in the mean current value and hence a smaller penetration (x_2).

Penetration stabilizer = n m/min (activated)

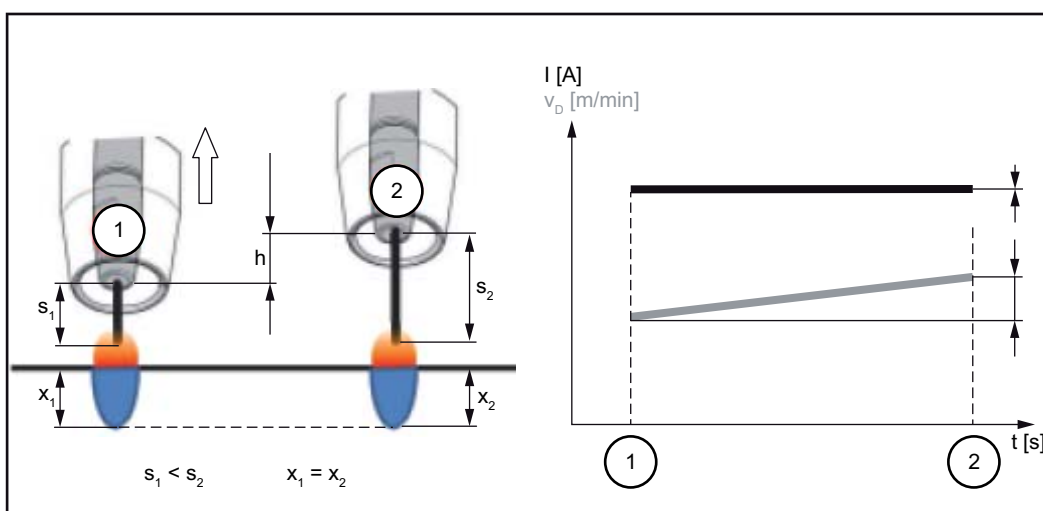

Penetration stabilizer = n m/min (activated)

Specifying a value for the penetration stabilizer ensures a constant arc length without large current variations if the stick out is changed ($s_1 \Rightarrow s_2$).

The penetration (x_1, x_2) remains virtually unchanged and stable.

Penetration stabilizer = 0.5 m/min (activated)

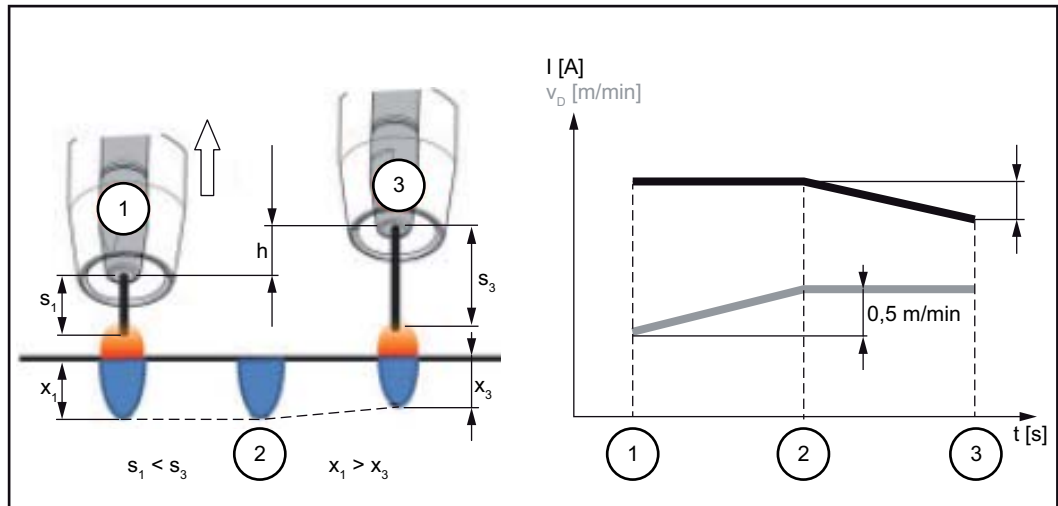

Penetration stabilizer = 0.5 m/min (activated)

To minimise the change in welding current if the stick out is changed ($s_1 \implies s_3$), the wire speed is increased or reduced by 0.5 m/min.

In the example shown, the stabilising effect is obtained without a change in current up to the set value of 0.5 m/min (Position 2).

I ... Welding current v_D ... Wire speed

Arc length stabilizer

Arc length stabilizer

The arc length stabilizer forces short arcs, advantageous for welding, via a short-circuit current control and keeps them stable even with a variable stick out or external interference.

The arc length stabilizer welding parameter is only available if the WP PMC (Welding Process Pulse Multi Control) option has been enabled on the power source.

0.0 - 5.0 (effect of stabilizer)

Factory setting: 0.0

0.0

The arc length stabilizer is deactivated.

0.1 - 5.0

The arc length stabilizer is activated.

The arc length is decreased until short circuits start to occur.

Application examples

Arc length stabilizer = 0 / 0.5 / 2.0

① Arc length stabilizer = 0

② Arc length stabilizer = 0.5

③ Arc length stabilizer = 2

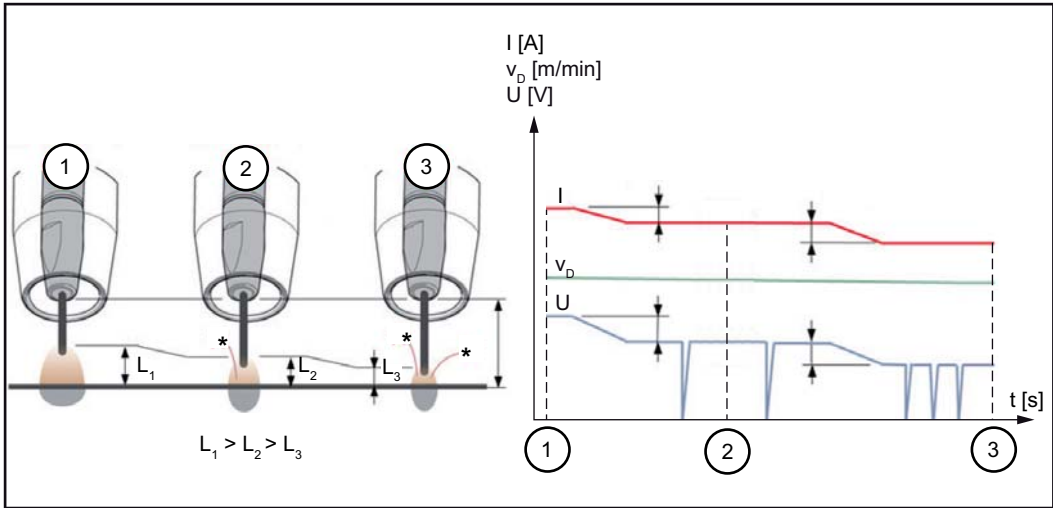

Arc length stabilizer = 0 / 0.5 / 2.0

Activating the arc length stabilizer reduces the arc length until short circuits start to occur. The frequency of the short circuits is controlled and kept stable.

Increasing the arc length stabilizer causes a further shortening of the arc length ($L_1 \implies L_2 \implies L_3$). The advantages of a short, stable and controlled arc can be used more effectively.

Arc length stabilizer with change of weld seam profile and position

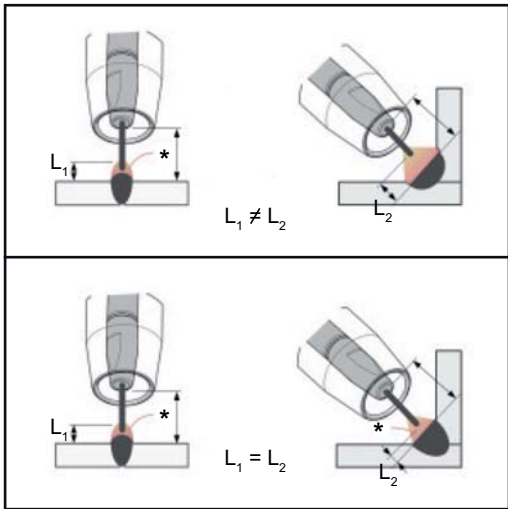

Arc length stabilizer not activated

A change of weld seam profile or welding position can negatively affect the welding result

Arc length stabilizer activated

Since the number and duration of the short circuits is controlled, the properties of the arc stay the same if the weld seam profile or welding position is changed.

I ... Welding current v_D ... Wire speed U ... Welding voltage
 * ... Number of short circuits

Combination of penetration stabilizer and arc length stabilizer

Example: Stick out change

Arc length stabilizer without penetration stabilizer

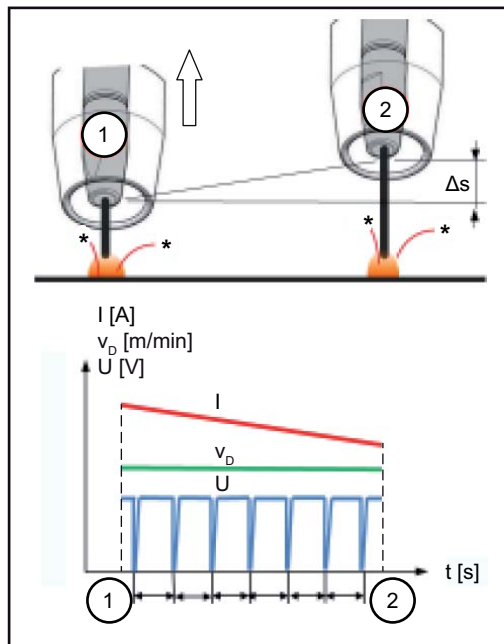

The advantages of a short arc are maintained even if the stick out is changed, since the short-circuit properties stay the same.

Arc length stabiliser with penetration stabilizer

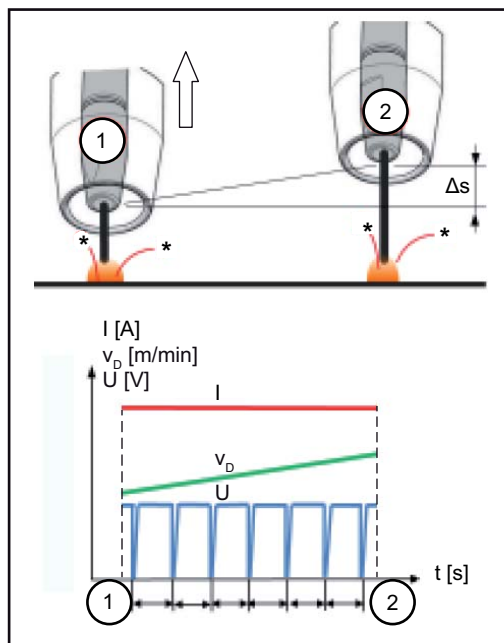

If the stick out is changed with the penetration stabilizer activated, the penetration also stays the same. The short circuit behaviour is controlled by the arc length stabilizer.

I ... Welding current v_D ... Wire speed U ... Welding voltage
 * ... Number of short circuits Δs ... Stick out change

Process parameters for SynchroPulse

The following process parameters can be set for SynchroPulse welding:

(1) SynchroPulse

to activate/deactivate SynchroPulse

off / on

Factory setting: on

(2) Wire speed

for setting the average wire speed and therefore the welding power for SynchroPulse

e.g.: 2 - 25 m/min (ipm)

(depending on wire speed and welding characteristic)

Factory setting: 5.0 m/min

(3) Delta wire feed

for setting the Delta wire feed:

with SynchroPulse, the set wire speed is alternately increased/decreased by the Delta wire feed. The parameters concerned adapt themselves to this wire speed acceleration/delay accordingly.

0.1 - 6.0 m/min / 5 - 235 ipm

Factory setting: 2.0 m/min

(4) Frequency F

for setting the frequency for SynchroPulse

0.5 - 3.0 Hz

Factory setting: 3.0 Hz

(5) Duty Cycle (high)

for weighting the duration of the higher operating point in a SynchroPulse period

10 - 90%

Factory setting: 50 Hz

(6) Arc correction high

for correcting the arc length for SynchroPulse in the upper operating point (= average wire speed plus Delta wire speed)

-10.0 - +10.0

Factory setting: 0.0

- short arc

0 ... uncorrected arc length

+ ... longer arc

(7) Arc correction low

for correcting the arc length for SynchroPulse in the lower operating point (= average wire speed less Delta wire speed)

-10.0 - +10.0

Factory setting: 0.0

- short arc

0 ... uncorrected arc length

+ ... longer arc

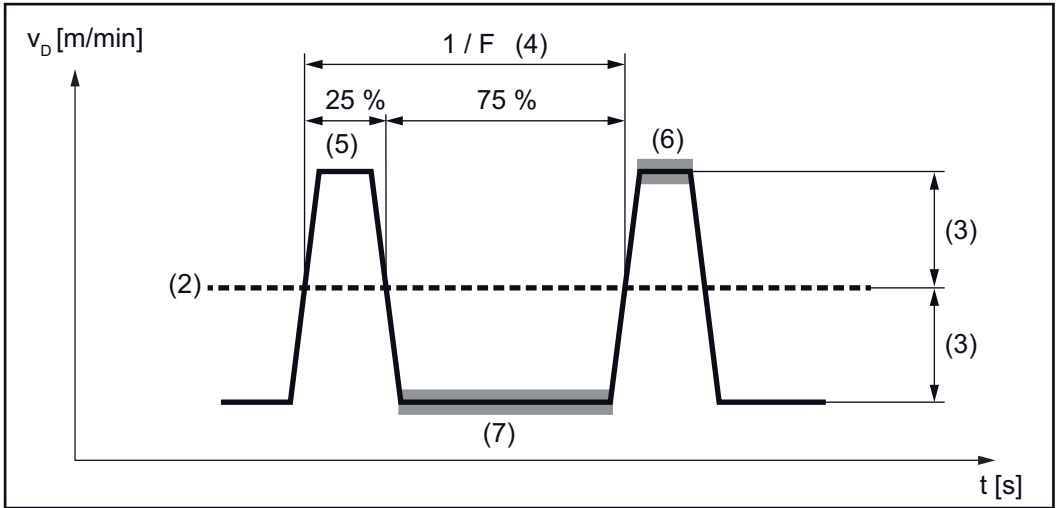

SynchroPulse example, duty cycle (high) = 25%

Process parameters for Process mix

The following process parameters for mixed processes can be set under "Process mix":

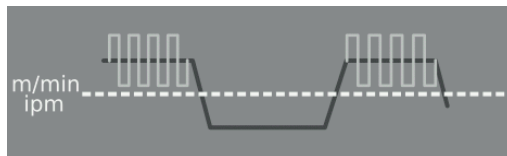

Wire speed v_D *

Wire speed

1.0 - 25.0 m/min / 40 - 985 ipm

The wire speed value is applied or can be specified and changed in the Process mix parameters.



Arc length correction

-10.0 - +10.0

The arc length correction value is applied or can be specified and changed in the Process mix parameters.

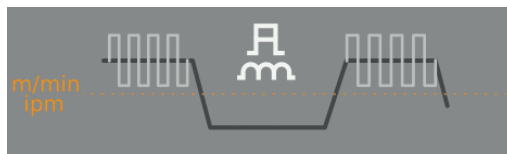

Pulse/dynamic correction

for changing the pulse energy in the pulsed arc process phase

-10.0 - +10.0

The pulse/dynamic correction value is applied or can be specified and changed in the process mix parameters.

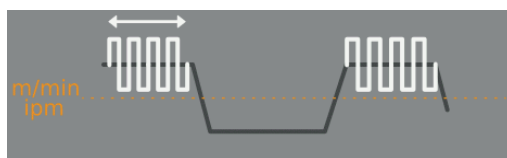

Upper power time correction (3) *

to set the duration of the hot process phase in a mixed process

-10.0 - +10.0

Factory setting: 0

Upper and lower power time correction is used to define the relationship between hot and cold process phases.

If the upper power time correction is increased, the process frequency reduces and the PMC process phase becomes longer.

If the upper power time correction is reduced, the process frequency increases and the PMC process phase becomes shorter.

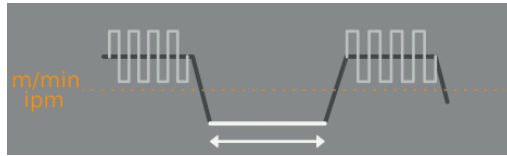

Lower power time correction (2) *

to set the duration of the cold process phase in a mixed process

-10.0 - +10.0

Factory setting: 0

Upper and lower power time correction is used to define the relationship between hot and cold process phases.

If the lower power time correction is increased, the process frequency reduces and there is a longer LSC process phase or a longer CMT process phase for CMT mix.

If the lower power time correction is reduced, the process frequency increases and there is a shorter LSC process phase or a shorter CMT process phase for CMT mix.

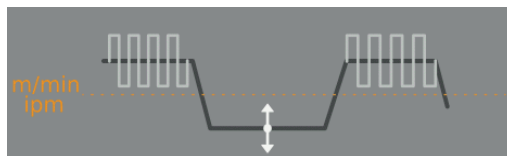

Lower power correction (1) *

to set the energy input in the cold process phase in a mixed process

-10.0 - +10.0

Factory setting: 0

If the lower power correction is increased, this results in a higher wire speed and therefore higher energy input in the cold LSC process phase or in the cold CMT process phase.

* Representation of the parameters in the following graphics

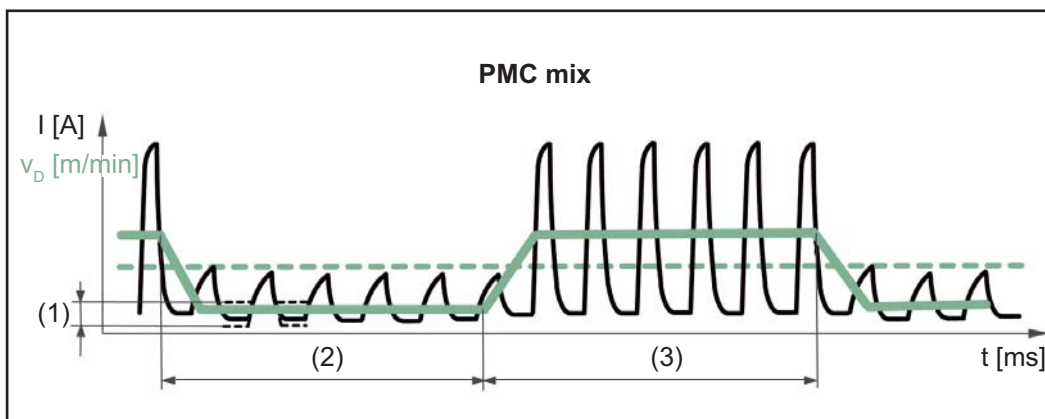

Mixed process between PMC and LSC welding process. A cold LSC process phase follows a hot PMC process phase as part of a cycle.

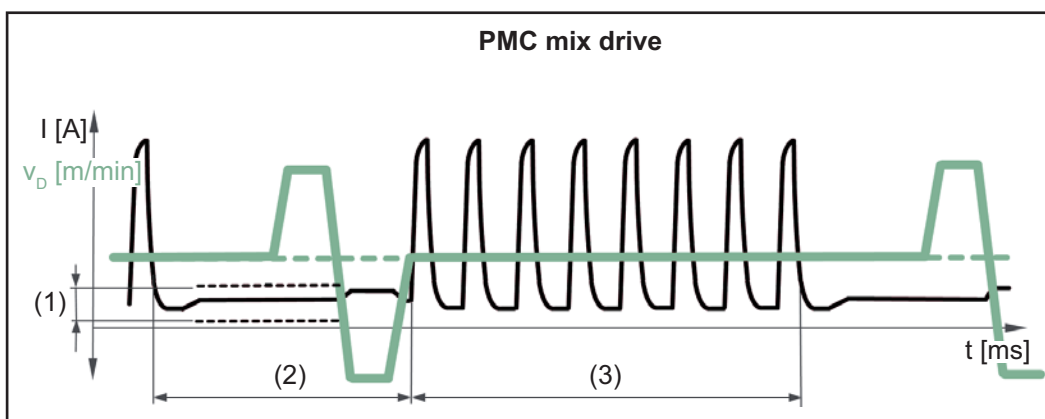

Mixed process between PMC and wire movement reversal using a PushPull drive unit. A cold low power phase with calibration movement follows a hot PMC process phase.

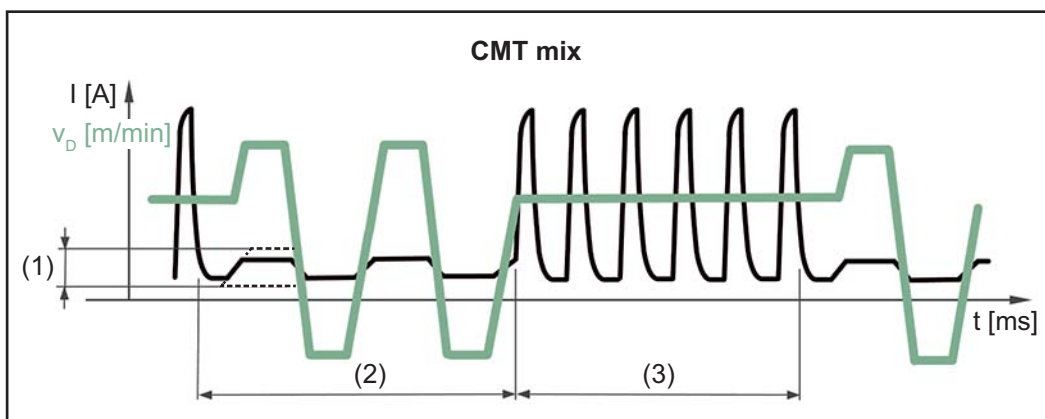

Mixed process between CMT and PMC welding process. Cold CMT process phases follow hot PMC process phases.

- (1) Lower power correction
- (2) Lower power time correction
- (3) Upper power time correction
- v_D Wire speed

Process parameters for CMT Cycle Step

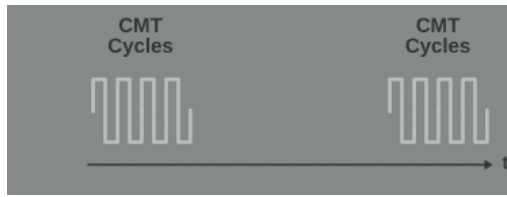

CMT Cycle Step

for activating/deactivating the CMT Cycle Step function

On / Off

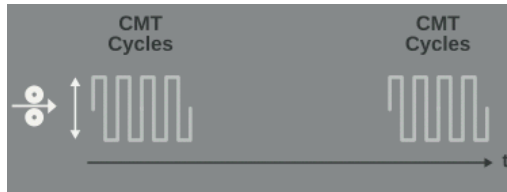

Wire speed

Wire speed, determines the deposition rate during the welding process phase and therefore the size of the welding spot;

Setting range: in m/min (ipm), dependent on the welding characteristic

The wire speed value is applied or can also be specified or changed in the CMT Cycle Step parameters.



Cycles (welding spot size)

for setting the number of CMT cycles (weld droplets) for a welding spot; the number of CMT cycles and the set wire speed determine the size of the welding spot.

1 - 2000

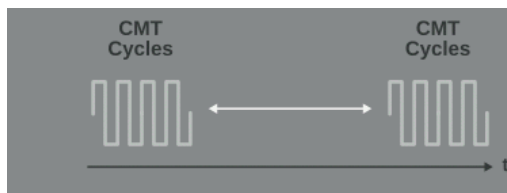

Pause time interval

for setting the time between each welding spot

0.01 - 2.00 s

The higher the value for the pause time interval, the cooler the welding process is (heavier flaking).

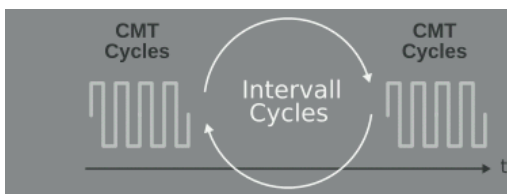

Cycles interval

for setting the number of repeated CMT cycles including pauses until the end of welding

constant / 1 - 2000

constant

The repetitions are carried out continuously;
end of welding, for example using "Arc Off"

Process parameters for spot welding

Spot welding time

0.1 - 10.0 s

Factory setting: 1.0 s

R/L-check / alignment

Align the welding circuit resistance (R) and welding circuit inductivity (L) if one of the following components of the welding system is changed:

- Torch hosepacks
- Interconnecting hosepacks
- Grounding cables, welding power-leads
- Wirefeeders
- Welding torches, electrode holders
- PushPull units

Prerequisites for R/L alignment:

The welding system must be complete: closed welding circuit with welding torch and torch hosepack, wirefeeders, grounding cable, interconnecting hosepacks.

Performing R/L alignment:

1 Select Process parameters / General / Next page

2 Select "Next page"

3 Select "R/L-check / alignment"

The current welding circuit inductivity and welding circuit resistance values are displayed.

4 Select "Next" / press the adjusting dial / press the torch trigger

The second step of the R/L alignment wizard appears.

5 Follow the displayed instructions

IMPORTANT! Contact between the earthing clamp and workpiece must be established on a cleaned area of the workpiece.

6 Select "Next" / press the adjusting dial / press the torch trigger

The third step of the R/L alignment wizard appears.

- 7 Follow the displayed instructions
- 8 Select "Next" / press the adjusting dial / press the torch trigger

The fourth step of the R/L alignment wizard appears.

- 9 Follow the displayed instructions
- 10 Press the torch trigger / select "Next" / press the adjusting dial

After a successful measurement, the current values are displayed.

- 11 Select "Finish" / press the adjusting dial

Process parameters for TIG/MMA/SMAW setup

The following process parameters can be set and displayed for the TIG and rod electrode welding processes:



Process parameters for MMA welding:

Start current time

for setting the length of time the start current is to be active

0.0 - 2.0 s

Factory setting: 0.5 s

Characteristic

for selecting the electrode characteristic

I-constant / 0.1 - 20.0 A/V / P-constant / arc air gouging

Factory setting: I-constant

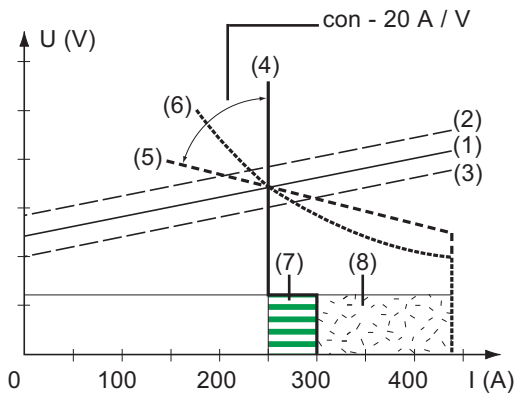

- (1) Load line for rod electrode
- (2) Load line for rod electrode where arc length is increased
- (3) Load line for rod electrode where arc length is reduced
- (4) Characteristic where "I-constant" parameter is selected (constant welding current)
- (5) Characteristic where "0.1 - 20" parameter is selected (drooping characteristic with adjustable slope)
- (6) Characteristic where "P-constant" parameter is selected (constant welding power)

(7) Example of pre-set arc-force dynamic where characteristic (4) is selected

(8) Example of pre-set arc-force dynamic where characteristic (5) or (6) is selected

I-constant (constant welding current)

- If the "I-constant" parameter is set, the welding current will be kept constant, irrespective of the welding voltage. This results in a vertical characteristic (4).
- The "I-constant" parameter is particularly suitable for rutile electrodes and basic electrodes.

0.1 - 20.0 A/V (drooping characteristic with adjustable slope)

- Parameter "0.1 - 20" is used to set a drooping characteristic (5). The setting range extends from 0.1 A / V (very steep) to 20 A / V (very flat).
- Setting a flat characteristic (5) is only advisable for cellulose electrodes.

P-constant (constant welding power)

- If the "P-constant" parameter is set, the welding power is kept constant, irrespective of the welding voltage and welding current. This results in a hyperbolic characteristic (6).
- The "P-constant" parameter is particularly suitable for cellulose electrodes.

Arc air gouging

- Special characteristic for arc air gouging with a carbon electrode

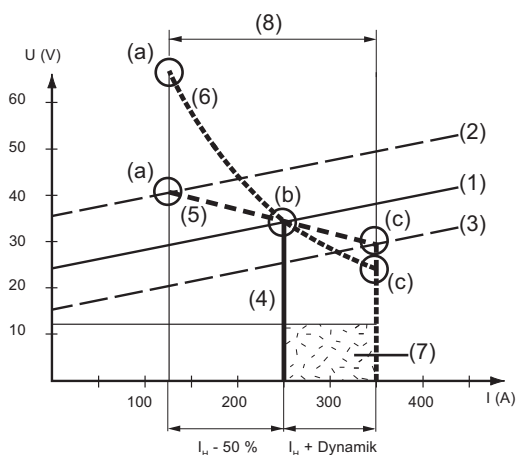

- (1) Load line for rod electrode
- (2) Load line for rod electrode where arc length is increased
- (3) Load line for rod electrode where arc length is reduced
- (4) Characteristic where "I-constant" parameter is selected (constant welding current)
- (5) Characteristic where "0.1 - 20" parameter is selected (drooping characteristic with adjustable slope)
- (6) Characteristic where "P-constant" parameter is selected (constant welding power)

- (7) Example of pre-set arc-force dynamic where characteristic (5) or (6) is selected
- (8) Possible change in the current where characteristic (5) or (6) is selected, as a function of the welding voltage (arc length)

- (a) Operating point where arc length is long
- (b) Operating point where welding current I_H is set
- (c) Operating point where arc length is short

The characteristics (4), (5) and (6) shown here apply when using a rod electrode whose characteristic corresponds - at a given arc length - to the load line (1).

Depending on what welding current (I) has been set, the point of intersection (operating point) of characteristics (4), (5) and (6) will be displaced along the load line (1). The operating point provides information on the actual welding voltage and the actual welding current.

Where the welding current (I_H) is permanently set, the operating point may migrate along the characteristics (4), (5) and (6) according to the welding voltage at a given moment. The welding voltage U is dependent upon the arc length.

If the arc length changes (e.g. in accordance with the load line (2)) the resulting operating point will be the point where the corresponding characteristic (4), (5) or (6) intersects with the load line (2).

Applies to characteristics (5) and (6): Depending upon the welding voltage (arc length), the welding current (I) will also become either smaller or larger, even though the value set for I_H remains the same.

Antistick

to activate/deactivate the anti-stick function

off / on

Factory setting: on

As the arc becomes shorter, the welding voltage may drop so far that the rod electrode will tend to stick. This may also cause the rod electrode to burn out.

The anti-stick function prevents the electrode from burning out. If the rod electrode begins to stick, the power source switches the welding current off after 1.5 seconds. After the rod electrode has been lifted off the workpiece, the welding process can be continued without any problems.

V cut off

for setting a voltage, at which the welding process can be ended by slightly lifting the rod electrode.

20 - 90 V

Factory setting: 90 V

The arc length depends on the welding voltage. To end the welding process, it is usually necessary to significantly lift the rod electrode away from the workpiece. With the break-voltage parameter, the welding voltage can be limited to a value that makes it possible to end the welding operation simply by lifting the rod electrode slightly.

IMPORTANT! If, during welding, you often find that the welding operation is ended unintentionally, increase the value of the break voltage.



Process parameters for TIG welding:

V cut off

for setting a voltage, at which the welding process can be ended by slightly lifting the TIG welding torch.

10.0 - 30.0 V

Factory setting: 14

Comfort Stop Sensitivity

to activate/deactivate the TIG Comfort Stop function

off / 0.1 - 1.0 V

Factory setting: 0.8 V

At the end of the welding operation, the welding current is switched off automatically if the arc length increases by more than a defined amount. This prevents the arc being unnecessarily elongated when the TIG gas-valve torch is lifted off the workpiece.

Sequence:

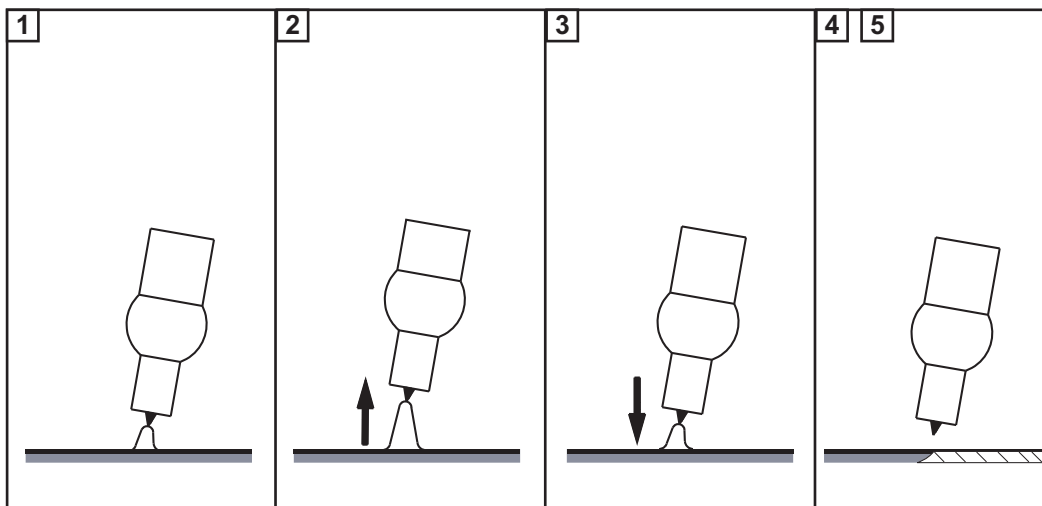

- 1 Welding
- 2 At the end of the welding action, briefly raise the welding torch
The arc length is increased significantly.
- 3 Lower the welding torch
 - The arc length is reduced significantly
 - The TIG Comfort Stop function is triggered
- 4 Keep the welding torch at the same height
 - The welding current is continuously decreased (downslope).
 - The arc goes out.

IMPORTANT! The downslope is pre-set and cannot be adjusted.

- 5 Raise the welding torch from the workpiece

Components and monitoring process parameters

Process parameters for components

The following process parameters can be set and displayed for the system components of a welding system:

Cooling unit mode

to determine whether a cooling unit is to be switched on or off, or operated automatically

eco / auto / on / off (depending on the cooling unit)

Factory setting: auto

Delay time flow sensor

for setting the time from when the flow sensor responds until a warning message is output

5 - 25 s

Factory setting: 5 s

Coolant flow warning level

(only if the flow temperature sensor option is present on the cooling unit)

If the parameter is activated, a warning is generated if the value entered is not reached.

off / 0.75 - 0.95 l/min

Factory setting: off

Inching value

for setting the wire speed at which the wire electrode is threaded into the torch hosepack

e.g. 2 - 25 m/min / 20 - 3935 ipm

(depending on the wire speed)

Factory setting: 10 m/min

Touchsensing sensitivity

For setting the TouchSensing sensitivity for various component surfaces and external influences

(TouchSensing = detection of the weld seam position using sensor voltage applied during automated welding)

TouchSensing uses the gas nozzle or the wire electrode.

TouchSensing by means of the gas nozzle only works if the OPT/i WF gas nozzle touch sensing option is installed in the robot wirefeeder and a robot interface is present.

0 - 10

Factory setting: 1

0

for bare surfaces, long and bolted short circuit, robust and not susceptible to interference

10

for oxidised surfaces, high measurement-related susceptibility to interference

Not suitable for welding on a component with multiple power sources!

Insulated surfaces cannot be detected.

Procedure for determining TouchSensing sensitivity:

- Start with the factory setting value 1
- If no triggering signal is detected, increase TouchSensing sensitivity

Ignition timeout

Length of wire that is fed before the safety cut-out trips

off / 5 - 100 mm (0.2 - 3.94 in.)

Factory setting: off

NOTE!**The ignition time-out process parameter is a safety function.**

The length of wire that is fed before the safety cut-out trips may differ from the pre-set wire length, particularly when the wire is being fed at fast wire speeds.

How it works:

Once the torch trigger is pressed, gas pre-flow begins immediately. Wirefeeding then begins, followed by ignition. If no current starts flowing before the specified length of wire has been fed, the power source cuts out automatically.

To try again, press the torch trigger again.

System adjust

If two motors are used in a welding system, they need to be calibrated to maintain process stability.

System calibration must be carried out on welding systems with PushPull units or unreeling wirefeeders following successful installation or replacement of a wirefeeder.

A notification will be displayed.

1 Select "OK" and start system calibration

The system calibration wizard starts.

2 Follow the instructions shown

System calibration can also be started manually here.

Perform system calibration:

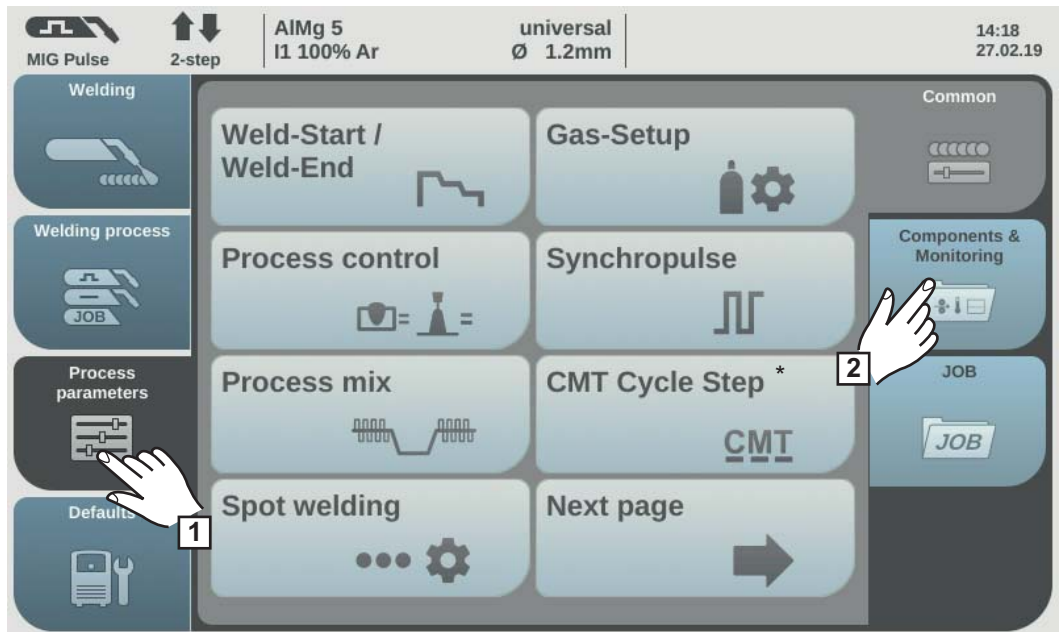

* Only displayed if the OPT/i CMT Cycle Step option is present on the power source. In TWIN mode, the TWIN process control button is displayed after the "Process mix" button.

- 1 Select "Process parameters"
- 2 Select "Components & Monitoring"

An overview of the process parameters for components and monitoring is displayed:

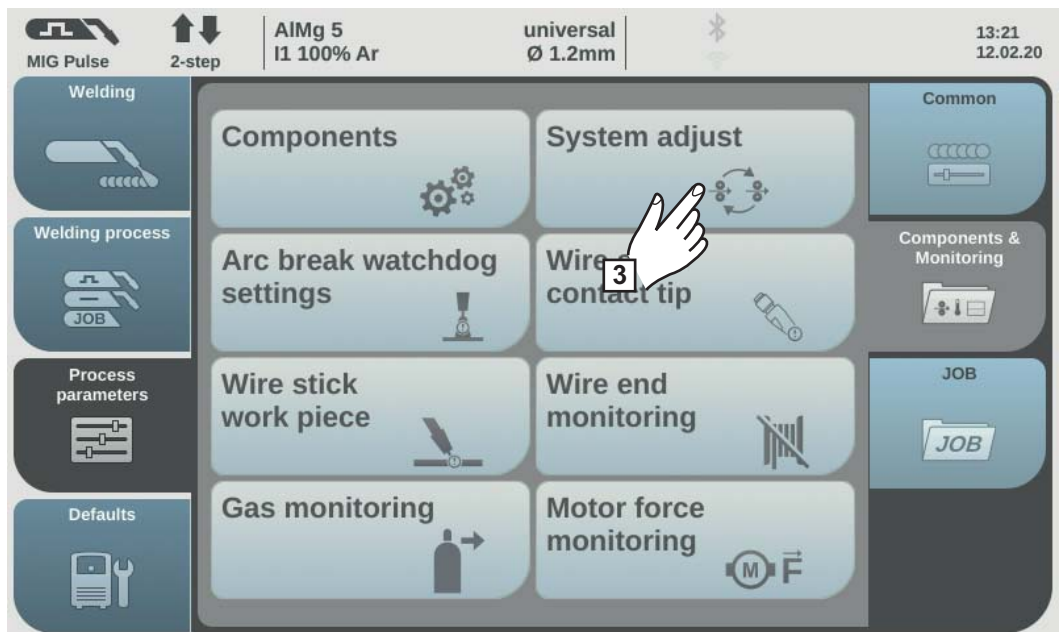

- 3 Select "System adjust"

If system calibration is required, the system calibration wizard starts. The first step in the system calibration wizard is displayed:

- 4 Follow the displayed instructions
- 5 To move to the next step in the wizard, select "Next" / press the adjusting dial

When system calibration has been completed successfully, a confirmation to this effect is displayed.

6 To close the system calibration wizard, select "Finish" / press the adjusting dial

Setting process parameters for arc break monitoring

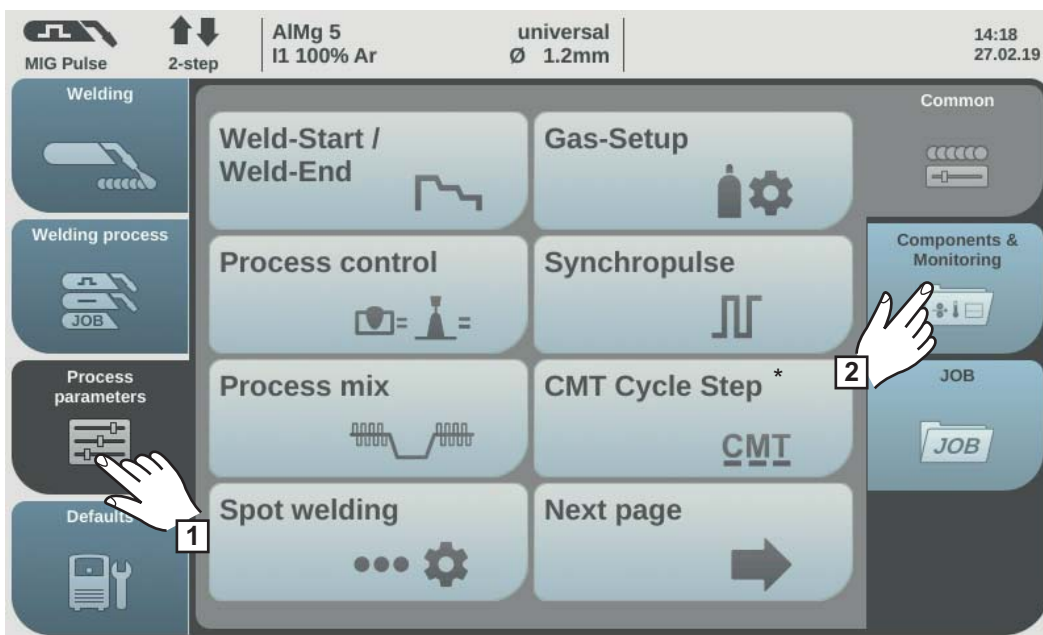

* Only displayed if the OPT/i CMT Cycle Step option is present on the power source. In TWIN mode, the TWIN process control button is displayed after the "Process mix" button.

- 1 Select "Process parameters"
- 2 Select "Components & Monitoring"

An overview of the process parameters for components and monitoring is displayed:

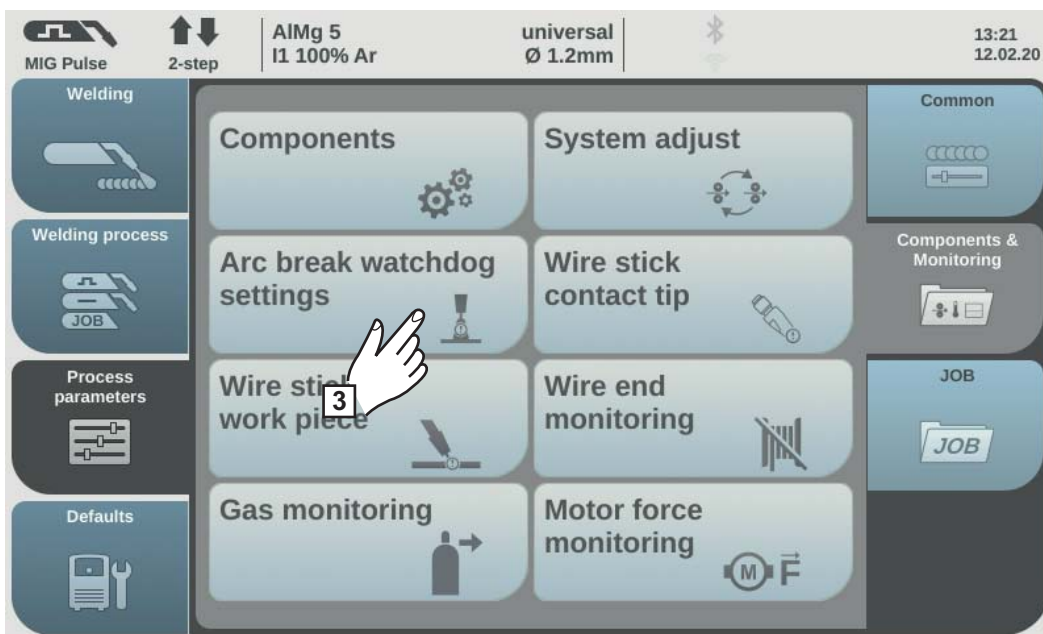

- 3 Select "Arc break watchdog settings"

The "Arc break watchdog settings" overview is displayed.

- 4 Turn the adjusting dial and select the desired parameter
- 5 Press the adjusting dial (blue background)

- 6 Turn the adjusting dial and change the value of the parameter (blue background)

Arc break reaction = ignore (deactivated):

The power source remains active and no error message appears on the display.

Arc break reaction = error (activated):

If the arc break fractures off and no current flow is detected within a set arc break period, the system shuts down automatically and an error message appears on the display.

Factory setting = ignore

Arc break time = 0 - 2.00 s

An error is output if the set period is exceeded.

Factory setting = 0.2 s

- 7 Select "OK" to activate arc break monitoring (arc break watchdog)

Process parameters for wire stick contact tip

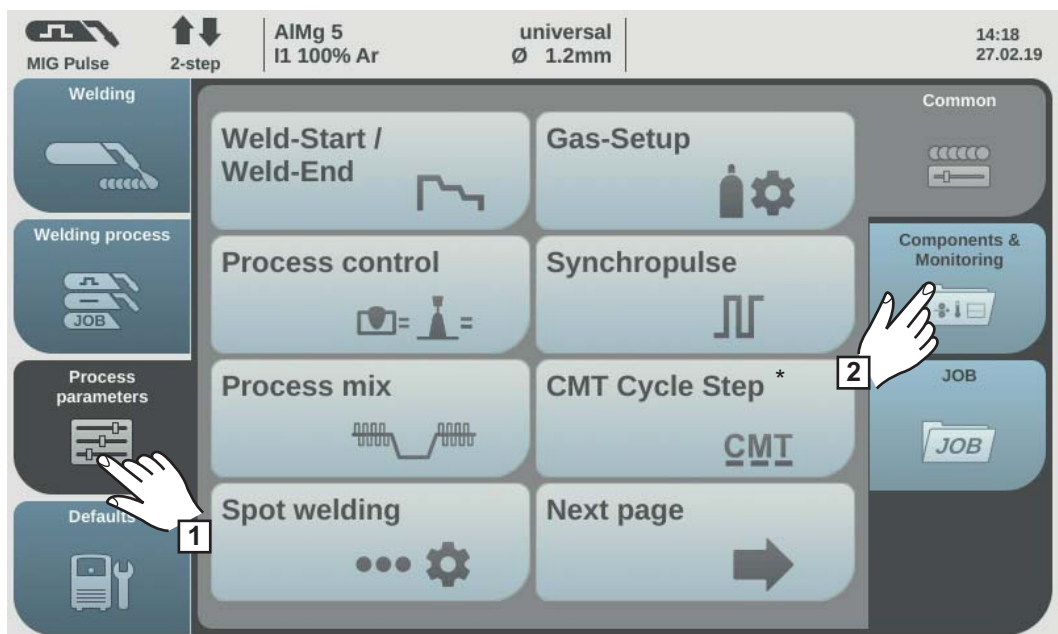

* Only displayed if the OPT/i CMT Cycle Step option is present on the power source. In TWIN mode, the TWIN process control button is displayed after the "Process mix" button.

- 1 Select "Process parameters"
2 Select "Components & Monitoring"

An overview of the process parameters for components and monitoring is displayed:

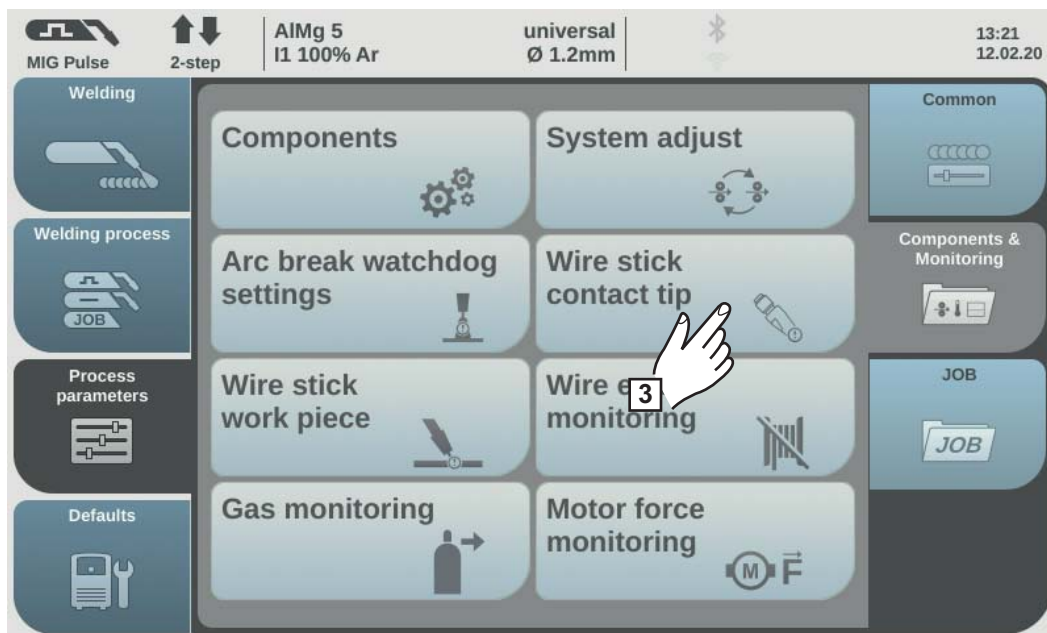

- 3 Select "Wire stick contact tip"

The overview "Wire stick contact tip - setup menu" is displayed.

- 4 Turn the adjusting dial and select the desired parameter
- 5 Press the adjusting dial (blue background)
- 6 Turn the adjusting dial and change the value of the parameter (blue background)

Wire stick on contact tip = ignore:

The wire stick check on the contact tip is deactivated.

Wire stick on contact tip = error (activated):

The welding process will be interrupted in the event of wire stick on the contact tip.

IMPORTANT! Monitoring is only possible during dip transfer arc processes.

Factory setting = ignore

Filter time = 0.5 - 5.0 s

Maximum duration without arc short circuit until welding is interrupted.

Factory setting = 0.5 s

- 7 Select "OK" to conclude the settings

Process parameters for wire stick workpiece

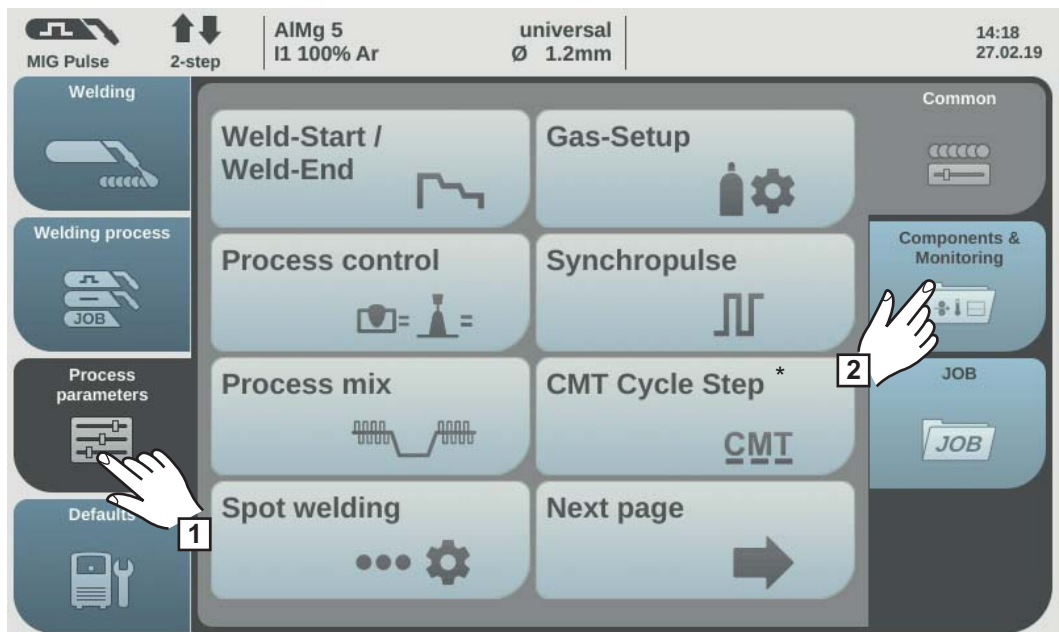

* Only displayed if the OPT/i CMT Cycle Step option is present on the power source. In TWIN mode, the TWIN process control button is displayed after the "Process mix" button.

- 1 Select "Process parameters"
- 2 Select "Components & Monitoring"

An overview of the process parameters for components and monitoring is displayed:

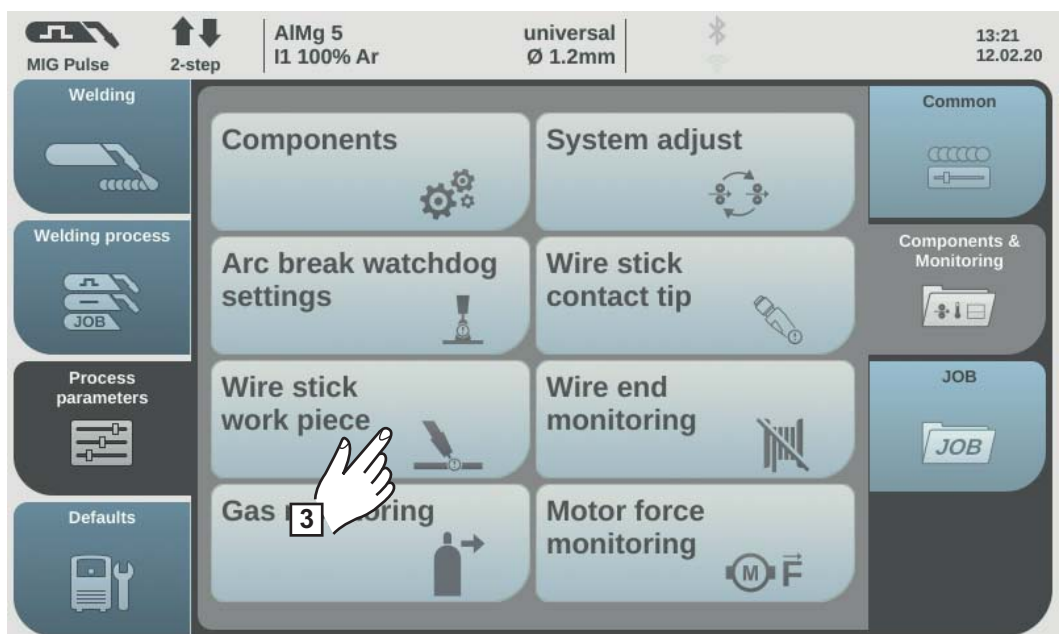

- 3 Select "Wire stick work piece"

The overview "Wire stick work piece - setup" is displayed.

- 4 Turn the adjusting dial and select the desired parameter
- 5 Press the adjusting dial (blue background)

- 6 Turn the adjusting dial and change the value of the parameter (blue background)

Wire stick on workpiece = ignore:
Wire stick monitoring on the workpiece is deactivated.

Wire stick on workpiece = error (activated):
The welding process will be interrupted if the wire sticks on the workpiece.

Factory setting = ignore

- 7 Select "OK" to conclude the settings

Process parameter for wire end monitoring

- 1 Select "Process parameters"
2 Select "Components & Monitoring"

An overview of the process parameters for components and monitoring is displayed:

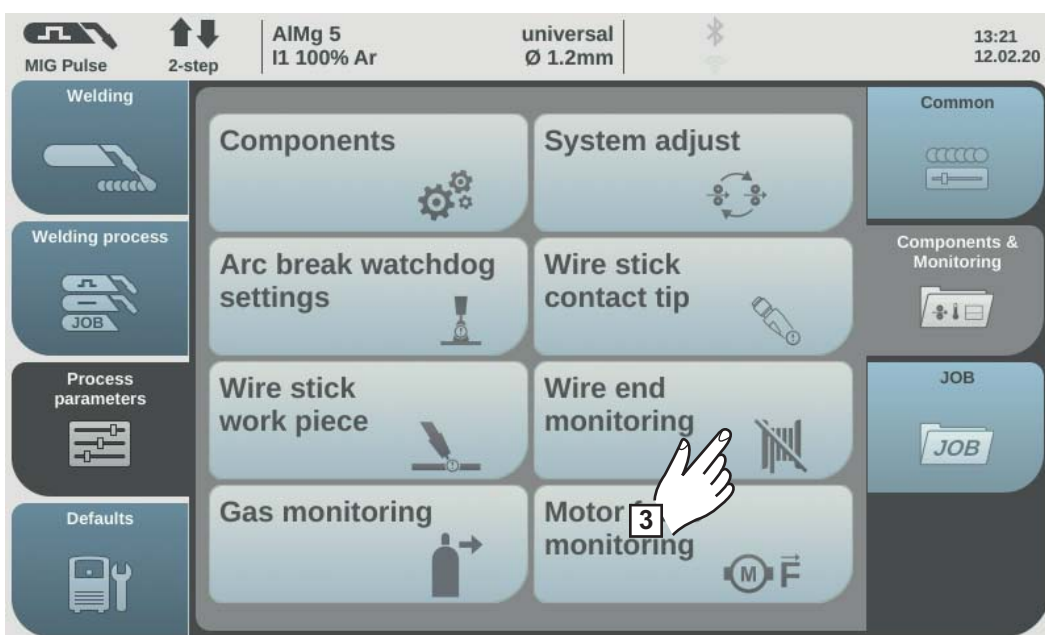

- 3 Select "Wire end monitoring"

The overview "Wire end monitoring - setup" is displayed.

- 4 Turn the adjusting dial and select the desired parameter, depending on the type of wire end monitoring:

Wire end ring sensor	(1) error
Wire end drum sensor	(2) error
Wire end wire spool	(3) error

- (1) Wire end reaction for OPT/i WF R WE ring sensor 4,100,878,CK
 (2) Wire end reaction for OPT/i WF R WE drum 4,100,879,CK
 (3) Wire end reaction for OPT/i WF R WE wire end 4,100,869,CK

- 5 Press the adjusting dial (blue background)

- 6 Turn the adjusting dial and change the value of the parameter (blue background)

Reaction = error:

Wire end fault, welding will be interrupted immediately. The fault will be shown on the display.

Reaction = after seam end:

The wire end fault will show on the display after the current welding process has ended.

Reaction= ignore (deactivated):

No reaction at the wire end

Factory setting = error

- 7 Select "OK" to conclude the settings

Process parameters for gas monitoring

The gas monitoring parameters are only available when the optional OPT/i gas flow rate sensor is present.

A lower limit for the gas flow rate can be set using gas monitoring. If the gas flow rate drops below this limit for a defined period of time, an error message is immediately issued and the welding operation is halted.

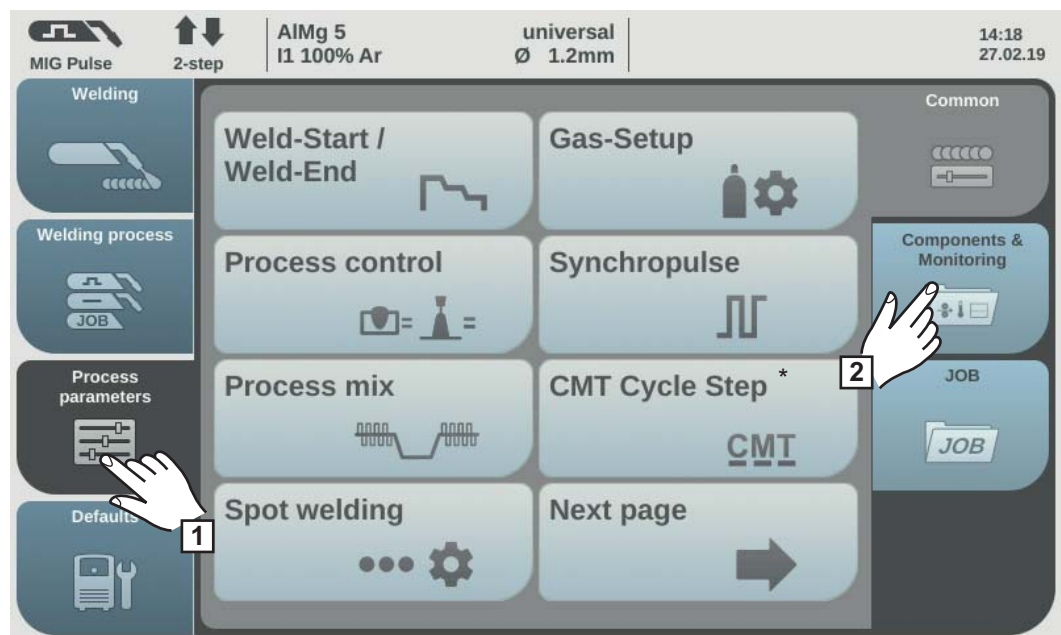

* Only displayed if the OPT/i CMT Cycle Step option is present on the power source. If the system has a Twin robot interface, the TWIN Process Control button is displayed after the Process Mix button.

- 1 Select "Process parameters"
2 Select "Components & Monitoring"

An overview of the process parameters for components and monitoring is displayed:

- 3 Select "Gas monitoring"

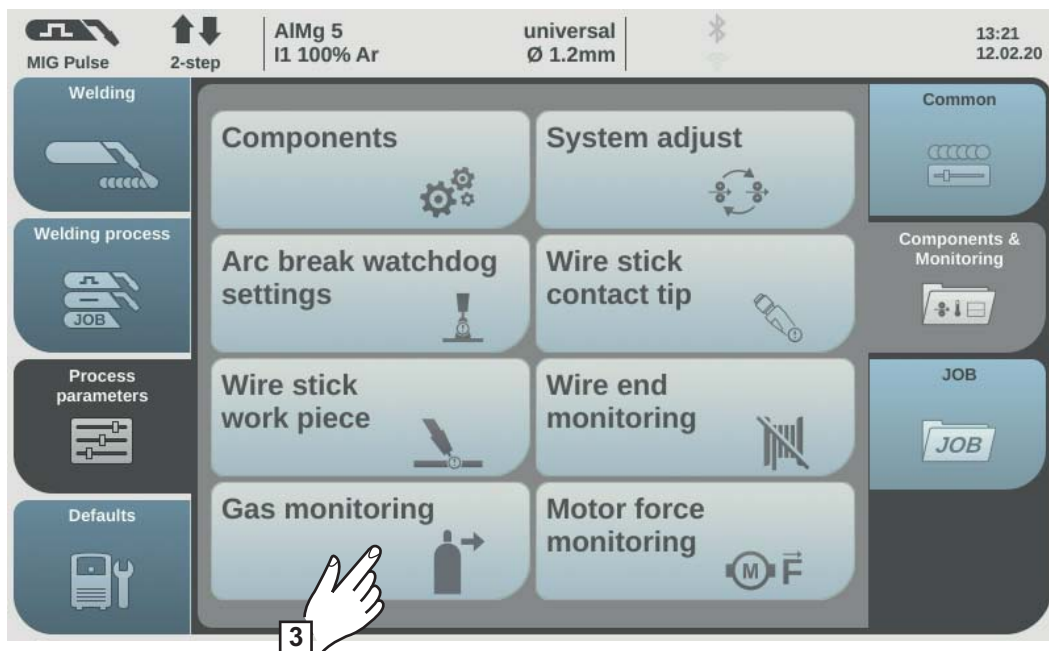

The "Gas monitoring" overview is displayed.

- 4 Turn the adjusting dial and select the desired parameter:

Lower gas flow limit
 Setting range: 0.5 - 30.0 l/min
 Factory setting: 7.0 l/min

Max. time of gas deviation
 Setting range: off / 0.1 - 10.0 s
 Factory setting: 2.0 s

Sensor gas factor
 Setting range: auto / 0.90 - 20.00
 Factory setting: auto

- 5 Press the adjusting dial (blue background)
- 6 Turn the adjusting dial to change the parameter value (blue background)
- 7 Select "OK" to conclude the settings

Motor force monitoring

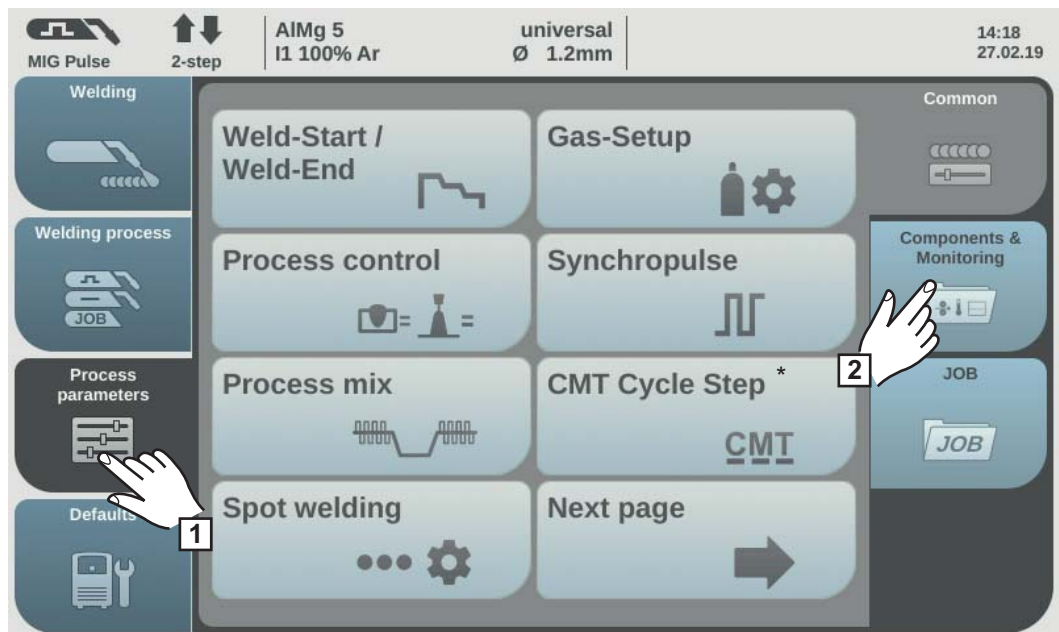

* Only displayed if the OPT/i CMT Cycle Step option is present on the power source. In TWIN mode, the TWIN process control button is displayed after the "Process mix" button.

- 1 Select "Process parameters"
- 2 Select "Components & Monitoring"

An overview of the process parameters for components and monitoring is displayed:

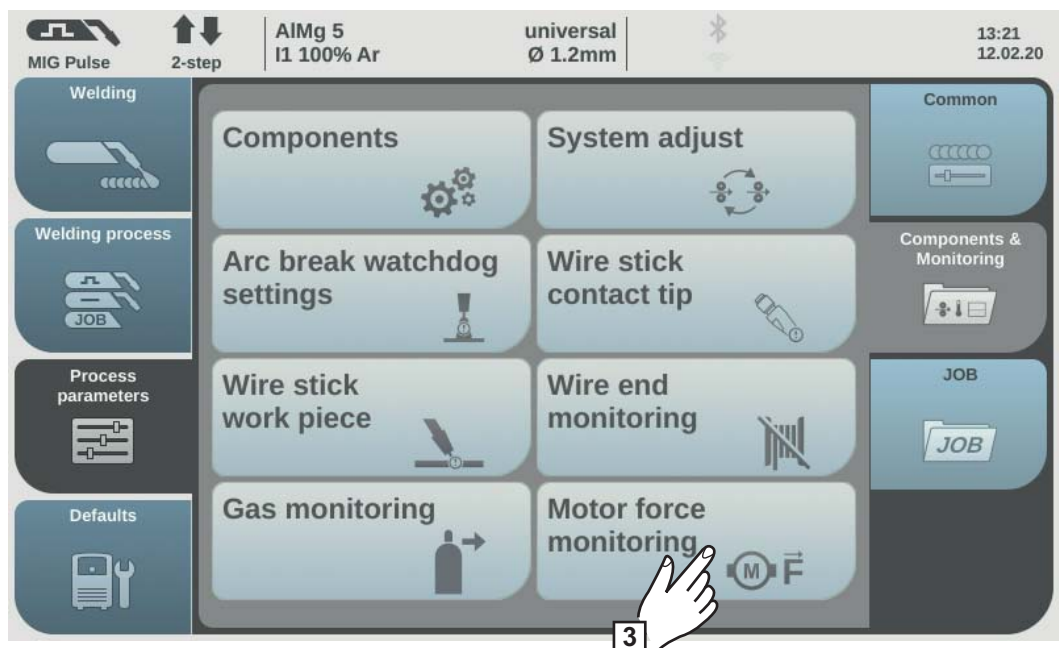

- 3 Select "Motor force monitoring"

The "Motor force monitoring" overview is displayed.

- 4 Turn the adjusting dial and select the desired parameter:

Wire feed force monitoring

Setting range:

Ignore (no response)

Warning (a warning is displayed)

Error (welding process is interrupted, an error message is displayed)

Factory setting: Ignore

Maximum force

Setting range: 0 - 999 N

Factory setting: 0 N

Max. time of force deviation

Setting range: 0.1 - 10.0 s

Factory setting: 3 s

- 5 Press the adjusting dial (blue background)
- 6 Turn the adjusting dial to change the parameter value (blue background)
- 7 Select "OK" to conclude the settings

Process parameters, Job

Optimising job process parameters

The following process parameters can be set for job optimisation:

Job parameters

Trigger mode

for setting the operating mode

2-step / 4-step / S2-step / S4-step / spot welding

Wire Feed Speed

for adjusting the wire speed

e.g. 2 - 25 m/min (ipm)
(depending on wire speed and welding characteristic)

Arclength correction

for correcting the arc length

-10.0 - +10.0

- short arc
0 ... uncorrected arc length
+ ... longer arc

Pulse/dynamic correction

-10.0 - +10.0

For correcting the pulse energy during pulsed arc welding

- ... lower droplet detachment force
0 ... neutral droplet detachment force
+ ... increased droplet detachment force

For influencing the short-circuiting dynamic at the moment of droplet transfer during standard arc welding

- ... harder and more stable arc
0 ... neutral arc
+ ... soft and low-spatter arc

The other adjustable process parameters correspond to the process parameters already described:

Weld-Start/ Weld-End ... see page [116](#)

- Starting current
- Start Arclength correction
- Start current time
- Slope 1
- Slope 2
- End current
- End Arclength correction
- End current time
- SFI
- SFI Hot start
- Wire retract

Spot welding ... see page [129](#)

- Spot welding time

Process control ... see page [118](#)

- Penetration stabilizer
- Arc length stabilizer

SynchroPulse ... see page [123](#)

- Synchro pulse
- Delta wire feed
- Frequency
- Duty cycle (high)
- Arc length correction high
- Arc length correction low

Process mix ... see page [125](#)

- High power time corr.
- Low power time corr.
- Low power corr.

CMT Cycle Step ... see page [128](#)

Only if the OPT/i CMT Cycle Step option is present on the power source.

- CMT Cycle Step
- Cycles (Spot size)
- Interval break time
- Interval cycles

Gas-Setup ... see page [117](#)

- Gas preflow
- Gas postflow
- Command value gas
- Gas factor

Job slope ... see page [149](#)

- Job slope

Documentation ... see page [176](#)

- Sampling rate
off / 0.1–100.0 s
Factory setting off

Limit Monitoring

(only in conjunction with the OPT/i Limit Monitoring option)

- Voltage command value
- lower voltage limit
- upper voltage limit
- Max. time of voltage deviation
- Current command value
- lower current limit
- upper current limit
- Max. time of current deviation
- Wfs command value
- lower wfs limit
- upper wfs limit
- Max. time of wfs deviation
- Welding duration command value Lower welding duration limit
- Upper welding duration limit
- Welding time monitoring
- Energy command value
- Lower energy limit
- Upper energy limit
- Energy monitoring
- Limit reaction

Components ... see page [134](#)

- Inching value

Further information on optimising jobs can be found in the "Welding mode" section, under "Job Mode" on page [95](#).

Process parameters for correction limits

The following process parameters can be set for the job correction limits:

Power

Upper power limit

For setting the upper power limit for a job

0 - 20%

Factory setting: 0%

Lower power limit

For setting the lower power limit for a job

-20 - 0%

Factory setting: 0%

Arc length correction

Upper arc length correction Limit

for setting the upper arc length correction limit for a job

0.0 - 10.0

Factory setting: 0

Lower arc length correction Limit

for setting the lower arc length correction limit for a job

-10.0 - 0.0

Factory setting: 0

Further information on optimising jobs can be found in the Job correction limits section, under Job Mode on page 96.

Process parameters for pre-settings for "Save as Job"

After confirming the displayed information, the following process parameters can be set for the "Save as Job" pre-settings:

Job slope - Pre-settings

Job slope

defines the time between the job that is currently selected and the next job

0.0 - 10.0 s

Factory setting: 0 s

Limit monitoring - Pre-settings

(only in conjunction with the OPT/i Limit Monitoring option)

Lower voltage limit

for setting the lower voltage limit as a function of the set value

-10.0 - 0.0 V

Factory setting: 0 V

Upper voltage limit

for setting the upper voltage limit as a function of the set value

0.0 - 10.0 V

Factory setting: 0 V

Max. time of voltage deviation

for setting the maximum duration of a voltage deviation

off / 0.1 - 10.0 s

Factory setting: off

Lower current limit

for setting the lower current limit as a function of the set value

-100.0 - 0.0 A

Factory setting: 0

Upper current limit

for setting the upper current limit as a function of the set value

0.0 - 100.0 A

Factory setting: 0

Max. time of current deviation

for setting the maximum duration of a current deviation

off / 0.1 - 10.0 s

Factory setting: off

Lower wfs limit

for setting the lower wire speed limit

-10.0 - 0.0 m/min (ipm)
Factory setting: 0 m/min

Upper wfs limit

for setting the upper wire speed limit

0.0 - 10.0 m/min (ipm)
Factory setting: 0 m/min

Max. time of wfs deviation

for setting the maximum duration of a wire speed deviation

off / 0.1 - 10.0 s
Factory setting: off

Welding duration command value

for setting the welding time

0.0 - max s
Factory setting: 0.0

Lower welding duration limit

for setting the lower welding duration limit

0.0 ... -50.0 s
Factory setting: 1.0

Upper welding duration limit

for setting the upper welding duration limit

0.0 - 50.0 s
Factory setting: 1.0

Welding duration monitoring

to enable/disable welding duration monitoring

on / off
Factory setting: on

Energy command value

for setting the energy command value

0.0 - max. kJ
Factory setting: 1.0

Lower energy limit

for setting the lower energy limit

0.0 ... -max
Factory setting: -1.0

Upper energy limit

for setting the upper energy limit

0.0 - max
Factory setting: 1.0

Energy monitoring

to enable/disable energy monitoring

on / off
Factory setting: on

Limit reaction

for setting the reaction if the limit values are exceeded or undercut

Ignore / Warning / Error

Factory setting: Ignore

Ignore

Limit values will not be monitored or logged in the logbook

Warning

If the limit values are exceeded or undercut, a warning will show on the display and the welding process will not be interrupted.

Error

If the limit values are exceeded or undercut, the welding process will stop immediately and an error message will show on the display.

Defaults

General remarks

NOTE!

As a result of firmware updates, you may find that there are functions available on your unit that are not described in these operating instructions or vice versa. Certain illustrations may also differ slightly from the actual control elements on your device. However, these controls function in exactly the same way.

WARNING!

Operating the equipment incorrectly can cause serious injury and damage.

- ▶ Do not use the functions described until you have thoroughly read and understood these operating instructions
- ▶ Do not use the functions described until you have thoroughly read and understood all the operating instructions for the system components, especially the safety rules

Overview

"Defaults" contains the following options:

Under the "View" button

Language
Time & Date
System data

Units / Standards
EasyJobs
Synergic lines (characteristics)

Under the "System" button

Information
Website password
Network settings
Wire feeder setup

Restore factory settings
Mode Setup
Power source configurations
Next page

previous page:

Interface setup

Under the "Documentation" button

Basic settings
Limit value monitoring (on / off)

Logbook

Under the "Administration" button

User management

CENTRUM server (on / off)

Defaults - view

Setting the language

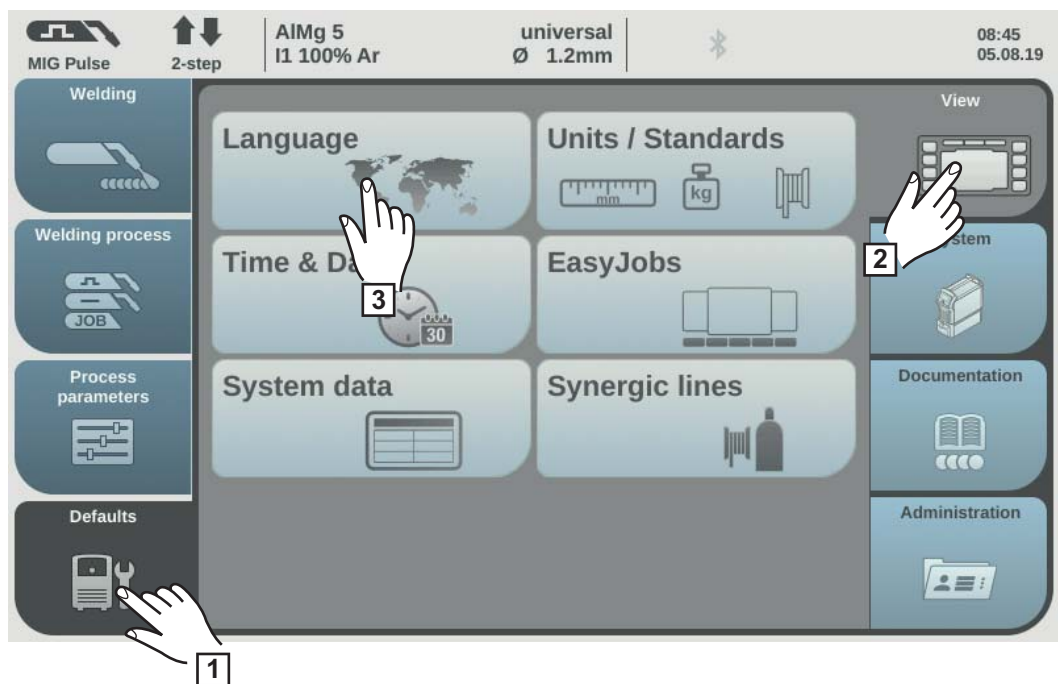

- 1 Select "Defaults"
- 2 Select "View"
- 3 Select "Language"

An overview of the available languages is displayed.

- 4 Turn the adjusting dial and select the desired language
- 5 Select "OK" / press the adjusting dial

The welding parameters are displayed in the selected language.

Setting Units/ Standards

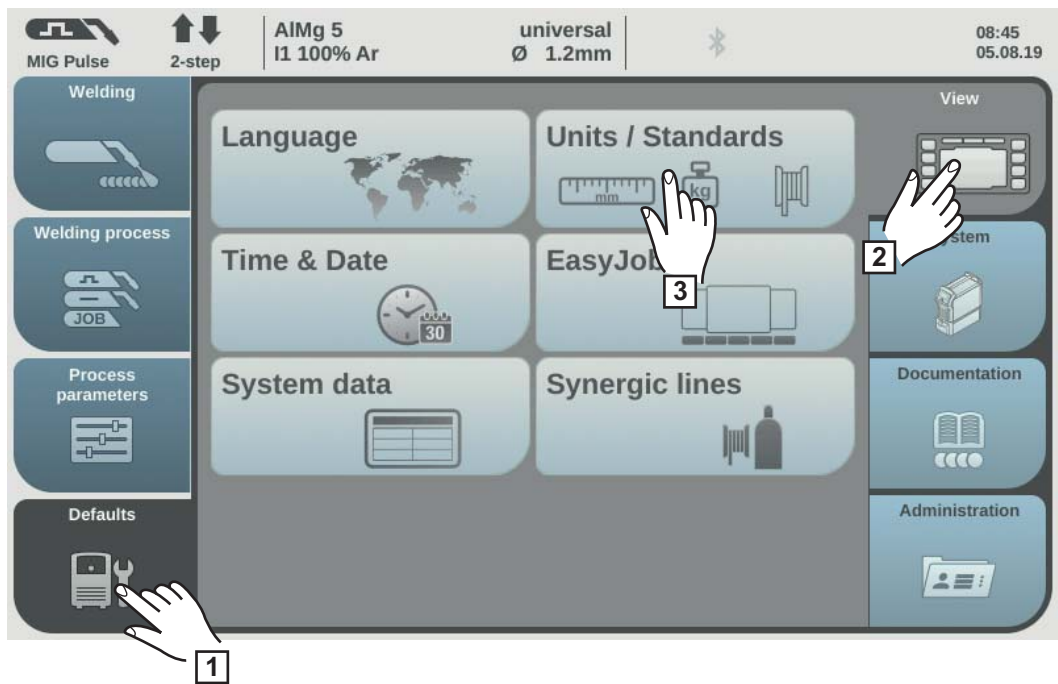

- 1** Select "Defaults"
- 2** Select "View"
- 3** Select "Units / Standards"

An overview of units and standards is displayed.

- 4** Select the desired unit
- 5** Select the desired standard:

EN
 Name of filler metal according to European standards
 (e.g. AlMg 5, CuSi3, Steel, etc.)

AWS
 Name of filler metal according to the American Welding Standard
 (e.g. ER 5356, ER CuSi-A, ER 70 S-6, etc.)

- 6** Select "OK"

An overview of units and standards is displayed.

Setting the time and date

The time and date can either be set using the NTP (Network Time Protocol) or manually.

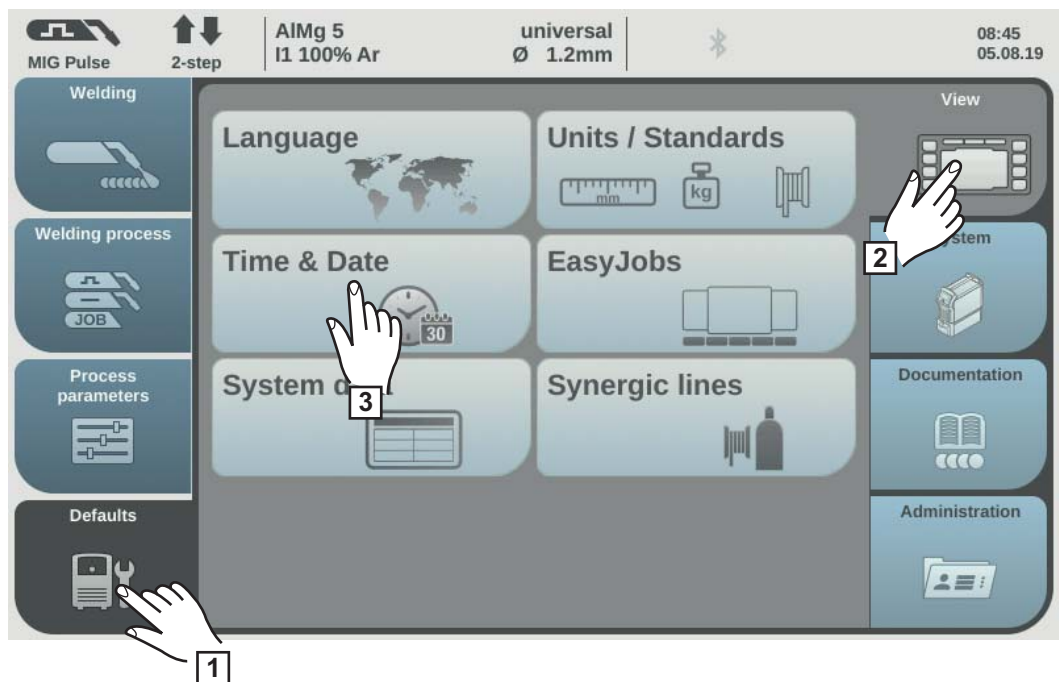

- 1 Select "Defaults"
- 2 Select "View"
- 3 Select "Time & Date"

An overview of the time and date is displayed.

Setting the time and date using the NTP

A DNS server must be available, or the network parameters must be configured correctly if setting the time and date manually (see "Setting network parameters manually", page 167).

- 4 Select "Date & Time automatically"
- 5 Enter the address of the local time server
Ask your IT administrator for the address of the local time server or use the internet (e.g. pool.ntb.org).
- 6 Enter the time zone
The time zone must correspond to the location of the power source.
- 7 Select "Time server test" to start the time synchronisation

The power source is synchronised with the time on the NTP server. If the NTP has been set up, the time will be synchronised each time the power source is started, as long as a connection to the time server can be established.

- 8 Select "Assign"

Setting the time and date manually

In order to be able to set the time and date manually, "Date & Time automatically" must not be selected.

- 4 Turn the adjusting dial and select the desired parameter:
Year / Month / Day / Hour / Minute
(white background)
- 5 Press the adjusting dial to change the parameter (blue background)
- 6 Turn the adjusting dial and set the desired value (blue background)
- 7 Press the adjusting dial and apply the set value (white background)
- 8 Select "OK" / press the adjusting dial

The default view settings are displayed.

Retrieving system data

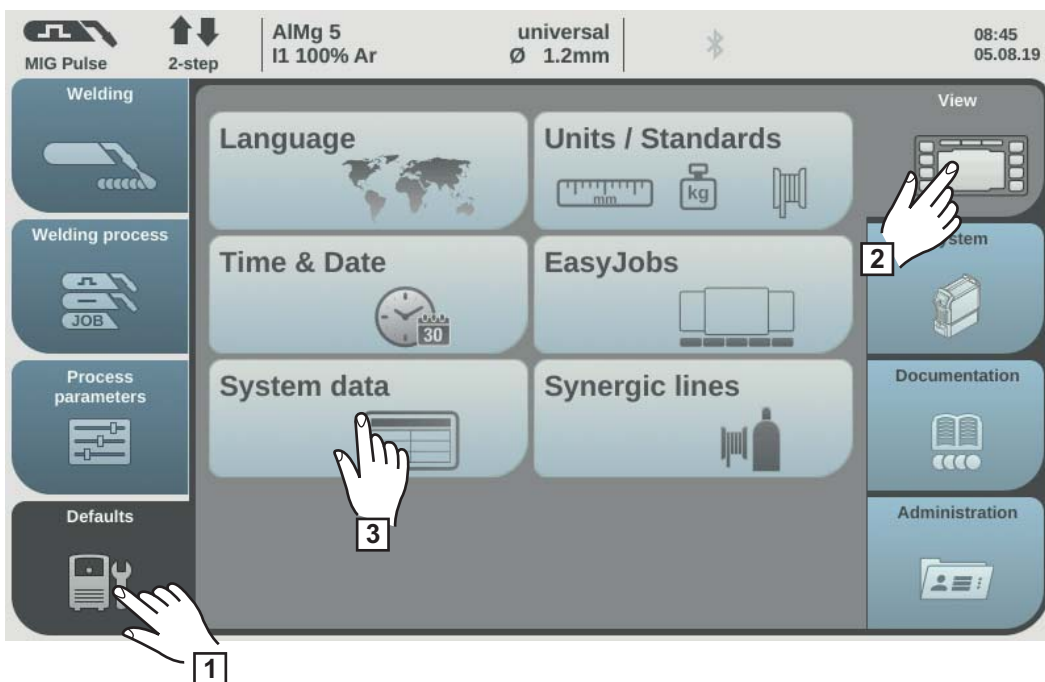

- 1 Select "Defaults"
- 2 Select "View"
- 3 Select "System data"

The current system data is displayed.



Arc power from real-time values in kW

IP delivers the correct mean value of the arc power due to the high sample measuring rate during non-continuous welding processes.

If the welding speed is known, the electrical energy input can be calculated:

$$E = IP / vs$$

E	Electrical energy input in kJ/cm
IP	Arc power in kW
vs	Welding speed in cm/s



Arc energy in kJ

IE delivers the correct total arc energy due to the high sample measuring rate during non-continuous welding processes.

The arc energy is total arc power during the entire welding time.

If the weld seam length is known, the electrical energy input can be calculated:

$$E = IE / L$$

E Electrical energy input in kJ/cm

IE Arc energy in kJ

L Length of the weld seam in cm

The arc energy is preferably used during manual welding to calculate the energy input.

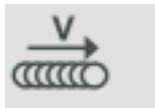

Current welding speed in cm/min



Job currently set



Current weld seam



Current motor current in A, wirefeeder 1
(wirefeeder next to the arc)



Current motor current in A, wirefeeder 2
(e.g. the rear wirefeeder in a push-pull system)



Current motor current in A, wirefeeder 3
(e.g. an unreeling wirefeeder in a push-pull system with unreeling wirefeeder)



Current motor force in N, wirefeeder motor 1



Current motor force in N, wirefeeder motor 2



Current motor force in N, wirefeeder motor 3



Current flow rate in l/min on the cooling unit
(with built-in OPT/i CU flow temperature sensor option)

Error output if flow rate < 0.7 l/min



Current shielding gas flow rate
(with OPT/i gas controller option present)



Total shielding gas consumption
(with OPT/i gas controller option present)



Current coolant temperature in °C on the cooling unit
(with built-in OPT/i CU flow temperature sensor option)

Error output if coolant temperature > 70 °C
(measured during coolant return)



Arc time in h



Total power source operating hours in h

- 4 Select "OK" to exit the system data

The default view settings are displayed.

Displaying characteristics

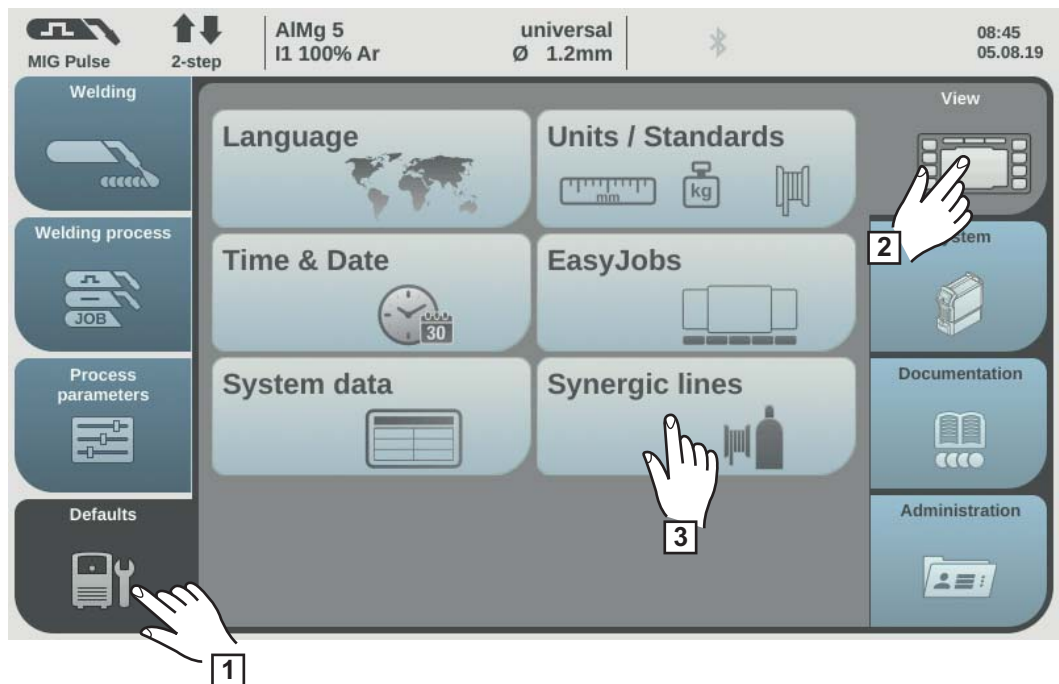

- 1 Select "Defaults"
- 2 Select "View"
- 3 Select "Synergic lines"

The options for displaying the characteristics are displayed.

- 4 Select desired display option

Hide replaced synergic lines:

Only the current characteristics are displayed in the material settings.

Display replaced synergic lines:

Older characteristics that have been replaced are also displayed in the material settings, as well as the current characteristics. These can also be selected while setting the material settings.

- 5 Select "OK"

The default view settings are displayed.

Defaults - System

Retrieving device information

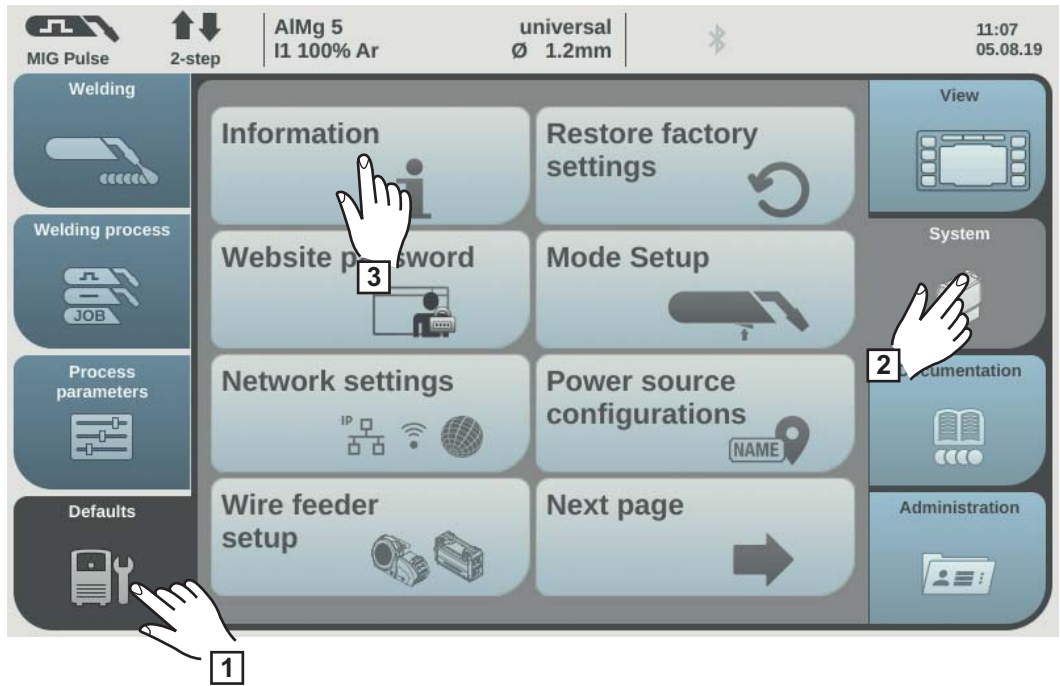

- 1 Select "Defaults"
- 2 Select "System"
- 3 Select "Information"

The device information is displayed.

- 4 Select "OK"

Restoring factory settings

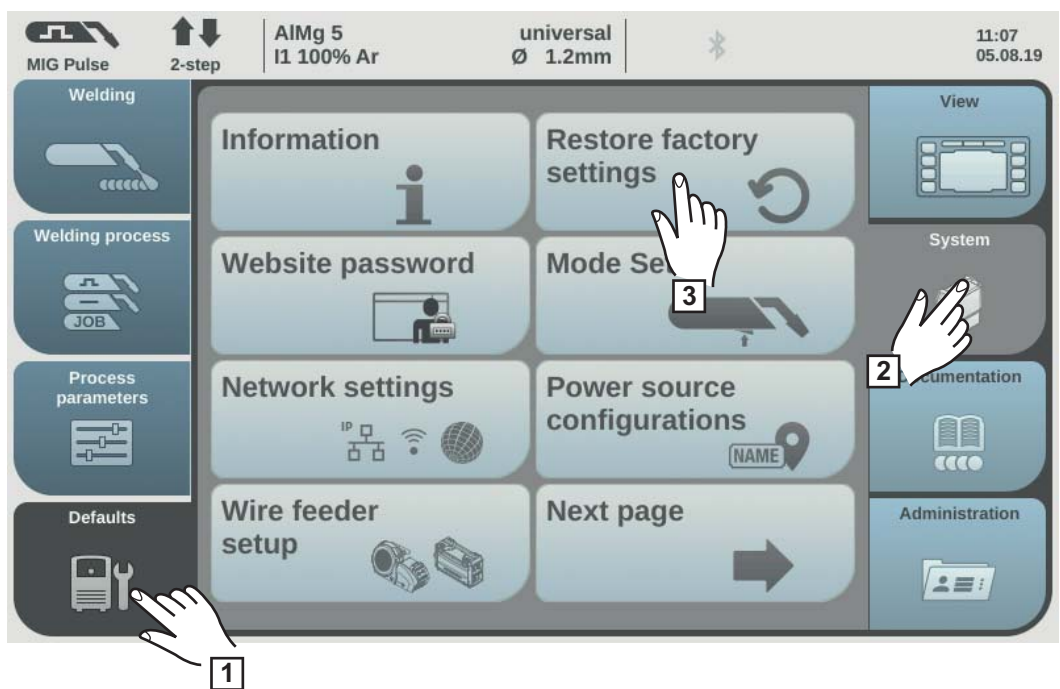

- 1 Select "Defaults"
- 2 Select "System"
- 3 Select "Restore factory settings"

A confirmation prompt for the factory settings is displayed.

- 4 Select "Yes" to reset the values to their factory settings

The process parameters and machine preset values are reset to the factory settings, an overview of the machine presets is displayed.

Restoring the website password

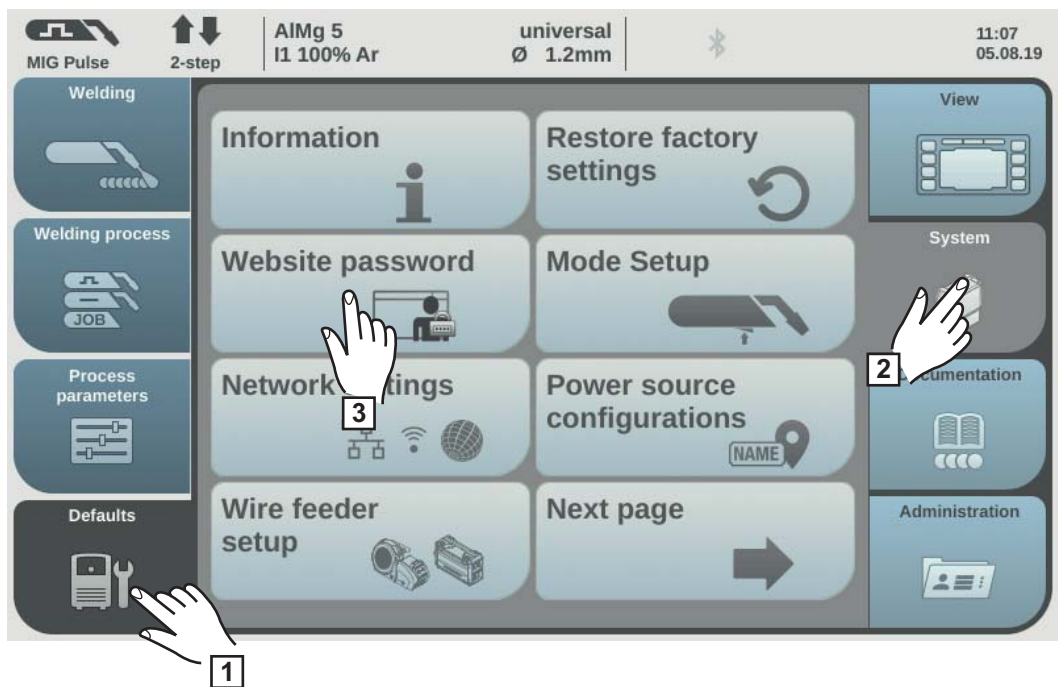

- 1 Select "Defaults"
- 2 Select "System"
- 3 Select "Website password"

A confirmation prompt asking whether you really want to reset the website password is displayed.

- 4 Select "Yes" to reset the website password

The website password is reset to the factory setting:
 User name = admin
 Password = admin

The system overview of the default settings is displayed.

Mode Setup: Setting the special 4-step mode "Guntrigger", special display for JobMaster, spot welding and torch trigger job selection

In the default settings, the following special functions can be set under "Mode Setup":

- Special 4-step mode "Guntrigger" for a JobMaster welding torch *
- JobMaster special display for a JobMaster welding torch *
- 2-step or 4-step mode for spot welding
- Torch trigger job selection for a welding torch

* Only if the OPT/i GUN Trigger option is available on the power source.

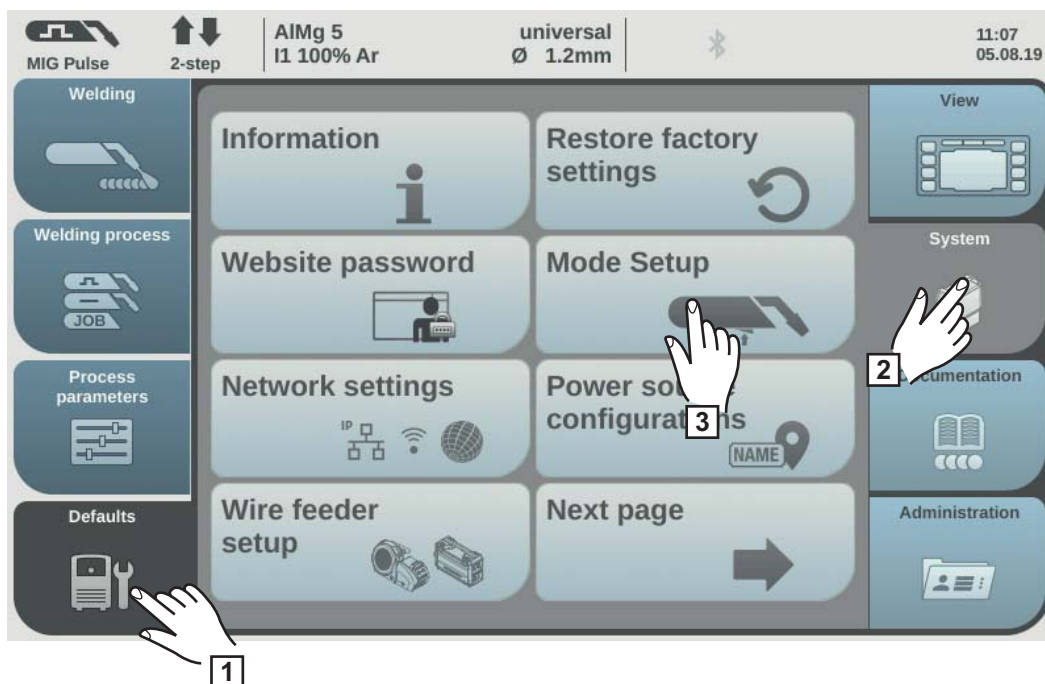

- 1 Select "Defaults"
- 2 Select "System"
- 3 Select "Mode Setup"

The "Mode Setup" overview appears.

- 4 Turn the adjusting dial and select the desired special function (white background)
- 5 Press the adjusting dial (blue background)
- 6 Turn the adjusting dial to activate/deactivate the special function
- 7 Select "OK"

The default settings are displayed.

Special 4-step mode = Guntrigger

With a JobMaster welding torch and with special 4-step mode selected, this function allows you to change jobs via the torch trigger during welding. Job changing takes place within defined job groups.

A job group is defined by the next non-programmed job.

Example:

Job group 1: Job no. 3 / 4 / 5

Job no. 6 is not assigned ==> End of job group 1

Job group 2: Job no. 7 / 8 / 9

- When welding starts, the job with the lowest number within the job group is automatically selected.
- To change to the job with the next highest number within a job group, press the torch trigger briefly (< 0.5 seconds).
- To stop welding, press the torch trigger for more than 0.5 seconds.
- To change to the next job group, press the parameter setting button on the JobMaster welding torch for more than 5 seconds.

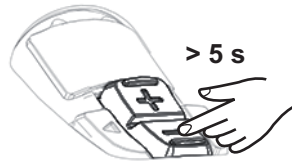

Special display for JobMaster = on

The following can now be set and carried out on the JobMaster welding torch:

- Operating mode
- Synchro pulse
- Gas test

Spot welding

2-step = spot welding in 2-step mode:

The spot welding process runs for as long as the torch trigger is kept pressed and ends no later than at the expiry of the spot welding time.

Releasing the torch trigger stops the spot welding process before the spot welding time expires.

4-step = spot welding in 4-step mode:

The spot welding process starts once the torch trigger is pressed and ends no later than at the expiry of the spot welding time.

Press the torch trigger again to stop the spot welding process before the spot welding time expires.

More information on spot welding:

- Page [100](#) (spot welding in general)
- Page [129](#) (spot welding time)

Torch trigger job selection = on

This function allows the user to change to the next job using the torch trigger. Job changing takes place within defined job groups.

A job group is defined by the next non-programmed job.

Example:

Job group 1: Job no. 3 / 4 / 5

Job no. 6 is not assigned ==> End of job group 1

Job group 2: Job no. 7 / 8 / 9

- When welding starts, the job with the lowest number within the job group is automatically selected.
- To change to the job with the next highest number within a job group, press the torch trigger briefly (< 0.5 seconds).
- To stop welding, press the torch trigger for more than 0.5 seconds.
- To switch to the next job group, press the torch trigger briefly twice (< 0.3 s, 2 x).

You can switch jobs when the device is in standby or during welding.

Setting network parameters manually

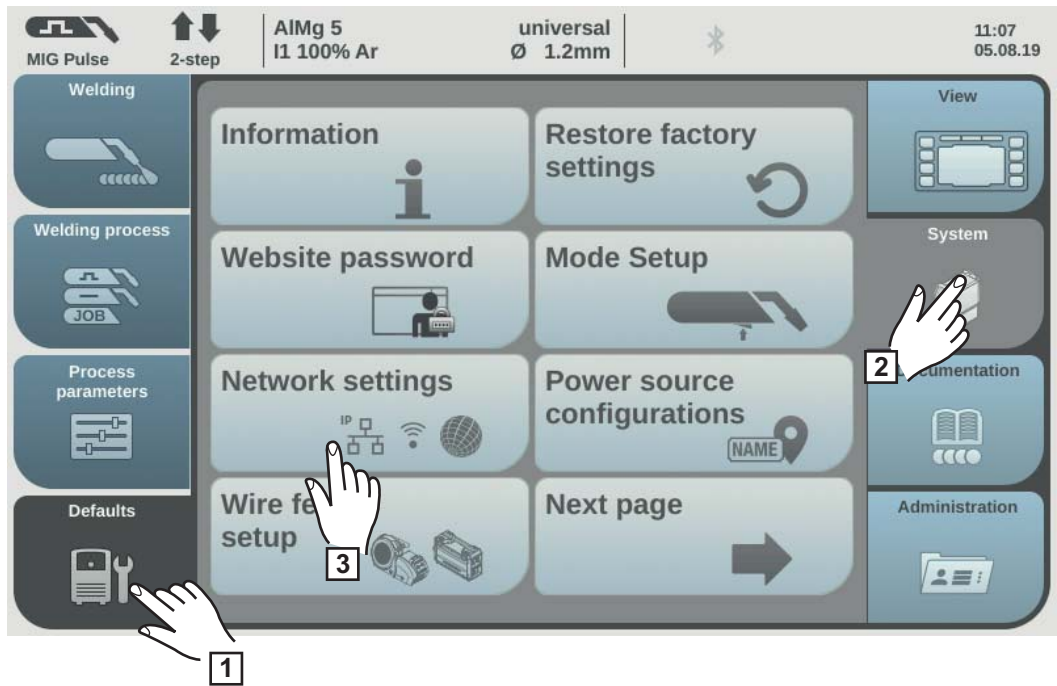

- 1** Select "Defaults"
- 2** Select "System"
- 3** Select "Network Settings"

The network settings will be displayed:

- Network
- WI-Fi
- Bluetooth setup

- 4** Select network

The network setup overview is displayed.

If DHCP is enabled, the IP address, Network mask and Standard gateway network parameters are greyed out and cannot be adjusted.

- 5** Turn the adjusting dial and select "DHCP"
- 6** Press the adjusting dial

DHCP is disabled, the network parameters can now be set.

- 7** Turn the adjusting dial and select the desired network parameter
- 8** Press the adjusting dial

The numerical pad for the selected network parameter is displayed.

- 9** Enter a value for the network parameter
- 10** Select "OK" and confirm the value for the network parameter / press the adjusting dial

The value for the network parameter is applied, the network setup overview is displayed.

- 11** Select "Store" to apply changes to the network setup

Setting up the WLAN

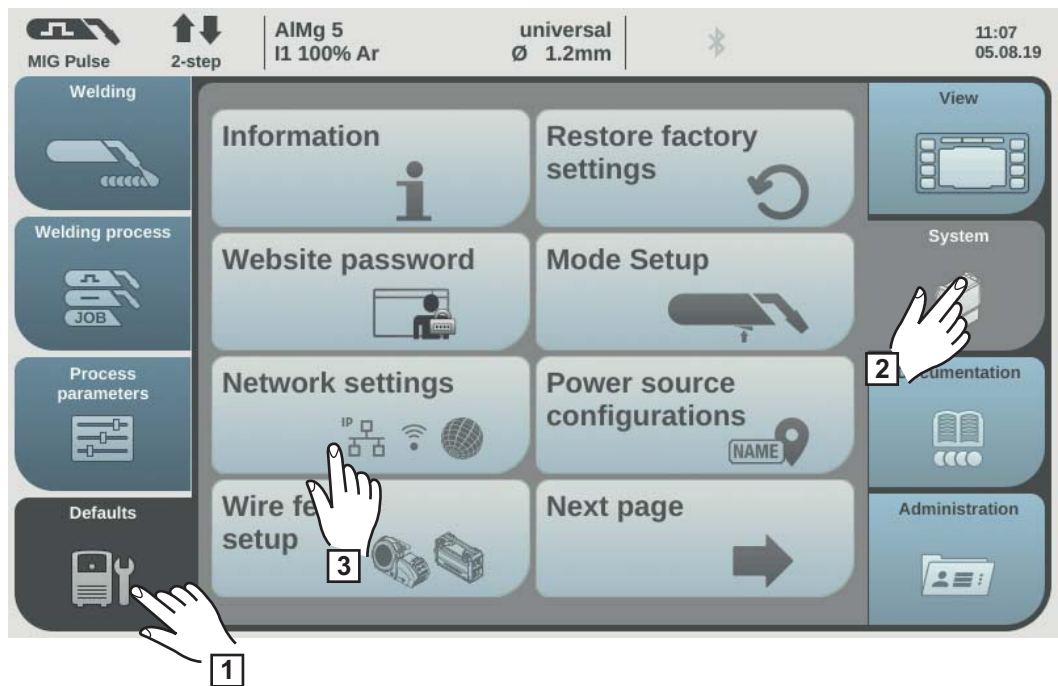

- 1 Select "Defaults"
- 2 Select "System"
- 3 Select "Network settings"

The network settings will be displayed:

- Network
- WI-Fi
- Bluetooth setup

- 4 Select Wi-Fi

The WLAN setup overview is displayed.

Setup country code

- 1 Select "Setup country code"
- 2 Press the adjusting dial
- 3 Turn the adjusting dial and select the corresponding country
- 4 Select "OK"

Activating WLAN

- 1 Select "Enable WI-Fi"

When WLAN is enabled, a check mark appears in the button and the "Add network" and "Delete network" buttons are active.

Adding a network

- 1 Select "Add network"

The available WLAN networks are displayed.

- 2 Turn the adjusting dial and select the desired WLAN network
- 3 Press the adjusting dial or select "Insert"

- 4 Enter data:
 - Enable DHCP
 - or
 - Manually enter IP address, network mask, standard gateway, DNS Server 1 and DNS Server 2:
Turn the dial and select the desired element,
press the setting dial,
enter the data using the numeric keypad,
confirm with "OK"
- 5 Select "OK" and add as WLAN network

Deleting a network

- 1 Turn the adjusting dial and select the WLAN network to be deleted
- 2 Select "Delete network"
- 3 Confirm security prompt

The WLAN network will be deleted.

Bluetooth setup

General

Each Bluetooth user has its own MAC address. This MAC address can be used to assign the devices to specific power sources, preventing mix-ups.

The power source is able to communicate with the following devices:

- Remote control RC Panel Basic /BT
- Pedal remote control RC Pedal TIG /BT
- Welding helmet Vizor Connect /BT

An active Bluetooth connection is indicated in the status bar on the display when the Bluetooth symbol lights up blue.

For safety reasons, when using Bluetooth devices of the same type, only one device can be actively connected to the power source.

It is possible to establish multiple active Bluetooth connections when using Bluetooth devices of different types.

An existing, active Bluetooth connection cannot be interrupted or influenced by another Bluetooth user.

Bluetooth remote controls have priority over wired remote controls or welding torches with control functions.

If the connection between a wired or Bluetooth remote control and the power source is interrupted during the welding process, the welding process is ended.

Running Bluetooth setup

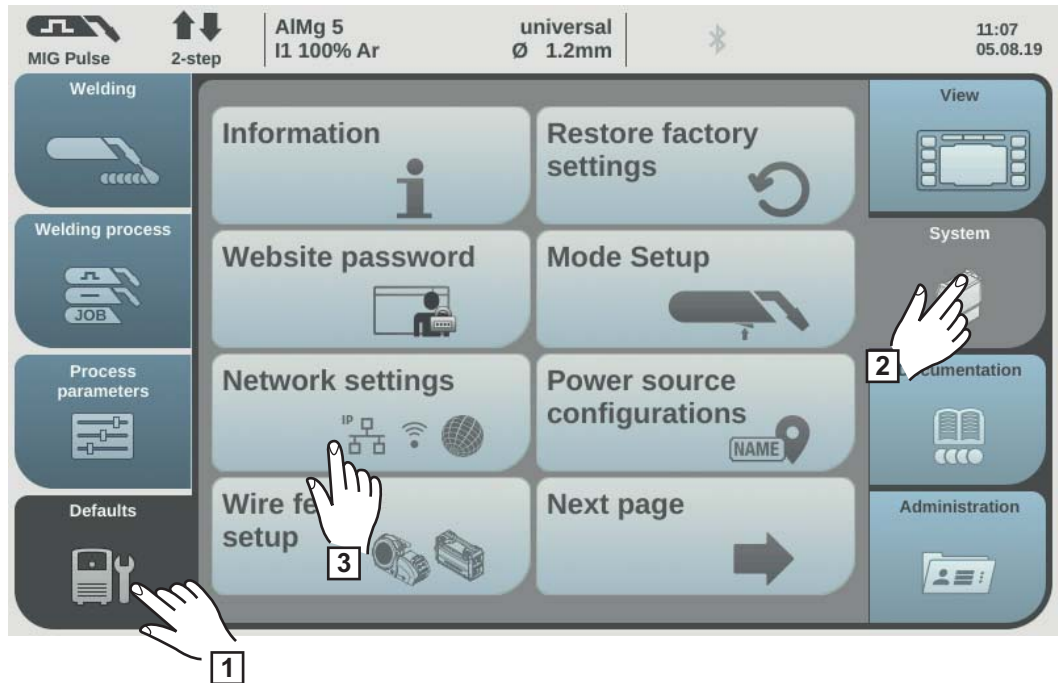

- 1 Select "Defaults"
- 2 Select "System"
- 3 Select "Network settings"

The network settings will be displayed:

- Network
- Wi-Fi
- Bluetooth setup

- 4 Select "Bluetooth setup"

Bluetooth setup is displayed.

Activating or deactivating the power source Bluetooth function

- Select the "enable bluetooth" button

Adding a Bluetooth device

- Switch on the Bluetooth device
- Select the "Add device" button

All Bluetooth devices detected are displayed in a list along with their names, MAC addresses and additional information.

- Use the adjusting dial to select the desired Bluetooth device
- Compare the MAC address displayed with the MAC address on the device
- Select the "Insert" button to establish an active connection to the selected device
- Select the "Store" button

The active connection is displayed under Info.

Symbols displayed under Info:



Active Bluetooth connection

An active change can be made to the power source via the Bluetooth device. Depending on the availability of the data, additional information is also displayed, such as the battery status, signal strength, etc. of the Bluetooth device.



Paired

The Bluetooth device has already been actively connected to a power source at least once and appears in the list of the Bluetooth devices.



Inactive

A new Bluetooth device has been detected or the Bluetooth device was removed by the user.

Deleting the Bluetooth device

- Use the adjusting dial to select the Bluetooth device to be deleted
- Select the "Delete device" button
- When prompted, confirm that you want to delete the device with "OK"

5 Select "OK" to exit Bluetooth setup

Power source configurations

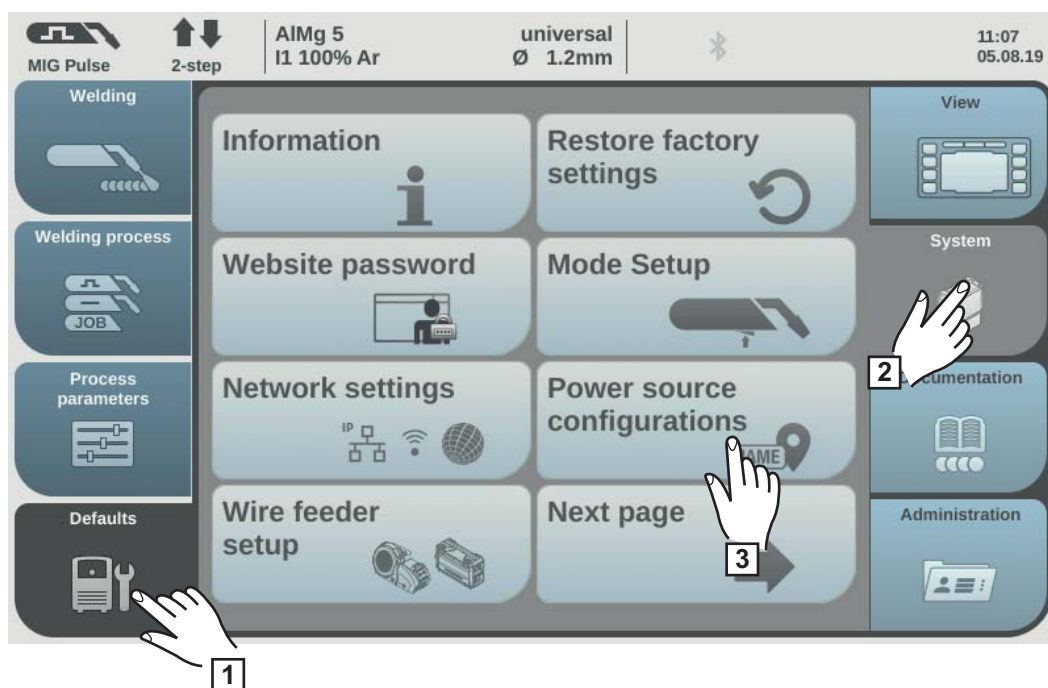

- 1 Select "Defaults"
- 2 Select "System"
- 3 Select "Power source configurations"

The power source configuration is displayed.

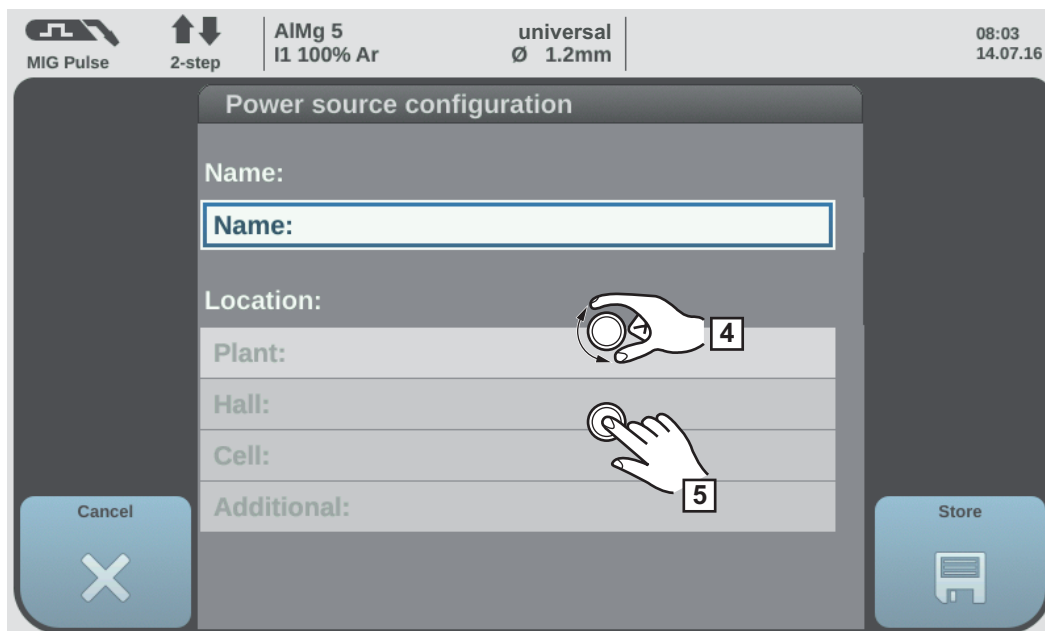

- 4 Turn the adjusting dial and select a configuration location
- 5 Press the adjusting dial

The keyboard is displayed.

- 6 Use the keyboard to enter the desired text (max. 20 characters)
- 7 Select "OK" to confirm the text / press the adjusting dial

The text is applied and the power source configuration is displayed.

- 8 Select "Store" to apply changes

Wire feeder setup Use "Wire feeder setup" to activate or deactivate potentiometers on a wirefeeder.

Not relevant for TPS 320i C.

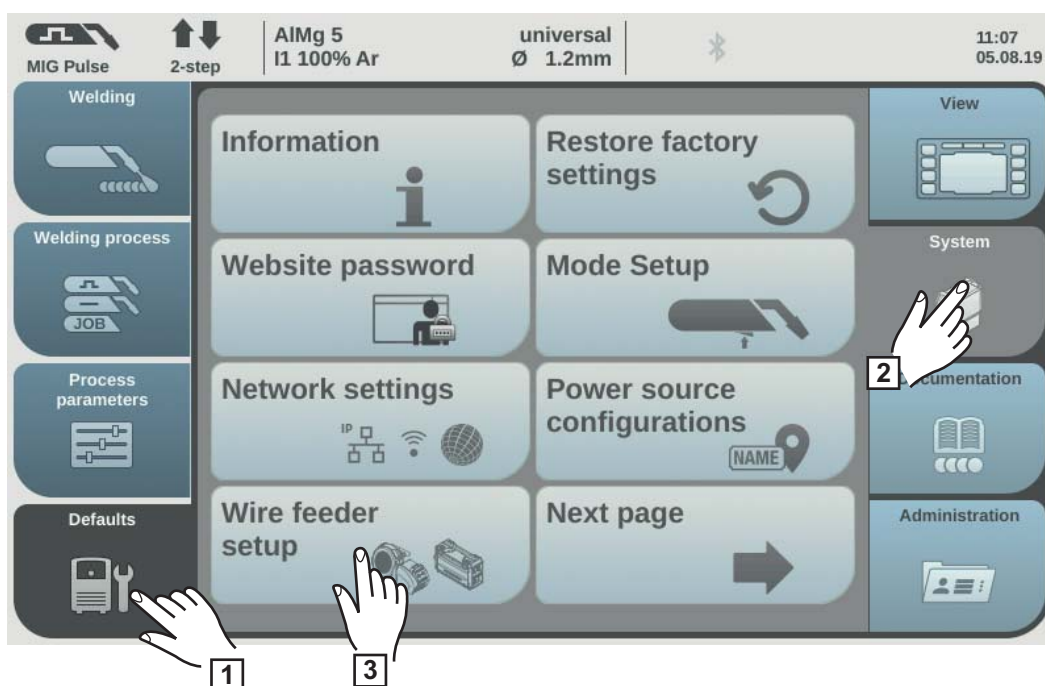

Interface setup

Interface setup can be used to specify whether the welding parameters will be determined externally by the robot control or internally by the power source.

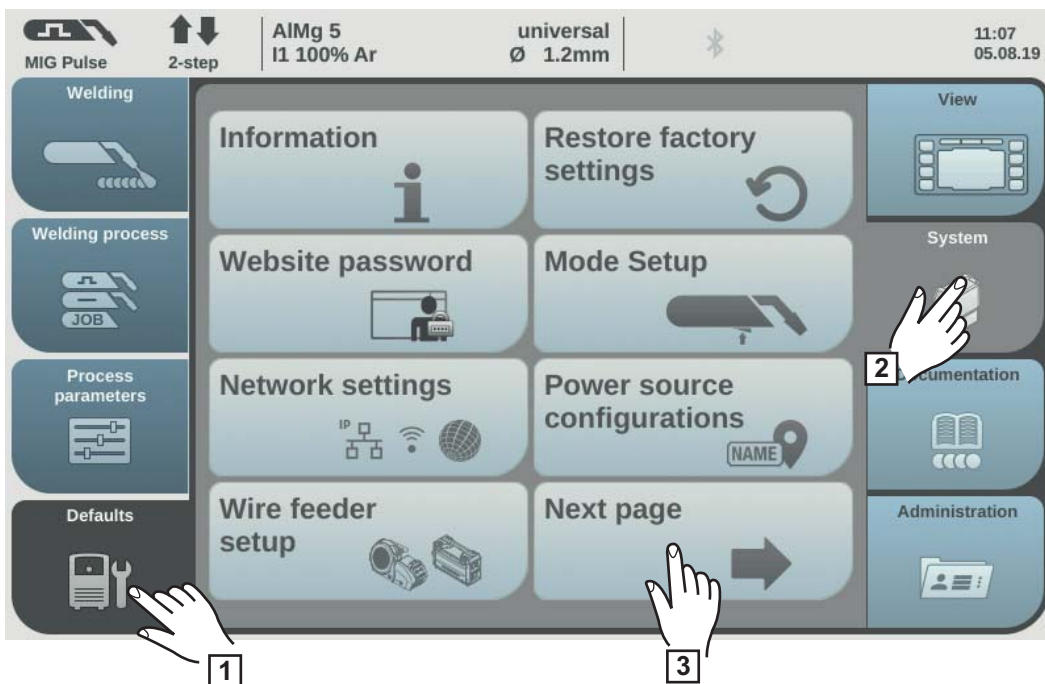

- 1 Select "Defaults"
- 2 Select "System"
- 3 Select "Next page"

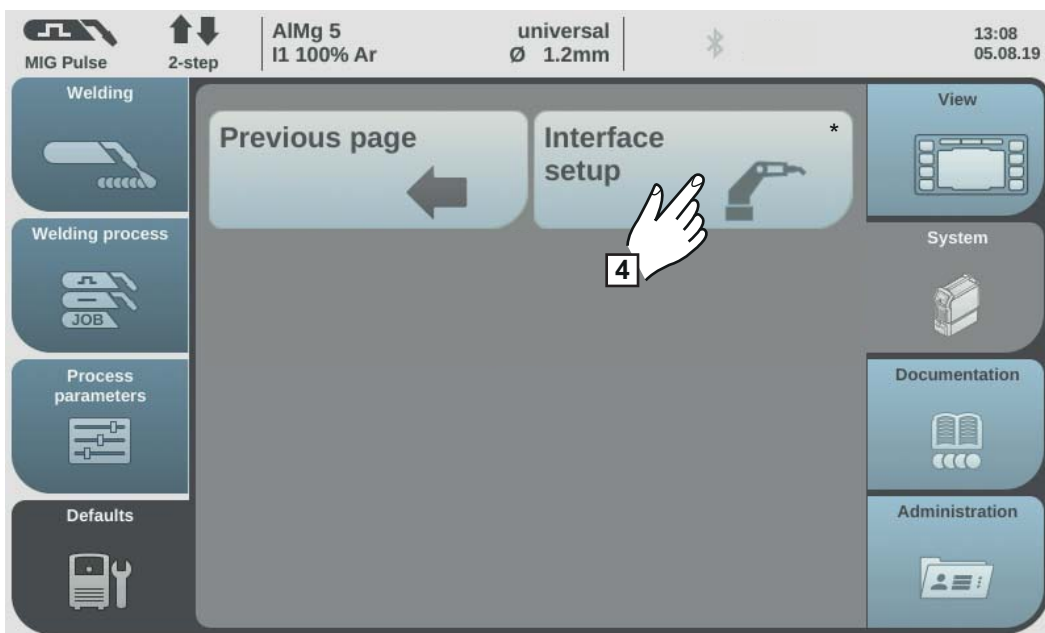

* Depending on the configuration of the power source, the "Interface setup" button can already be displayed on the previous page.

- 4 Select "Interface setup"

5 Set the "Welding parameter" to "External" or "Internal"

External:

All parameter settings are controlled using the robot control (even the welding parameters).

Internal:

The welding parameters are set using the power source, the control signals are routed through the robot control.

Factory setting:

External

Defaults - Documentation

Setting the sampling rate

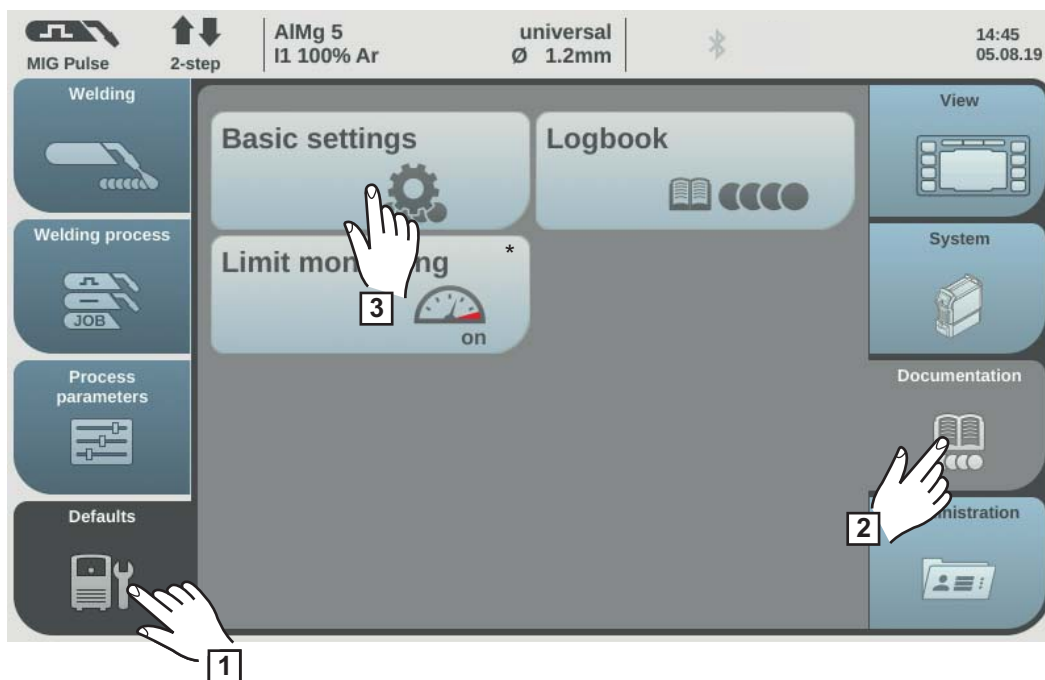

* Only in conjunction with the OPT/i limit monitoring option

- 1 Select "Defaults"
- 2 Select "Documentation"
- 3 Select "Basic settings"

The basic settings documentation is displayed.

- 4 Press the adjusting dial
- 5 Turn the adjusting dial and change the sampling rate value:

off
Sampling rate is deactivated; only average values are stored.

0.1–100.0 s
Documentation is stored with the set sampling rate.

- 6 Select "OK" to confirm the sampling rate

The documentation overview is displayed.

Viewing the logbook

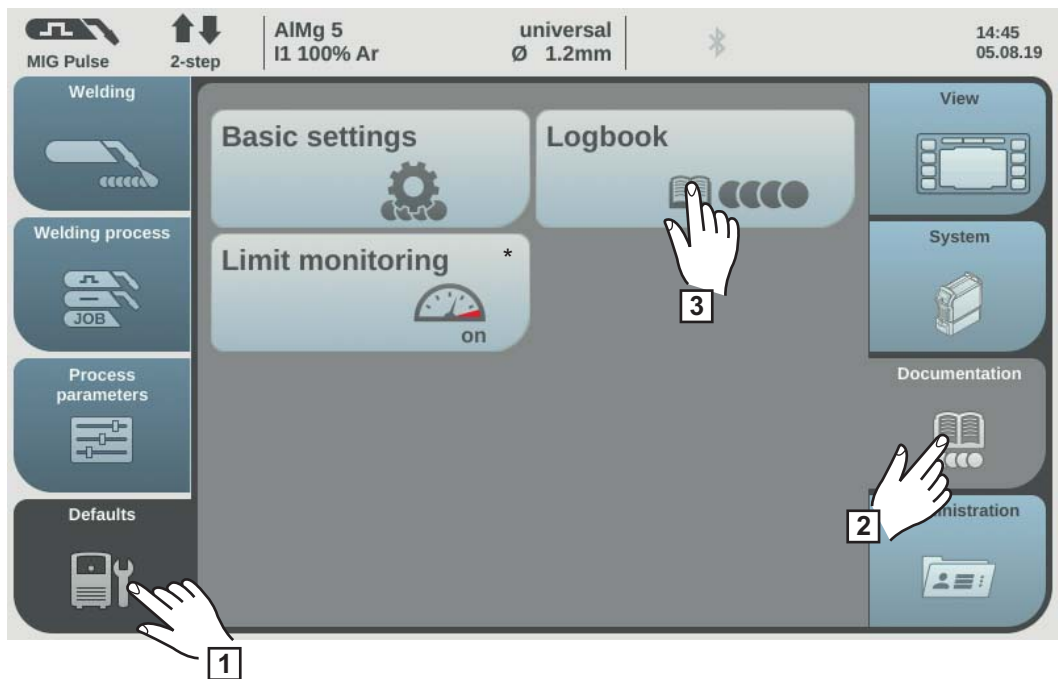

* Only in conjunction with the OPT/i limit monitoring option

- 1 Select "Defaults"
- 2 Select "Documentation"
- 3 Select "Logbook"

The logbook is displayed.

Welding operations, events, errors, warnings or notifications can be displayed using the respective buttons.

The following data is also logged:

(1)	(2)	(3)	(4)	(5)	(6)	(7)	(8)	(9)
No.	ddmmyy	hhmmss	s	A	V	m/min	kJ	Job No.

- (1) Welding operation number
- (2) Date (ddmmyy)
- (3) Time (hhmmss)
- (4) Welding duration in s
- (5) Welding current in A (average value)
- (6) Welding voltage in V (average value)
- (7) Wire speed in m/min
- (8) Arc energy in kJ (for details see page 160)
- (9) Job no.

Turn the adjusting dial to scroll through the list.
Pressing the adjusting dial displays details of a logbook entry.

Details for welds:

									
Section	s	A	V	m/min	cm/min	W	kJ	No.	Process
(10)	(11)	(12)	(13)	(14)	(15)	(16)	(17)	(18)	(19)

- (10) Welding section number
- (11) Duration of the welding section in s
- (12) Welding current in A (average value)
- (13) Welding voltage in V (average value)
- (14) Wire speed in m/min
- (15) Welding speed (cm/min)
- (16) Arc power from real-time values in W (for details see page 159)
- (17) Arc energy in kJ (for details see page 160)
- (18) Job no.
- (19) Process

4 Select "Close" to exit the detailed view

5 Select "OK" to exit the Logbook

Activate/deactivate limit value monitoring

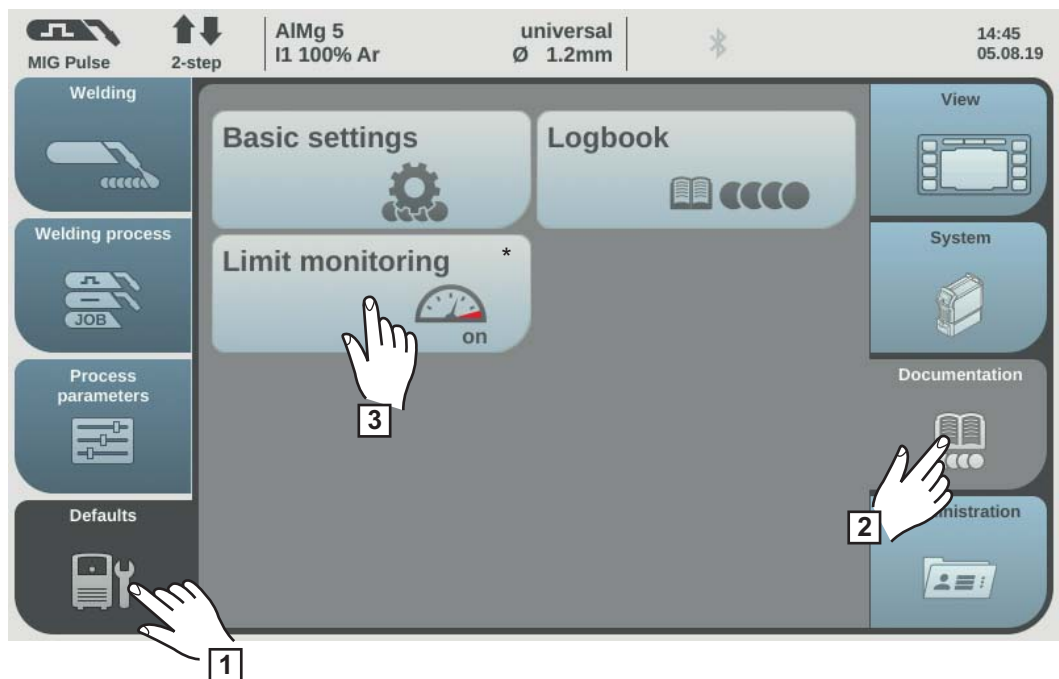

* Only in conjunction with the OPT/i limit monitoring option

1 Select "Defaults"

2 Select "Documentation"

3 Select "Limit monitoring"

The settings for limit value monitoring are displayed.

4 Press the adjusting dial

- 5 Turn the adjusting dial and change the value for limit monitoring:

off:

The limit value monitoring is deactivated.

on:

The limit values will be monitored according to the settings

Factory setting:

off

- 6 Select "OK" to apply the settings for limit value monitoring

The documentation overview is displayed.

Defaults - Administration

General remarks User management is advisable if several users work with the same power source. User management works with different roles and the help of NFC keys.

Users are assigned different roles depending on their level of training or qualifications.

Explanation of terms used

Administrator
An administrator has unlimited access rights to all functions on the power source. The administrator's duties include:

- creating roles,
- editing and managing user data,
- assigning access rights,
- updating the firmware,
- backing up data, etc.

User management
User management encompasses all users registered on the power source. Users are assigned different roles depending on their level of training or qualifications.

NFC card
An NFC card or an NFC key ring is assigned to a certain user who is registered on the power source.
NFC cards and NFC key rings will both be referred to under the general term NFC key for the purpose of these Operating Instructions.

IMPORTANT! Each user should be assigned their own NFC key.

Roles
Roles are used for managing registered users (= user management). Users' access rights and permitted activities are defined by their roles.

Pre-defined roles and users Under Defaults / Administration / User management, 2 roles are predefined as factory settings:

administrator
with full rights and options

The "administrator" role cannot be deleted, renamed or edited.

The "administrator" role is assigned the pre-defined "admin" user, which cannot be deleted. The "admin" user can assign names, languages, units, web passwords and NFC keys.
As soon as "admin" assigns an NFC key, user management is activated.

locked
Factory-set with access to welding processes, but not to process parameters and defaults

The "locked" role

- cannot be deleted or renamed,
- cannot be edited to approve different functions according to demand,

The "locked" role cannot have any NFC keys assigned to it.

If no NFC key is assigned to the pre-defined user "admin", every NFC key will work to lock and unlock the power source (no user management, see "Locking and unlocking the power source using the NFC key", page [70](#)).

Overview

User management consists of the following sections:

- Administrator and creating roles
- Creating a user
- Editing roles / users, deactivating user management

Administrator and creating roles

Recommendation for creating roles and users

Please proceed systematically when creating roles and NFC keys.

Fronius recommends creating one or two administrator keys. Without administrator rights, it may in the worst-case scenario no longer be possible to operate a power source.

Procedure

NOTE!

Losing an NFC administrator key can lead to the power source becoming unusable, depending on the settings. Keep one of the two NFC administrator keys in a safe place.

- 1 Create two equivalent users in the "administrator" role

This means that you will still have access to administrative functions should you lose one of the NFC administrator keys.

- 2 Consider further roles:
 - How many roles are needed?
 - Which rights will be assigned to each role?
 - How many users are there?

- 3 Create roles

- 4 Assign users to roles

- 5 Check that the created users have access to their respective roles with their NFC keys.

Create administrator key

NOTE!
 Once an NFC key is assigned to the pre-defined "admin" user under Defaults / Administration / User management, user management becomes active.

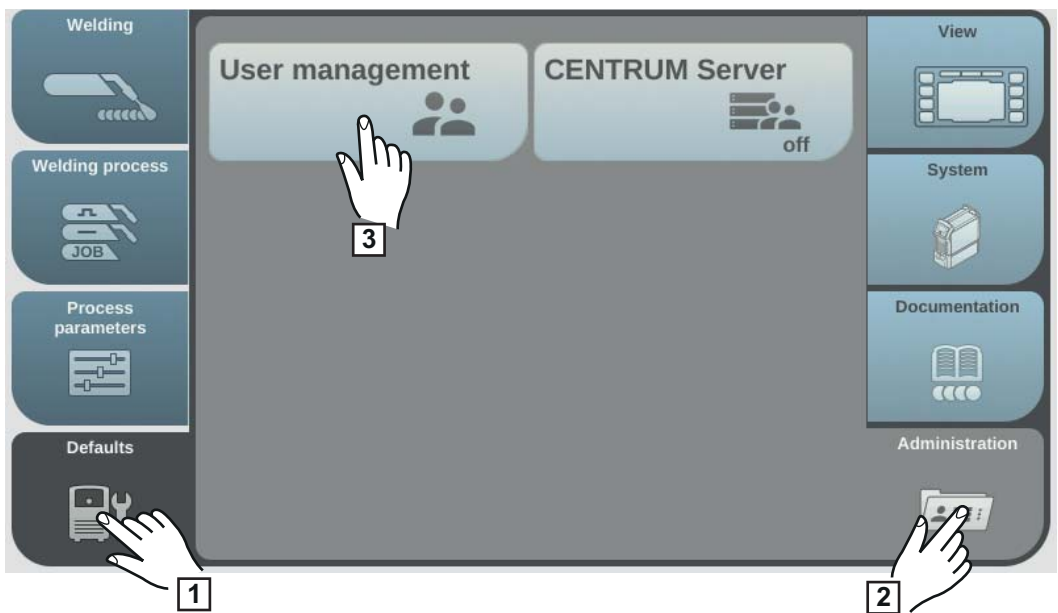

- 1 Select "Defaults"
- 2 Select "Administration"
- 3 Select "User management"

User management is displayed, "administrator" is selected.

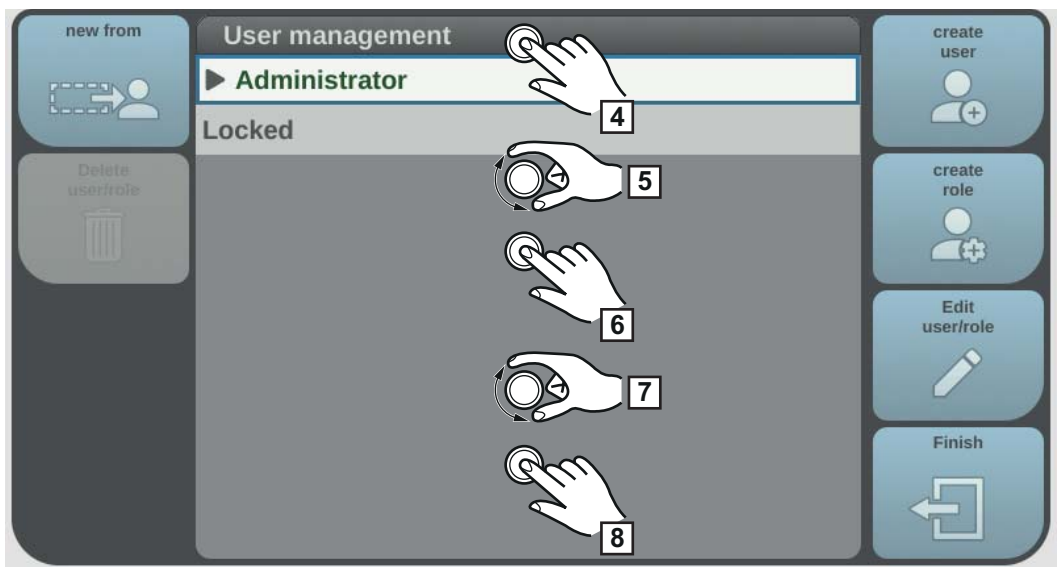

- 4 Press the adjusting dial
- 5 Turn the adjusting dial and select "admin"
- 6 Press the adjusting dial
- 7 Turn the adjusting dial and select "NFC card"
- 8 Press the adjusting dial

The information to be transferred to the NFC card is displayed.

9 Follow the instructions displayed
(hold the new NFC key on the NFC key reader and wait for confirmation of identification)

10 Select "OK"

A note concerning the activated user management is displayed.

11 Select "OK"

Under admin / NFC card, the number of the assigned NFC key is displayed.

To create a second administrator key:

- Copy "admin" (also see page 188 for creating a new key from the selection)
- Enter user name
- Assign new NFC card

Creating roles

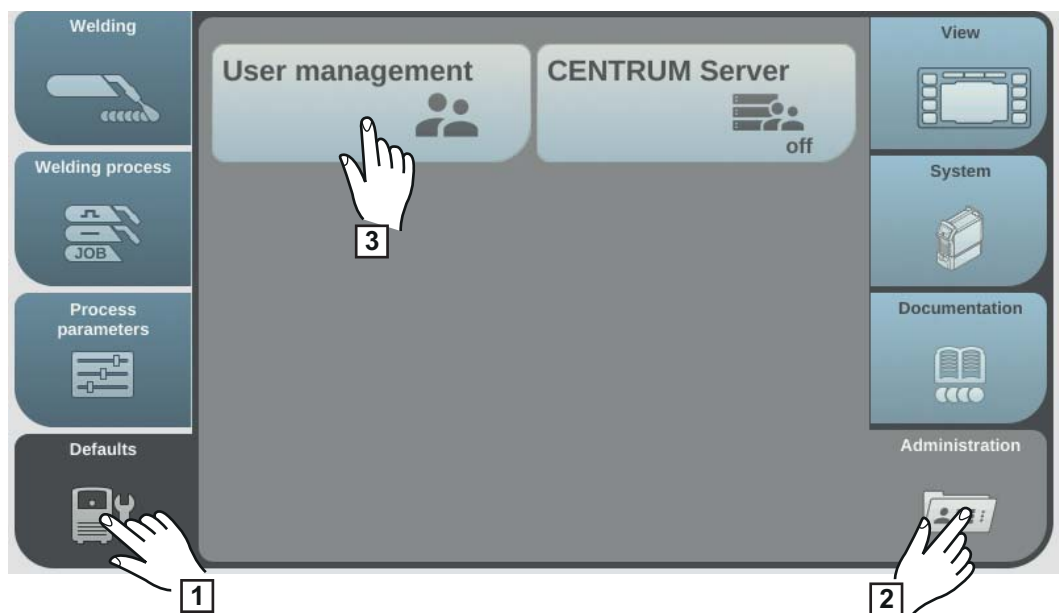

1 Select "Defaults"

2 Select "Administration"

3 Select "User management"

User management appears.

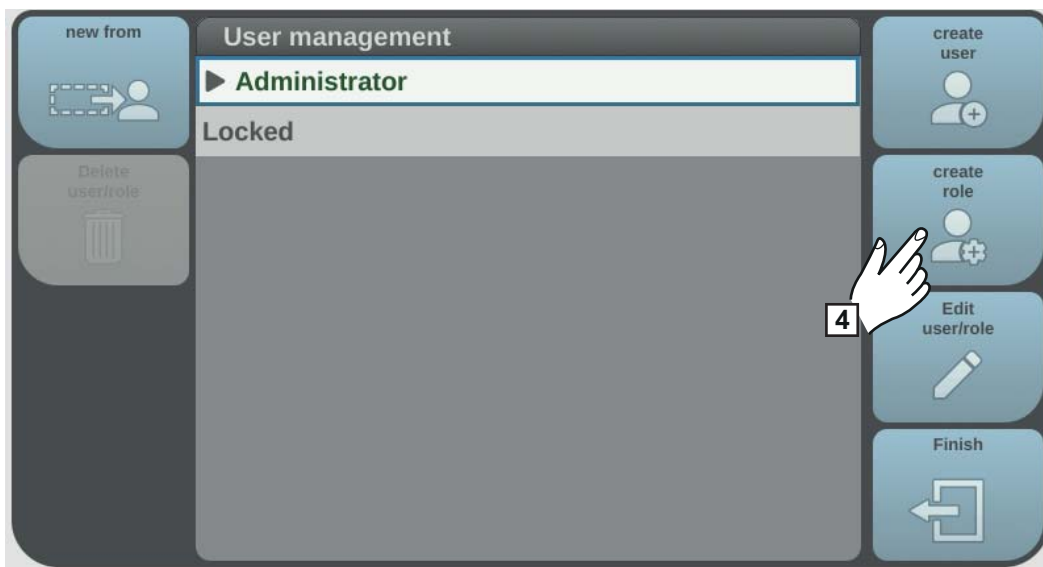

4 Select "create role"

The keyboard is displayed.

5 Use the keyboard to enter the desired role name (max. 20 characters)

6 Select "OK" to apply the role name / press the adjusting dial

The functions that can be executed within a role are displayed.

Symbols:

	...	hidden
	...	read only
	...	read and write

7 Specify the functions that a user can carry out in this role

- Select functions by turning the adjusting dial
- Press the adjusting dial
- Select settings from the list
- Press the adjusting dial

8 Select "OK"

Copy roles

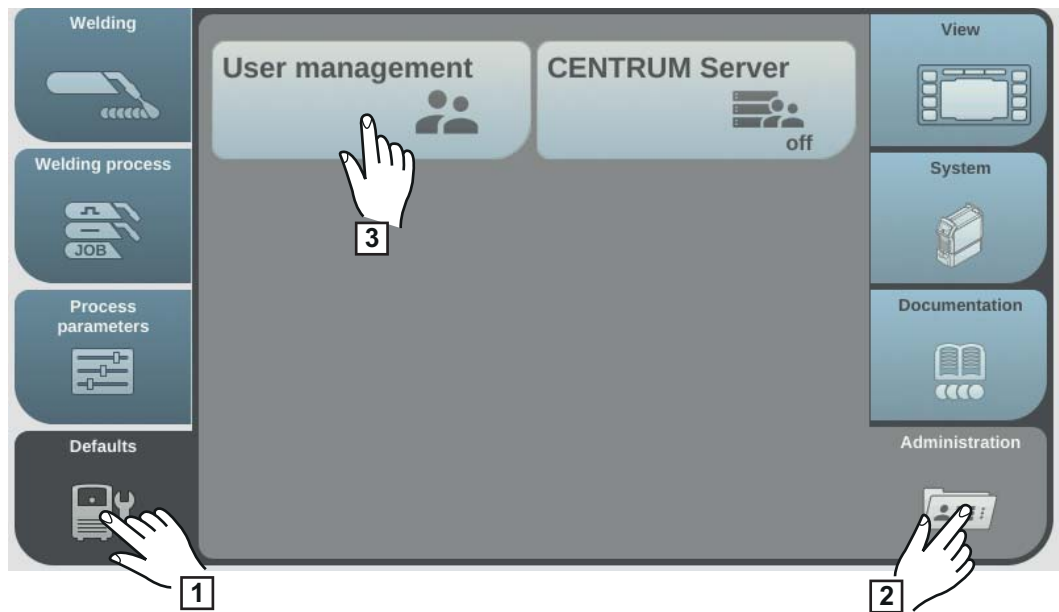

- 1 Select "Defaults"
- 2 Select "Administration"
- 3 Select "User management"

User management appears.

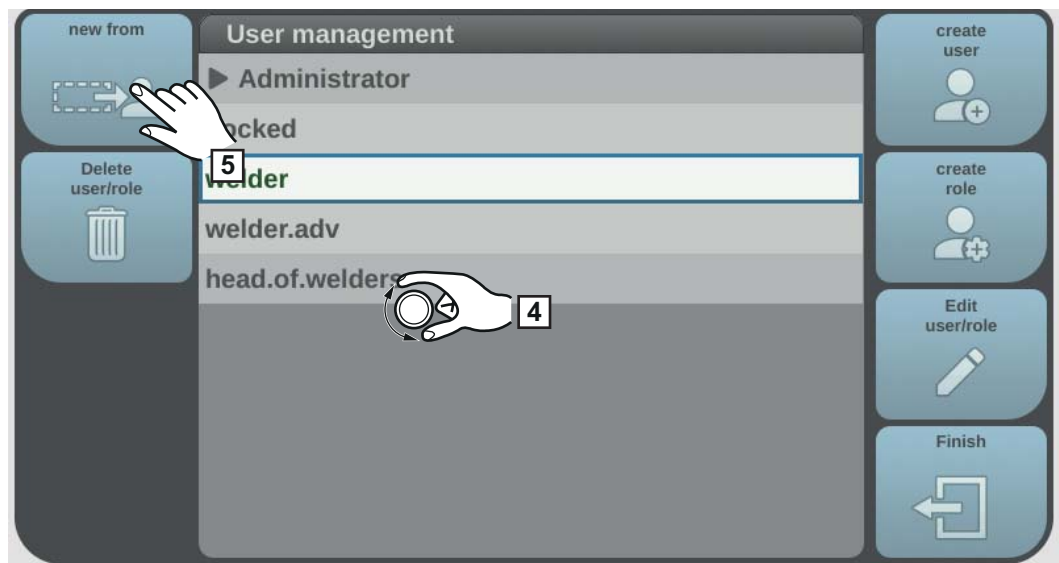

- 4 Turn the adjusting dial and select the role to be copied
- 5 Select "new from"
- 6 Enter a name for the new role using the keyboard
- 7 Select "OK"
- 8 Specify executable functions for the role
 - Select function by turning the adjusting dial
 - Press the adjusting dial
 - Select the settings for the functions from the list
- 9 Select "OK"

Creating a user

Creating a user

NOTE!

For privacy reasons, only person identity numbers and not full names should be entered when creating users.

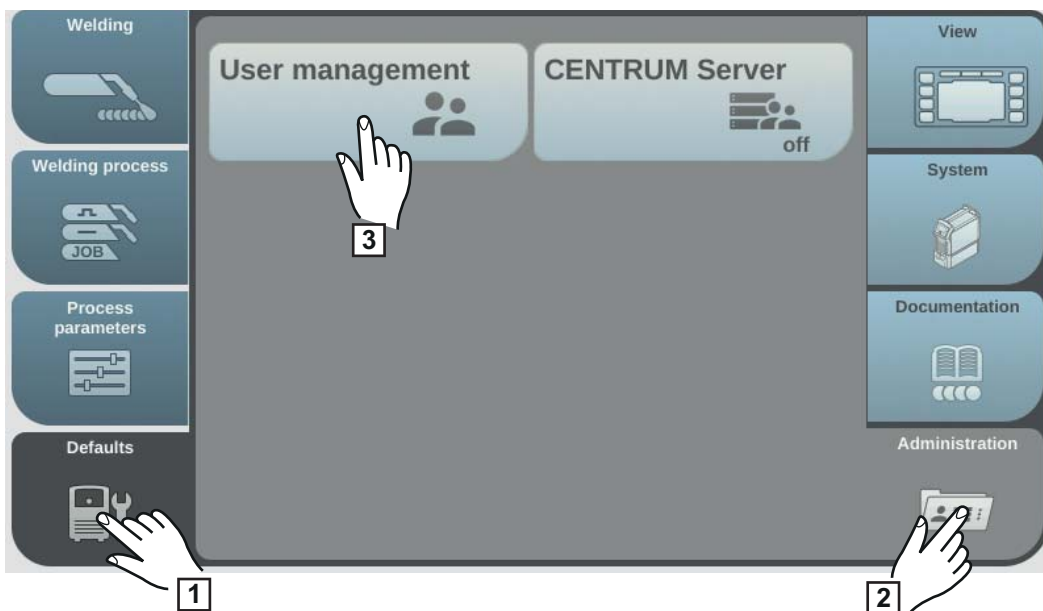

- 1 Select "Defaults"
- 2 Select "Administration"
- 3 Select "User management"

User management appears.

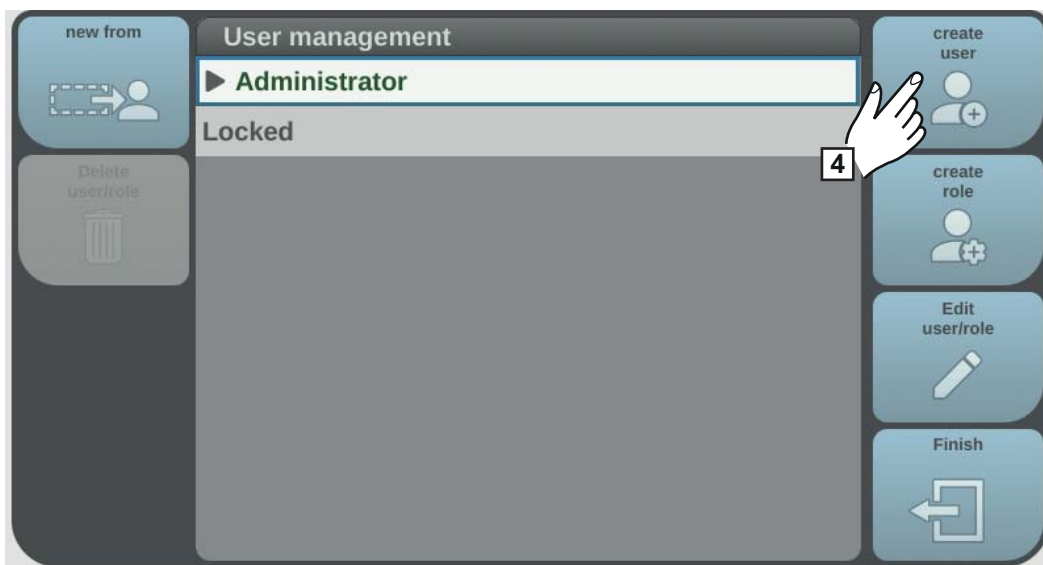

- 4 Select "create user"

The keyboard is displayed.

- 5 Use the keyboard to enter the desired user name (max. 20 characters)
- 6 Select "OK" to confirm the user name / press the adjusting dial
- 7 Enter further user data
 - Select parameters by turning the adjusting dial
 - Press the adjusting dial
 - Select role, language, unit and standard (norm) from the list
 - Enter first name, last name and web password by using the keyboard
- 8 Turn the adjusting dial and select "NFC card"
- 9 Press the adjusting dial

The information to be transferred to the NFC card is displayed.

- 10 Follow the instructions displayed
(hold the new NFC key on the NFC key reader and wait for confirmation of identification)

Copying users

NOTE!

For privacy reasons, only person identity numbers and not full names should be entered when creating users.

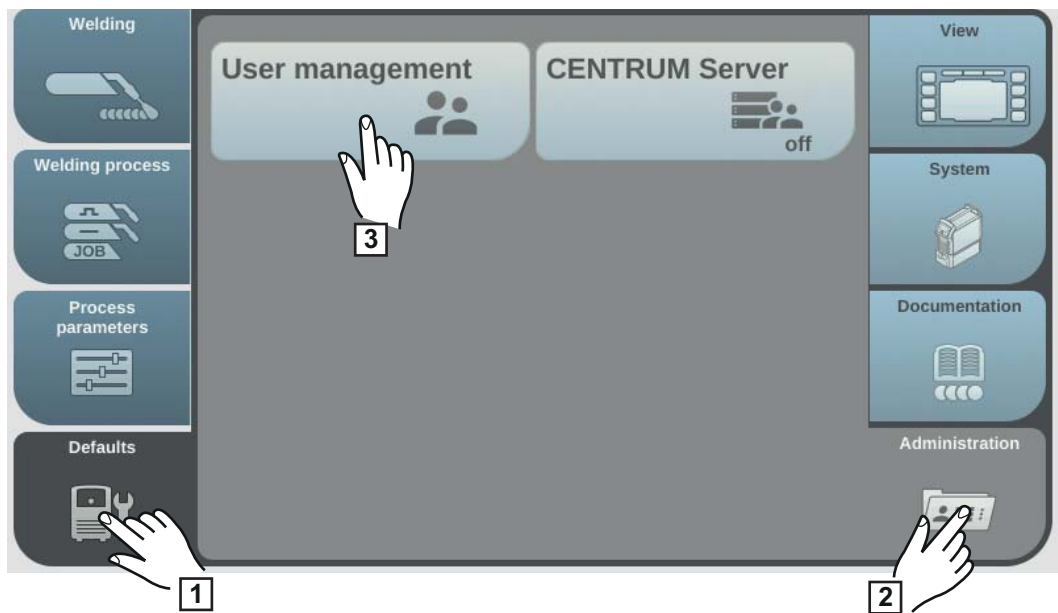

- 1 Select "Defaults"
- 2 Select "Administration"
- 3 Select "User management"

User management appears.

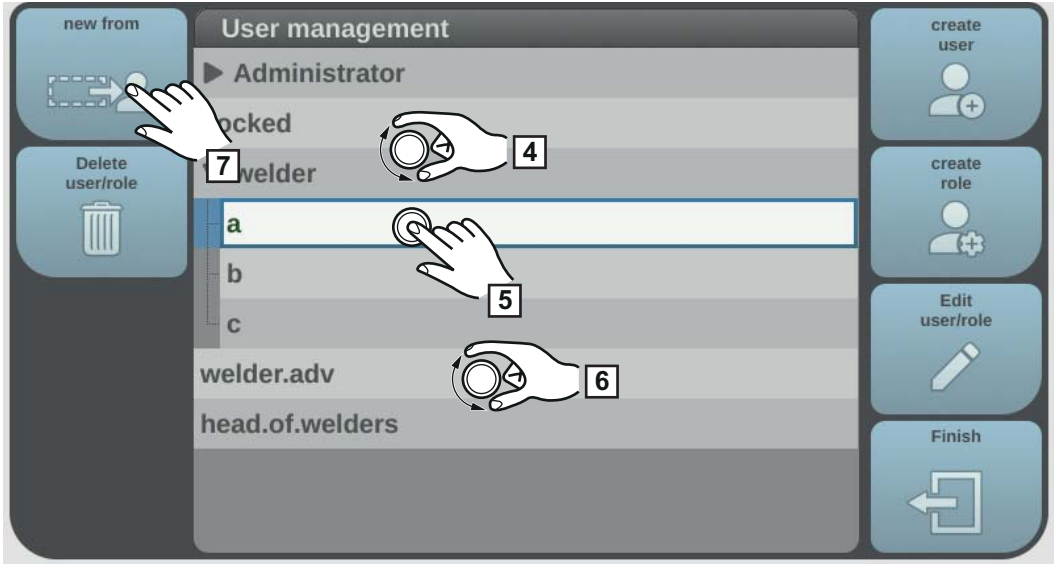

- 4 Turn the adjusting dial and select the role to which the user to be copied is assigned
- 5 Press the adjusting dial
- 6 Turn the adjusting dial and select the user to be copied
- 7 Select "new from"
- 8 Enter a name for the new user using the keyboard
- 9 Select "OK"
- 10 Specify further user data
- 11 Assign new NFC key
- 12 Select "OK"

Editing roles / users, deactivating user management

Editing roles

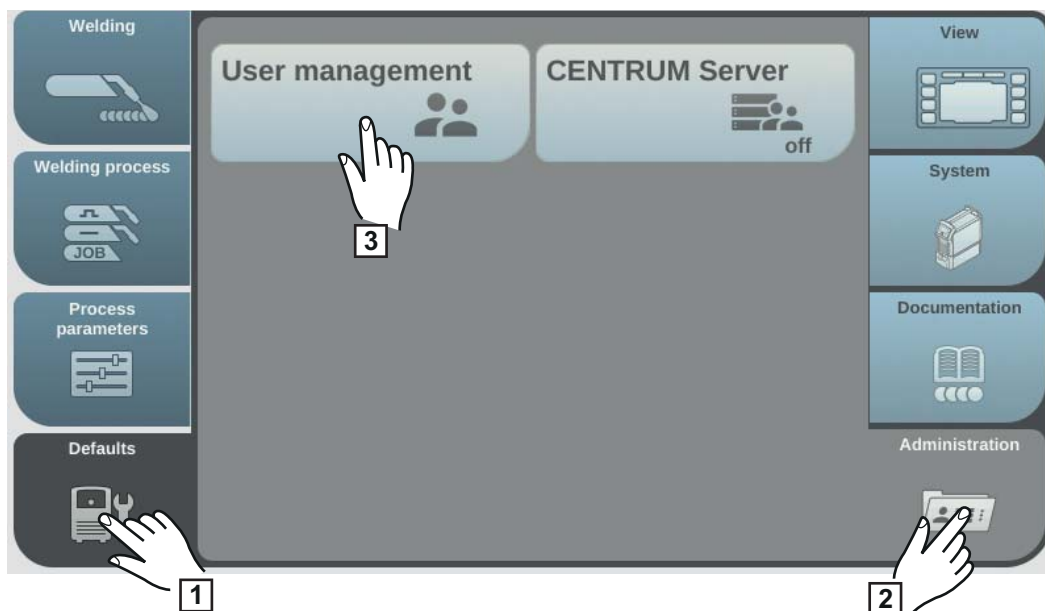

- 1 Select "Defaults"
- 2 Select "Administration"
- 3 Select "User management"

User management appears.



- 4 Turn the adjusting dial and select the desired role
- 5 Select "Edit user/role"

The role will open, the functions can be adjusted:

- Select function by turning the adjusting dial
- Press the adjusting dial
- Change the role name using the keyboard
- Select the settings for the functions from the list

6 Select "OK"

If no user is assigned to a role, then it is possible to start editing the role by pressing the adjusting dial.

Deleting roles

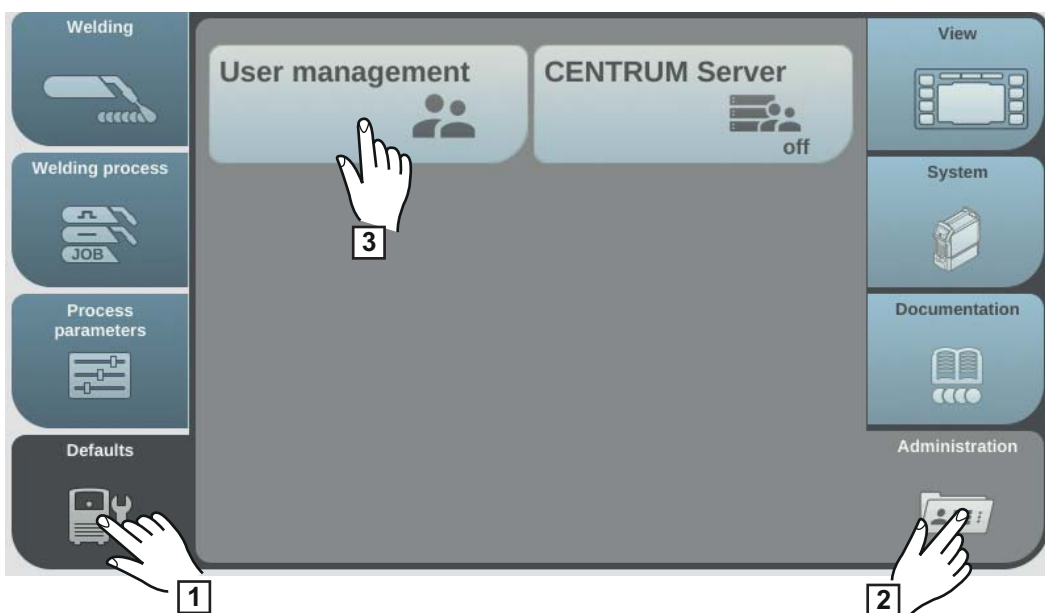

- 1 Select "Defaults"
- 2 Select "Administration"
- 3 Select "User management"

User management appears.

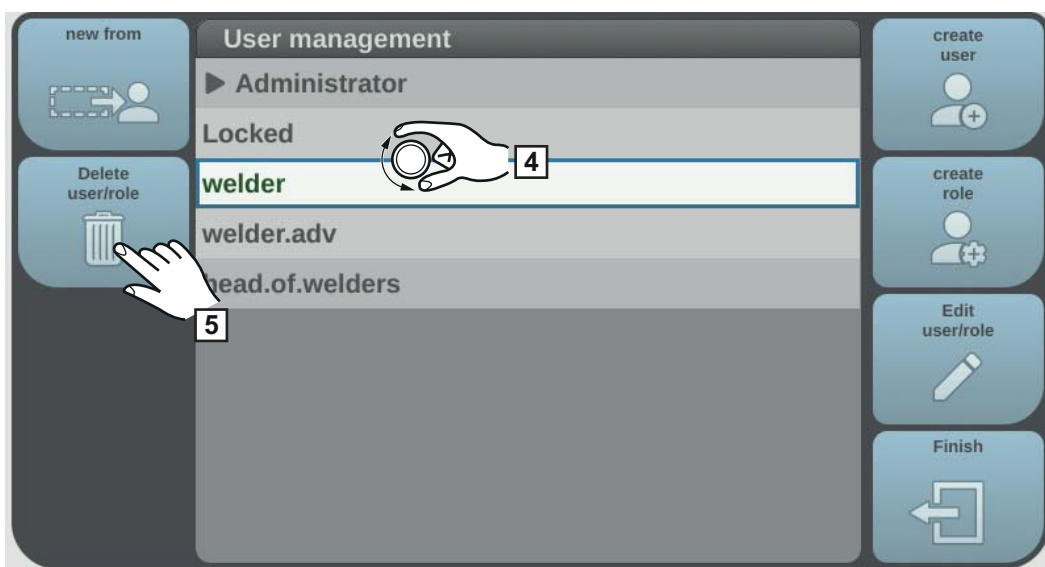

- 4 Turn the adjusting dial and select the role to be deleted
- 5 Select "Delete user/role"
- 6 Confirm when prompted

The role and all assigned users will be deleted.

Editing users

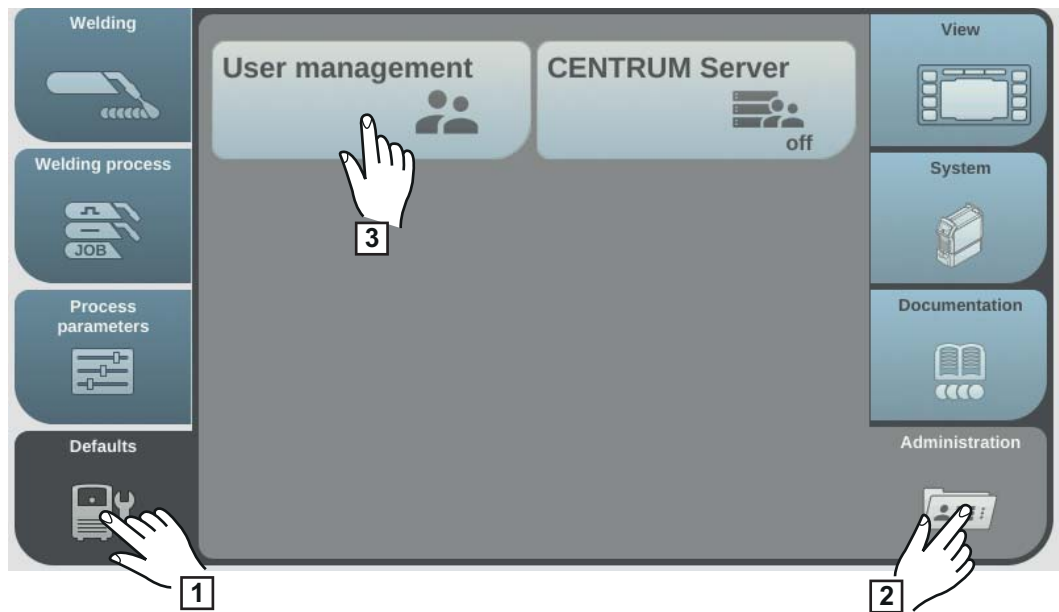

- 1 Select "Defaults"
- 2 Select "Administration"
- 3 Select "User management"

User management appears.

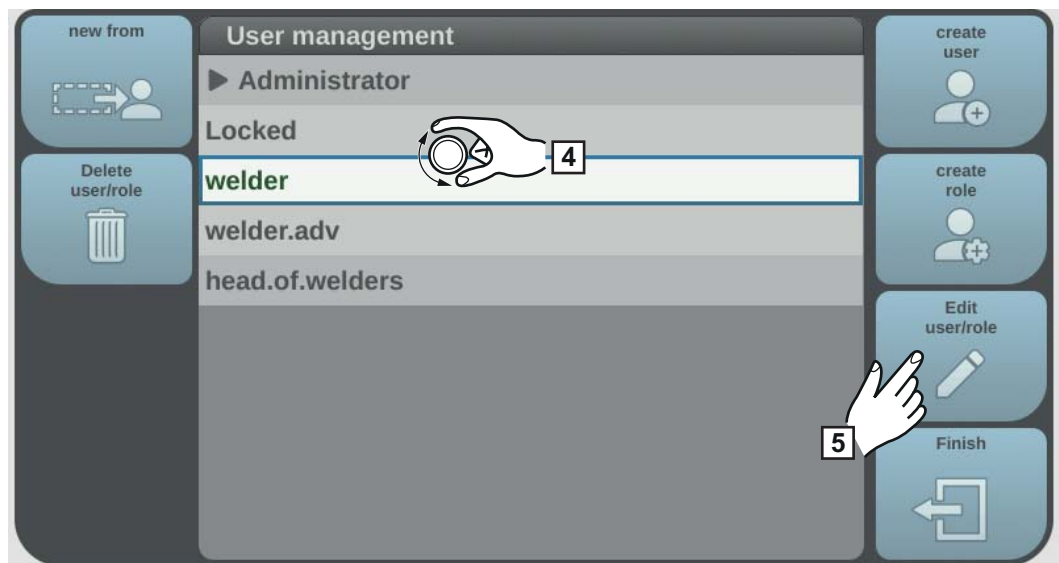

- 4 Turn the adjusting dial and select the role to which the user to be edited is assigned
- 5 Press the adjusting dial

The users assigned to the role are displayed.

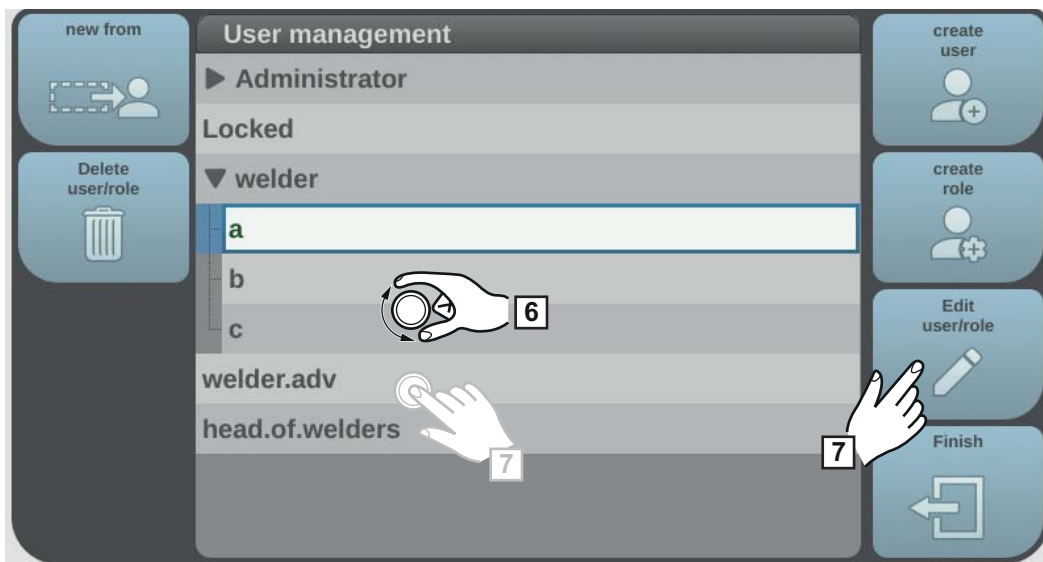

- 6 Turn the adjusting dial and select the user to be edited
- 7 Select "Edit user/role" (or press the adjusting dial)
 - Select parameters by turning the adjusting dial
 - Press the adjusting dial
 - Change the name and web password using the keyboard
 - Select other settings from the list

Replace NFC card:

- Turn the adjusting dial and select "NFC card"
- Press the adjusting dial
- Select "replace"
- Hold the new NFC key on the NFC key reader and wait for confirmation of identification
- Select OK

- 8 Select "OK"

Deleting users

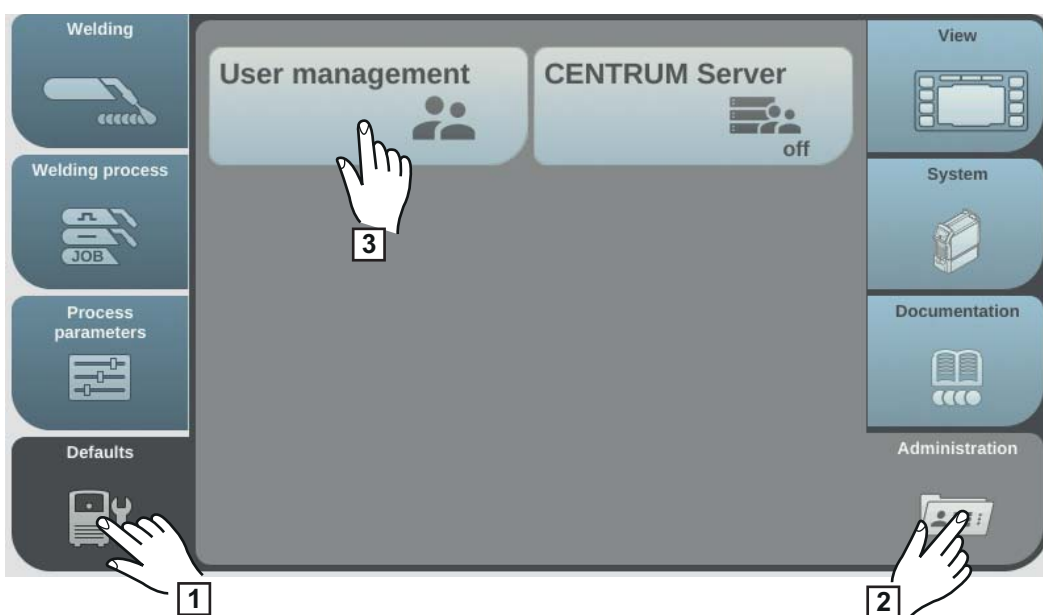

- 1 Select "Defaults"

- 2 Select "Administration"
- 3 Select "User management"

User management appears.

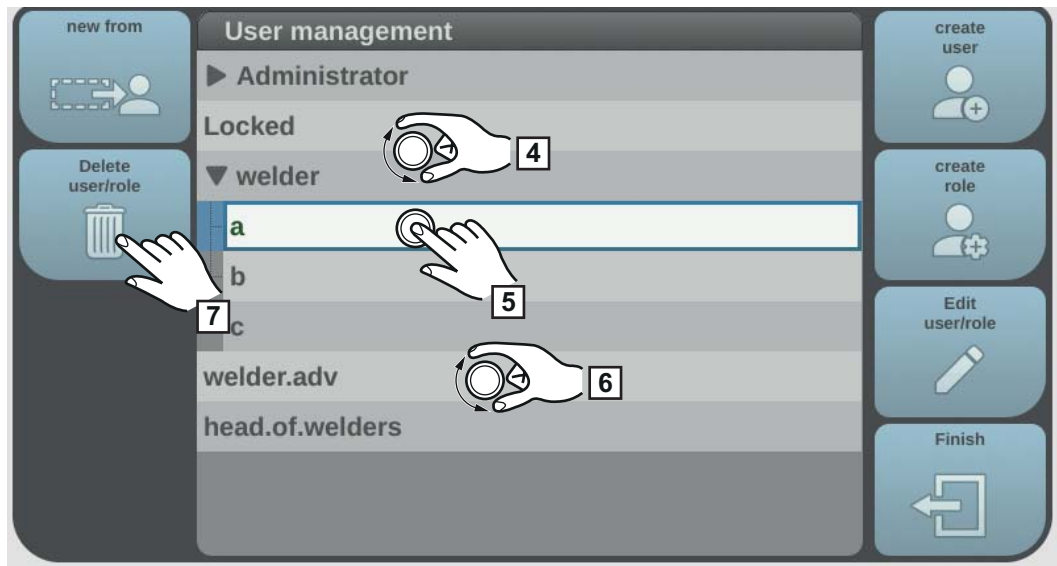

- 4 Turn the adjusting dial and select the role to which the user to be deleted is assigned
- 5 Press the adjusting dial
- 6 Turn the adjusting dial and select the user to be deleted
- 7 Select "Delete user/role"
- 8 Confirm when prompted

The user is deleted.

Deactivating user management

- 1 Select the pre-defined "admin" user under Defaults / Administration / User management
- 2 Turn the adjusting dial and select "NFC card"

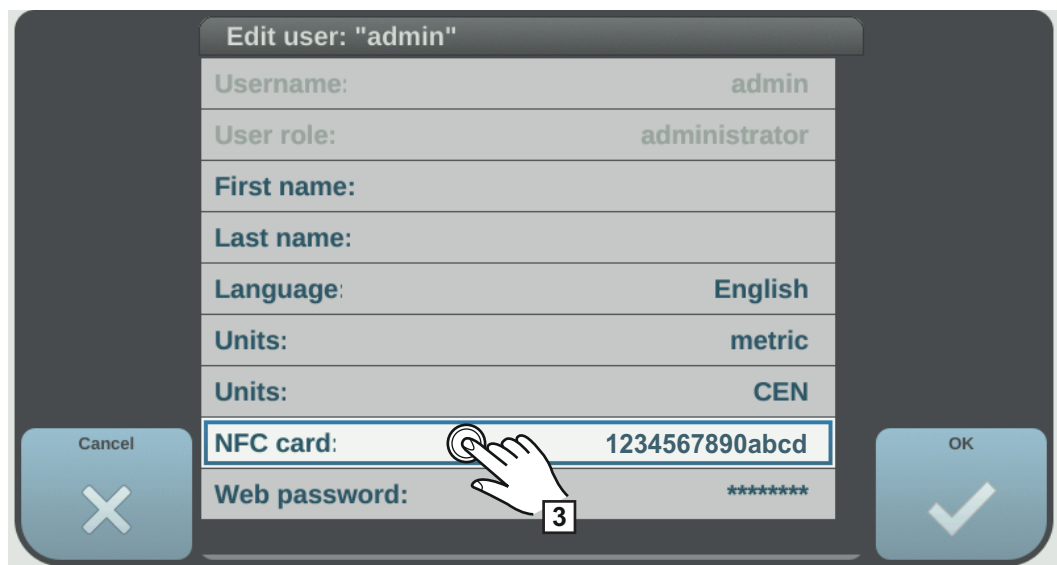

- 3 Press the adjusting dial

A confirmation prompt asking whether you want to delete or replace the NFC card is displayed.

NOTE!

If the NFC card is deleted by the predefined "admin" user, user management is deactivated.

- 4 Select "delete"

User management is deactivated, the power source is locked.

The power source can be locked and unlocked again with any NFC key (also see page 70).

Lost NFC administrator key?

Procedure when

- user management is active,
- the power source is locked and
- the NFC administrator key has been lost:

- 1 Touch the key symbol in the status bar on the display

Information on the loss of the administrator card is displayed.

- 2 Note the IP address of the power source
- 3 Open the power source SmartManager (enter the IP address of the power source in a browser)
- 4 Contact Fronius After-Sales Service

CENTRUM - Central User Management

Activating the CENTRUM server

CENTRUM is a piece of software for the central management of users. Detailed information is available in the CENTRUM Operating Instructions (42,0426,0338,xx).

The CENTRUM server can also be activated using the power source, as follows:

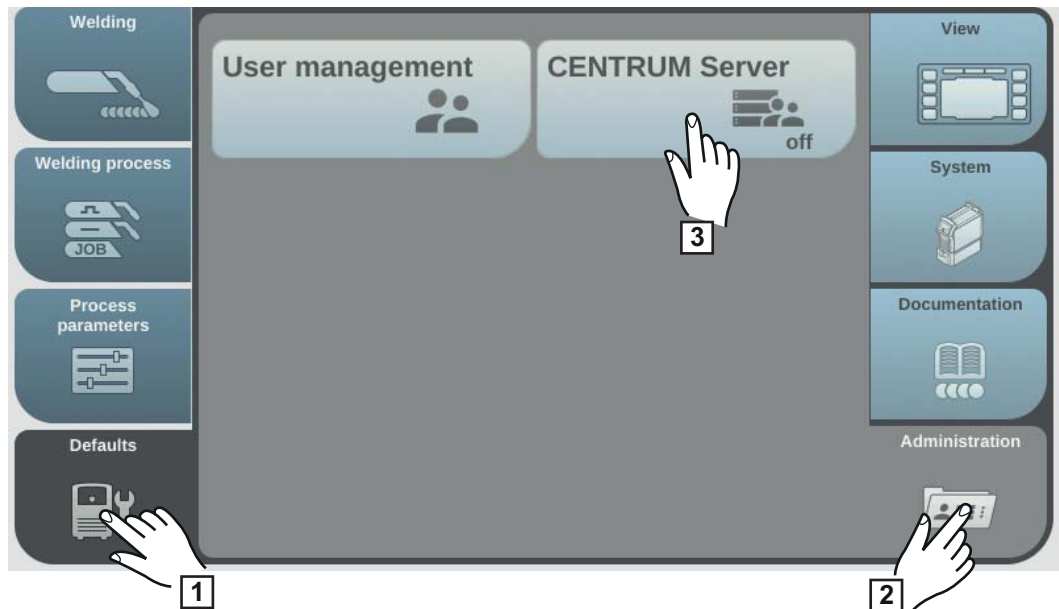

- 1 Select "Defaults"
- 2 Select "Administration"
- 3 Select "CENTRUM Server"

The Central User Management Server is displayed.

- 4 Activate the CENTRUM server (press the adjusting dial)
- 5 Select CENTRUM server, press the adjusting dial and use the keyboard to enter the address of the CENTRUM server
- 6 Select the verify CENTRUM button
- 7 Save

SmartManager - The power source website

SmartManager - The power source website

General remarks

The power source has its own website: SmartManager.

As soon as the power source is connected to a computer with the help of a network cable, or is integrated into a network, the power source's SmartManager can be retrieved using the power source's IP address.

At least IE 10 or a similar modern browser is required to access SmartManager.

The entries displayed on SmartManager may vary depending on system configuration, software upgrades and available options.

Examples of entries displayed:

- Actual system data
- Documentation
- Job data
- Power source configuration
- Backup & Restore
- User management
- Signal visualisation
- Overview
- Update
- Function packages
- Characteristics overview
- Screenshot
- Robot interface *

* Depending on the available robot interface, the name of the interface will be displayed as an entry on the website.

Opening and logging into the power source SmartManager

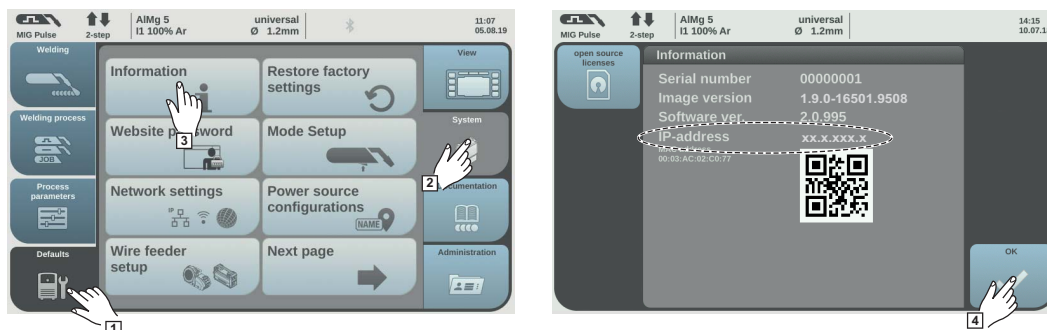

1 Settings / System / Information ==> Note down the IP address for the power source

2 Enter the IP address in the browser search field

3 Enter user name and password

Factory setting:
User name = admin
Password = admin

4 Confirm the displayed message

The power source SmartManager is displayed.

**Help function,
should you be
unable to log in**

There are two auxiliary functions when logging on to SmartManager:

- Start unlocking function?
- Forgotten password?

Start unlocking function?

An unintentionally locked power source can be unlocked with this function and all its functions made available.

- 1 Click "Start unlocking function"?
- 2 Create verification file:
click on "Save"

A TXT file with the following name will be saved to the computer's "Downloads" folder:

unlock_SN[serial number]_YYYY_MM_DD_hhmmss.txt

- 3 Send this verification file to Fronius Technical Support by e-mail:
welding.techsupport@fronius.com

Fronius will respond to each e-mail with a one-time unlocking file named as follows:

response_SN[serial number]_YYYY_MM_DD_hhmmss.txt

- 4 Save the unlocking file to your computer
- 5 Click on "Search unlocking file"
- 6 Apply unlocking file
- 7 Click on "Install unlocking file"

This will work just once to unlock the power source.

Forgotten password?

After clicking "Forgotten password?" a notice will be displayed explaining that the password can be reset on the power source (see "Resetting the website password", page [164](#)).

Changing password / logging off

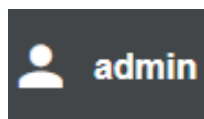

By clicking this symbol

- the user password can be changed
- you can log out of SmartManager

Changing the password for the SmartManager:

- 1 Enter the old password
- 2 Enter the new password
- 3 Repeat the new password
- 4 Click on "Save"

Settings



Clicking on this symbol expands the display of characteristics, material specifications and certain welding parameters for the power source's SmartManager.

The settings depend on which user is currently logged on.

Language selection



The languages available for SmartManager can be displayed by clicking on the language abbreviation.

Bahasa Indonesia	Čeština	Dansk
Deutsch	Eesti	English
Español	Français	Hrvatski
Íslenska	Italiano	Latviešu
Lietuviškas	Magyar	Nederlands
Norsk	Polski	Português
Română	Slovenščina	Slovenský
srpski	Suomi	Svenska
tiếng Việt	Türkçe	Русский
Українська	हिन्दी	தமிழ்
ไทย	한국어	中文
日本語		

The language that is currently set is highlighted in white.

To change the language, click on the one you would like.

Status indicator

The current status of the power source is shown between the Fronius logo and displayed power source.



Attention / Warning



Fault on the power source *



Power source is welding



The power source is ready (online)



The power source is not ready (offline)

* In the event of an error, a red error line complete with error number will be displayed above the line with the Fronius logo.
Clicking on the error line will reveal a description of the error.

Fronius

A click on the Fronius logo opens the homepage of Fronius: www.fronius.com.

Current system data

Current system data

The welding system's current data is displayed, e.g.:

Machine name	Production building (hall)	Cell
Installation location		Additional information

Welding process

ACT		
Welding current	Welding voltage	Wire speed
Arc length correction	Pulse/dynamic correction	Current arc power
Arc length stabilizer	Penetration stabilizer	Current arc energy
Motor current 1	Motor current 2	
Coolant circulation	Shielding gas flow rate*	Total shielding gas consumption*
Coolant temperature	Arc time	Total operating hours

Operating mode | Filler metal & shielding gas | Characteristic & diameter | ID | Stabilizers, CMT Cycle Step

* only with OPT/i gas controller option present

Set values are displayed, as well as actual values and hold values for the welding current, welding voltage and wire speed. Miscellaneous other actual values are displayed as well as general system data.

Documentation, logbook

Documentation

The last 100 logbook entries are shown in the Documentation entry. These logbook entries can be welding operations, errors, warnings, notifications and events. Press the "Time filter" button to restrict the data to a specific period of time. To do so, the date (yyyy mm dd) and time (hh mm) are entered in the format from – to in each case. A blank filter loads the latest welding operations again. The option to show welding operations and events can be disabled.

The following data is displayed:



- (1) Welding operation number
- (2) Start time (date and time)
- (3) Welding duration in s
- (4) Welding current in A (average value)
- (5) Welding voltage in V (average value)
- (6) Wire speed in m/min
- (7) IP - arc power in W (from real-time values in accordance with ISO/TR 18491)
- (8) IE - arc energy in kJ (in total across the entire weld in accordance with ISO/TR 18491)

Robot speed and jobs are also displayed if present in the system.

Clicking on a logbook entry will display details.

Details for welds:

Section no.



- (9) Duration of the welding section in s
- (10) Welding current in A (average value)
- (11) Welding voltage in V (average value)
- (12) Wire speed in m/min
- (13) Welding speed (cm/min)
- (14) Arc power from real-time values in W (for details see page [159](#))
- (15) Arc energy in kJ (for details see page [160](#))
- (16) Job no.
- (17) Process



Further values can be displayed by clicking on the "Insert column" button:

- I max / I min: maximum/minimum welding current in A
- Max power / Min power: maximum/minimum arc power in W
- Start time (power source time); date and time
- U max / U min: maximum/minimum welding voltage in V
- Vd max / Vd min: maximum/minimum wire speed in m/min

If the OPT/i documentation option is available on the power source, individual welding sections can also be displayed.



This documentation can be exported in the desired format using the "PDF" and "CSV" buttons.

In order to create CSV exports, the OPT/i documentation option must be available on the power source.

Job-Data

Job data

If the OPT/i Jobs option is available on the power source, the following is possible in the Job data entry:

- Existing welding system jobs can be viewed *
- Existing welding system jobs can be optimised
- Jobs stored externally can be transferred to the welding system
- Existing jobs in the welding system can be exported as a PDF * or CSV file

* Viewing and exporting as PDF also works when the OPT/i limit monitoring option is not available on the power source.

Job overview

The job overview lists all jobs stored in the welding system. Clicking on a job displays the data and parameters stored for this job. Job data and parameters can only be viewed in the job overview. The column width for parameters and values can be easily dragged and adjusted with the mouse pointer. Other jobs can easily be added to the list with the data listed by clicking on the "Add job" button.



All added jobs are compared to the job that is currently selected.

Editing a job

Existing welding system jobs can be optimised, provided the OPT/i Jobs option is present on the power source.

- 1 Click on "Edit job"
- 2 Click on the job to be amended in the list of available jobs

The selected job is opened and the following job data is shown:

- **Parameter**
The parameter currently stored in the job
- **Value**
The values of the parameter currently stored in the job
- **Change value to**
To enter the new parameter value
- **Setting range**
Possible setting range for the new parameter values

- 3 Amend the values accordingly
- 4 Save / Delete adjustments, Save as / Delete job



As an aid when editing a job, other jobs can be added with ease to the list with the data displayed by clicking on "Add job".



Creating a new job

- 1 Click on "Create new job"



- 2 Enter job data
- 3 Click on "OK" to apply the new job

Importing a job

This function allows jobs stored externally to be transferred to the welding system, provided the OPT/i Jobs option is available on the power source.

- 1 Click on "Search Job-file"
- 2 Select desired job file

Individual jobs can be selected and new job numbers assigned in the preview of the job import list.

- 3 Click on "Import Job"

If the import is successful, a corresponding confirmation is displayed and the imported jobs appear in the list.

Exporting a job

This function allows jobs from the power source to be stored externally, provided the OPT/i Jobs option is available on the power source.

- 1 Select jobs to be exported
- 2 Click on "Export Job"

The jobs are exported as an XML file into the computer's Download folder.

Exporting job(s) as...

Under "Job overview" and "Edit job", existing jobs in the welding system can be exported as PDF or CSV files.

For CSV exports, the jobs OPT/i jobs option must be present on the power source.

- 1 Click on "Export job(s) as..."



The PDF or CSV settings are displayed.

- 2 Select the job(s) to be exported:
current job / all jobs / job numbers
- 3 Click on "Save PDF" or "Save CSV"

A PDF or CSV file containing the selected jobs is created and saved according to the settings of the browser in question.

Power source settings

Process parameters General process parameters and process parameters for power source components and monitoring can be viewed and changed under process parameters.

Changing process parameters

- 1 Click parameter group / welding parameter
 - 2 Alter the parameter value directly in the display field
 - 3 Save changes
-

Name & location The power source configuration can be viewed and changed under name & location.

MQTT settings Only displayed if the OPT/i MQTT option is installed on the power source.

MQTT - Message Queuing Telemetry Transport
(standardised data interface protocol)

Supported functions:

- Provides the real-time data to be transferred to other systems
- Fixed amount of data
- Reads

Defining MQTT settings

- 1 Activate MQTT
 - 2 Enter broker, port and device topic
 - 3 Select safety certificate
 - 4 Enter authentication
 - 5 Save changes
-

OPC UA settings Only displayed if the OPT/i OPC UA option is installed on the power source.

OPC-UA - Open Platform Communications - Unified Architecture
(standardised data interface protocol)

Supported functions:

- Provides the real-time data to be transferred to other systems
- Possible to copy data from other systems
- Fixed amount of data
- Reads & writes

Defining OPC UA settings

- 1 Activate OPC UA server
- 2 Select safety directive
- 3 Enter authentication
- 4 Save changes

Backup & Restore

- General remarks** In the backup & restore entry
- all welding system data can be saved as a backup (e.g. current parameter settings, jobs, user characteristics, defaults, etc.),
 - any backups will be restored to the welding system
 - You can select which data you would like to be backed up automatically.
-

Backup & Restore

Starting backup

- 1 Click on "Start backup" to save a backup of the welding system data

The data is saved in a selected location in the default format MCU1-YYYYMMDDH-
Hmm.fbc.

YYYY = Year
MM = Month
DD = Day
HH = Hour
mm = Minute

The date and time correspond to the power source settings.

Searching for a restore file

- 1 Click on "Search restore file" to transfer an available backup to the power source
- 2 Select the file and click on "Open"

The selected backup file is displayed on the power source SmartManager under "Restore".

- 3 Click on "Start recovery"

Once the data has been successfully restored, a confirmation to this effect is displayed.

Automatic backup

- 1 Enable interval settings
- 2 Enter the intervals at which the automatic backup should take place:
 - **Interval:**
daily / weekly / monthly
 - **At:**
time (hh:mm)
- 3 Enter the data for the backup destination:
 - **Protocol:**
SFTP (Secure File Transfer Protocol) / SMB (Server Message Block)
 - **Server:**
Enter IP address of the destination server
 - **Port:**
Enter port number; if no port number is entered, the default port 22 is automatically used.
If SMB is set under Protocol, leave the Port field blank.
 - **Storage location:**
This configures the subfolder where the backup will be stored.
If no storage location is entered, the backup is stored in the root directory of the server.

IMPORTANT! For SMB and SFTB, always enter the storage location with a slash "/".
 - **Domain/user, password:**
User name and password - as configured on the server;
When entering a domain, first enter the domain, then backslash "\" and then the user name (DOMAIN\USER)
- 4 If a connection via proxy server is required, activate and enter the proxy settings:
 - Server
 - Port
 - Users
 - Password
- 5 Save changes
- 6 Trigger automatic backup

If you have any questions about the configuration, contact your network administrator.

Signal visualisation

Signal visualisation

Signal visualisation is only available if a robot interface is present.
To display the signal visualisation correctly, IE 10 or another modern browser is required.

The signals and commands transferred via a robot interface are displayed.

IN ... Signals from the robot control to the power source

OUT ... Signals from the power source to the robot control

You can search for, sort and filter the displayed signals at any time.

To sort the characteristics in ascending or descending order, click on the arrow next to the respective information. The column widths can be easily dragged and adjusted with the cursor.

The following information is required for a detailed description of the signals:

- Bit position
- Signal name
- Value
- Data type

User management

General

In the user management entry

- users can be viewed, changed and created.
- user roles can be viewed, changed and created.
- users and user roles can be exported or imported on the power source.
User management data present on the power source is overwritten by importing.
- a CENTRUM server can be activated.

User management is created on a power source and can then be saved with the export/import function and transferred to another power source.

Users

Existing users can be viewed, changed and deleted; new users can be created.

Viewing/changing a user:

- 1 Select user
- 2 Alter the user data directly in the display field
- 3 Save changes

Deleting a user:

- 1 Select user
- 2 Click the "Delete user" button
- 3 When prompted, confirm with OK

Creating a user:

- 1 Click the "Create new user" button
 - 2 Enter user data
 - 3 Confirm with OK
-

User roles

Existing user roles can be viewed, changed and deleted, new user roles can be created

Viewing/changing a user role:

- 1 Select user role
- 2 Alter the user role directly in the display field
- 3 Save changes

The "Administrator" role cannot be changed.

Deleting a user role:

- 1 Select user role
- 2 Click the "Delete user role" button
- 3 When prompted, confirm with OK

The "Administrator" and "Locked" roles cannot be deleted.

Creating a user role:

- 1 Click the "Create new user role" button
 - 2 Enter a role name, apply values
 - 3 Confirm with OK
-

Export & import

Exporting users and user roles from a power source

- 1 Click on "Export"

The user management data from the power source will be saved to the "Downloads" folder on the computer.

File format: userbackup_SNxxxxxxx_YYYY_MM_DD_hhmmss.user

SN = Serial number, YYYY = Year, MM = Month, DD = Day
hh = hour, mm = minute, ss = second

Importing users and user roles to a power source

- 1 Click on "Search user data file"
- 2 Select the file and click "Open"
- 3 Click on "Import"

The user management data will be saved to the power source.

CENTRUM

For activating a CENTRUM server
(CENTRUM = Central User Management)

- 1 Activate CENTRUM server
- 2 In the input field, enter the domain name or IP address of the server where Central User Management has been installed.

A valid DNS server must be configured in the power source network settings if using a domain name.

- 3 Click the "Verify server" button

This checks the availability of the specified server.

- 4 Save changes

Overview

Overview

In the overview entry, welding system components and options are displayed with all available information, e.g. firmware version, item number, serial number, production date, etc.

Expand all groups / Reduce all groups

Click the "Expand all groups" button to show more details of the individual system components.

Power source example:

- TPSi Touch: item number
MCU1: item number, version, serial number, production date
Bootloader: version
image: Version
licences: WP Standard, WP Pulse, WP LSC, WP PMC, OPT/i Guntrigger, etc.
- SC2: item number
firmware: version

Click the "Reduce all groups" button to hide the system component details again.

Save as XML-file

Click the "Save as XML-file" button to create an XML file of the system component details. This XML file can either be opened or saved.

Update

Update

The power source firmware can be updated in the "Update" entry.

The current firmware version on your power source is displayed.

Updating the power source firmware:



The update file can be downloaded via the following link, for example:

<http://tps-i.com/index.php/firmware>

- 1 Organise and save the update file
- 2 Click on "Search update file" to start the update process
- 3 Select update file

Click on "Update"

Once the update has been successfully completed, the power source may need to be restarted.

When an update has been completed successfully, a confirmation to this effect is displayed.

Searching for an update file (performing the update)

- 1 After clicking on "Search update file", select the desired firmware (*.ffw)
- 2 Click on "Open"

The selected update file is displayed on the power source SmartManager under "Update".

- 3 Click on "Update"

A progress bar is displayed above the update process.

When this reaches 100%, you will be prompted to restart the power source.



SmartManager is not available during the restart.

After the restart, SmartManager may not be available anymore.

If you select "No", the new software functions are activated when you next switch the device on/off.

- 4 To restart the power source, click on "Yes"

The power source restarts; the display goes black for a short time.
The Fronius logo is shown on the power source display during the restart.

Once the update has been completed successfully, confirmation and the current firm-ware version are displayed.
Finally, log back on to SmartManager.

Fronius Weld-Connect

The mobile application Fronius WeldConnect can also be called up in the "Update" entry. Fronius WeldConnect helps welders, design engineers and work schedulers to estimate various welding parameters.



Fronius WeldConnect

Fronius WeldConnect is available in the following forms:

- WeldConnect online (direct link)
- As an Android app
- As an Apple/iOS app

The welding parameters established in the mobile app can be transferred as welding jobs to the power source via WLAN (you will need to enter the IP address).

Function Packages

Function Packages

In the Function Packages entry, the function packages, special characteristics, options, etc., present on the power source are displayed.
New function packages can also be uploaded.

Welding Packages

Under Welding Packages, the welding packages present on the power source are displayed with their respective item numbers, e.g.:

- WP Standard, (MIG/MAG standard synergic welding)
- WP Pulse (MIG/MAG pulse synergic welding)
- WP LSC (Low Spatter Control, low-spatter dip transfer arc process)
- WP PMC (Pulse Multi Control, enhanced pulsed arc welding process)

Possible upgrades:

- WP CMT
 - etc.
-

Special characteristics

Under special characteristics, the available special characteristics present on the power source are displayed with their respective item numbers, e.g.:

- PMC - AlMg4,5Mn(Zr) - I3 Ar...
 - etc.
-

Options

The options available on the power source are displayed under "Options" with their respective item numbers and possible upgrades, e.g.:

Options

- OPT/i GUN Trigger
- etc.

Possible upgrades

- OPT/i Jobs
 - OPT/i Interface Designer ...
 - etc.
-

Installing a function package

- 1 Organise and save a function package
- 2 Click on "Search function package file"
- 3 Select the desired function package file (*.xml)
- 4 Click on "Open"

The selected function package file is displayed on the power source SmartManager under "Install function package".

- 5 Click on "Install function package"

Once the function package has been successfully installed, a confirmation to this effect is displayed.

Synergic lines overview

Characteristics overview

In the Characteristics overview entry:

- Available characteristics in the welding system can be displayed: (Available characteristics button).
- Possible characteristics in the welding system can be displayed: (Possible characteristics button).

You can search for, sort and filter the displayed characteristics at any time.

The following information is displayed for the characteristics:

- | | |
|------------|--------------------------|
| - Status | - Replaced by |
| - Material | - SFI |
| - Diameter | - SFI HotStart |
| - Gas | - Penetration stabilizer |
| - Property | - Arc length stabilizer |
| - Process | - CMT Cycle Step |
| - ID | - Special |

To sort the characteristics in ascending or descending order, click on the arrow next to the respective information.

The column widths can be easily dragged and adjusted with the cursor.

Showing/hiding the filter

Show filter



Hide filter



Clicking on the "Show filter" symbol displays the possible filter criteria. With the exception of "ID" and "Replaced by", the characteristics can be filtered by all information.

First selection box = select all

To hide the filter criteria, click on the "Hide filter" symbol.

Screenshot

Screenshot

In the Screenshot entry, a digital image of the power source display can be created at any time, irrespective of the navigation or set values.

1 Click on "Create screenshot" to capture a screenshot of the display

A screenshot of the currently displayed settings is created.

Different functions are available for saving the screenshot depending on the browser used; the display may vary.

Interface

If a robot interface is available, the name of the interface will be displayed as an entry on the power source website.

The following welding parameters can be displayed, edited, saved or deleted:

- Characteristic assignment (current allocation of program numbers to characteristics)
- Module configuration (network settings)

Factory settings can be restored and the module can be restarted.

Troubleshooting and maintenance

Troubleshooting

General

The power sources are equipped with an intelligent safety system, meaning it has been possible to dispense with nearly all fuses. After a possible malfunction has been remedied, the power source can be used again as normal.

Possible malfunctions, warning notices or status codes are shown on the display as plain text dialogues.

Safety



WARNING!

An electric shock can be fatal.

Before opening the device

- ▶ Turn the mains switch to the "O" position
- ▶ Unplug the device from the mains
- ▶ Ensure the device cannot be switched back on
- ▶ Using a suitable measuring instrument, check to make sure that electrically charged components (e.g. capacitors) have been discharged



WARNING!

Danger from inadequate ground conductor connection.

Possible serious injury and damage to property.

- ▶ The housing screws provide a suitable ground conductor connection for earthing the housing and must NOT be replaced by any other screws that do not provide a reliable ground conductor connection.

MIG/MAG welding – Current limit

“Current limit” is a safety function for MIG/MAG welding, whereby

- it is possible to operate the power source at the power limit
- process safety is ensured

If the welding power is too high, the arc gets smaller and smaller and may be extinguished. To stop the arc from being extinguished, the power source reduces the wire speed and therefore the welding power.

A corresponding message appears in the status bar on the display.

Corrective measures

- Reduce one of the following welding power parameters:
 - Wire speed
 - Welding current
 - Welding voltage
 - Material thickness
- Increase the distance between the contact tip and workpiece

**Power source -
troubleshooting**

Power source does not function

Mains switch is on, but indicators are not lit up

Cause: There is a break in the mains lead; the mains plug is not plugged in

Remedy: Check the mains lead, ensure that the mains plug is plugged in

Cause: Mains socket or mains plug faulty

Remedy: Replace faulty parts

Cause: Mains fuse protection

Remedy: Change the mains fuse protection

Cause: Short circuit on the 24 V supply of SpeedNet connection socket or external sensor

Remedy: Unplug connected components

No welding current

Mains switch is on, overtemperature is displayed

Cause: Overload; the duty cycle has been exceeded

Remedy: Check duty cycle

Cause: Thermostatic automatic circuit breaker has been tripped

Remedy: Wait until the power source automatically comes back on after the end of the cooling phase

Cause: Limited supply of cooling air

Remedy: Ensure accessibility to cooling air ducts

Cause: The fan in the power source is faulty

Remedy: Contact After-Sales Service

No welding current

Mains switch is ON and indicators are lit up

Cause: Grounding (earthing) connection is incorrect

Remedy: Check the grounding (earthing) connection for correct polarity

Cause: There is a break in the power cable in the welding torch

Remedy: Replace the welding torch

Nothing happens when the torch trigger is pressed

Mains switch is on, indicators are lit up

Cause: The control plug is not plugged in

Remedy: Plug in the control plug

Cause: Welding torch or welding torch control line is faulty

Remedy: Replace welding torch

Cause: The interconnecting hosepack is defective or not connected properly
(not for power sources with integrated wire drive)

Remedy: Check the interconnecting hosepack

No protective gas shield

All other functions are OK

Cause: Gas cylinder is empty

Remedy: Change the gas cylinder

Cause: The gas pressure regulator is faulty

Remedy: Replace the gas pressure regulator

Cause: Gas hose is not fitted or is damaged

Remedy: Fit or change the gas hose

Cause: Welding torch is faulty

Remedy: Change the welding torch

Cause: Gas solenoid valve is faulty

Remedy: Contact After-Sales Service

Poor weld properties

Cause: Incorrect welding and/or correction parameters

Remedy: Check the settings

Cause: Poor ground earth connection

Remedy: Ensure good contact to workpiece

Cause: Multiple power sources are welding one component

Remedy: Increase the distance between the hosepacks and the grounding cables;
Do not use a common earth.

Cause: Inadequate or no protective gas shield

Remedy: Check the pressure regulator, gas hose, gas solenoid valve, torch gas connection, etc.

Cause: Welding torch is leaking

Remedy: Change welding torch

Cause: Wrong contact tip, or contact tip is worn out

Remedy: Replace contact tip

Cause: Wrong wire alloy or wrong wire diameter

Remedy: Check the wire electrode that has been inserted

Cause: Wrong wire alloy or wrong wire diameter

Remedy: Check weldability of the base material

Cause: The shielding gas is not suitable for this wire alloy

Remedy: Use the correct shielding gas

Excessive welding spatter

Cause: Shielding gas, wirefeeder, welding torch or workpiece is contaminated or magnetically charged

Remedy: Perform R/L alignment;
adjust arc length;
check whether shielding gas, wirefeed, welding torch position or workpiece is contaminated or magnetically charged

Irregular wire speed

Cause: Braking force has been set too high

Remedy: Loosen the brake

Cause: Hole in the contact tip is too narrow

Remedy: Use a suitable contact tip

Cause: Faulty inner liner in welding torch

Remedy: Check the inner liner for kinks, dirt, etc. and replace if necessary

Cause: The wirefeeder rollers are not suitable for the wire electrode being used

Remedy: Use suitable feed rollers

Cause: Feed rollers have the wrong contact pressure

Remedy: Optimise the contact pressure

Wirefeed problems

when using applications with long welding torch hosepacks

Cause: Incorrect arrangement of welding torch hosepack

Remedy: Arrange the welding torch hosepack in as straight a line as possible, avoiding bends

Welding torch becomes very hot

Cause: The specification of the welding torch is inadequate

Remedy: Observe the duty cycle and loading limits

Cause: Only on water-cooled systems: Inadequate coolant flow

Remedy: Check coolant level, coolant flow, for coolant contamination, etc. For further information refer to the cooling unit operating instructions.

Care, maintenance and disposal

General Under normal operating conditions, the power source requires only a minimum of care and maintenance. However, it is vital to observe some important points to ensure the welding system remains in a usable condition for many years.

Safety

WARNING!

An electric shock can be fatal.

Before opening the device

- ▶ Turn the mains switch to the "O" position
 - ▶ Unplug the device from the mains
 - ▶ Ensure the device cannot be switched back on
 - ▶ Using a suitable measuring instrument, check to make sure that electrically charged components (e.g. capacitors) have been discharged
-

- At every start-up**
- Check mains plug, mains cable, welding torch, interconnecting hosepack and grounding (earthing) connection for damage
 - Check whether the all-round clearance of 0.5 m (1 ft. 8 in.) is kept to ensure that the cooling air can easily flow and escape.

NOTE!

Air inlets and outlets must never be covered, not even partially.

- Every 2 months**
- If present: clean air filter
-

Every 6 months

CAUTION!

Danger of damage to electronic components.

- ▶ Do not bring the air nozzle too close to electronic components.
-
- Open the device
 - Clean out the device interior using dry compressed air at reduced pressure
 - If a lot of dust has accumulated, clean the cooling air ducts
-

Updating firm- ware

IMPORTANT! To update the firmware you need a PC or laptop that is connected to the power source via an Ethernet network.

- 1** Get latest firmware (e.g. from the Fronius Download Center)
File format: official_tpsi_x.x.x-xxxx.ffw
- 2** Establish Ethernet connection between PC/laptop and power source
- 3** Open the power source SmartManager (see page [199](#))
- 4** Transfer the firmware to the power source (see page [215](#))

Disposal

Dispose of in accordance with the applicable national and local regulations.

Appendix

Average consumption values during welding

Average wire electrode consumption during MIG/MAG welding

Average wire electrode consumption at a wire speed of 5 m/min			
	1.0 mm wire electrode diameter	1.2 mm wire electrode diameter	1.6 mm wire electrode diameter
Steel wire electrode	1.8 kg/h	2.7 kg/h	4.7 kg/h
Aluminium wire electrode	0.6 kg/h	0.9 kg/h	1.6 kg/h
CrNi wire electrode	1.9 kg/h	2.8 kg/h	4.8 kg/h

Average wire electrode consumption at a wire speed of 10 m/min			
	1.0 mm wire electrode diameter	1.2 mm wire electrode diameter	1.6 mm wire electrode diameter
Steel wire electrode	3.7 kg/h	5.3 kg/h	9.5 kg/h
Aluminium wire electrode	1.3 kg/h	1.8 kg/h	3.2 kg/h
CrNi wire electrode	3.8 kg/h	5.4 kg/h	9.6 kg/h

Average shielding gas consumption during MIG/MAG welding

Wire electrode diameter	1.0 mm	1.2 mm	1.6 mm	2.0 mm	2 x 1.2 mm (TWIN)
Average consumption	10 l/min	12 l/min	16 l/min	20 l/min	24 l/min

Average shielding gas consumption during TIG welding

Gas nozzle size	4	5	6	7	8	10
Average consumption	6 l/min	8 l/min	10 l/min	12 l/min	12 l/min	15 l/min

Technical data

Explanation of the term "duty cycle"

Duty cycle (D.C.) is the proportion of time in a 10-minute cycle at which the device may be operated at its rated output without overheating.

NOTE!

The D.C. values specified on the rating plate are based on an ambient temperature of 40°C.

If the ambient temperature is higher, either the D.C. or output must be reduced accordingly.

Example: Welding at 150 A at 60% D.C.

- Welding phase = 60% of 10 minutes = 6 minutes
- Cooling phase = remaining time = 4 minutes
- After the cooling phase, the cycle begins anew.

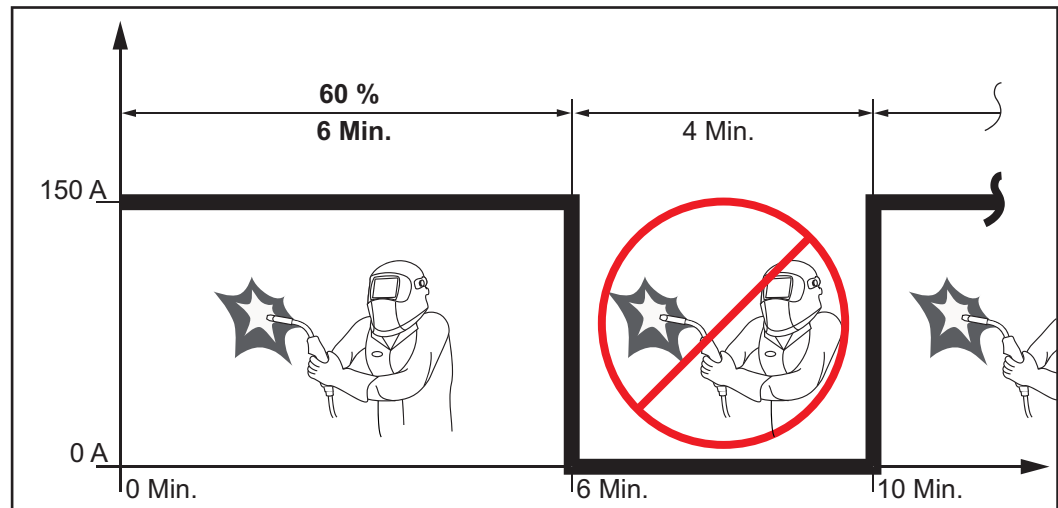

If the device is to be continuously operated without stopping:

- 1 look in the technical data for a D.C. value of 100% for the reigning ambient temperature.
- 2 Reduce the output or amperage in line with this value so that the device can remain in use without observing a cooling phase.

Special voltages

For devices designed for special voltages, the technical data on the rating plate applies.

For all machines with a permitted mains voltage of up to 460 V: The standard mains plug allows the user to operate with a mains voltage of up to 400 V. For mains voltages up to 460 V fit a mains plug permitted for such use or install the mains supply directly.

Overview with critical raw materials, year of production of the device

Overview with critical raw materials:

An overview of which critical raw materials are contained in this device can be found at the following Internet address.

www.fronius.com/en/about-fronius/sustainability.

To calculate the year of production of the device:

- Each device is provided with a serial number
- The serial number consists of 8 digits - for example 28020099
- The first two digits give the number from which the year of production of the device can be calculated
- This figure minus 11 gives the year of production
 - For example: Serial number = 28020065, calculation of the year of production = $28 - 11 = 17$, year of production = 2017

TPS 320i C

Mains voltage (U_1)	3 x 400 V
Max. effective primary current ($I_{1\text{eff}}$)	12.5 A
Max. primary current ($I_{1\text{max}}$)	19.7 A
Mains fuse protection	35 A slow-blow
Mains voltage tolerance	-15 / +15 %
Grid frequency	50/60 Hz
Cos phi (1)	0.99
Max. permitted grid impedance Z_{max} at PCC ¹⁾	96 mOhm
Recommended earth-leakage circuit breaker	Type B
Welding current range (I_2)	
MIG/MAG	3 - 320 A
TIG	3 - 320 A
Rod electrode	10 - 320 A
Welding current at 10 min/40 °C (104 °F)	40% / 320 A 60% / 260 A 100% / 220 A
Output voltage range according to standard characteristic (U_2)	
MIG/MAG	14.2 - 30.0 V
TIG	10.1 - 22.8 V
Rod electrode	20.4 - 32.8 V
Open circuit voltage (U_0 peak/ U_0 r.m.s)	71 V
Degree of protection	IP 23
Type of cooling	AF
Overvoltage category	III
Pollution degree according to IEC60664	3
EMC device class	A ²⁾
Safety symbols	S, CE
Dimensions L x W x H	706 x 300 x 510 mm 27.8 x 11.8 x 20.1 in.
Weight	35.8 kg / 78.9 lb.
Max. noise emission (LWA)	69 dB (A)
Max. shielding gas pressure	7 bar / 101 psi
Coolant	Original Fronius
Wire speed	1 - 25 m/min / 40 - 980 ipm
Wire drive	4-roller drive
Wire diameter	0.8 - 1.6 mm / 0.03 - 0.06 in.
Wirespool diameter	max. 300 mm / max. 11.8 in.

Wirespool weight	max. 19.0 kg / max. 41.9 lb.
Idle state power consumption at 400 V	34,7 W
Power source efficiency at 320 A / 32,8 V	89 %

The wirefeeder for the TPS 320i C is integrated in the power source.

- 1) Interface to a 230/400 V and 50 Hz public grid
- 2) An emission class A device is not designed for use in residential areas supplied with power from a public low-voltage grid.
The electromagnetic compatibility can be influenced by conducted or radiated radio frequencies.

TPS 320i C /nc

Mains voltage (U_1)	3 x 380 / 400 / 460 V
Max. effective primary current ($I_{1\text{eff}}$)	
3 x 380 V	12.9 A
3 x 400 V	12.5 A
3 x 460 V	11.0 A
Max. primary current ($I_{1\text{max}}$)	
3 x 380 V	20.3 A
3 x 400 V	19.7 A
3 x 460 V	17.3 A
Mains fuse protection	35 A slow-blow
Mains voltage tolerance	-10 / +15%
Grid frequency	50/60 Hz
Cos phi (1)	0.99
Max. permitted mains impedance Z_{max} at PCC ¹⁾	96 mOhm
Recommended residual current circuit breaker	Type B
Welding current range (I_2)	
MIG/MAG	3 - 320 A
TIG	3 - 320 A
MMA	10 - 320 A
Welding current at 10 min / 40 °C (104 °F) $U_1 = 380 - 460 \text{ V}$	40% / 320 A 60% / 260 A 100% / 220 A
Output voltage range according to standard characteristic (U_2)	
MIG/MAG	14.2 - 30.0 V
TIG	10.1 - 22.8 V
MMA	20.4 - 32.8 V
Open circuit voltage (U_0 peak/ U_0 r.m.s)	82 V
Degree of protection	IP 23
Type of cooling	AF
Overvoltage category	III
Pollution degree according to IEC60664	3
EMC device class	A ²⁾
Safety symbols	S, CE, CSA
Dimensions L x W x H	706 x 300 x 510 mm 27.8 x 11.8 x 20.1 in.
Weight	34.7 kg / 78.9 lb.
Max. noise emission (LWA)	69 dB (A)
Max. shielding gas pressure	7 bar / 101 psi

Coolant	Original Fronius
Wire speed	1 - 25 m/min / 40 - 980 ipm
Wire drive	4-roller drive
Wire diameter	0.8 - 1.6 mm / 0.03 - 0.06 in.
Wirespool diameter	max. 300 mm / max. 11.8 in.
Wirespool weight	max. 19.0 kg / max. 41.9 lb.
Idle state power consumption at 400 V	34.7 W
Power source efficiency at 320 A / 32.8 V	89%

The wirefeeder for the TPS 320i C /nc is integrated in the power source.

- 1) Interface to a 230/400 V and 50 Hz public grid
- 2) An emission class A device is not designed for use in residential areas supplied with power from a public low-voltage grid.
The electromagnetic compatibility can be influenced by conducted or radiated radio frequencies.

TPS 320i C /S/nc

Mains voltage (U_1)	3 x 460 / 575 V
Max. effective primary current ($I_{1\text{eff}}$)	
3 x 460 V	11.6 A
3 x 575 V	10.0 A
Max. primary current ($I_{1\text{max}}$)	
3 x 460 V	18.3 A
3 x 575 V	15.7 A
Mains fuse protection	20 A slow-blow
Mains voltage tolerance	-10 / +10%
Grid frequency	50/60 Hz
Cos phi (1)	0.99
Recommended residual current circuit breaker	Type B
Welding current range (I_2)	
MIG/MAG	3 - 320 A
TIG	3 - 320 A
MMA	10 - 320 A
Welding current at 10 min / 40 °C (104 °F) $U_1 = 460 - 575$	40% / 320 A 60% / 260 A 100% / 220 A
Output voltage range according to standard characteristic (U_2)	
MIG/MAG	14.2 - 30.0 V
TIG	10.1 - 22.8 V
MMA	20.4 - 32.8 V
Open circuit voltage (U_0 peak/ U_0 r.m.s)	85 V
Degree of protection	IP 23
Type of cooling	AF
Overvoltage category	III
Pollution degree according to IEC60664	3
Safety symbols	S, CSA
Dimensions L x W x H	706 x 300 x 510 mm 27.8 x 11.8 x 20.1 in.
Weight	33.11 kg / 73.0 lb.
Max. noise emission (LWA)	69 dB (A)
Max. shielding gas pressure	7 bar / 101 psi
Coolant	Original Fronius
Wire speed	1 - 25 m/min / 40 - 980 ipm
Wire drive	4-roller drive
Wire diameter	0.8 - 1.6 mm / 0.03 - 0.06 in.

Wirespool diameter	max. 300 mm / max. 11.8 in.
Wirespool weight	max. 19.0 kg / max. 41.9 lb.
Idle state power consumption at 400 V	34.7 W
Power source efficiency at 320 A / 32.8 V	89%

The wirefeeder for the TPS 320i C is integrated in the power source.

**TPS 320i
C /MV/nc**

Mains voltage (U_1)	3 x 200 / 230 / 380 / 400 / 460 V
Max. effective primary current ($I_{1\text{eff}}$)	
3 x 200 V	22.2 A
3 x 230 V	19.5 A
3 x 380 V	12.9 A
3 x 400 V	12.5 A
3 x 460 V	11.0 A
Max. primary current ($I_{1\text{max}}$)	
3 x 200 V	35.1 A
3 x 230 V	30.7 A
3 x 380 V	20.4 A
3 x 400 V	19.8 A
3 x 460 V	17.3 A
Mains fuse protection	
3 x 200 / 230 V	35 A slow-blow
3 x 380 / 400 / 460 V	35 A slow-blow
Mains voltage tolerance	-10 / +15%
Grid frequency	50/60 Hz
Cos phi (1)	0.99
Max. permitted mains impedance Z_{max} at PCC ¹⁾	96 mOhm
Recommended residual current circuit breaker	Type B
Welding current range (I_2)	
MIG/MAG	3 - 320 A
TIG	3 - 320 A
MMA	10 - 320 A
Welding current at 10 min/40 °C (104 °F)	
$U_1 = 200 - 230 \text{ V}$	40% / 320 A 60% / 260 A 100% / 220 A
$U_1 = 380 - 460 \text{ V}$	40% / 320 A 60% / 260 A 100% / 220 A
Output voltage range according to standard characteristic (U_2)	
MIG/MAG	14.2 - 30.0 V
TIG	10.1 - 22.8 V
MMA	20.4 - 32.8 V
Open circuit voltage (U_0 peak/ U_0 r.m.s)	82 V
Degree of protection	IP 23

Type of cooling	AF
Overvoltage category	III
Pollution degree according to IEC60664	3
EMC device class	A ²⁾
Safety symbols	S, CE, CSA
Dimensions L x W x H	706 x 300 x 510 mm 27.8 x 11.8 x 20.1 in.
Weight	34.7 kg / 78.9 lb.
Max. noise emission (LWA)	69 dB (A)
Max. shielding gas pressure	7 bar / 101 psi
Coolant	Original Fronius
Wire speed	1 - 25 m/min / 40 - 980 ipm
Wire drive	4-roller drive
Wire diameter	0.8 - 1.6 mm / 0.03 - 0.06 in.
Wirespool diameter	max. 300 mm / max. 11.8 in.
Wirespool weight	max. 19.0 kg / max. 41.9 lb.
Idle state power consumption at 400 V	34.7 W
Power source efficiency at 320 A / 32.8 V	89%

The wirefeeder for the TPS 320i C nc MV is integrated in the power source.

- 1) Interface to a 230/400 V and 50 Hz public grid
- 2) An emission class A device is not designed for use in residential areas supplied with power from a public low-voltage grid.
The electromagnetic compatibility can be influenced by conducted or radiated radio frequencies.

Radio parameters Conformity with Directive 2014/53 / EU - Radio Equipment Directive (RED)

The following table contains the frequency ranges and maximum HF transmission power used by Fronius wireless products sold in the EU in accordance with Article 10.8 (a) and 10.8 (b) of the RED.

Frequency range Channels used Power	Modulation
2412 - 2462 MHz Channel: 1 - 11 b ,g, n HT20 Channel: 3 - 9 HT40 < 16 dBm	802.11b: DSSS (1Mbps DBPSK, 2Mbps DQPSK, 5.5/11Mbps CCK) 802.11g: OFDM (6/9Mbps BPSK, 12/18Mbps QPSK, 24/36Mbps 16-QAM, 48/54Mbps 64- QAM) 802.11n: OFDM (6.5Mbps BPSK, 13/19 Mbps QPSK, 26/39 Mbps 16-QAM, 52/58.5/65Mbps 64- QAM)
13.56 MHz -14.6 dB μ A/m at 10 m	Functions: R/W, card emulation and P2P Protocol standards: ISO 14443A/B, ISO15693, ISO18092, NFCIP-2, Data rate: 848 kbps Reader/Writer, Card Emulation, Peer to Peer Modes
2402 - 2482 MHz 0 - 39 < 4 dBm	GFSK

FRONIUS INTERNATIONAL GMBH

Froniusstraße 1
A-4643 Pettenbach
AUSTRIA
contact@fronius.com
www.fronius.com

Under **www.fronius.com/contact** you will find the addresses
of all Fronius Sales & Service Partners and locations



Find your
spareparts online



spareparts.fronius.com