

ZAXIS33U



Shown equipped with 1.52 m arm, additional counterweight, armrest and extra piping as optional items.



HYDRAULIC EXCAVATOR

Model Code : ZX33U-5A
Engine Rated Power : 21.2 kW (28.4 HP)
Operating Weight : Canopy 3 030 - 3 540 kg
Cab 3 200 - 3 720 kg
Backhoe Bucket : ISO Heaped : 0.08 m³

Shown equipped with 1.52 m arm, additional counterweight, extra piping and cab as optional items.

Trustworthy and User-Friendly New Compact Excavators

The new series of Hitachi compact excavators has evolved even more. We listen to customers' needs, provide solutions, and adopt fresh ideas into our new products.

The outcome is new excavators that are compact, productive and nimble.

The round body is smart and its wide-opening covers provide direct access to service points for quick maintenance.

The operator station is full of easy-to-use controls, an informative multi-monitor, and comfortable operator seat. A low fuel consumption design ensures better fuel efficiency.



Shown equipped with 1.52 m arm, additional counterweight, armrest, extra piping and pre-cleaner as optional items.

HIGH PERFORMANCE

- Swift actions in narrow work place
- Excellent controllability
- Reduced fuel consumption

OPERATOR COMFORT

- Pleasant operator environment
- Sturdy operator stations by rigorous safety standards
- Easy-to-read multi-monitor

SIMPLIFIED MAINTENANCE

- Open-wide covers for easy maintenance
- Easy-to-clean cab floor
- Sloped track frame tops for easy mud removal

DURABILITY

- A line of Hitachi quality products
- Strong front attachment
- Rugged box-section blade
- Sturdy upperstructure



Shown equipped with 1.52 m arm, additional counterweight, cab and extra piping and as optional items.

Notes: Standard and optional equipment may vary by country, so please consult your Hitachi dealer for details.

HIGH PERFORMANCE

Agility Stands for Efficiency

Swift Actions in Narrow Work Place

Short rear-end swing design allows for safe, confident operation in tight work areas.



Shown equipped with 1.52 m arm, additional counterweight, cab and extra piping and as optional items.



Excellent Controllability

The Hitachi pilot control system is impressive. The control lever provides excellent fine control and low-effort handling to reduce operator fatigue. It is ergonomically positioned for easy operation. The multi-monitor allows selection of ECO and PWR modes to control the motion speed. With the engine control dial, you can also adjust engine speed with ease. The auto speed change system shifts down travel speed when the load exceeds a certain limit (for instance, when going downhill), and shifts up when the load is less.



Control lever Shown equipped with cab, armrests, air conditioner, pedal and FM/AM radio as optional items.



Shown equipped with auxiliary function lever and cab as optional items.

ECO / PWR mode selector switch **Engine control dial**





Reduced Fuel Consumption

A new engine has an electronic governor that is a clue to low fuel consumption. With an electronic accelerator, you can achieve precision engine control for fuel economy. To conserve fuel, select ECO mode, and to get more power, select PWR mode. In short, you can choose an optimum mode according to job needs.

The Auto Idle helps save fuel consumption, too. When moving the control lever to neutral, the Auto Idle automatically reduces engine speed to idling level four seconds later, reducing fuel consumption.

Shown equipped with 1.52 m arm, additional counterweight, armrests and extra piping as optional items.

OPERATOR COMFORT

Comfortable Operator Stations to Yield High Production



Shown equipped with cab, suspension seat, armrests, FM/AM radio, auxiliary function lever, air conditioner and pedal as optional items.



Pleasant Operator Environment

Hitachi cabs and canopies have been traditionally praised for operator comfort. They are spacious with ample leg room. The console and seat are designed ergonomically, standing for operator comfort.

When sitting in the operator station, the operator will not feel restricted. Cab door width increases by 80 mm for easy access and a better view of work place. The front windshield is enlarged for higher visibility. The foot step is lowered for easy access. A host of devices, including arm rests, drink holder and seat back box, enhance operator comfort.

Sturdy Operator Stations by Rigorous Safety Standards

The rugged cab and 4-pillar canopy well protect the operator in case of tipping. They are ruggedly designed by the ROPS* standard. All the models are protected with the OPG** top guard against falling objects.

A seat belt, pilot control shut-off lever, swing parking brake and travel parking brake are all standard. The neutral engine start system further enhances safe operation, disabling engine starting unless the lever is in lock position.

*Roll-Over Protection Structure

**Operator Protection Guard



Shown equipped with armrests, FM/AM radio, cab, air conditioner, pedal, spare power supply and suspension seat as optional items.

Easy-to-Read Multi-Monitor

The multi-monitor is bright, informative and easy-to-read, displaying machine conditions, settings and warnings. A clock is newly added.

- 1 Menu/Return Switch**
- 2 Auto-Idle Selector Switch**
- 3 ECO/PWR Mode Selector Switch**

Items

- Coolant Temperature Gauge
- Fuel Gauge
- Hour Meter
- Clock
- Travel Mode Indicator
- Work Light Indicator
- Overheat Indicator
- Engine Oil Pressure Indicator
- Preheat Indicator
- Fuel Level Indicator



Shown equipped with cab, air conditioner and spare power supply as optional items.

SIMPLIFIED MAINTENANCE

Easy Servicing, Day-in Day-out

Open-Wide Covers for Easy Maintenance

All covers are wide-opening for direct access to service points, allowing for quick daily inspection and replacement. A cover adjacent to the radiator extends vertically to easily clean the radiator. A refueling port is placed inside the cover to avoid dirt entry and fuel theft. A new tank cover is lightweight and wide-opening for easy refueling.

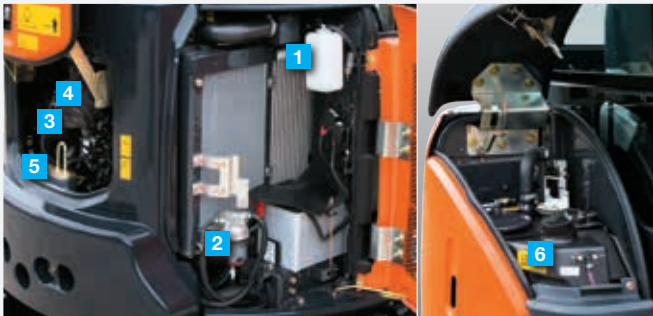

- 1 Reserve tank
- 2 Water separator
- 3 Fuel filter
- 4 Air filter
- 5 Engine oil filter
- 6 Fuel tank



Shown equipped with cab and additional counterweight as optional items.



Easy-to-Clean Cab Floor

The radiator and oil cooler are arranged in parallel, instead of conventional in-line arrangement, to promote easy, efficient cleaning and cooling. Their wavy fins can be easily cleaned by air blowing.

Dust-proof indoor nets provide for easy removal of debris and dirt. A split-type floor mat can easily be removed at a seam between foot pedals and cab floor, and its surface patterns allow for quick sweeping.

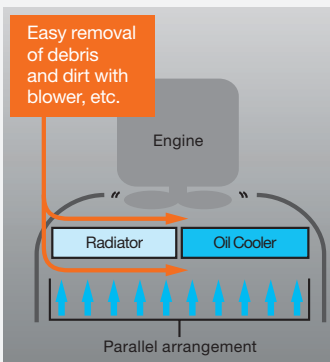

Parallel arrangement of radiator and oil cooler



Dust-proof indoor net (optional)

Sloped Track Frame Tops for Easy Mud Removal

Track frame tops are sloped to let mud slide away, curbing mud packing.

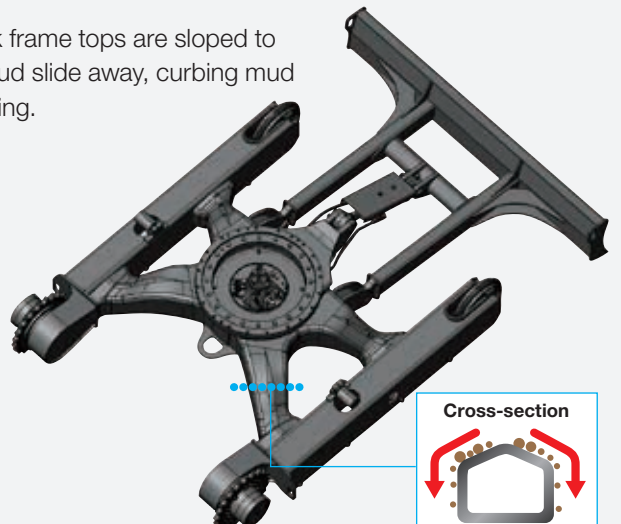

Split-type floor mat

DURABILITY

Technological Prowess and Stringent Quality Control

A Line of Hitachi Quality Products

Hitachi has been acclaimed worldwide for technological prowess and high-performance products since the launch of its first hydraulic excavator in 1949. Its Design Division has adopted the 3D-CAD system for applied analysis and data crunching to churn out quality products and slash lead time in development.

Newly developed products have been vigorously tested in multiple ways, such as long-hours durability test and evaluation test, at a Hitachi vast 427 hectares test field under critical operating conditions – for instance, tropical or freezing weather -- before unveiling new products.



Strong Front Attachment

Front pins are jointed with a tight fit to reduce jerking and noise significantly, enhancing durability. Those pins are lubricated with HN bushings having an abundant grease-retaining capacity, extending greasing intervals up to 500 hours.

Main hoses are sheathed with hose protectors at the swing post. The bottom side of the boom cylinder is protected with a V-shaped boom cylinder guard. The four-side reinforced arm is sturdy with high rigidity.

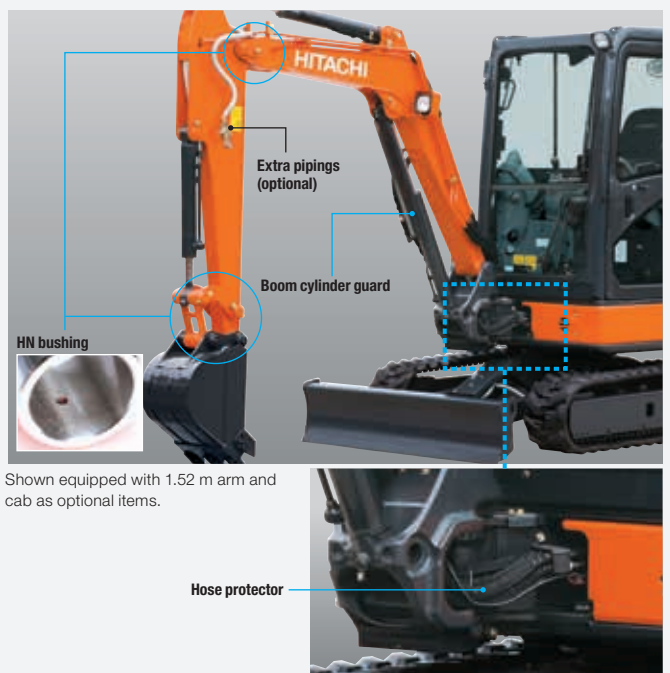



Rugged Box-Section Blade

The blade is box-section structure for higher ruggedness, and its stays have openings for easy flow-out of mud.

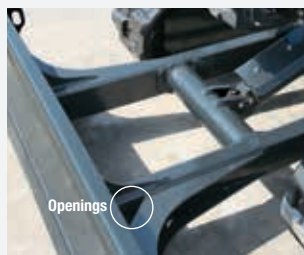

Box-section blade



D-section frame skirt

Sturdy Upperstructure

The upperstructure frame is reinforced with job-proven D-section skirts whose height is increased for larger cross section to boost durability against obstacles.



Shown equipped with 1.52 m arm, cab, additional counterweight, and extra piping as optional items.

SPECIFICATIONS

ENGINE

Model	Yanmar 3TNV88
Type	4-cycle water-cooled, direct injection
No. of cylinders	3
Rated power	
ISO 9249, net	21.2 kW (28.4 HP) at 2 400 min ⁻¹ (rpm)
EEC 80/1269, net	21.2 kW (28.4 HP) at 2 400 min ⁻¹ (rpm)
SAE J1349, net	21.2 kW (28.4 HP) at 2 400 min ⁻¹ (rpm)
Maximum torque	105.5 Nm (10.8 kgfm) at 1 000 min ⁻¹ (rpm)
Piston displacement	1.642 L
Bore and stroke	88 mm x 90 mm
Batteries	1 x 12 V / 55 Ah

HYDRAULIC SYSTEM

Hydraulic Pumps

Main pumps	2 variable displacement axial piston pumps 1 gear pump
Maximum oil flow	2 x 38.4 L/min 1 x 22.8 L/min
Pilot pump	1 gear pump
Maximum oil flow	10.8 L/min

Hydraulic Motors

Travel	2 variable displacement axial piston motors
Swing	1 axial piston motor

Relief Valve Settings

Implement circuit	24.5 MPa (250 kgf/cm ²)
Swing circuit	16.7 MPa (170 kgf/cm ²)
Travel circuit	24.5 MPa (250 kgf/cm ²)
Pilot circuit	3.9 MPa (40 kgf/cm ²)

Hydraulic Cylinders

	Quantity	Bore	Rod diameter	Stroke
Boom (canopy)	1	80 mm	45 mm	579 mm
Boom (cab)	1	80 mm	45 mm	563 mm
Arm	1	70 mm	40 mm	546 mm
Bucket	1	65 mm	40 mm	435 mm
Blade	1	85 mm	45 mm	135 mm
Boom swing	1	85 mm	45 mm	525 mm

UPPERSTRUCTURE

Revolving Frame

D-section frame for resistance to deformation.

Swing Device

Axial piston motor with planetary reduction gear is bathed in oil. Swing circle is single-row. Swing parking brake is spring-set/hydraulic-released disc type.

Swing speed	9.1 min ⁻¹ (rpm)
Swing torque	5.1 kNm (520 kgfm)

Operator's Cab

Independent spacious cab, 1 049 mm wide by 1 611 mm high, conforming to ISO* Standards. Reinforced glass windows on 4 sides for visibility. Front windows (upper and lower) can be opened. Reclining seat.

* International Organization for Standardization

UNDERCARRIAGE

Tracks

Tractor-type undercarriage. Welded track frame using selected materials. Side frame welded to track frame.

Numbers of Rollers on Each Side

Upper roller	1
Lower rollers	4

Travel Device

Each track driven by 2-speed axial piston motor. Parking brake is spring-set/hydraulic-released disc type. Automatic transmission system: High-Low.

Travel speeds	High : 0 to 4.3 km/h Low : 0 to 2.8 km/h
---------------------	---

Maximum traction force 27 kN (2 750 kgf)

Gradeability

58% (30 degree) continuous

SERVICE REFILL CAPACITIES

Fuel tank	42.0 L
Engine coolant	3.9 L
Engine oil	7.2 L
Travel device (each side)	0.6 L
Hydraulic system	56.0 L
Hydraulic oil tank	32.0 L

WEIGHTS AND GROUND PRESSURE

Operating Weight and Ground Pressure

4-PILLAR CANOPY

Shoe type	Shoe width	Arm length	kg	kPa (kgf/cm ²)
Rubber shoe	300 mm	1.17 m	3 030	28 (0.28)
		1.52 m	3 330*	30 (0.31)*
Grouser shoe	300 mm	1.17 m	3 170	29 (0.30)
		1.52 m	3 470*	31 (0.32)*
Pad crawler shoe	300 mm	1.17 m	3 240	30 (0.30)
		1.52 m	3 540*	32 (0.32)*

Including 0.08 m³ (ISO heaped), bucket weight (73 kg).

* Including 0.06 m³ (ISO heaped), bucket weight (67 kg), additional counterweight (190 kg).

CAB

Shoe type	Shoe width	Arm length	kg	kPa (kgf/cm ²)
Rubber shoe	300 mm	1.17 m	3 200	30 (0.30)
		1.52 m	3 510*	32 (0.32)*
Grouser shoe	300 mm	1.17 m	3 340	31 (0.31)
		1.52 m	3 650*	33 (0.33)*
Pad crawler shoe	300 mm	1.17 m	3 410	31 (0.32)
		1.52 m	3 720*	33 (0.34)*

Including 0.08 m³ (ISO heaped), bucket weight (73 kg).

* Including 0.06 m³ (ISO heaped), bucket weight (67 kg), additional counterweight (190 kg).

BUCKET AND ARM DIGGING FORCE

Arm length	1.17 m	1.52 m
Bucket digging force ISO	27.2 kN (2 770 kgf)	
Bucket digging force SAE : PCSA	22.9 kN (2 340 kgf)	
Arm crowd force ISO	16.9 kN (1 720 kgf)	14.6 kN (1 490 kgf)
Arm crowd force SAE : PCSA	15.8 kN (1 610 kgf)	13.9 kN (1 420 kgf)

SPECIFICATIONS

WORKING RANGES

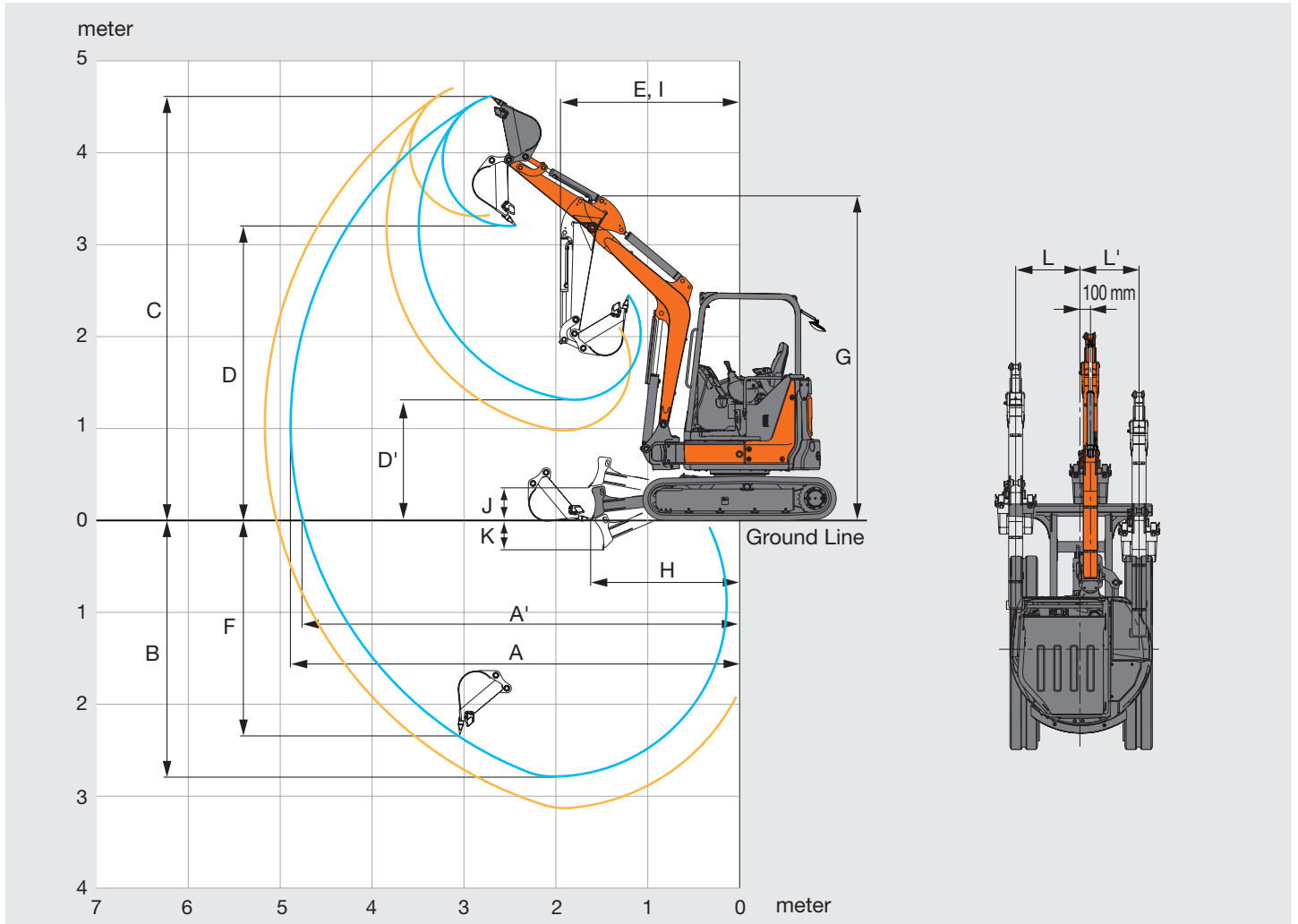

Unit: mm

Arm length	1.17 m		1.52 m	
	4-Pillar Canopy	Cab	4-Pillar Canopy	Cab
A Max. digging reach	4 890		5 170	
A' Max. digging reach (on ground)	4 750		5 040	
B Max. digging depth	2 790		3 130	
C Max. cutting height	4 620	4 420	4 700	4 470
D Max. dumping height	3 200	3 030	3 310	3 100
D' Min. dumping height	1 310	1 220	980	870
E Min. swing radius	1 970	2 150	2 090	2 180
F Max. vertical wall digging depth	2 330		2 530	
G Front height at Min. swing radius	3 530	3 440	3 560	3 460
H Min. level crowding distance	1 610		1 480	
I Working radius at Min. swing radius (Max. boom-swing angle)	1 580	1 820	1 680	1 860
J Blade bottom highest position above ground	360		360	
K Blade bottom lowest position above ground	320		320	
L/L' Offset distance	610 / 735	610 / 700	610 / 735	610 / 700
with hose rupture valve	520 / 735	520 / 700	520 / 735	520 / 700
with assist pipes	450 / 700	450 / 700	450 / 700	450 / 700
Max. boom-swing angle (deg.)	72 / 62	62 / 62	72 / 62	62 / 62
with hose rupture valve (deg.)	72 / 52	62 / 52	72 / 52	62 / 52
with assist pipes (deg.)	62 / 45	62 / 45	62 / 45	62 / 45

Excluding track shoe lug.

DIMENSIONS

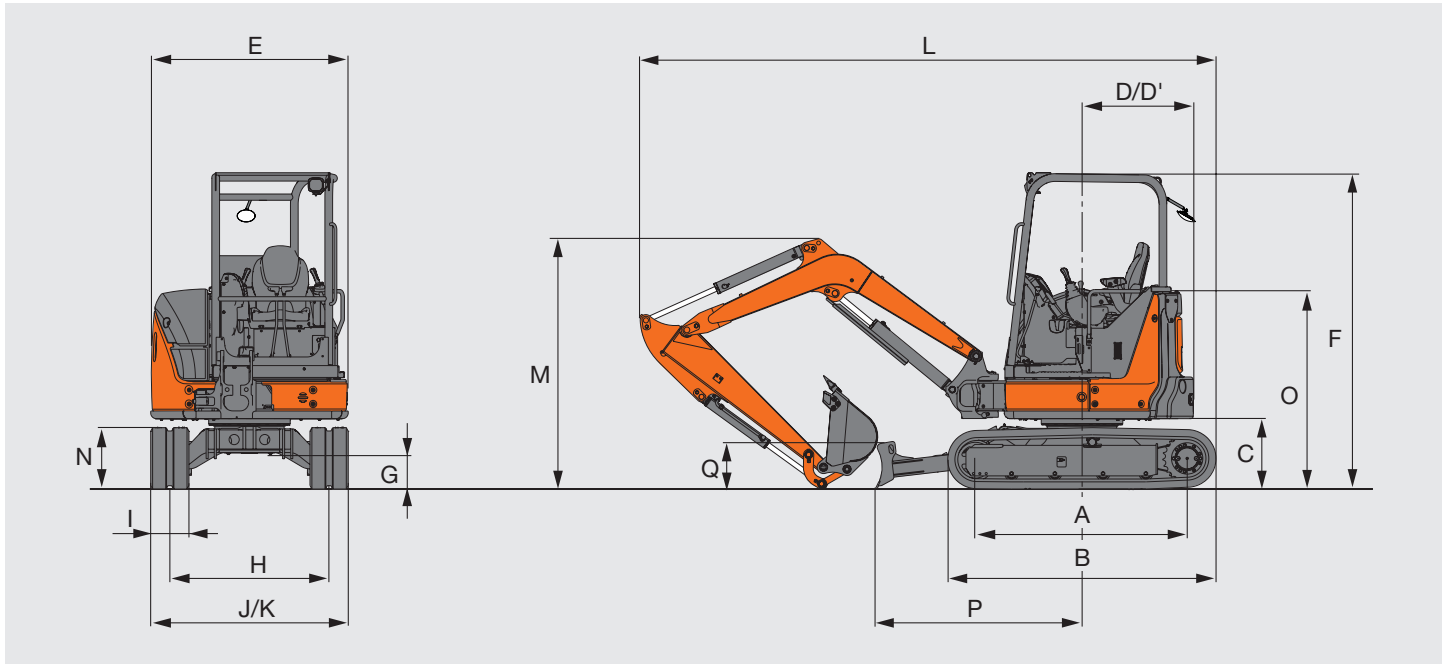

Unit: mm











	ZX33U-5A
A Distance between tumbler	1 660 (1 670)
B Undercarriage length	2 110 (2 130)
* C Counterweight clearance	550 (540)
D Rear-end swing radius	775 (875 with additional counterweight)
D' Rear-end length	875
E Overall width of upperstructure	1 550
F Overall height of cab	2 480 (2470)
* G Min. ground clearance	280 (270)
H Track gauge	1 250
I Track shoe width	300
J Undercarriage width	1 550
K Overall width (Blade width)	1 550
L Overall length	
With 1.17 m arm	4 450
With 1.52 m arm	4 530
* M Overall height of boom	
With 1.17 m arm	1 510
With 1.52 m arm	1 950
N Track height	480 (470)
O Engine cover-height	1 530 (1 520)
P Horizontal distance to blade	1 620
Q Blade height	360

* Excluding track shoe lug Data in () are dimensions of grouser shoe.

LIFTING CAPACITIES (Without bucket)











ZX33U-5A 4-Pillar Canopy Version, Blade above Ground

 Rating over-front  Rating over-side or 360 degrees Unit: 1 000 kg



Conditions	Load point height m	Load radius								At max. reach		
		1.0 m		2.0 m		3.0 m		4.0 m				meter
												
Boom 2.28 m	3									0.53	0.41	3.97
Arm 1.52 m	2					0.82	0.63	0.52	0.40	0.45	0.34	4.39
Additional counterweight 190 kg	1					0.77	0.58	0.50	0.39	0.42	0.32	4.50
Rubber shoe 300 mm	0 (Ground)			1.40	0.99	0.74	0.55	0.49	0.37	0.44	0.33	4.33
	-1	*1.47	*1.47	1.40	0.99	0.73	0.55			0.52	0.39	3.84
	-2			1.44	1.03					0.84	0.63	2.80











ZX33U-5A 4-Pillar Canopy Version, Blade on Ground

 Rating over-front  Rating over-side or 360 degrees Unit: 1 000 kg

Conditions	Load point height m	Load radius								At max. reach		
		1.0 m		2.0 m		3.0 m		4.0 m				meter
												
Boom 2.28 m	3									*0.62	0.41	3.97
Arm 1.52 m	2					*0.86	0.63	*0.78	0.40	*0.60	0.34	4.39
Additional counterweight 190 kg	1					*1.19	0.58	*0.89	0.39	*0.64	0.32	4.50
Rubber shoe 300 mm	0 (Ground)			*1.48	0.99	*1.40	0.55	*0.96	0.37	*0.75	0.33	4.33
	-1	*1.47	*1.47	*2.38	0.99	*1.35	0.55			*0.90	0.39	3.84
	-2			*1.51	1.03					*0.90	0.63	2.80











ZX33U-5A 4-Pillar Canopy Version, Blade above Ground

 Rating over-front  Rating over-side or 360 degrees Unit: 1 000 kg

Conditions	Load point height m	Load radius								At max. reach		
		1.0 m		2.0 m		3.0 m		4.0 m				meter
												
Boom 2.28 m	3											
Arm 1.17 m	2			1.40	1.01	0.71	0.54	0.45	0.34	0.44	0.34	4.03
Rubber shoe 300 mm	1					0.67	0.50	0.43	0.33	0.41	0.31	4.17
	0 (Ground)			1.22	0.86	0.64	0.48			0.43	0.32	4.00
	-1	*1.86	*1.86	1.24	0.87	0.64	0.48			0.52	0.40	3.47
	-2			*0.98	0.92					*0.84	0.80	2.19

ZX33U-5A 4-Pillar Canopy Version, Blade on Ground

 Rating over-front  Rating over-side or 360 degrees Unit: 1 000 kg

Conditions	Load point height m	Load radius								At max. reach		
		1.0 m		2.0 m		3.0 m		4.0 m				meter
												
Boom 2.28 m	3											
Arm 1.17 m	2			*1.48	1.01	*1.00	0.54	*0.88	0.34	*0.82	0.34	4.03
Rubber shoe 300 mm	1					*1.30	0.50	*0.95	0.33	*0.89	0.31	4.17
	0 (Ground)			*1.44	0.86	*1.44	0.48			*0.95	0.32	4.00
	-1	*1.86	*1.86	*2.16	0.87	*1.28	0.48			*0.99	0.40	3.47
	-2			*0.98	0.92					*0.84	0.79	2.19

- Notes: 1. Ratings are based on ISO 10567.
 2. Lifting capacity does not exceed 75% of tipping load with the machine on firm, level ground or 87% full hydraulic capacity.
 3. The load point is the center-line of the bucket pivot mounting pin on the arm.
 4. *Indicates load limited by hydraulic capacity.
 5. 0 m = Ground.

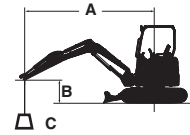

A: Load radius
 B: Load point height
 C: Lifting capacity

For lifting capacities, subtract bucket and quick hitch weight from lifting capacities without bucket.

ZX33U-5A Cab Version, Blade above Ground

Rating over-front Rating over-side or 360 degrees Unit: 1 000 kg

Conditions	Load point height m	Load radius								At max. reach		
		1.0 m		2.0 m		3.0 m		4.0 m				meter
Boom 2.28 m	3									0.57	0.44	3.97
Arm 1.52 m	2					*0.86	0.67	0.55	0.43	0.48	0.37	4.39
Additional counterweight 190 kg	1					0.82	0.62	0.53	0.41	0.45	0.34	4.50
Rubber shoe 300 mm	0 (Ground)			*1.48	1.06	0.78	0.59	0.52	0.40	0.47	0.36	4.33
	-1	*1.47	*1.47	1.49	1.06	0.78	0.58			0.55	0.42	3.84
	-2			*1.51	1.10					0.89	0.67	2.80

ZX33U-5A Cab Version, Blade on Ground

Rating over-front Rating over-side or 360 degrees Unit: 1 000 kg

Conditions	Load point height m	Load radius								At max. reach		
		1.0 m		2.0 m		3.0 m		4.0 m				meter
Boom 2.28 m	3									*0.62	0.44	3.97
Arm 1.52 m	2					*0.86	0.66	*0.78	0.43	*0.60	0.37	4.39
Additional counterweight 190 kg	1					*1.19	0.62	*0.89	0.41	*0.64	0.34	4.50
Rubber shoe 300 mm	0 (Ground)			*1.48	1.06	*1.40	0.59	*0.96	0.40	*0.75	0.36	4.33
	-1	*1.47	*1.47	*2.38	1.06	*1.35	0.58			*0.90	0.42	3.84
	-2			*1.51	1.10					*0.90	0.67	2.80

ZX33U-5A Cab Version, Blade above Ground

Rating over-front Rating over-side or 360 degrees Unit: 1 000 kg

Conditions	Load point height m	Load radius								At max. reach		
		1.0 m		2.0 m		3.0 m		4.0 m				meter
Boom 2.28 m	3											
Arm 1.17 m	2			*1.48	1.08	0.46	0.58	0.48	0.37	0.47	0.36	4.03
Rubber shoe 300 mm	1					0.71	0.54	0.47	0.36	0.44	0.33	4.17
	0 (Ground)			1.31	0.92	0.69	0.51			0.46	0.35	4.00
	-1	*1.86	*1.86	1.33	0.94	0.69	0.51			0.56	0.43	3.47
	-2			*0.98	0.98					*0.84	*0.84	2.19

ZX33U-5A Cab Version, Blade on Ground

Rating over-front Rating over-side or 360 degrees Unit: 1 000 kg

Conditions	Load point height m	Load radius								At max. reach		
		1.0 m		2.0 m		3.0 m		4.0 m				meter
Boom 2.28 m	3											
Arm 1.17 m	2			*1.48	1.08	*1.00	0.58	*0.88	0.37	*0.82	0.36	4.03
Rubber shoe 300 mm	1					*1.30	0.54	*0.95	0.36	*0.89	0.33	4.17
	0 (Ground)			*1.44	0.92	*1.44	0.51			*0.95	0.35	4.00
	-1	*1.86	*1.86	*2.16	0.94	*1.28	0.51			*0.99	0.43	3.47
	-2			*0.98	*0.98					*0.84	*0.84	2.19

EQUIPMENT

Standard and optional equipment may vary by country, so please consult your Hitachi dealer for details.

● : Standard equipment

○ : Optional equipment

ENGINE

Auto idle system	●
Cartridge-type engine oil filter	●
Dust-Proof indoor net	○
Electrical fuel feed pump	●
Fuel main filter	●
Radiator reserve tank	●
Water-separator for engine fuel	●

HYDRAULIC SYSTEM

Boom anti-drift valve	●
Full-flow filter	●
Hose rupture valve	○
Hydraulic pilot type control levers	●
Pilot control shut-off lever with neutral engine start system	●
Pilot filter	●
Suction filter	●
Swing parking brake	●
Travel parking brake	●
Two-speed travel system	●
Valve for extra piping	●

4-PILLAR CANOPY

Anti-slip plate	●
Armrests	○
Auxiliary function lever (AFL)	○
Drink holder	●
Electric horn	●
Floor mat	●
Reclining seat	○
Retractable seat belt	○
ROPS/OPG canopy	●
Spare power supply	○
Suspension seat	○

CAB

Air conditioner	○
AM/FM radio	○
Anti-slip plate	●
Armrests	○
Auxiliary function lever (AFL)	○
Defroster	●
Drink holder	●
Electric horn	●
Floor mat	●
Heater	●
Reclining seat	●
Retractable seat belt	○
ROPS/OPG cab	●
Spare power supply	○
Suspension seat	○
Window washer	●
Wiper	●

UPPERSTRUCTURE

Auxiliary overload relief valve	○
---------------------------------	---

Pilot accumulator	○
Rear view mirror	●
Stack muffler	○
190 kg additional counterweight	○

UNDERCARRIAGE

300 mm grouser shoe	○
300 mm pad crawler shoe	○
300 mm rubber shoe	●

FRONT ATTACHMENTS

Assist piping	○
Extra piping	○

MISCELLANEOUS

Theft deterrent system*	○
-------------------------	---

HN bushing	●
1.17 m arm	●
1.52 m arm	○

* Hitachi Construction Machinery cannot be held liable for theft, any system will just minimize the risk of theft.



MEMO



Built on the foundation of superb technological capabilities, Hitachi Construction Machinery is committed to providing leading-edge solutions and services to contribute as a reliable partner to the business of customers worldwide.

Hitachi Environmental Vision 2050

Our Environmental Vision envisions a low-carbon society; a resource efficient society; a harmonized society with nature. To achieve such a sustainable society, we have established a set of long-term environmental targets called Hitachi Environmental Innovation 2050.

Reducing Environmental Impact by New ZAXIS

Hitachi makes a green way to cut carbon emissions for global warming prevention according to LCA*. New ZAXIS utilizes lots of technological advances, including the new ECO mode, and Isochronous Control. Hitachi has long been committed to recycling of components, such as aluminum parts in radiators and oil cooler. Resin parts are marked for recycling.

*Life Cycle Assessment – ISO 14040

These specifications are subject to change without notice. Illustrations and photos show the standard models, and may or may not include optional equipment, accessories, and all standard equipment with some differences in color and features. Before use, read and understand the Operator's Manual for proper operation.

