

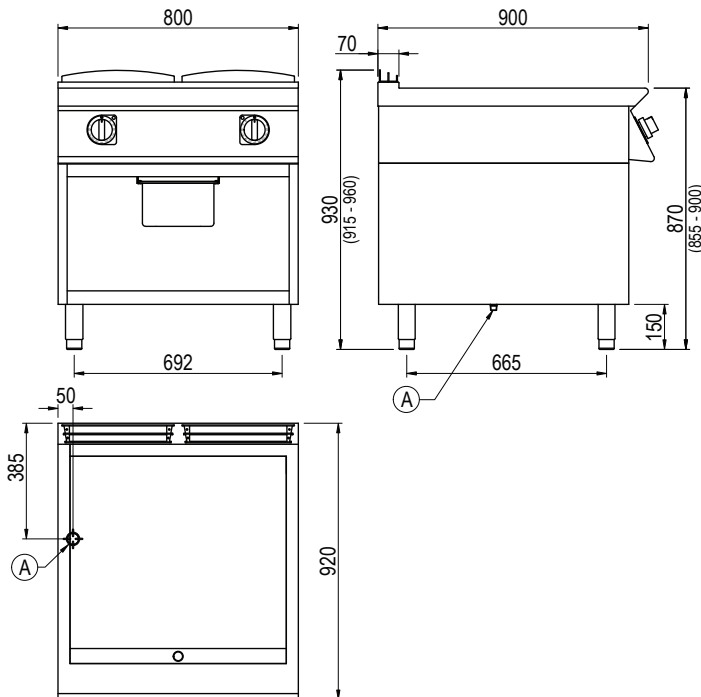

Product Information:

- Class leading, European style, professional quality and reliability since 1963
- 900 series, electric frytop with 15mm smooth satin chrome plate (17.2kW)
(also available in 15mm ribbed satin chrome plate)
- Satin chrome plate delivers a cost effective, highly durable, faster heating and easier cleaning solution than alternative plates
- Heating elements with Hi-limit temperature protection
- Temperature regulation via thermostat (50°C – 300°C)
- Indicator lights to monitor the correct operation of the appliance
- Robust 304 grade stainless steel construction with rounded corners for improved cleaning
- Hermetically sealed, pressed work surface with raised edges to protect from overflow
- Removable 1/2 GN grease tray
- Open base with optional doors available (SPGI.2016437)
- Height adjustable stainless steel feet for a 900mm working height
- 24-month warranty

General Drawing:



Specifications:

Model - Smooth	FLE941GCRXT
Model - Ribbed	FRE941GCRXT
W x D x H (mm)	800 x 920 x 930
Weight	175kg
Cooktop (mm)	720 x 640
Packed Dimensions (mm)	845 x 1025 x 1200
Packed Weight (mm)	187kg
Electrical Connection	3Ø + N + E 415VAC / 50Hz / 17.2kW

Legend:

A Electrical Connection

