

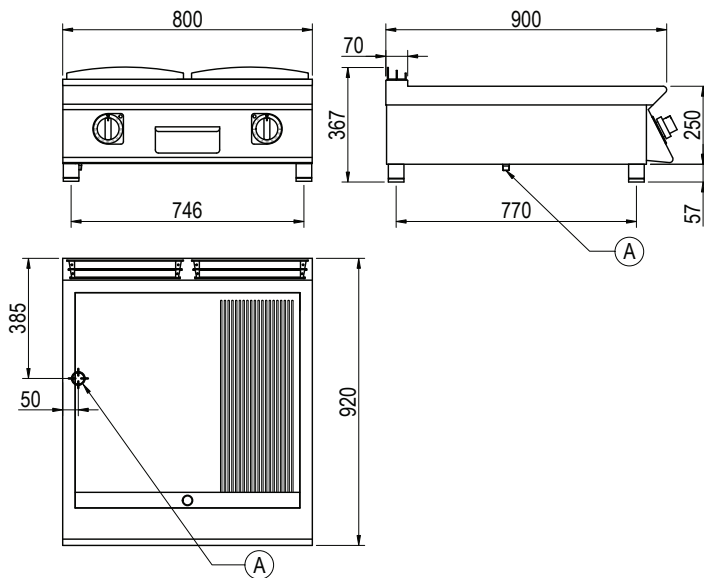

Product Information:

- Class leading, European style, professional quality and reliability since 1963
- 900 series, electric frytop with 2/3 smooth and 1/3 ribbed 12mm mild steel plate (17.2kW)
- Heating elements with HI-limit temperature protection
- Temperature regulation via thermostat (50°C – 300°C)
- Indicator lights to monitor the correct operation of the appliance
- Robust 304 grade stainless steel construction with rounded corners for improved cleaning
- Hermetically sealed, pressed work surface with raised edges to protect from overflow
- Removable grease tray
- 24-month warranty

General Drawing:



Specifications:

Model	FME941TFT
W x D x H (mm)	800 x 920 x 367
Weight	140kg
Cooktop (mm)	720 x 460
Packed Dimensions (mm)	845 x 1025 x 570
Packed Weight (mm)	152kg
Electrical Connection	3Ø + N + E 415VAC / 50Hz / 17.2kW

Legend:

A Electrical Connection

