



Gzunda Linen Mover

Operating Manual

Gzunda Linen Mover Operating Manual—OM0027E/1

This manual contains important safety, installation and operating instructions for this unit. Read this manual thoroughly and completely, and retain for future reference. This unit can cause serious injury to personnel or damage to property if used incorrectly, therefore do not use this machine for any other purpose apart from its intended use. Using this unit incorrectly may void warranty.

Any damage audible or visible to this unit should be addressed at the time of discovery. Electrodrive Pty Ltd can provide parts and service support on request through its service partner company:

Serviced Equipment Pty Ltd

p: 1300 934 471

e: service@fallshaw.com.au

Made in Australia by:

Electrodrive Pty Ltd

2A Ayton Street, Sunshine North VIC Australia 3020

p: 1300 934 471 (within Australia)

p: +61 (03) 9300 8521 (International)

e: sales@electrodrive.com.au

w: www.electrodrive.com.au

© Electrodrive

Contents

Introduction	5
Operating instructions	6
Controls	6
Driving instructions	9
Safety check	9
Hitching to a trolley	9
Steering.....	10
Unhitching.....	10
Sleep mode.....	10
Charging	10
Maintenance	12
Batteries.....	12
Drive wheel	12
Brakes.....	12
Motor	13
Electronic speed control.....	13
Fuses	13
Circuit breaker	14
Cleaning.....	14
General	14
Disposal of components or material.....	14
Warranty	15
Modifications and misuse can void your warranty	15
General wear items not covered under warranty.....	15
Appendix 1: Machine rating conditions	16
Appendix 2: Fault codes	17
Appendix 3: Motor brush replacement	18
Appendix 4: Charging procedures for SLA batteries	21
Charging setup	21

During charging	21
Charger manual	21
Appendix 5: Wiring diagram	22
Appendix 6: Spare parts list.....	23
Service Log	25

Introduction

The Gzunda Linen Mover is a battery powered mobile towing unit to assist in the movement of heavy beds and trolleys, eliminating back or shoulder strain. It is designed to save operator effort when pushing or pulling beds and trolleys.

The Gzunda Linen Mover includes the latest developments in DC motors with automatic electromagnetic park braking, as well as a high capacity programmable controller.

Features include quiet operation, ease of handling, high manoeuvrability, low maintenance, and the ability to handle heavy loads. The Gzunda Linen Mover slows and parks automatically when the twist grip is released.

Under typical operation, the Gzunda Linen Mover battery capacity should be adequate for a day's operation. Overnight charging is recommended, and in high-use situations additional "top-up" charging is advised. It is recommended to use the charger supplied with the Gzunda Linen Mover when charging the sealed maintenance-free batteries. This charger is especially designed to set the charge rate, prevent gassing, and automatically cut switch to "trickle charge" when charging is complete.

All bearings are pre-lubricated and sealed and should not require attention in normal use. Regular maintenance requirements on the vehicle are therefore minimal and are covered in this manual.

As with any machinery, safety considerations demand that the Gzunda Linen Mover be handled with caution, and only operated by trained and authorised personnel. In addition, all loads must be placed securely on the bed or trolley, and the bed or trolley securely locked to the Gzunda Linen Mover.



The Gzunda Linen Mover must only be operated by trained and authorised personnel.

Operating instructions

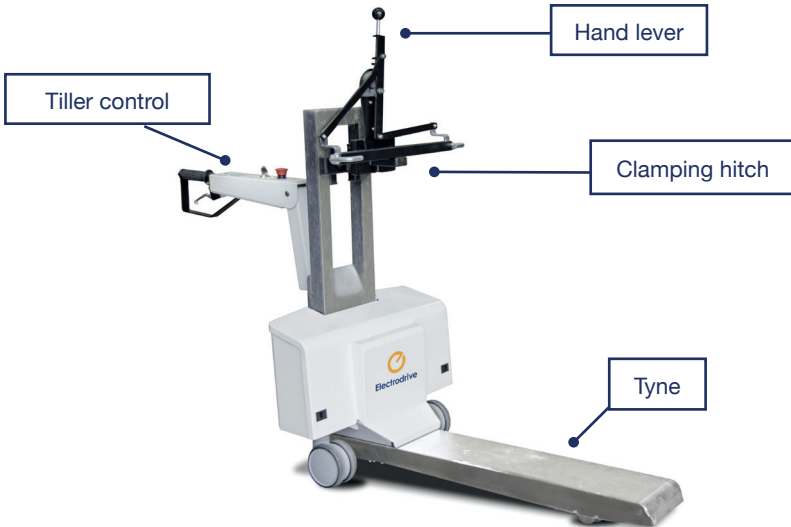

Controls

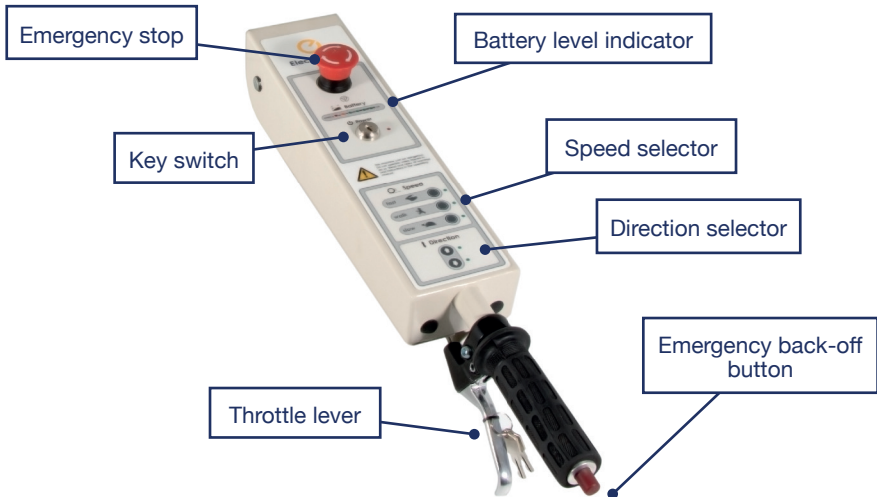

Controls

Key switch

The key switch must be turned clockwise to switch the unit on. When ON, the LED status indicator will be illuminated. If a fault occurs with the electronics, this LED light will flash an error code (refer to Appendix 2). It is important to note that the unit should be switched off and the key removed, whenever it is not in use. This eliminates the risk of unauthorised movement and also prevents an unnecessary use of battery power.

Emergency stop and back-off button

The controls have two emergency buttons.

1. Emergency stop button—in an emergency, push this button to stop the unit. To release, slightly twist the button and it will pop back up.
2. Emergency back-off button—when pressed, the unit will travel backwards, until released, to avoid pinning the operator against an obstacle.



Only use the emergency buttons in an emergency.

Direction selector

This determines the direction of travel. Push the button corresponding to the desired travel direction (forward/reverse).

Throttle lever

This lever provides variable speed control from zero up to 100% of the governed speed. Releasing the lever stops the unit.

Speed selector

The speed selector will always start in the SLOW position. Select a speed that you are comfortable using. The speed can be changed whilst driving. It is advisable that you operate this unit at a slow speed when entering a confined area.

Battery level indicator

The battery level indicator indicates the amount of charge left in the batteries. When it appears to be running low, return the unit to the closest charging station to charge the batteries. Being aware of the level of charge of the batteries will eliminate the possibility of running low on power whilst away from the charging station. Red light only indicates no usable battery power remaining.

Horn (where fitted)

Push to sound the horn, release to turn off.

Charger socket

The charger socket is located on the body panel of the unit, next to the tiller post.

Brakes

When the speed control lever is released, the unit is slowed electrically by dynamic braking until the machine and load comes to a complete stop.

Capacity

Refer to the serial plate for the unit's safe working load, located on the body adjacent to the tiller post.

Park brakes release (optional)

In the case where the unit cannot be turned on due to a flat battery, use the park brake release switch located underneath the front cover beside the controller. Use this key switch to override the motor park brake, the machine can now be manually pushed to a different location. Remove the key from the park brake release and immediately place the machine on charge when unit is at the charging station. Confirm the charger has begun to charge the batteries, leave on charge for a minimum of eight hours. If the machine is still not working call an Electrodrive service agent.

Driving instructions

Safety check

Before using the Gzunda Linen Mover the operator should complete the following check:

1. The battery charger is not connected.
2. The direction selector works.
3. The emergency stop button is released.
4. The brakes operate correctly when the throttle lever is released.
5. The battery indicator shows adequate charge.
6. There is no visible damage to the unit.

Safe operation

1. When towing a trolley in busy areas, it is recommended to set a safe speed to avoid collisions with people or objects, and use the horn if/when required.
2. Even though the electromagnetic or other interference of the Gzunda Linen Mover is not significant, it may still have an impact on some high accuracy hospital equipment. It is advised that you do not park or keep the Gzunda Linen Mover too close to this kind of equipment when they are in use.
3. Always begin driving the Gzunda Linen Mover on SLOW speed to ensure you maintain control. The Gzunda Linen Mover has an intuitive control system, so it becomes easier to use the more you use it. Select a speed that is suited to the competency of the operator. If unsure, start with SLOW speed then adjust up accordingly.

Hitching to a trolley

The Gzunda Linen Mover is fitted with a clamping hitch

The hand lever situated in the centre of the clamping hitch, opens and closes the latches that grip onto each side of the trolley.

This lever has two positions:

- **Released:** This position is used when the Gzunda is not attached. The hitch arms are at their widest, ready to attach to a trolley.
- **Locked:** This position is used when the Gzunda is attached to the trolley. The Gzunda hitch is locked over the supports, with the “arms” in their tightest position.

The Gzunda Linen Mover can also be fitted with a variety of hitches.

In all cases, ensure that the trolley being attached to has its brakes engaged (or chocked) and is free from obstruction. Inspect the trolley and ensure that the trolley castors are in good condition.



Towing a trolley with castors in poor condition can overload the Gzunda Linen Mover, and cause damage not covered under warranty.

Steering

The tiller arm provides easy steering. The Gzunda Linen Mover with an attached trolley can be manoeuvred through tight areas.



It is STRONGLY RECOMMENDED that the operator lead the Gzunda Linen Mover and trolley, rather than using the Gzunda Linen Mover to “push” the trolley.

This will ensure that the operator has a safe unobstructed view ahead.
This will also make the Gzunda Linen Mover and trolley easy to manoeuvre.

Unhitching

Always make sure the trolley is on a flat level surface. Apply the castor brakes (if fitted) or chock the wheels of the trolley before releasing it from the Gzunda Linen Mover.

Sleep mode

After a period of 30 minutes of inactivity, the Gzunda Linen Mover will switch into a sleep mode to extend battery life. To resume operation, simply reset by turning key OFF then ON.

Charging

1. Use only the supplied battery charger to charge the unit.
2. Always position the unit to allow enough space to connect or disconnect the charger socket from the unit.

Ensure regular recharging of batteries (charging overnight after a day's usage is recommended). Irregular charging may cause the batteries to prematurely fail.

Leaving a machine in storage without charge for periods greater than a month can also lead to premature battery failure. This is not covered under warranty.

For detailed charging procedures refer to Appendix 4.



Only use the battery charger supplied with this Gzunda Linen Mover.

The automatic features of the supplied charger ensures that the sealed gel batteries are not overcharged, and only a minimum amount of gas, if any at all, are expelled during charging.

Maintenance

Batteries

If the Gzunda Linen Mover is not being used for an extended period of time, it should be connected to the battery charger to check the battery level on a regular basis, and placed on charge overnight if required. This will ensure the batteries are kept in good condition.

The batteries are sealed and maintenance free. DO NOT attempt to open these batteries. If the Gzunda Linen Mover is not charged as above, the batteries may be exhausted and have dropped below the charging threshold of the battery charger. The supplied charger cannot begin to charge the batteries unless they have a small amount of charge. If this occurs, contact Electrodrive or your local service agent.

A sign that the batteries need replacing is when they no longer hold charge.



Irregular charging may cause premature battery failure. The battery can only be replaced by a qualified technician.

Drive wheel

To replace the drive wheel:

1. Turn off the machine and remove the key.
2. Loosen the chain by releasing the fasteners holding the gearbox in place.
3. Release the pressure from the jacking screw.
4. Remove the four fasteners from the bearings adjacent to the drive wheel.
5. Lower the drive wheel assembly out from the tyne including shaft, sprocket and bearings.
6. Remove bearings from shaft and transfer to new drive wheel assembly.
7. Follow above instructions in reverse order to fit new drive wheel assembly.

Brakes

The park brake does not require regular maintenance. If the Gzunda Linen Mover is not remaining stationary when in the OFF position, contact Electrodrive or your local service agent.

Motor

Motor brushes should be inspected every six months and replaced as required (see Appendix 3 for instructions).

Electronic speed control

This unit is factory programmed, and is not serviceable by the customer. The LED status indicator on the membrane console flashes to indicate a fault with the controller. The number of flashes will refer to a particular fault (see Appendix 2). Contact Electrodrive or your local service agent for diagnosis and advice.

Fuses

The control circuit is protected against inadvertent current overloads with a 1 Amp fuse. The charger circuit is protected by a 10 Amp fuse. These fuses are located next to the electronic controller on the electrical panel.

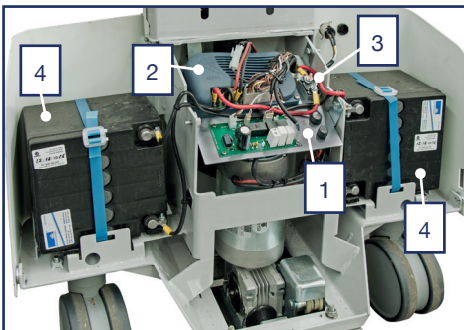

1. Fuses
2. Controller
3. Circuit breaker
4. Batteries

Circuit breaker

The Gzunda Linen Mover is fitted with a self-resetting circuit breaker in case of momentary overload. This switch can be found next to the fuses as shown.

If the circuit breaker continues to trip multiple times in succession, test the machine, as the motor may be damaged. Continued use could damage the unit further.

The controller is also equipped with safety shut down capabilities and will limit the battery current as well as detect low battery voltage.

Cleaning

To clean exterior of machine wipe surfaces down with a warm damp cloth. A mild detergent may be used for harder-to-remove grime.



Do NOT use chemical solvents, highly concentrated caustic soda or abrasive cleaning agents. These may damage the surface quality and may affect the integrity of polyurethane and machine lubricant properties.

General

Any damage audible or visible to the Gzunda Linen Mover should be addressed at the time of discovery.

When not in use the unit should be stored in a cool dry place. Please ensure it is not parked in a manner that obstructs access, causes a tripping hazard, or any other safety related issue.

Disposal of components or material

All replaced or damaged components should be disposed or recycled properly based on its category.

Warranty

Electrodrive Pty Ltd warrants that this product is free from defects in materials and workmanship for a period of twelve months from the date of dispatch from the Electrodrive plant.

If a defect is reported, Electrodrive will repair or replace the defective part, at its own discretion. This warranty does not apply if the Gzunda Linen Mover has been misused, damaged, or modified in any way.

Modifications and misuse can void your warranty

The following activities (including, but not limited to) are examples:

Modifications

- The machine is re-wired by an unauthorized service agent.
- The motor controller is re-programmed by an unauthorized service agent.
- There are modifications to the body or frame of the machine.
- Use of non-specified parts.
- The machine is serviced by an unauthorized service agent.

Misuse

- Overloading the unit either during towing or lifting.
- Carrying people or other foreign objects.
- Exposed to rain or other precipitation.
- Using the emergency back-off system to change direction regularly.
- Exposed to a corrosive environment.
- Driven off road—potholes, gravel, etc.
- Driven on slopes with a steeper gradient than 1:12.
- Not being charged adequately.
- Using the emergency stop button as an ON/OFF button.

General wear items not covered under warranty

- Castors.
- Drive wheels, motors and motor brushes.
- Hand grips.

Appendix 1: Machine rating conditions

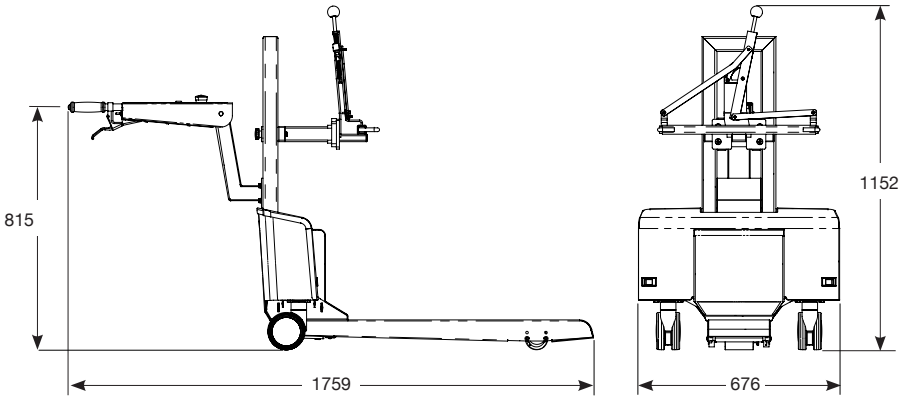

Model	Safe Working Load	Max Load
GZLINENMOVER	500 kg	500 kg























The Gzunda Linen Mover has been designed to move the rated weight capacity on a level firm surface. Variations in the working environment may impede the performance of the Gzunda Linen Mover. Such parameters include (but are not limited to) the following:

- Ramps and sloped surfaces.
- Soft surfaces (for example carpet).
- Slippery surfaces (gravel, water, oil on the ground, etc).

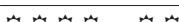

It is important that the Gzunda Linen Mover NOT to be operated outside of the recommended conditions.

Appendix 2: Fault codes

	LED codes	Explanation
LED off		No power or defective controller.
Solid on		Controller operational; No faults.
1, 1		Thermal cutback fault.
1, 2		Throttle fault.
1, 3		Speed limit pot fault.
1, 4		Undervoltage fault.
1, 5		Overtoltage fault.
2, 1		Main contactor drive 'off' fault.
2, 3		Main contactor fault.
2, 4		Main contactor drive 'on' fault.
 3, 1		HPD fault present for > 10 seconds.
3, 2		Brake 'on' fault.
3, 3		Precharge fault.
3, 4		Brake 'off' fault.
3, 5		HPD (high pedal disable) fault.
 4, 1		Current sense fault.
 4, 2		Motor voltage fault (hardware failsafe).
 † 4, 3		EEPROM fault.
 4, 4		Power section fault.

 = Must cycle keyswitch to clear.

† = Must use programmer to clear, as follows: Select 'parameters menu'; alter data vaule of any parameter; cycle keyswitch.

Note: Only one fault is indicated at a time, and faults are not queued up.

Appendix 3: Motor brush replacement

Remove the front cover of the Gzunda Linen Mover.

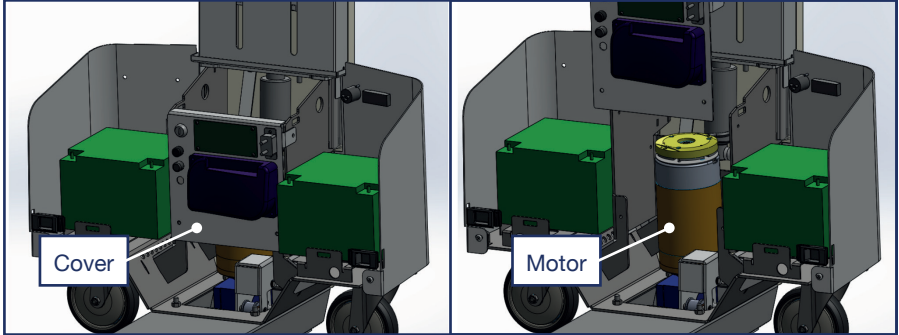

Remove the motor.

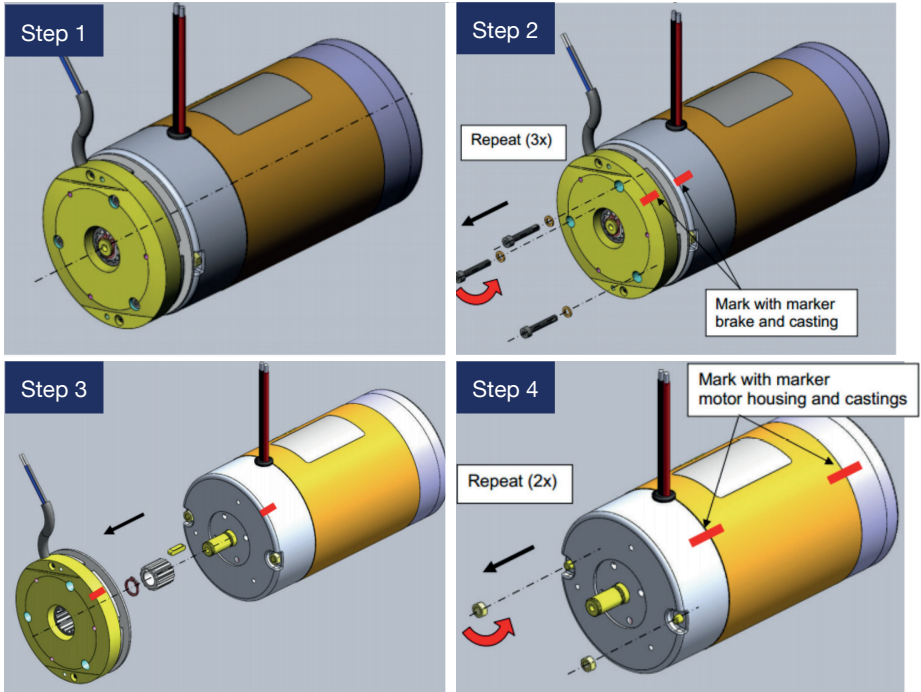

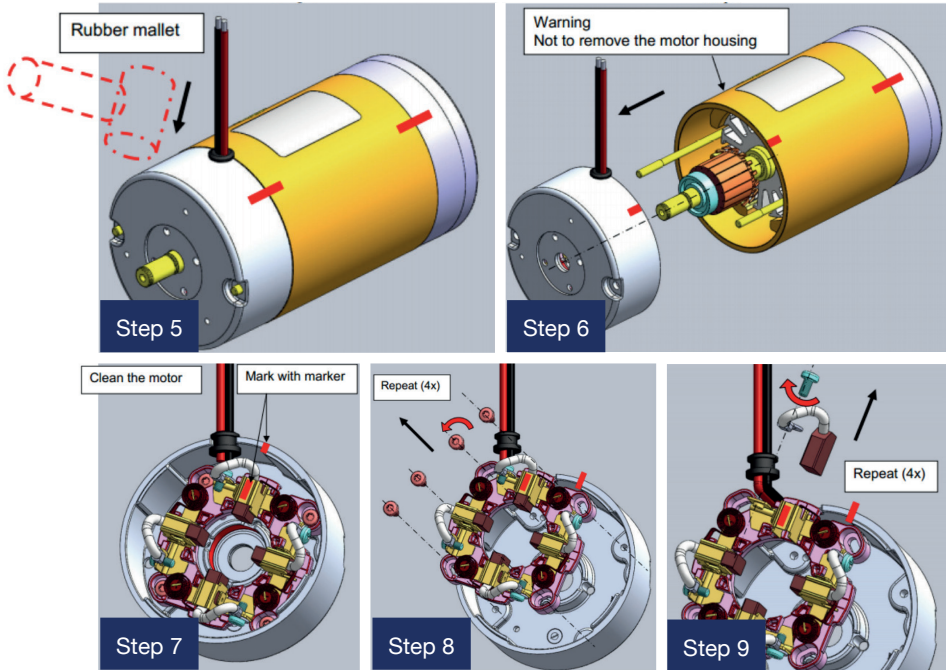

Reassemble the new brushes (4x)

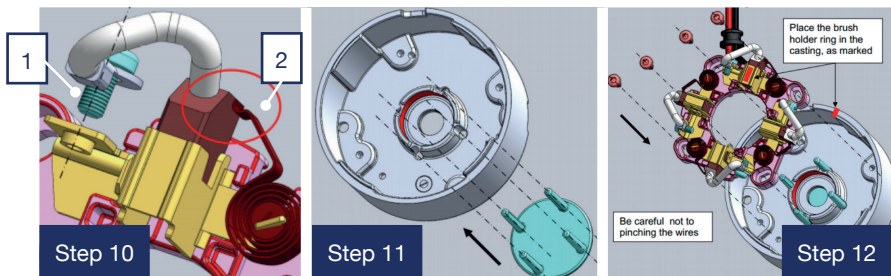

Step 10

1. Fix the screw torque 1.4 Nm
2. Place the brushes as pictured. Brushes locked.

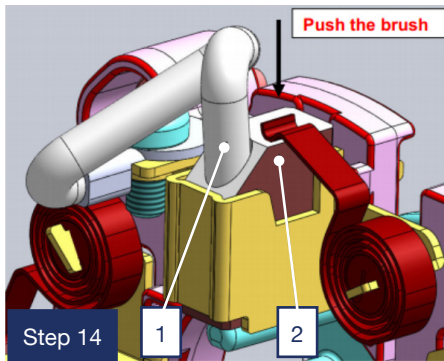
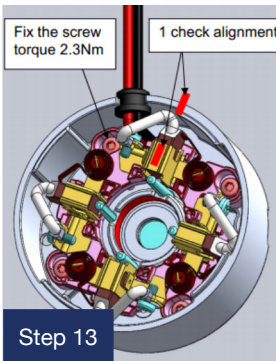

Step 14

1. Put the braid as shown in the picture.
2. Check that the spring push is on top of the brush.
3. Repeat for all brushes.

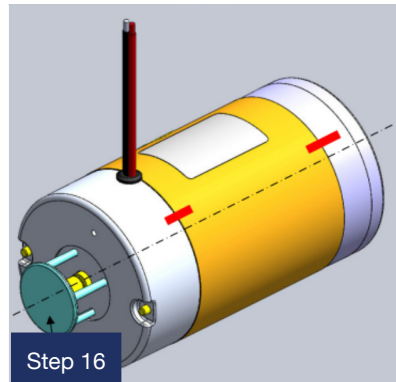
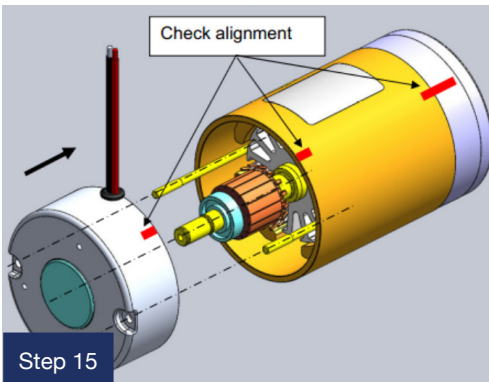

Appendix 4: Charging procedures for SLA batteries

- Always charge batteries when work is complete and the equipment is not required for use.
- Opportunity charging is NOT recommended. This can also shorten battery life.
- Never leave batteries in a discharged state as this will shorten the batteries life.
- For maximum battery life, a battery must be recharged to 100% capacity. Recharging less than 100% may result in premature battery failure. Batteries are not covered under warranty if they are not recharged properly.
- If batteries are disconnected from the machine and not used for lengthy periods of time, it is recommended to give them a maintenance charge once every two months.

Charging setup

- Ensure you have the correct charger for the batteries. The correct voltage and current is important to ensure the full life of the batteries.
- Check all connections are tight and in good condition.
- The green charger LED will illuminate to confirm charging is in progress.
- If charger lights do not come on, call your service technician.
- When charger is plugged in, drive function of machine is automatically inhibited.

During charging

- Ensure there is enough airflow to help keep the batteries as cool as possible.
- If the batteries are swollen turn off immediately and call your service technician.
- Always leave batteries on charge until the charge is COMPLETE. This is indicated when charger LED turns off.

Charger manual

Please read BA1105—Battery Charger Operating Manual for more information.

Appendix 5: Wiring diagram

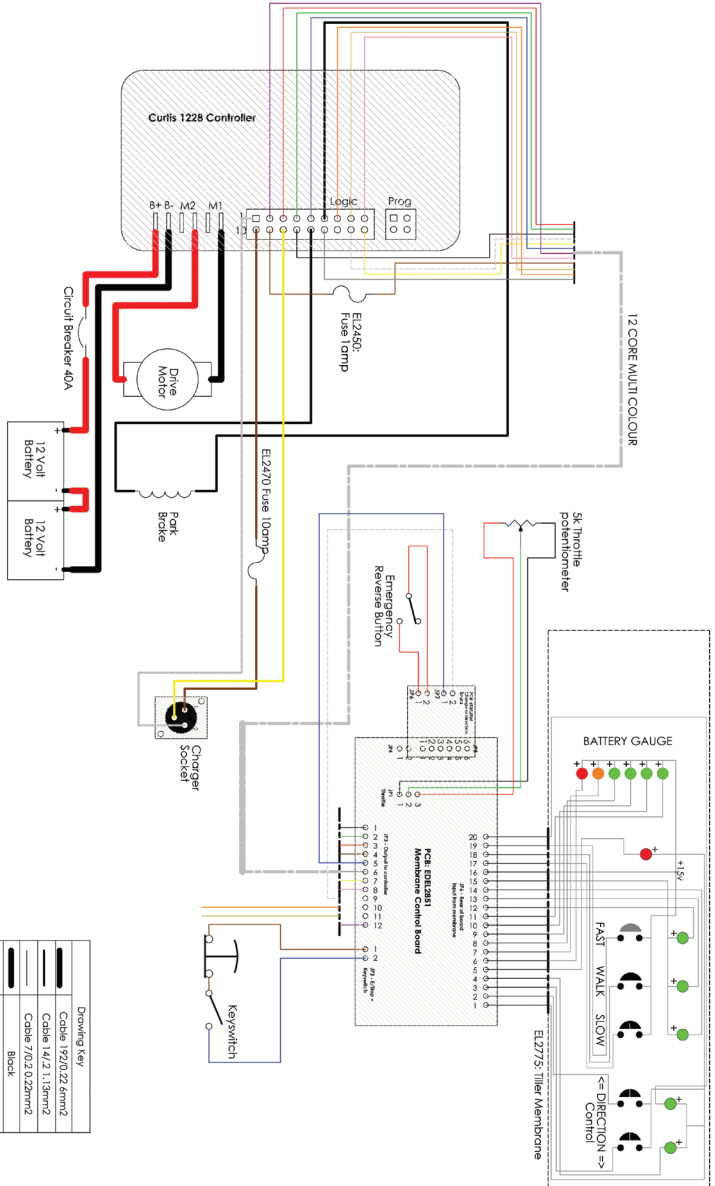

	Drawing Key
	Cable 19/20/22 6mm2
	Cable 14/2 1.13mm2
	Cable 7/0.2 0.22mm2
	Black
	Blue
	Brown
	Green
	Grey
	Orange
	Purple
	Red
	Tan
	White
	Yellow

Appendix 6: Spare parts list

Part number	Description
EDCL1052	Tiller handle membrane loom
EDCL1130	Loom—charger with socket
EDCL1141	Loom—controller suit tiller
EDGM2015	Spacer—castor spacer to suit the Gzunda
EDWH1131	Drive wheel with shaft and sprocket 075 mm D, 90mm GZ 192 mm shaft
EDGM1635	G/Box NMRV030 D63 B14 i7.5
EDMO1102	Motor Amer 300 watt motor with brake 24V MP75 B14
EDGM1680	G/box output shaft single end NMRV030
EDSP1060	Sprocket 16T Bossed 06B, 14 mm bore, 5 mm
EDBATGEL33AH	Battery 12V 33Ah AGM sealed style
EDGM1380	Chain 06B1 3/8" GZ cut to length
EDGM1770	GZ 505 chain idler nylon pulley
EDCS1070	Castor 125 mm, grey PU swivel plate mount PC guard std GZ
ED EL2052	Motor controller suit Gzunda Linen Mover
EDEL2720	Key switch with Key-A126
EDEL2500	Fuse holder panel mount
EDFA1001	Levelling feet M8x60
EDBA1105	Charger 24V 7 Amp
EDEL2380	Emergency stop button complete (large)
EDEL1910	Circuit breaker 40 Amp
EDEL3015	Potentiometer—5K self returning wig wag pot
EDGM1085	Bearing 6084LLU
EDGM1160	Bearing set for Gzunda
EDCL1150	Cable loom controller Gzunda Linen Mover
EDCL1151	Loom Gzunda Linen Mover programmer lead
EDCL1153	Loom Gzunda Linen Mover charger loom
EDEL2338	Emergency reverse button

Part number	Description
EDEL2380	Emergency stop button
EDEL2450	Fuse 1 Amp (charger) (3AG)
EDEL2470	Fuse 10 Amp (control) (3AG)
EDEL2620	Horn button (optional)
EDEL2720	Key switch with key
EDEL2775	Membrane key pad
EDEL2805	Hour meter 12-48V (optional)
EDEL3010	Potentiometer: 5k (internal)
EDGM1810	Handgrip 7/8" x 5" —tiller
EDGM2040	Spring—tiller handle position
EDGM2051	Tiller pot spring
EDGM2150	Throttle cable
EDGM2170	Throttle lever for tiller handle
EDGM2210	Tiller pin: zinc plated
EDWP1049	Tiller handle: complete

Service log

Service recommendations

To ensure this equipment is kept in a safe and reliable condition, it is important to follow a preventative maintenance program. Maintain a log of the service work on the cards below, and always use an approved Electrodrive service agent to conduct the works. Approved service personnel will be provided with all necessary documents and components in service repair, including but not limited to, circuit diagrams, component part lists, descriptions, service checklists and spare parts.

6 month service

Date of service		Service agent	
Machine serial number			
Summary of works			
Next service due			

12 month service

Date of service		Service agent	
Machine serial number			
Summary of works			
Next service due			

18 month service

Date of service		Service agent	
Machine serial number			
Summary of works			
Next service due			

24 month service

Date of service		Service agent	
Machine serial number			
Summary of works			
Next service due			

30 month service

Date of service		Service agent	
Machine serial number			
Summary of works			
Next service due			

36 month service

Date of service		Service agent	
Machine serial number			
Summary of works			
Next service due			

42 month service

Date of service		Service agent	
Machine serial number			
Summary of works			
Next service due			

48 month service

Date of service		Service agent	
Machine serial number			
Summary of works			
Next service due			

54 month service

Date of service		Service agent	
Machine serial number			
Summary of works			
Next service due			

60 month service

Date of service		Service agent	
Machine serial number			
Summary of works			
Next service due			

Mobility solutions to help you push, pull & lift with ease.

www.electrodrive.com.au