

PlateRite 4600Z/S/E **NEW**

Over 22,000
CTP units
shipped

Thermal Plate Recorder



Creating a Future in Print

Advanced 4-page thermal CtP systems with innovative optical technology deliver outstanding reliability

PlateRite 4600Z/S/E

SCREEN's new PlateRite 4600Z, S and E CtP systems enable consistent production of high-quality printing plates. The high-end PlateRite 4600Z delivers an impressive throughput of up to 33 plates per hour.

The exposure heads used in the PlateRite 4600 series have been enhanced with the addition of new fiber laser diodes. These diodes enable the reproduction of sharper halftone dots, significantly improving print quality.

All systems can also be equipped with an option that supports plate sizes smaller than the standard settings (270 x 278 mm).

High
quality

Proprietary technologies ensure stable exposure

Accurate reproduction of halftone dots with exposure heads

To ensure more stable exposure, the light source is equipped with the same proven fiber laser diodes used in the PlateRite 8600 series. The resulting changes in the laser beam produce more accurate vertical and horizontal lines, enabling sharper reproduction of halftone dots. This has led to a major increase in overall print quality.

Comparison of exposure results on thermal CtP plates

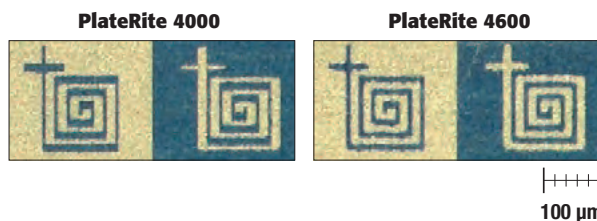

Stable drum rotation even at high speeds

Locating the light source as close as possible to the plate has enabled even sharper imaging. The use of proprietary clamp technology and an auto-balance system also makes it possible to perform stable, high-speed exposure regardless of the plate size.

Auto-balance system

The operator simply selects the appropriate pre-registered plate size and type during setup, and the PlateRite 4600 automatically makes the necessary adjustments to ensure perfect drum balance.



Automation Autoloader streamlines production

An autoloader system can be installed to automate all processes from plate loading through exposure, transport and developing to discharge. The autoloader supports extended periods of continuous operation and allows plate sizes not set in the cassette to be loaded manually during processing.



MA-L4600 multi-cassette autoloader

Accepts three cassettes containing up to 100 plates each (total of 300 plates)



SA-L4600 single-cassette autoloader

Accepts a single cassette containing up to 100 plates of the same size



More efficient setup for printer loading

Punch system (optional)

When the punch system (up to six blocks) are used, the imaged plates can be loaded directly onto the press after output. The use of printing press punch blocks during plate output eliminates the need for manual punching later on in the workflow, ensures excellent registration accuracy, and creates the foundation for perfect results on press.

Wider range of supported plate sizes

Improved support for small size plates (optional)

The newly available small size option supports minimum plate size of 270 x 278 mm (10.7" x 11").

Some limitations apply with this option. Please contact your nearest SCREEN sales representative for further details.

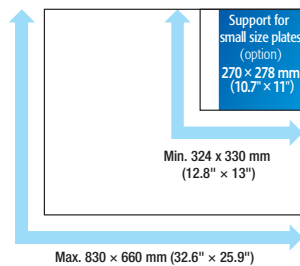

Constant checking of CtP status from a remote location

Remote monitoring system

Remote monitoring allows users to keep an eye on CtP operating conditions and output history from a remote location, using a web browser or e-mail. E-mails can also be sent automatically to the service center and entered into a database for use in maintenance, repairs, and periodic inspections, ensuring that the CtP recorder is in optimal operating condition at all times*.

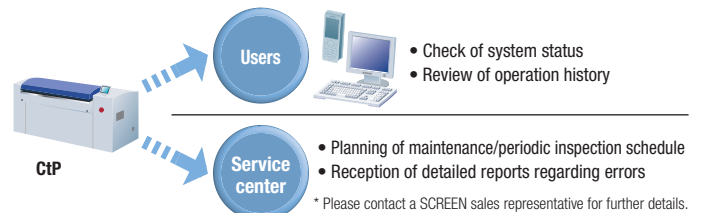

* Please contact a SCREEN sales representative for further details.

Advanced EQUIOS workflow system

Linking the PlateRite 4600 series with EQUIOS enables non-stop automatic processing with minimal errors, waste or downtime. This simplified operation improves the efficiency of CtP processing and helps the entire system to achieve the maximum possible productivity.

Extremely user-friendly continuous operation

- In-RIP imposition allows the creation of highly efficient workflows.
- The availability of CIP4-compatible fold catalogs improves the speed and reliability of imposition design.

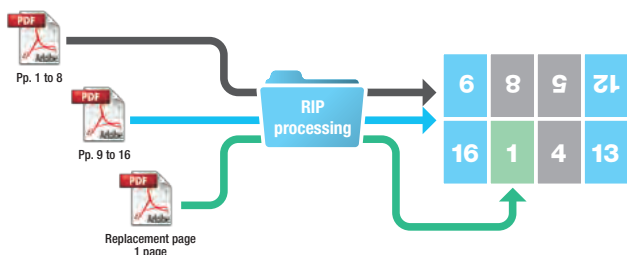

Latest Adobe PDF print engine

- Comprehensive advance verification ensures reliable output results.
- Use of the latest engine enables extremely rapid computation.

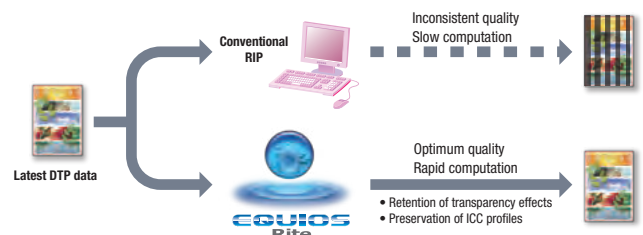

Space requirements

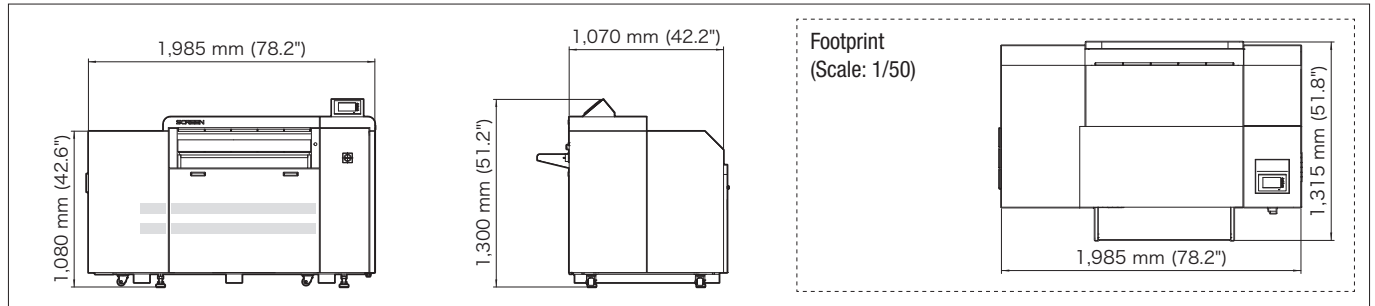

PlateRite 4600 specifications

Product name	PlateRite 4600Z	PlateRite 4600S	PlateRite 4600E
Recording system	External drum		
Light source	64-channel fiber laser diodes	32-channel fiber laser diodes	16-channel fiber laser diodes
Plate sizes	Maximum 830 × 660 mm (32.6" × 25.9"); Minimum 324 × 330 mm (12.8" × 13") (Compatible with a 270 × 278 mm [10.7" × 11"] minimum plate size as an option)*1		
Exposure size	830 × 636 mm (32.6" × 25") (12 mm [0.5"] leading/trailing edge clamps), compatible with a maximum exposure size of 830 × 644 mm (32.6" × 25.3") (8 mm [0.4"] leading/trailing edge clamps) as an option*1		
Media	Thermal aluminum plate		
Media thickness	0.15 to 0.3 mm (5.9 to 11.8 mil)		
Resolutions	1,200*2 / 2,400/2,438/2,540 dpi		
Repeatability	±5 microns*3		
Productivity	33 plates/hr at 2,400 dpi (724 × 615 mm / 28.5" × 24.2")*4	21 plates/hr at 2,400 dpi (724 × 615 mm / 28.5" × 24.2")*4	11 plates/hr at 2,400 dpi (724 × 615 mm / 28.5" × 24.2")*4
Interface	Gigabit Ethernet		
Plate transport	Manual supply / manual discharge (standard), manual supply / automatic discharge (option), fully automatic (option)		
Punch systems	SCREEN, Heidelberg, Heidelberg W, Protocol, Komori and others		
Dimensions (W × D × H)	1,985 × 1,315 × 1,300 mm (78.2" × 51.8" × 51.2") (including internal blower unit and feed tray)		
Weight	830 kg (1,826 lb) (including internal blower unit and feed tray)		
Power requirements	Single phase 200 to 240 V, 15 A, 3.6 kW (including internal blower unit and autoloader)		
Environment	Recommended: 21 to 25°C (69.8 to 77°F) Required: 18 to 26°C (64.4 to 78.8°F) Relative humidity: 40 to 70% (no condensation)		
Options	SA-L4600 single-cassette autoloader, MA-L4600 multi-cassette autoloader, plate transport system (built-in bridge), connection kit for SA-L/MA-L4300II, signal tower, air filter unit (AF-180N)		

*1. Some limitations apply. Please contact your nearest SCREEN sales representative for further details.

*2. 1,200 dpi uses 2,400 dpi double dots.

*3. Over four consecutive exposures on one plate at 35°C (95°F) and 60% relative humidity.

*4. Productivity may vary depending upon media sensitivity.

Autoloader specifications (SA-L4600 single-cassette autoloader, MA-L4600 multi-cassette autoloader)

Product name	SA-L4600	MA-L4600
Plate transport	Fully-automatic (automatic interleaf paper removal)	
Total cassette capacity	100 plates	300 plates
No. of cassettes	1	3
Dimensions (W × D × H)	1,395 × 1,735 × 1,027 mm (55" × 68.4" × 40.5")	2,590 × 1,735 × 1,027 mm (102" × 68.4" × 40.5")
Weight	Approx. 340 kg (748 lb)	Approx. 765 kg (1,683 lb)
Power requirements	Supplied by main unit	
Environment	Recommended: 21 to 25°C (69.8 to 77°F) Required: 18 to 26°C (64.4 to 78.8°F) Relative humidity: 40 to 70% (no condensation)	
Standard accessories	Interleaf paper disposal box, carrier-type cassette	Interleaf paper disposal box
Options	Additional carrier-type cassettes	—

For more information, please visit our Web site.
Various product videos can be viewed on the site.
www.screen.co.jp/ctp_no1



SCREEN Graphic and Precision Solutions Co., Ltd.

HEAD OFFICE

• Tenjinkita-machi 1-1, Teranouchi-agaru 4-chome, Horikawa-dori, Kamigyo-ku, Kyoto 602-8585, Japan / Tel: +81-75-414-7610

SCREEN GP Americas, LLC

• 5110 Tollview Drive, Rolling Meadows, IL 60008, U.S.A. / Tel: +1-847-870-7400 / Fax: +1-847-870-0149 www.screenusa.com

SCREEN GP Europe B.V.

• Bouwerij 46, 1185XX Amstelveen, The Netherlands / Tel: +31-20-456-78-00 / Fax: +31-20-456-78-05 www.screeneurope.com

U.K. office / Tel: +44-1582-72-5400 / Fax: +44-1582-72-5405

SCREEN HD Singapore PTE. Ltd.

• 29, Kaki Bukit View, Kaki Bukit Techpark II, Singapore 415963 / Tel: +65-67493833 / Fax: +65-67499010 www.screenp.com.sg

Indian Liaison office / Tel: +91 22-6673-5088 / Fax: +91 22-6673-5087

SCREEN GP China Co., Ltd.

• Room 2001 - 2003, 20/F Cable TV tower 9 Hei Shing Road Tsuen Wan, N.T. Hong Kong / Tel: +852-2953-0038 / Fax: +852-2755-8683 www.screenchina.com

Shanghai office / Tel: +86-21-3126-5122 / Fax: +86-21-5218-2199

Beijing office / Tel: +86-10-6708-9271, 9272, 9273 / Fax: +86-10-6708-9395

Guangzhou office / Tel: +86-20-3891-1112 / Fax: +86-20-3891-1036

SCREEN GP Taiwan Co., Ltd.

• 4th Floor, No. 126-1, Min-tsu West Road, Taipei, Taiwan R.O.C. / Tel: +886-2-25862711 / Fax: +886-2-25914367

SCREEN HD Korea Co., Ltd.

• Nonsaei Bongrae B/D 10FL, Bongrae-Dong, Joong-Gu, Seoul, 100-161, Korea / Tel: +82-2-727-0860 / Fax: +82-2-727-0876 www.screen-korea.com

SCREEN GP Australia PTY., Ltd.

• Suite 11, 2 Edden Park Drive, Macquarie Park, NSW 2133, Australia / Tel: +61-2-9016-3400 / Fax: +61-2-9016-3425 www.screenaustralia.com.au

Internet web site : www.screen.co.jp/gp

www.screenusa.com

www.screeneurope.com

• This brochure was made using SPEKTA 2 screening.

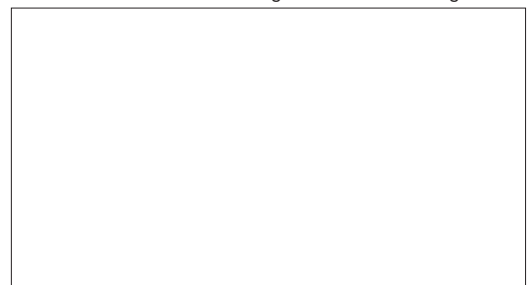

We reserve the right to alter product design and specifications without prior notice.

No.205-173E Printed in Japan 05-16 060PSI(R1-1)