

KOMATSU

HB215LC-3

Hybrid

EPA Tier 4 Final Engine
Australia and New Zealand Specifications



Overseas model shown.

Hybrid hydraulic
Excavator

NET Horsepower
110 kW @ 2000 rpm
148 HP @ 2000 rpm

Operating weight
23,471 kg – 23,726 kg

Bucket capacity
0.50–1.20 m³

HB215LC-3

NET Horsepower

**110 kW @ 2000rpm
148 HP @ 2000rpm**

Operating weight

23,471–23,726 kg

Bucket capacity

0.50 – 1.20 m³



High production and low fuel consumption

A powerful Komatsu SAA4D107E-3 engine provides a net output of 110 kW 148 HP. This engine is EPA Tier 4 Final emissions certified.

Temperature controlled fan clutch helps improve fuel efficiency and lower sound levels.

An ultra low idle speed and Komatsu hybrid technology work together to help reduce fuel consumption up to 35%.

DEF (Diesel Exhaust Fluid) tank and pump are separated and located for easy service access. DEF system components are heated for operation in cold temperatures.

Variable Geometry Turbocharger (VGT) uses a hydraulic actuator to provide optimum air flow under all speed and load conditions.

Komatsu Diesel Particulate Filter (KDPF) and Selective Catalytic Reduction (SCR) system reduce particulate matter and NOx while providing automatic regeneration that does not interfere with daily operation.

Large displacement high efficiency pumps

helps provide high flow output at lower engine speed, improving efficiency.

Electrically driven swing motor powered by a Komatsu Ultra Capacitor provides high swing power and speed allowing oil flow, which would be used for swing, to be dedicated to the boom, arm, and bucket functions.

Engine driven generator charges the Komatsu ultra capacitor when required and can function as an electric motor to assist in engine response from ultra low idle.

Six working modes are designed to match engine speed, pump delivery and system pressure to a wide variety of applications.

Komatsu's Closed Centre Load Sensing (CLSS) hydraulic system provides quick response and smooth operation to maximise productivity.

Large LCD colour monitor:

- 7" high resolution display
- Provides "Ecology Guidance" for fuel efficient operation
- Enhanced attachment control

Peace of mind

The hybrid power train is covered by a 48 month / 10,000 hour warranty.

KomVision is a new rear view monitoring system display has a rear view camera image that is continuously displayed together with the gauges and important vehicle information. This enables the operator to carry out work while easily checking the surrounding area.



The Komtrax® telematics system is standard on Komatsu equipment with no subscription-fee's throughout the life of the machine. Using the latest wireless technology, Komtrax® transmits valuable information such as location, utilisation, and maintenance records to a PC or smartphone app. Custom machine reports are provided for identifying machine efficiency and operating trends.

Komtrax® also provides advanced machine troubleshooting capabilities by continuously monitoring machine health.

Enhanced working environment

- High back, heated air suspension operator seat with adjustable armrests
- Climate control system automatically adjusts heating and cooling for comfortable operator environment.
- Integrated ROPS cab design (ISO 12117-2)
- Cab meets ISO Level 1 Operator Protective Guard (OPG) top guard (ISO 10262)
- Aux jack and (2) 12V power outlets

Komatsu designed and manufactured components

Handrails (standard) located on the machine upper structure provide a convenient work area in front of the engine.

Battery disconnect switch allows a technician to disconnect the power supply before servicing the machine.

Heavy duty boom design with large one piece castings provide increased strength and durability.

Komatsu Auto Idle and Auto Idle Shutdown systems helps reduce nonproductive engine idle time and reduces operating costs.

Operator Identification system scan track key machine operation and application information for up to 100 individual ID codes and provide information through Komtrax®.



Performance features

Komatsu's emission regulations-compliant engine

regulations require the reduction of NO_x emissions to one tenth or below from the preceding regulations. In addition to refining the Tier 4 Interim technologies, Komatsu has developed a new Selective Catalytic Reduction (SCR) device in-house.

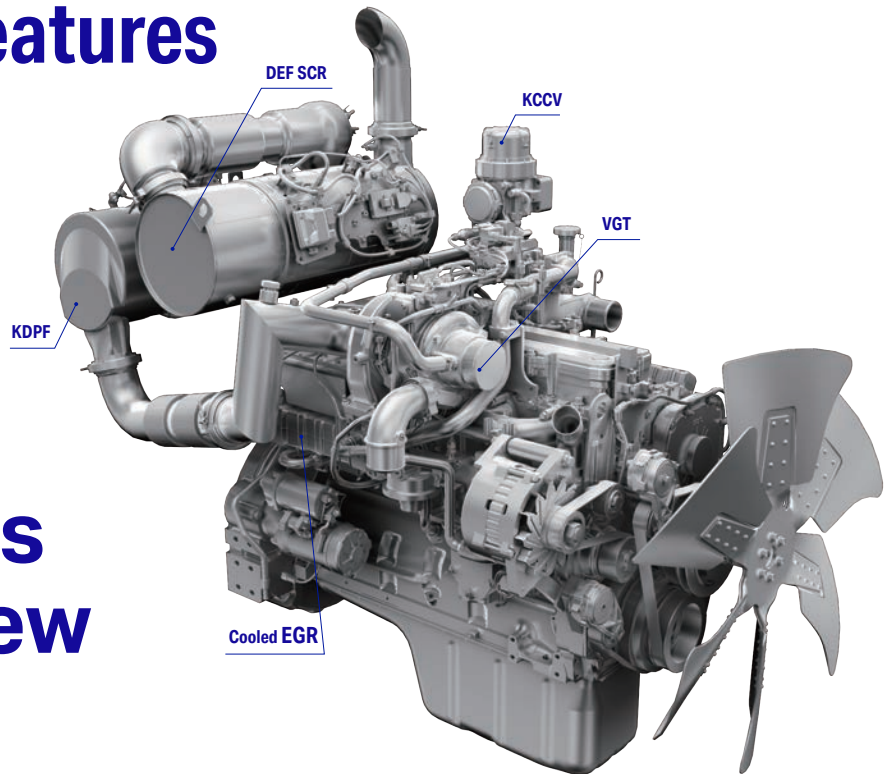

Technologies applied to new engine

Heavy-duty aftertreatment system

This new system combines a Komatsu Diesel Particulate Filter (KDPF) and Selective Catalytic Reduction (SCR). The SCR NO_x reduction system injects the correct amount of Diesel Exhaust Fluid (DEF) at the proper rate, thereby decomposing NO_x into non-toxic water vapor (H₂O) and nitrogen gas (N₂).

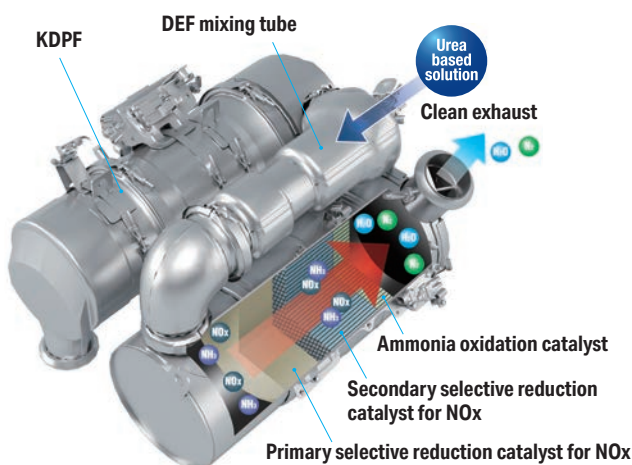

Advanced electronic control system

the electronic control system performs high-speed processing of all signals from sensors installed in the vehicle providing total control of equipment in all conditions of use.

Engine condition information is displayed via an on-board network to the monitor inside the cab, providing necessary information to the operator. Additionally, managing the information via Komtrax® helps customers keep up with required maintenance.

Heavy-duty cooled Exhaust Gas Recirculation (EGR) system

The system recirculates a portion of exhaust gas into the air intake and lowers combustion temperatures, thereby reducing NO_x emissions. EGR gas flow has been decreased for Tier 4 Final with the addition of SCR technology. The system achieves a dynamic reduction of NO_x, while helping reduce fuel consumption below Tier 4 Interim levels.

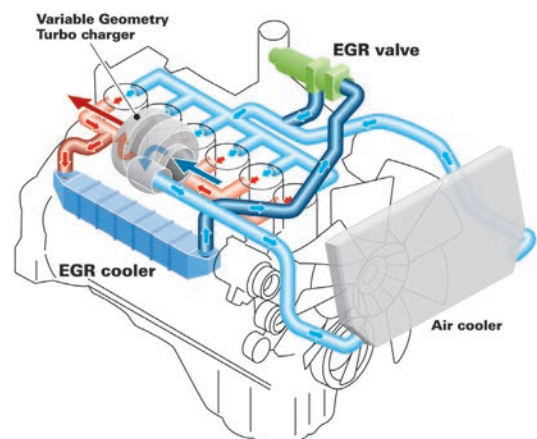

Variable Geometry Turbocharger (VGT) system

The VGT system features proven Komatsu design hydraulic technology for variable control of air-flow and supplies optimal air according to load conditions. The upgraded version provides better exhaust temperature management.

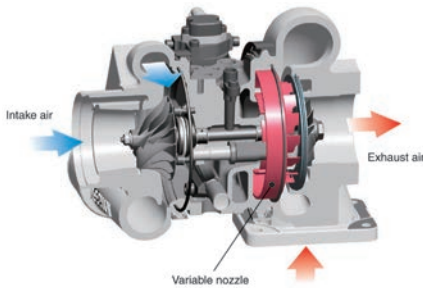

Komatsu auto idle

Komatsu auto idle automatically reduces engine RPM after 4 seconds of work equipment inactivity to reduce unnecessary fuel consumption and exhaust emissions.

Komatsu auto idle shutdown

Komatsu auto idle shutdown automatically shuts the engine down after idling for a set period of time to reduce unnecessary fuel consumption and exhaust emissions. The amount of time before the engine is shutdown can be easily programmed from 5 to 60 minutes.

Working Modes Selectable

Ecology Guidance

Ecology Gauge & Fuel Consumption Gauge

Idling Caution

Increased Work Efficiency

Large digging force

With the one-touch Power Max. function, digging force is increased for 8.5 seconds of operation.

Maximum arm crowd force (ISO 6015)

101 kN(10.3t) ➔ 108 kN(11.0t) **7%_{up}**
(with Power Max.)

Maximum bucket digging force (ISO 6015)

138 kN(14.1t) ➔ 149 kN(15.2t) **8%_{up}**
(with Power Max.)

Measured with power max. function, 3185mm arm and ISO 6015 rating



HB215LC-3

Drawbar pull Drawer pull

The Komatsu designed final drives and undercarriage provide high drawbar pull for good maneuverability and performance when working on adverse grades or soft ground.



Grease sealed track

The HB215LC-3 uses grease sealed tracks for extended undercarriage life.

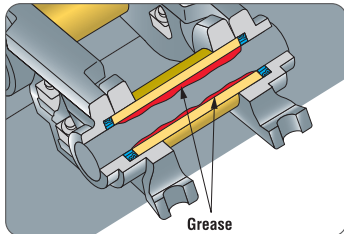

Large displacement high efficiency pump

Large displacement hydraulic implement pumps provide high flow output at lower engine RPM as well as operation at the most efficient engine speed.



Working mode selection

The HB365LC-3 excavator is equipped with six working modes (P, E, L, B, ATT/P and ATT/E). Power Mode provides improved hydraulic power and faster cycle times for improved performance in demanding applications. Each mode is designed to match engine speed, pump flow, and system pressure to the application. The HB215LC-3 features an attachment mode (ATT/E) that allows operators to run attachments while in Economy mode.

Working mode	Application	Advantage
P	Power mode	Maximum production, power & multifunction
E	Economy mode	Good cycle times with reduced fuel consumption
L	Lifting mode / Fine control	Increased lifting power & fine control
B	Breaker mode	One way flow for hydraulic breaker operation
ATT / P	Attachment power mode	Two way flow with maximum power
ATT / E	Attachment economy mode	Two way flow with most efficient fuel economy

- P** Performance priority
P mode
- E** Fuel savings priority
E mode
- L** Lifting operation
L mode
- B** One way flow breaker operation
B mode
- ATT/P** Two way flow attachment – Power
ATT/P mode
- ATT/E** Two way flow attachment – Economy
ATT/E mode

High rigidity work equipment

booms and arms are constructed with thick plates of high tensile strength steel. In addition, these structures are designed with large cross sectional areas and large one piece castings in the boom foot, the boom tip, and the arm tip. The result is work equipment that exhibits long term durability and high resistance to bending and torsional stress. A standard HD boom design provides increased strength and reliability.



Hybrid technology

Komatsu hybrid technology

Reliable and durable hybrid components developed and manufactured by Komatsu

The unique Komatsu hybrid system uses an electric swing motor-generator to capture and regenerate swing energy as the upper structure slows down and converts it into electric energy. The regenerated energy is stored in a high performance capacitor and used to provide power to the swing motor when swinging. The capacitor also powers an engine mounted motor-generator to assist the engine when it needs to accelerate. The hybrid system reduces fuel consumption significantly. Most components of the system are developed and manufactured by Komatsu.

*: Except capacitor cells

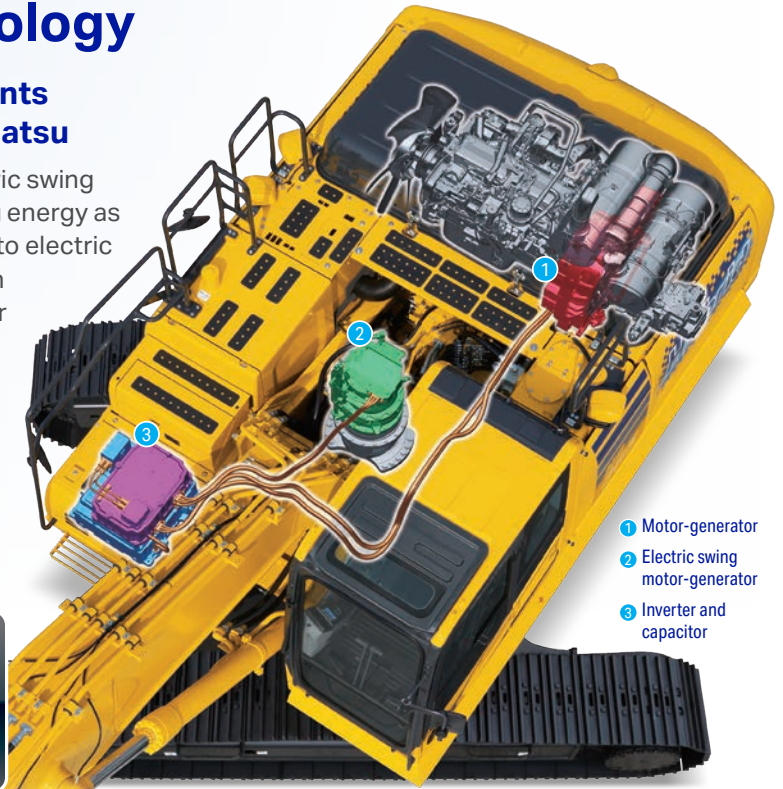

- ① Motor-generator
- ② Electric swing motor-generator
- ③ Inverter and capacitor

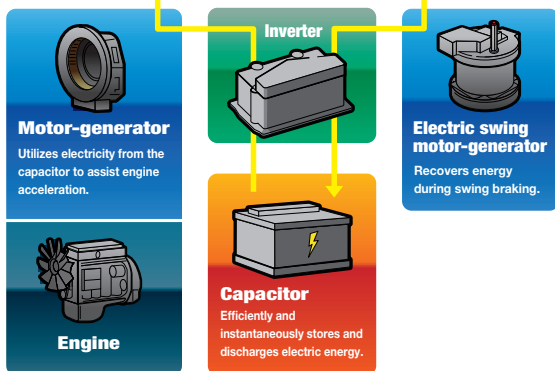
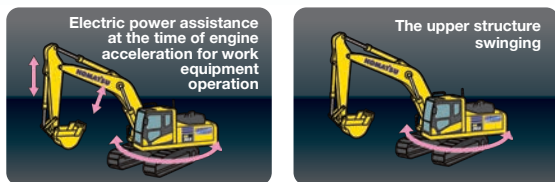

Ultra capacitor assembly

the ultra-capacitor assembly includes an inverter that switches the AC electricity from the generator motor and swing motor into DC electricity for storage in the capacitor. Since capacitors require migration of electrons and ions for charging and discharging, they can transfer power much faster than batteries, which use chemical reactions to produce electricity. The industrial quality designed inverter and capacitor provide long service life, and require no periodic maintenance.

Motor-generator

A motor-generator is positioned between the engine and hydraulic pumps to assist in rapid engine response from ultra low idle when required. The generator produces electric power and charges the capacitor when required.

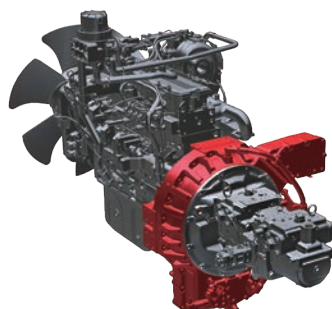

Electric swing motor-generator

An electric swing motor-generator recovers energy during swing braking. The motor-generator also accelerates the swing of the upper structure more efficiently than a conventional hydraulic motor and provides excellent swing performance. Dedicated lubrication and cooling systems are used for reliability and durability.



Hybrid technology

Easy-to-understand hybrid operation monitor screen

Energy management screen

The hybrid system operating status can be easily displayed on the monitor to show how energy is flowing through the system components which include capacitor charging/discharging and engine assist by the generator/motor.

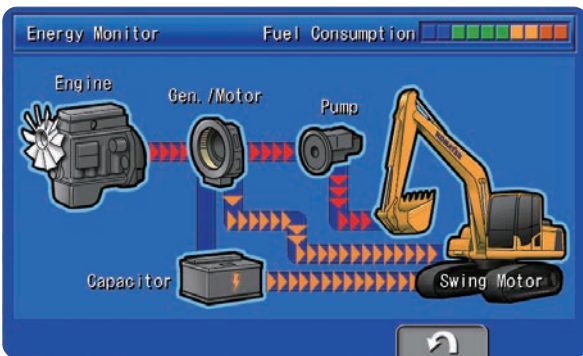

Hybrid system temperature gauge

A hybrid system temperature gauge is included in the main display screen along with engine and hydraulic temperature gauges. It displays the hybrid system temperature and allows the operator to monitor the system status at a glance.



Hybrid system temperature gauge

The advanced technology of the Komatsu Hybrid System, combined with the innovative design of the Tier 4 Final engine and the integration of a comprehensive vehicle control system, results in an additional reduction in fuel consumption.

Fuel consumption

Reduced by up to 35%
(vs PC210LC-11)

Based on typical work pattern collected via Komtrax®.

Viscous Fan Clutch

A temperature controlled viscous fan clutch improves engine efficiency and reduces engine power requirements when operating in cooler temperatures.



General features

ROPS cab structure

ROPS Cab (ISO 12117-2)

The machine is equipped with a ROPS cab that conforms to ISO 12117-2 for excavators as standard equipment. It also satisfies the requirements for Level 1 Operator Protective Guard (OPG) and top guard (ISO 10262).



Low vibration with viscous cab mounts

The HB215LC-3 uses viscous mounts for the cab that incorporate a longer stroke and the addition of a spring. The cab damper mounting combined with a high rigidity deck reduces vibration at the operator's seat.

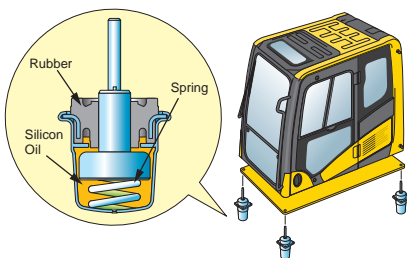

General features

Secondary engine shut down switch at base of seat to shutdown the engine.



- Lock lever
- Retractable seat belt
- Tempered & tinted glass
- Large cab entrance step
- Left and right side handrails

Seat belt caution indicator



- Large mirrors
- Slip-resistant plates
- Thermal and fan guards
- Pump/engine compartment partition
- Travel alarm



Working environment



Comfortable working space

Wide spacious cab

Wide spacious cab includes seat with reclining backrest. The seat height and position are easily adjusted using a pull-up lever. You can set the appropriate operational posture of armrest together with the console. Reclining the seat further enables you to place it into the fully flat state with the headrest attached.

Arm rest with simple height adjustment

A knob and plunger on the armrests allows easy height adjustment without the use of tools.



Auxiliary input jack

Connecting a regular audio device to the auxiliary jack allows the operator to hear the sound from the speakers.



Low vibration with cab damper mounting

Automatic climate control

Pressurised cab with cab air filter

Standard equipment

Sliding window glass (left side)



AM / FM stereo radio and ashtray



Defroster (conforms to the ISO standard)



One-touch storable front window lower glass



Remote intermittent wiper with windshield washer

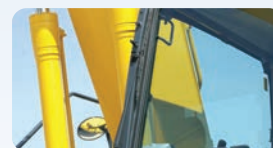

Magazine box and cup holder



Large high resolution LCD monitor



New monitor panel interface design

An updated large high resolution LCD colour monitor enables accurate and smooth work. The interface has been redesigned to display key machine information in a new user friendly interface. A rear view camera and a DEF level gauge display have been added to the default main screen. The interface has a function that enables the main screen mode to be switched, thus enabling the optimum screen information for the particular work situation to be displayed.

Indicators

- | | |
|--|-------------------------------|
| 1 Auto Deceleration Indicator | 9 DEF Level Gauge |
| 2 Working mode | 10 Service Meter |
| 3 Travel speed | 11 Fuel Consumption Meter |
| 4 Ecology Display | 12 Function Switch Indicators |
| 5 Camera Display | 13 Function Switches |
| 6 Engine Coolant Temperature Display | 14 Camera Direction |
| 7 Hydraulic System Temperature Display | 15 DEF Level Caution Lamp |
| 8 Fuel Gauge | |

Basic operation switches

- | | |
|--------------------|-----------------------------|
| 1 Auto Decelerator | 5 Wiper |
| 2 Working Mode | 6 Window washer |
| 3 Travel Speed | 7 Climate Control Selection |
| 4 Buzzer Cancel | |

Visual user menu

Pressing the F6 key on the main screen displays the user menu screen. The menus are grouped for each function, and use easy-to-understand icons which enable the machine to be operated easily.



- | | |
|---------------------------------------|-------------------|
| 1 Energy saving guidance | 4 SCR information |
| 2 Machine settings | 5 Maintenance |
| 3 Aftertreatment devices regeneration | 6 Monitor setting |
| | 7 Message check |

Switchable display modes

The main screen display mode can be changed by pressing the F3 key. Screen images shown are for the standard rear view camera.

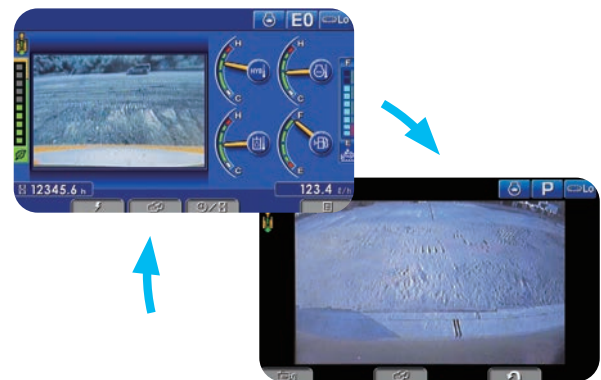

Working environment

Support efficiency improvement

Ecology guidance

While the machine is operating, ecology guidance pops up on the monitor screen to notify the operator of the status of the machine in real time.

Ecology gauge and fuel consumption gauge

The monitor screen is provided with an ecology gauge and also a fuel consumption gauge which is displayed continuously. In addition, the operator can set any desired target value of fuel consumption (within the range of the green display), enabling the machine to be operated with better fuel economy.



Operation record, fuel consumption history, and ecology guidance record

The ecology guidance menu enables the operator to check the operation record, fuel consumption history and ecology guidance record from the ecology guidance menu, using a single touch, thus assisting operators with reducing total fuel consumption.



Operation record



Fuel consumption history

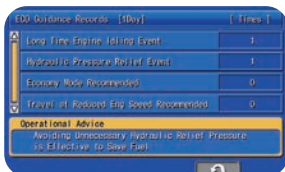

Ecology guidance record

KomVision

Images from 4 camera's are combined to display a "birds eye" view of the area around the machine for improved operator awareness. A second display with selectable individual camera views of the left, rear, and right sides is easily changed using the F4 button. A red line continuously shows where the counterweight will be during swinging and a camera icon indicates which camera is being displayed on individual camera display screen.



Maintenance features



Large capacity air cleaner

The larger air cleaner can extend air cleaner life during long-term operation and helps prevent early clogging, and resulting power loss. A radial seal design is used for reliability.



Engine access

Large rear opening hood provides excellent maintenance and service access to key engine components.



Fuel filters

Large high-efficiency fuel filter and pre-filter with water separator removes contaminants from fuel for improved fuel injection system life.



High efficiency fuel filter Fuel pre-filter (with water separator)

Easy access to engine oil filter and fuel drain valve

Engine oil filter and fuel drain valve are remote mounted to improve accessibility.



Battery isolation switch

A standard battery isolation switch allows a technician to disconnect the power supply and lock out before servicing the machine.



Air conditioner filter

The air conditioner filter can be removed and installed without the use of tools for easy filter maintenance.

Washable cab floormat

Sloping track frame

Long-life oils, filters

Engine oil & Engine oil filter	every 500 hours
Hydraulic oil	every 5000 hours
Hydraulic oil filter	every 1000 hours

DT-type connectors

Sealed DT-type electrical connectors provide high reliability, water and dust resistance.

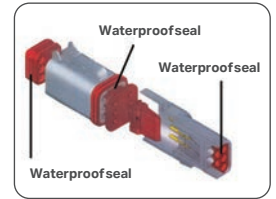

Diesel Exhaust Fluid (DEF) tank

A large tank volume extends operating time before refilling and is installed on the right front platform for easy access. DEF tank and pump are separated for improved service access.



Maintenance information

"Maintenance time caution lamp" display

When the remaining time to maintenance becomes less than 30 hours*, a maintenance time monitor appears. Pressing the F6 key switches the monitor to the maintenance screen.

*: The setting can be changed within the range between 10 and 200 hours.



Maintenance screen

Manual Stationary Regeneration

Under most conditions, active regeneration will occur automatically with no effect on machine operation. In case the operator needs to disable active regeneration or initiate a manual stationary regeneration, this can be easily accomplished through the monitor panel. A soot level indicator is displayed to show how much soot is trapped in the KDPF.

Soot level indicator



Aftertreatment device regeneration screen

Supports the DEF level and refill timing

The DEF level gauge is displayed continuously on the right side of the monitor screen. In addition, when DEF level is low, DEF low level guidance messages appear in pop up displays to inform the operator in real time.



DEF level gauge

DEF low level guidance

Komtrax® equipment monitoring

Get the whole story with



What

- Komtrax® is Komatsu's remote equipment monitoring and management system
- Komtrax® continuously monitors and records machine health and operational data
- Information such as fuel consumption, utilisation, and a detailed history lowering owning and operating cost

Who

- Komtrax® is standard equipment on all Komatsu construction products

When

- Know when your machines are running or idling and make decisions that will improve your fleet utilisation
- Detailed movement records ensure you know when and where your equipment is moved
- Up to date records allow you to know when maintenance is due and help you plan for future maintenance needs

Where

- Komtrax® data can be accessed virtually anywhere through your computer, the web or your smart phone
- Automatic alerts keep fleet managers up to date on the latest machine notifications

Why

- Knowledge is power – make informed decisions to manage your fleet better
- Knowing your idle time and fuel consumption will help maximise your machine efficiency
- Take control of your equipment – any time, anywhere.



For construction and compact equipment.

Specifications

Engine

Model	SAA4D107E-3*
Type	Water-cooled, 4-cycle, direct injection
Aspiration	Turbocharged, aftercooled, cooled EGR
Number of cylinders	4
Bore	107 mm
Stroke	124 mm
Piston displacement	4.46 ltr
Horsepower	
SAE J1995	Gross 110 kW 148 HP
ISO 9249 / SAE J1349	Net 110 kW 148 HP
Hydraulic fan at maximum speed	Net 103 kW 138 HP
Rated rpm	2000 rpm
Fan drive method for radiator cooling	Mechanical with viscous fan clutch
Governor	All-speed control, electronic

Hydraulics

Type	HydraMind (Hydraulic Mechanical Intelligence) system, closed-center system with load sensing valves and pressure compensated valves	
Number of selectable working modes	6	
Main pump:		
Type	Variable displacement piston type	
Pumps for	Boom, arm, bucket, and travel circuits	
Maximum flow	452 ltr/min	
Supply for control circuit	Self reducing valve	
Hydraulic motors:		
Travel	2 x axial piston motors with parking brake	
Swing	1 x axial piston motor with swing holding brake	
Relief valve setting:		
Implement circuits	37.3 MPa 380 kg/cm ² 5,409 psi	
Travel circuit	37.3 MPa 380 kg/cm ² 5,409 psi	
Pilot circuit	3.2 MPa 33 kg/cm ² 470 psi	
Hydraulic cylinders: (Number of cylinders – bore x stroke x rod diameter)		
Boom	2-130 mm x 1334 mm x 90 mm	
Arm	1-135 mm x 1490 mm x 95 mm	
Bucket	for 3200mm and 4000mm Arms 1-115 mm x 1120 mm x 80 mm	

Drives and brakes

Steering control	Two lever with pedals	
Drive method	Fully hydrostatic	
Maximum drawbar pull	202 kN 20570 kg	
Gradeability	70%, 35°	
Maximum travel speed (auto shift):		
High	5.5 km/h	Mid 4.1 km/h
		Low 3.2 km/h
Service brake	Hydraulic lock	
Parking brake	Mechanical disc brake	

Swing system

Drive method	Electric drive
Swing reduction	planetary gear
Swing circle lubrication	Grease-bathed
Service brake	Electric brake
Holding brake / swing lock	Mechanical disc brake
Swing speed	12.4 rpm
Swing torque	7040 kg•m

Undercarriage

Centre frame	X-frame
Track frame	Box-section
Track type	Sealed
Track adjuster	Hydraulic
Number of shoes (each side)	49
Number of carrier rollers (each side)	2
Number of track rollers (each side)	9

Coolant and lubricant capacity (refilling)

Fuel tank	400 ltr
Coolant (engine)	28.0 ltr
Ultra capacitor cooling system	5.0 ltr
Engine	18.0 ltr
Final drive, each side	5.0 ltr
Swing drive	6.5 ltr
Swing motor - generator	6.5 ltr
Motor-generator	1.6 ltr
Hydraulic tank	132 ltr
DEF tank	23.1 ltr

Sound performance

Exterior – ISO 6395	99 dB(A)
Operator – ISO 6396	68 dB(A)

Operating Weight (approximate)

Operating Weight including 5700mm one-piece HD boom, 2925mm arm, 600mm track shoes, KGA STD hitch, KGA 600mm GP bucket (empty), rated capacity of lubricants & coolant with an operator.

Triple-grouser	Operating weight	Ground pressure (ISO 16754)
600mm	23,486 kg	0.50 kg/cm ² 7.11 psi

Component weights

Arm including bucket cylinder and linkage	
2925 mm arm assembly	1182 kg
One piece HD boom including arm cylinder	
5700 mm boom assembly	1755 kg
Boom cylinders x 2	210 kg
Counterweight	3580 kg
600mm GP KGA bucket	595 kg
Plus one piped boom and arm	Add 100 kg

Dimensions

	Arm Length	2925mm
A	Overall length	9705 mm
B	Length on ground (transport)	5000 mm
C	Overall height (to top of boom)*	2970 mm
D	Overall width	3080 mm
E	Overall height (to top of cab)*	3045 mm
F	Overall height (to top of handrail)*	3135mm
G	Ground clearance, counterweight	1085 mm
H	Ground clearance, minimum	440 mm
I	Tail swing radius	3020mm
J	Track length on ground	3655mm
K	Track length	4450 mm
L	Track gauge	2380 mm
M	Width of crawler	3080 mm
N	Shoe width	700 mm
O	Grouser height	26 mm
P	Machine height to top of engine cover	2250 mm
Q	Machine upper width **	2850 mm
R	Distance, swing center to rear end	2990 mm

* Including grouser height

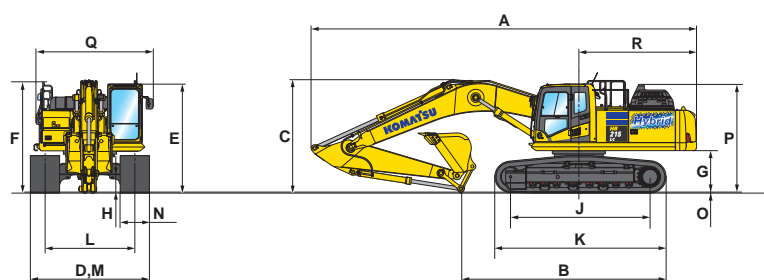
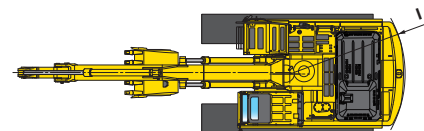

Standard equipment

- 3 speed travel with auto shift
- Alternator, 24 V/90 A
- AM/FM radio with AUX input
- Arm holding valve
- Auto idle
- Auto idle shut down programmable
- Automatic climate control/air conditioner/ heater/ defroster
- Automatic engine warm-up system
- Auxiliary input (3.5 mm jack)
- Batteries, large capacity (2 x 12V)
- Battery master disconnect switch
- Bolt-on top guard, OPG Level 2
- Boom holding valve
- Carbody swivel guard
- Carrier roller (2 each side)
- Counterweight, 6320 kg
- Dry type air cleaner, double element
- Electric horn
- Electric swing motor/generator
- Engine mounted motor/generator
- Engine overheat prevention system
- Engine, Komatsu SAA6D114E-6
- Equipment Management Monitoring System (EMMS)
- Fuel pre-filter (10 micron, with water separator)
- Fuel priming pump
- High back air suspension seat with heat
- Hybrid component cooling system
- Hydraulic track adjusters (Each side)
- Komtrax® level 5.0
- KomVision surround camera system
- KomVision birds eye view
- Large high resolution 7" LCD monitor
- Lock lever, work equipment
- Lower front window guard
- Mirrors (RH and LH)
- Operator identification system
- Operator protective top guard (OPG), level 2
- Overload Alarm
- Power maximising system
- Power ports (2) 24V to 12V
- PPC hydraulic control system
- Proportional control handles for auxiliary hydraulics
- Pump/engine compartment partition
- Radiator and oil cooler removable debris screen
- Rear reflector
- Revolving frame deck guards
- Revolving frame under covers
- ROPS cab (ISO 12117-2)
- Seat belt indicator
- Seat belt, retractable, 76 mm 3"
- Secondary engine shut down switch
- Service valve, one additional function
- Service valve, 2nd function provision
- Slip resistant plates
- Starting motor, 24 V/11 kW
- Switch, Turbo Timer
- Thermal and fan guards
- Track roller guides, 2 x each side
- Track roller, 8 each side
- Track shoe, triple grouser, 600 mm
- Travel alarm
- Two-mode setting for boom
- Ultra capacitor with inverter
- Vandal Guard, Provision.
- Viscous fan clutch, temperature controlled
- Working lights, 6 1 x boom, 1 x RHS near steps, 2 x cab front, 1 x cab rear, 1 x counterweight
- Working mode selection system

Optional Factory Equipment

- Full front guard, OPG Level 2 Undercarriage
- Track shoes, triple grouser, 700mm
- Track shoes, triple grouser, 850 mm
- Track roller guards (full length)

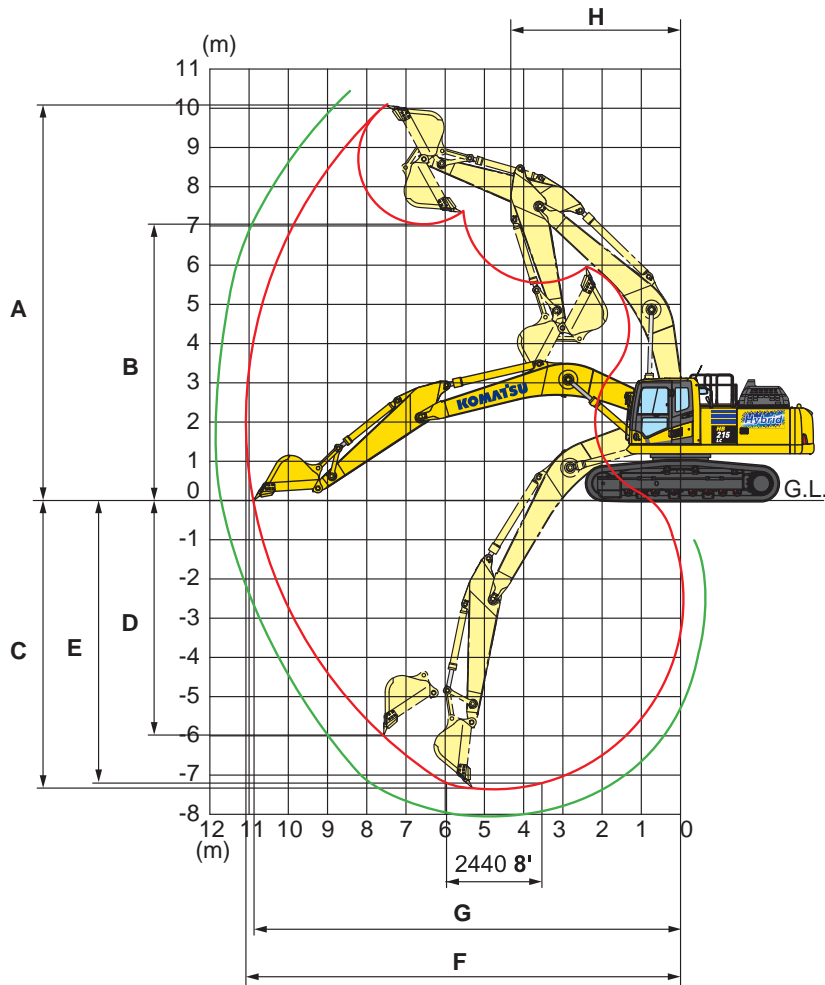

Working range

	Arm Length	2925 mm
A	Maximum digging height	10,000 mm
B	Maximum dumping height	7110 mm
C	Maximum digging depth	6620 mm
D	Maximum vertical wall digging depth	5980 mm
E	Maximum digging depth for 203mm level bottom	6370 mm
F	Maximum digging reach	9875 mm
G	Maximum digging reach at ground level	9700 mm
H	Minimum swing radius	3040mm
SAE rating:		
	Bucket digging force at maximum power	132 kN 13,500 kg
	Arm crowd force at maximum power	103 kN 10,500 kg
ISO rating:		
	Bucket digging force at maximum power	149 kN 15,200 kg
	Arm crowd force at maximum power	108 kN 11,000 kg

Lifting capacity with lifting mode

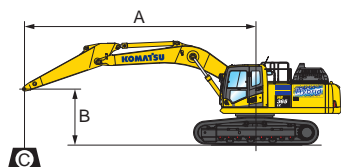

- A Reach from swing centre
- B Bucket hook height
- C Lifting capacity
- Cf Rating over front
- Cs Rating over side
- ⊗ Rating at maximum reach

- Conditions:
- 6500mm one-piece boom
 - Bucket: None
 - Lifting mode: On

Arm: 2925mm Bucket: None Shoes: 700mm Unit: kg

B	A		1.5m		3.0m		4.6m		6.1m		7.6m		⊗ Max	
	Cf	Cs	Cf	Cs	Cf	Cs	Cf	Cs	Cf	Cs	Cf	Cs	Cf	Cs
7.6 m	-	-	-	-	-	-	-	-	-	-	-	-	-	-
6.1 m	-	-	-	-	-	-	*6600	5900	-	-	*3850	3850	-	-
4.6 m	-	-	-	-	*8100	8100	*8250	5800	5250	4150	*3850	3850	-	-
3.0 m	-	-	*12850	12850	*10450	8350	*8350	5600	6000	4100	*3950	3600	-	-
1.5 m	-	-	-	-	*12700	7900	8150	5350	5900	4000	4250	3500	-	-
0 m	-	-	*18550	13330	*13740	9010	10230	6750	7960	5340	7910	5300	-	-
-1.5 m	*7600	*7600	*12050	12050	*12400	7600	7900	5150	5800	3900	5700	3850	-	-
-3.0m	*12350	*12350	*18550	*14450	12450	7650	7950	5150	-	-	6900	4550	-	-
-4.6m	-	-	*15100	14800	*10800	7800	-	-	-	-	*9000	6450	-	-

*Load is limited by hydraulic capacity rather than tipping. Ratings are based on SAE standard No. J1097.
Rated loads do not exceed 87% of hydraulic lift capacity or 75% of tipping load.

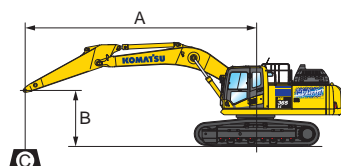

- A Reach from swing centre
- B Bucket hook height
- C Lifting capacity
- Cf Rating over front
- Cs Rating over side
- ⊗ Rating at maximum reach

- Conditions:
- 6500mm one-piece boom
 - Bucket: None
 - Lifting mode: On

Arm: 3185mm Bucket: None Shoes: 850mm Unit: kg

B	A		3.0m		4.6m		6.1m		7.6m		9.1m		⊗ Max	
	Cf	Cs	Cf	Cs	Cf	Cs	Cf	Cs	Cf	Cs	Cf	Cs	Cf	Cs
7.6 m	-	-	-	-	-	-	-	-	-	-	-	-	-	-
6.1 m	-	-	-	-	*6600	5950	-	-	-	-	*3850	3850	-	-
4.6 m	-	-	-	-	*8100	*8100	*7250	5850	*5250	4200	*3850	3850	-	-
3.0 m	-	-	*12850	*12850	*10450	8450	*8350	5650	6100	4100	*3950	3650	-	-
1.5 m	-	-	-	-	*12700	8000	8250	5400	6000	4000	*4250	3550	-	-
0 m	-	-	*7500	*7500	12600	7750	8100	5250	5900	3950	*4250	3600	-	-
-1.5 m	*7600	*7600	*12050	*12050	12550	7650	8000	5200	5850	3900	*5700	3900	-	-
-3.0 m	*12350	*12350	*18550	*14600	12600	7700	8050	5250	-	-	7000	4600	-	-
-4.6 m	-	-	*15100	*14950	10800	7900	-	-	-	-	*9000	6500	-	-

*Load is limited by hydraulic capacity rather than tipping. Ratings are based on ISO standard No. 10567.
Rated loads do not exceed 87% of hydraulic lift capacity or 75% of tipping load.

Notes

Product designs, specifications and/or data in this document are provided for informational purposes only and are not warranties of any kind. Product designs and/or specifications may be changed at any time without notice. The only warranties that apply to sales of products and services are Komatsu's standard written warranties, which will be furnished upon request.

Komatsu and other trademarks and service marks used herein are the property of Komatsu Ltd., Komatsu Australia Pty Ltd., Komatsu New Zealand Limited, Komatsu America Corp., Komatsu Mining Corp., or one of their affiliates, or the respective owners or licensees.

KOMATSU

[komatsu.com.au](https://www.komatsu.com.au)

