



COMETA



GELATO
Gelato
Gelato
Gelato



PASTICCERIA
Pastry
Pâtisserie
Konditorei



PRALINERIA
Praline
Pralinerie
Pralinen



CALDO A SECCO
Dry Heat
Chaud A Sec
Trockene Wärme



BAGNO MARIA
Bain marie
Bain marie
Wasserbad

Cometa ridefinisce il concetto di eleganza e funzionalità. Con il suo design moderno e raffinato, Cometa si integra perfettamente in qualsiasi locale, grazie alla sua struttura compatta (profondità 97 cm). La sua innovativa esposizione flat valorizza ogni prodotto, mettendone in risalto la qualità e creando un'attrazione irresistibile per i clienti.

Cometa redefines the concept of elegance and functionality. With its modern and refined design, Cometa fits seamlessly into any setting, thanks to its compact structure (depth 97 cm). Its innovative flat display enhances each product, highlighting its quality and creating an irresistible attraction for customers.

Cometa redéfinit le concept d'élégance et de fonctionnalité. Avec son design moderne et raffiné, Cometa s'intègre parfaitement dans tout type de lieu, grâce à sa structure compacte (profondeur de 97 cm). Son exposition plate innovante met en valeur chaque produit, soulignant sa qualité et créant une attraction irrésistible pour les clients.

Cometa definiert das Konzept von Eleganz und Funktionalität neu. Mit ihrem modernen und raffinierten Design fügt sich Cometa perfekt in jede Umgebung ein, dank ihrer kompakten Struktur (Tiefe 97 cm). Die innovative flache Präsentation hebt jedes Produkt hervor, betont dessen Qualität und schafft eine unwiderstehliche Anziehungskraft für Kunden.

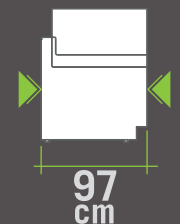



GELATO
Gelato
Gelato
Gelato



PASTICCERIA
Pastry
Pâtisserie
Konditorei



PRALINERIA
Praline
Pralinerie
Pralinen





GELATO
Gelato
Gelato
Gelato



SINGLE AIR FLOW



-16 / -18 °C



7 (35°C - 75%UR)

H=1220

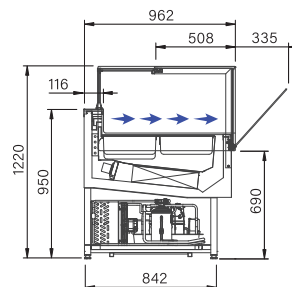
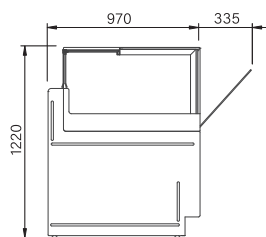

H=1380

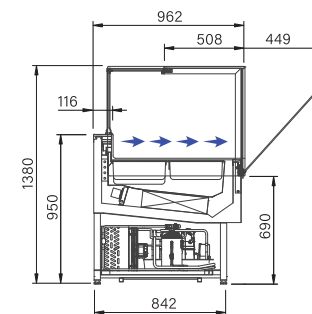
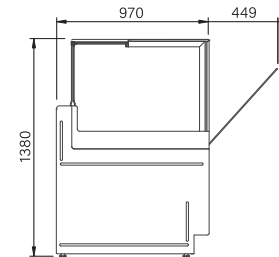

12

Con vaschette **STANDARD**: 5Lt - 7Lt

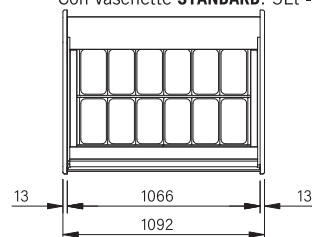

18

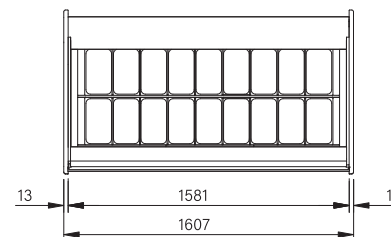

24

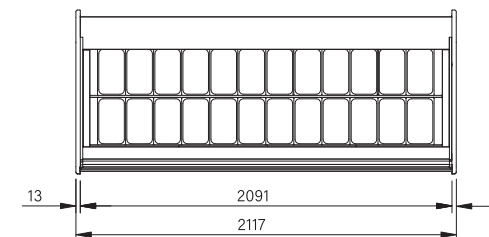

Con vaschette **LARGE**: 5,4Lt - 8 Lt - 11 Lt

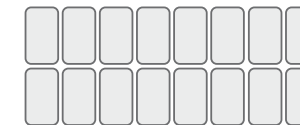

Mod.	12	18	24
DIMENSIONI / DIMENSIONS / TAILLE / GRÖSSE			
Lunghezza / Length / Longueur / Länge [mm]	1092	1607	2117
Profondità / Depth / Profondeur / Tiefe [mm]	970	970	970
Altezza / Height / Hauteur / Höhe [mm]	1220/1380	1220/1380	1220/1380
PESO / WEIGHT / POIDS / GEWICHT [kg]			
	235/245	325/335	390/400
IMBALLO / EMBALLAGE / PACKAGING / VERPACKUNG			
Lunghezza / Length / Longueur / Länge [mm]	1220	1720	2260
Profondità / Depth / Profondeur / Tiefe [mm]	1270	1270	1270
Altezza / Height / Hauteur / Höhe [mm]	1560	1560	1560
POTENZA COMPRESSORE / POWER COMPRESSOR / PUISSANCE COMPRESSEUR / LEISTUNG VERDICHTER			
(Monofase / Single-phase / Monophasé / Einphasig)			
Tensione / Supply / Tension / Spannung [V/Ph/Hz]	230/1/50	230/1/50	230/1/50
Potenza assorbita / Electrical power output / Puissance absorbée / Absorbierte Leistung [kW]	1,51	2,08	2,5
Sbrinamento / In Defrost / Dégivrage / Zeitgesteuerte [kW]	2,15	3,53	3,8
(Trifase / Three-phase / Triphasé / Dreiphasig)			
Tensione / Supply / Tension / Spannung [V/Ph/Hz]	400/3/50	400/3/50	400/3/50
Potenza assorbita / Electrical power output / Puissance absorbée / Absorbierte Leistung [kW]	1,3	1,97	2,8
Sbrinamento / In Defrost / Dégivrage / Zeitgesteuerte [kW]	2,52	3,87	5,1





PASTICCERIA
Pastry
Pâtisserie
Konditorei



PRALINERIA
Praline
Pralinerie
Pralinen

H=1220

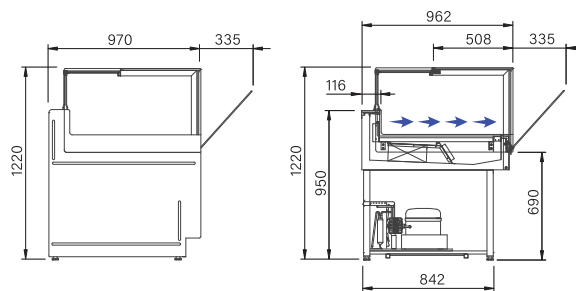

H=1380

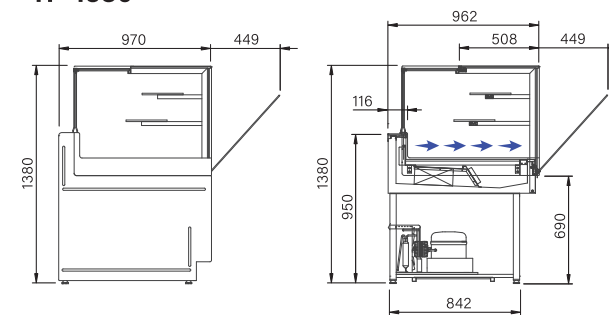

110

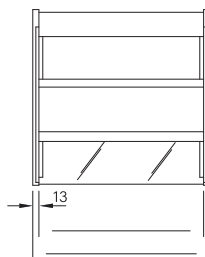

160

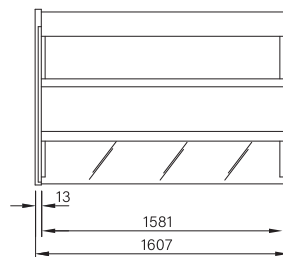

210

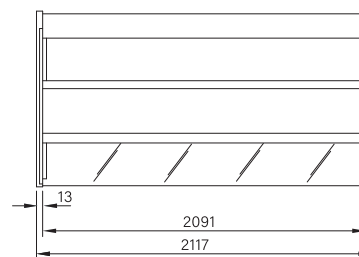

90° DX - SX

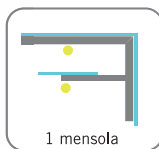
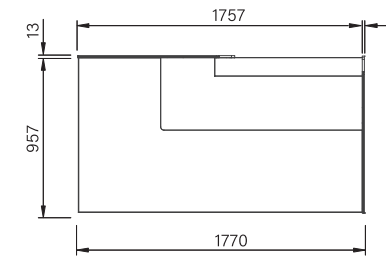

1 mensola

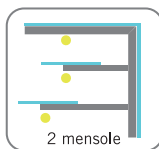

2 mensole

Mod.

110

160

210

90° DX - SX

DIMENSIONI / DIMENSIONS / TAILLE / GRÖSSE

Lunghezza / Length / Longueur / Länge [mm]	1092	1607	2117	1770
Profondità / Depth / Profondeur / Tiefe [mm]	970	970	970	970
Altezza / Height / Hauteur / Höhe [mm]	1220/1380	1220/1380	1220/1380	1220/1380

PESO / WEIGHT / POIDS / GEWICHT [kg]	214/224	285/302	337/353	325/335
---	---------	---------	---------	---------

IMBALLO / EMBALLAGE / PACKAGING / VERPACKUNG

Lunghezza / Length / Longueur / Länge [mm]	1220	1720	2260	1790
Profondità / Depth / Profondeur / Tiefe [mm]	1270	1270	1270	1200
Altezza / Height / Hauteur / Höhe [mm]	1560	1560	1560	1560

POTENZA COMPRESSORE / POWER COMPRESSOR / PUISSANCE COMPRESSEUR / LEISTUNG VERDICHTER

(Monofase / Single-phase / Monophasé / Einphasig)				
Tensione / Supply / Tension / Spannung [V/Ph/Hz]	230/1/50	230/1/50	230/1/50	230/1/50
Potenza assorbita / Electrical power output / Puissance absorbée / Absorbierte Leistung [kW]	0,66	0,85	1,1	0,85
Sbrinatorio / In Defrost / Dégivrage / Zeitgesteuerte [kW]	-	-	-	-



SOFT



STATIC



+2 / +4 °C



4 (30°C - 55%UR)



CALDO A SECCO
Dry heat
Chaud à sec
Trockene Wärme



H=1220

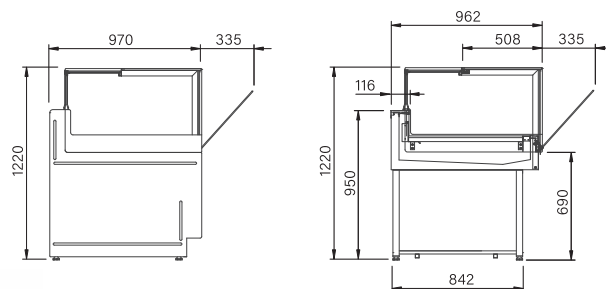

H=1380

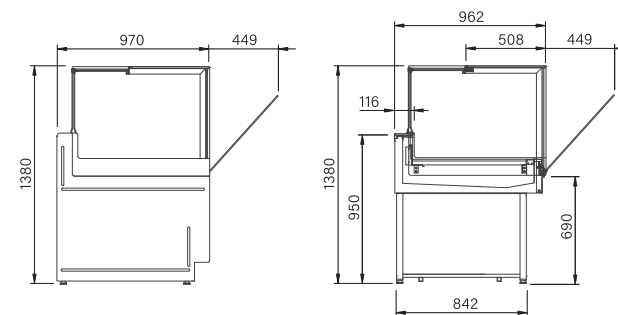

110

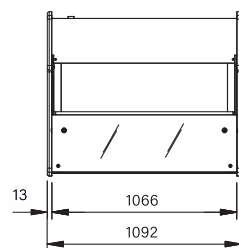

160

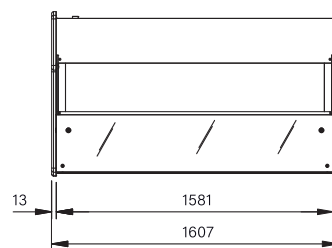

210

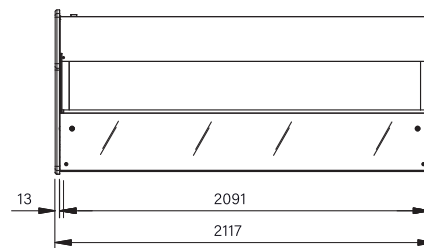

90° DX - SX

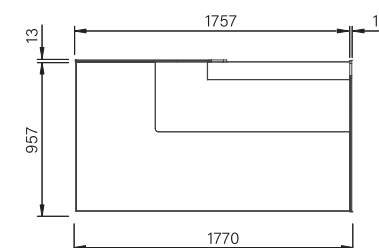

Mod.	110	160	210	90° DX - SX
DIMENSIONI / DIMENSIONS / TAILLE / GRÖSSE				
Lunghezza / Length / Longueur / Länge [mm]	1092	1607	2117	1770
Profondità / Depth / Profondeur / Tiefe [mm]	970	970	970	970
Altezza / Height / Hauteur / Höhe [mm]	1220/1380	1220/1380	1220/1380	1220/1380
PESO / WEIGHT / POIDS / GEWICHT [kg]				
	193/203	263/273	315/325	263/273
IMBALLO / EMBALLAGE / PACKAGING / VERPACKUNG				
Lunghezza / Length / Longueur / Länge [mm]	1220	1720	2260	1790
Profondità / Depth / Profondeur / Tiefe [mm]	1270	1270	1270	1200
Altezza / Height / Hauteur / Höhe [mm]	1560	1560	1560	1560
POTENZA COMPRESSORE / POWER COMPRESSOR / PUISSANCE COMPRESSEUR / LEISTUNG VERDICHTER				
(Monofase / Single-phase / Monophasé / Einphasig)				
Tensione / Supply / Tension / Spannung [V/Ph/Hz]	230/1/50	230/1/50	230/1/50	230/1/50
Potenza assorbita / Electrical power output Puissance absorbée / Absorbierte Leistung [kW]	0,6	1,2	1,8	1,2
Sbrinamento / In Defrost / Dégivrage / Zeitgesteuerte [kW]	-	-	-	-



+40 / +60 °C



BAGNO MARIA
Bain marie
Bain-marie
Wasserbad

H=1220

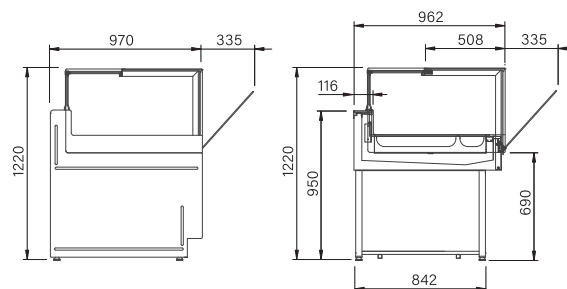

H=1380

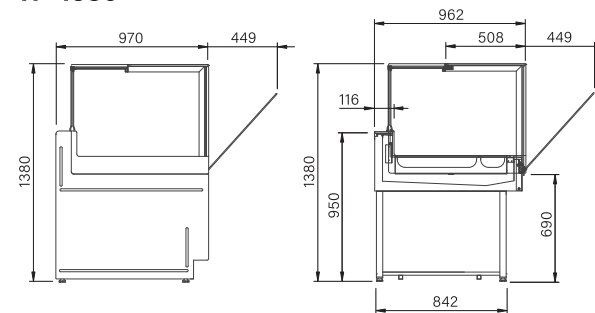

110

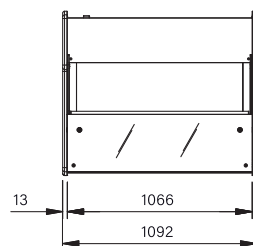

160

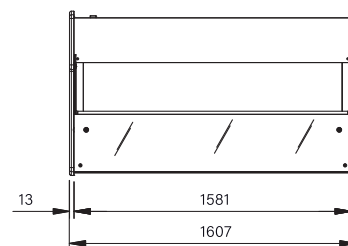

210

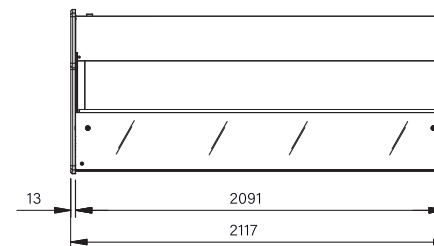

VASCHETTE (standard)
Containers (standard)
Conteneurs (standard)
Schalen (standard)



Mod.

110

160

210

DIMENSIONI / DIMENSIONS / TAILLE / GRÖSSE

Lunghezza / Length / Longueur / Länge [mm]	1092	1607	2117
Profondità / Depth / Profondeur / Tiefe [mm]	970	970	970
Altezza / Height / Hauteur / Höhe [mm]	1220/1380	1220/1380	1220/1380

PESO / WEIGHT / POIDS / GEWICHT [kg]	193/203	263/273	315/325
---	---------	---------	---------

IMBALLO / EMBALLAGE / PACKAGING / VERPACKUNG

Lunghezza / Length / Longueur / Länge [mm]	1220	1720	2260
Profondità / Depth / Profondeur / Tiefe [mm]	1270	1270	1270
Altezza / Height / Hauteur / Höhe [mm]	1560	1560	1560

POTENZA COMPRESSORE / POWER COMPRESSOR / PUISSANCE COMPRESSEUR / LEISTUNG VERDICHTER

(Monofase / Single-phase / Monophasé / Einphasig)			
Tensione / Supply / Tension / Spannung [V/Ph/Hz]	230/1/50	230/1/50	230/1/50
Potenza assorbita / Electrical power output			
Puissance absorbée / Absorbierte Leistung [kW]	1,5	2,4	3
Sbrinatorio / In Defrost / Dégivrage / Zeitgesteuerte [kW]	-	-	-



+40 / +90 °C



Follow us
Italproget



ITALPROGET

Bettona (PG) ITALY

T.: +39 075 987038

email: info@italproget.it

www.italproget.it

