

SENNEBOGEN 613

- 13.5t pick & carry Capability enclosed
- Climatised cabin
- Maxicab tilt cabin

- 15.0t
- 20.0m boom
- 25.0m with fly jib

- Rubber tracks
- Load moment indicator system
- Hydraulic extendable undercarriage
- 3/1 Fall hook block



The Sennebogen 613 has a 18.8m robust 3-section telescopic boom that can be used under load - even on rough terrain. A 15 tonne capacity make it simple to use and easy to transport. Consider the possibilities...

SPECIFICATIONS SUPERCRAANE

SENNEBOGEN 613

DIMENSIONS

Length	8501mm
Width	3000mm Retracted 4000mm Extended
Height	2921mm
Weight	22000kg

CAPACITY

Max. capacity	15000kg at 2.0m
Max. working radius	(main boom) 1100kg at 17.3m
Max. working radius	(fly jib) 700kg at 20.0m
Max. lifting height	(main boom) 19.0m
Max. lifting height	(fly jib) 24.0m

TRACK

Width	700mm
-------	-------

MIN. TRANSPORT WIDTH

Overall Track	3000mm
Overall Unit	3000mm

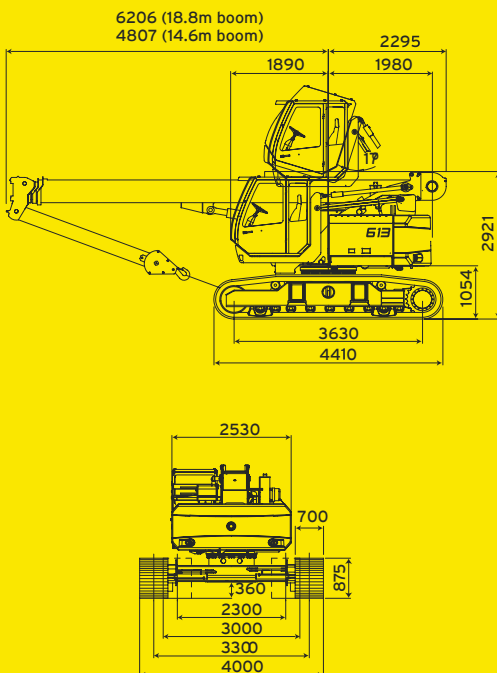

WORKING RANGE

BOOM 9-30M

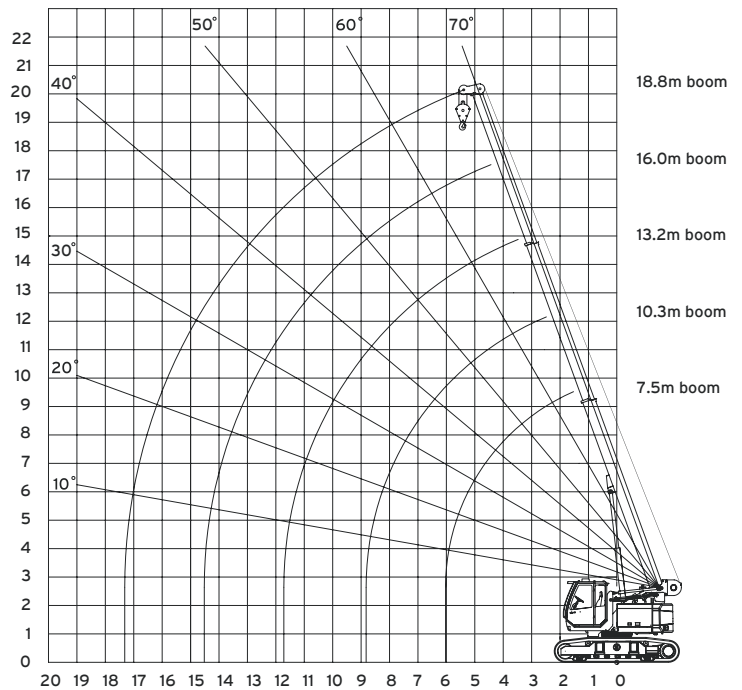

FOLDING JIB 5M

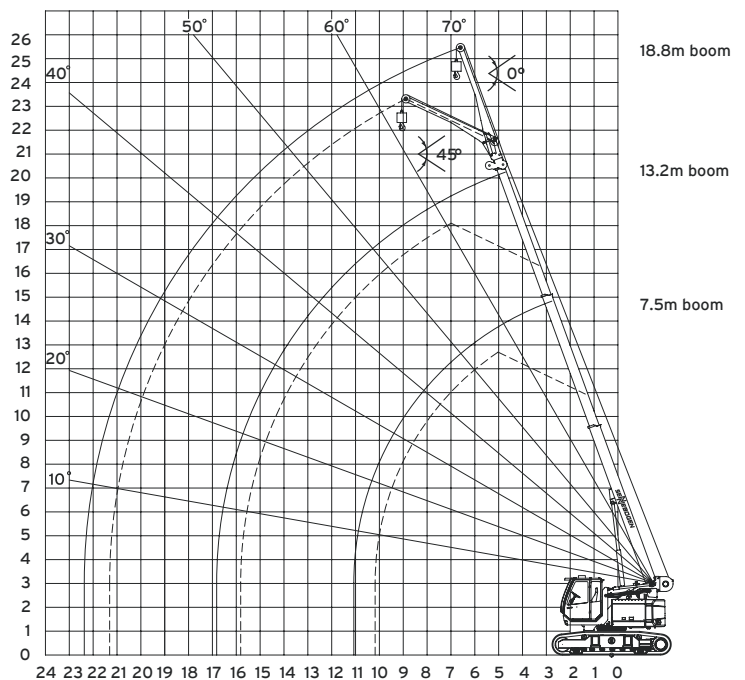





LOAD CHART

SENNEBOGEN 613

5M FOLDING JIB LOAD CHART

18.8m main boom, 5 jib, crawler retracted

TOTAL RATED LOAD

	7.5m Boom		10.3m Boom		13.2m Boom		16.0m Boom		18.8m Boom	
Working Radius (m)	Total Rated Load (t)		Total Rated Load (t)		Total Rated Load (t)		Total Rated Load (t)		Total Rated Load (t)	
										
	0°	45°	0°	45°	0°	45°	0°	45°	0°	45°
2.0										
4.0	3.8		4.4							
5.0	3.3		3.8		4.0					
6.0	2.9	2.0	3.1		3.0		3.0			
7.0	2.5	1.9	2.4	2.0	2.4		2.3		2.3	
8.0	2.1	1.9	2.0	2.0	1.9	1.9	1.9		1.8	
9.0	1.7	1.7	1.6	1.6	1.5	1.5	1.5	1.5	1.5	
10.0	1.4		1.3	1.3	1.3	1.3	1.2	1.2	1.2	1.2
11.0			1.1	1.1	1.0	1.0	1.0	1.0	0.9	0.9
12.0			0.9		0.8	0.8	0.8	0.8	0.8	0.8
13.0			0.7		0.7	0.7	0.6	0.6	0.6	0.6
14.0					0.6		0.5	0.5		

The total rated load charts are based on the actual working radius including boom deflection.











LOAD CHART

SENNEBOGEN 613

MAIN BOOM LOAD CHART

18.8m main boom, pick and carry

TOTAL RATED LOAD

	7.5m Boom		10.3m Boom		13.2m Boom		16.0m Boom		18.8m Boom	
Working Radius (m)	Total Rated Load (t)		Total Rated Load (t)		Total Rated Load (t)		Total Rated Load (t)		Total Rated Load (t)	
										
2.0	13.5	10.8								
3.0	12.0	7.5	9.0	7.6						
4.0	9.5	4.8	9.0	4.8	7.2	4.9				
5.0	7.7	3.3	7.7	3.4	7.2	3.4	5.4	3.5		
5.5	6.8	2.9	6.8	3.1	6.7	3.1	5.4	3.1	4.1	3.1
6.0	5.1/6.0m	2.6/6.0m	6.0	2.6	6.0	2.6	5.3	2.6	4.1	2.6
7.0			4.7	2.1	4.8	2.1	4.7	2.1	4.1	2.1
8.0			3.8	1.6	3.9	1.6	3.9	1.6	3.7	1.7
9.0			3.2/8.8m	1.4/8.8m	3.2	1.4	3.2	1.4	3.2	1.4
10.0					2.7	1.1	2.7	1.1	2.7	1.1
11.0					2.3	0.9	2.3	0.9	2.3	0.9
12.0					2.2/11.6m	0.8/11.6m	2.0	0.7	2.1	0.7
13.0							1.8	0.6	1.8	0.6
14.0							1.5	0.5	1.5	0.5
15.0							1.4/14.4m		1.4	
16.0									1.2	
17.0									1.0/17.3m	











LOAD CHART

SENNEBOGEN 613

MAIN BOOM LOAD CHART

18.8m main boom, stationary

TOTAL RATED LOAD

	7.5m Boom		10.3m Boom		13.2m Boom		16.0m Boom		18.8m Boom	
Working Radius (m)	Total Rated Load (t)		Total Rated Load (t)		Total Rated Load (t)		Total Rated Load (t)		Total Rated Load (t)	
										
2.0	15.0	12.0								
3.0	13.3	8.3	10.0	8.4						
4.0	10.6	5.3	10.0	5.3	8.0	5.4				
5.0	8.5	3.7	8.6	3.8	8.0	3.8	6.0	3.9		
5.5	7.5	3.2	7.6	3.4	7.4	3.4	6.0	3.4	4.5	3.4
6.0	5.7/6.0m	2.9/6.0m	6.7	2.9	6.7	2.9	5.9	2.9	4.5	2.9
7.0			5.2	2.3	5.3	2.3	5.2	2.3	4.5	2.3
8.0			4.2	1.8	4.3	1.8	4.3	1.8	4.1	1.9
9.0			3.6/8.8m	1.5/8.8m	3.5	1.5	3.6	1.5	3.6	1.5
10.0					3.0	1.2	3.0	1.2	3.0	1.2
11.0					2.6	1.0	2.6	1.0	2.6	1.0
12.0					2.4/11.6m	0.9/11.6m	2.2	0.8	2.3	0.8
13.0							2.0	0.7	2.0	0.7
14.0							1.7	0.6	1.7	0.6
15.0							1.6/14.4m		1.5	
16.0									1.3	
17.0									1.1/17.3m	





LOAD CHART

SENNEBOGEN 613

5M FOLDING JIB LOAD CHART

18.8m main boom, 5m jib, crawler extended

TOTAL RATED LOAD

	7.5m Boom		10.3m Boom		13.2m Boom		16.0m Boom		18.8m Boom	
Working Radius (m)	Total Rated Load (t)		Total Rated Load (t)		Total Rated Load (t)		Total Rated Load (t)		Total Rated Load (t)	
										
	0°	45°	0°	45°	0°	45°	0°	45°	0°	45°
4.0	3.8		4.4							
5.0	3.3		3.8		4.2					
6.0	2.9	2.0	3.4		3.8		3.8			
7.0	2.5	1.9	3.1	2.0	3.4		3.5		2.7	
8.0	2.2	1.9	2.8	2.0	3.1	2.0	3.2		2.7	
9.0	2.0	1.8	2.5	1.9	2.8	2.0	2.9	1.9	2.6	
10.0	1.9		2.2	1.9	2.5	1.9	2.6	1.9	2.4	1.8
11.0			2.0	1.8	2.3	1.9	2.4	1.9	2.2	1.7
12.0			1.8		2.2	1.8	2.2	1.9	2.0	1.6
13.0			1.8		2.0	1.8	2.0	1.8	1.9	1.6
14.0					1.7		1.7	1.7	1.7	1.5
15.0					1.5		1.5	1.5	1.4	1.4
16.0					1.4		1.3		1.3	1.3
17.0							1.1		1.1	
18.0							1.0		1.0	
19.0									0.9	
20.0									0.7	