

KOMATSU

PC1250-11 PC1250SP-11

EU Stage V Engine

HYDRAULIC EXCAVATOR



PC1250

ENGINE POWER

578 kW / 775 HP @ 1.800 rpm

OPERATING WEIGHT

Backhoe: 115.900 - 118.300 kg
Loading shovel: 119.500 kg

BUCKET CAPACITY

Backhoe: 6,7 m³ @ 1,8 t/m³
Loading shovel: 6,5 m³ @ 1,8 t/m³

Walk-Around

PG1250-11



ENGINE POWER

578 kW / 775 HP @ 1.800 rpm

OPERATING WEIGHT

Backhoe: 115.900 - 118.300 kg
Loading shovel: 119.500 kg

BUCKET CAPACITY

Backhoe: 6,7 m³ @ 1,8 t/m³
Loading shovel: 6,5 m³ @ 1,8 t/m³

EXCEPTIONAL WORKABILITY AND ENVIRONMENTAL PERFORMANCE

Powerful and Environmentally Friendly

- Fuel efficient high performance Komatsu SAA6D170E-7 engine
- EU Stage V engine
- Adjustable idle shutdown
- Komatsu fuel-saving technology
- 7% fuel consumption reduction

Maximised Efficiency

- Increased productivity (up to 8%)
- Large digging force
- Large drawbar pull and steering force
- Two-mode boom control
- Swing priority mode

First-Class Comfort

- Fully air-suspended operator station
- Low-noise design
- Widescreen monitor

Safety First

- Komatsu SpaceCab™
- KomVision surround view system
- Neutral position detection system
- Hydraulically operated stairway as standard
- Emergency engine stop switches as standard

Quality You Can Rely On

- Komatsu-quality components
- Extensive dealer support network

Komtrax Plus

- Increased operational data and fuel savings



A maintenance program for Komatsu customers

Powerful and Environmentally Friendly



Higher productivity

Work modes include the well-known Power and Economy modes, and the PC1250-11 also benefits from the new “Power plus” (P+) mode, which allows the operator to make full use of the increased engine power to achieve up to 8% higher production than with a PC1250-8 in P mode.

Komatsu fuel-saving technology

Fuel consumption on the PC1250-11 is lower by up to 7%. Engine management is enhanced. The variable speed matching of the engine and hydraulic pumps guarantee efficiency and precision during single and combined movements.

Adjustable idle shutdown

The Komatsu auto idle shutdown automatically turns off the engine after it idles for a set period of time. This feature can easily be programmed from 5 to 60 minutes, to reduce unnecessary fuel consumption and exhaust emissions, and to lower operating costs. An Eco-gauge and the Eco guidance tips on the cab monitor further encourage efficient operations.

PC1250-11

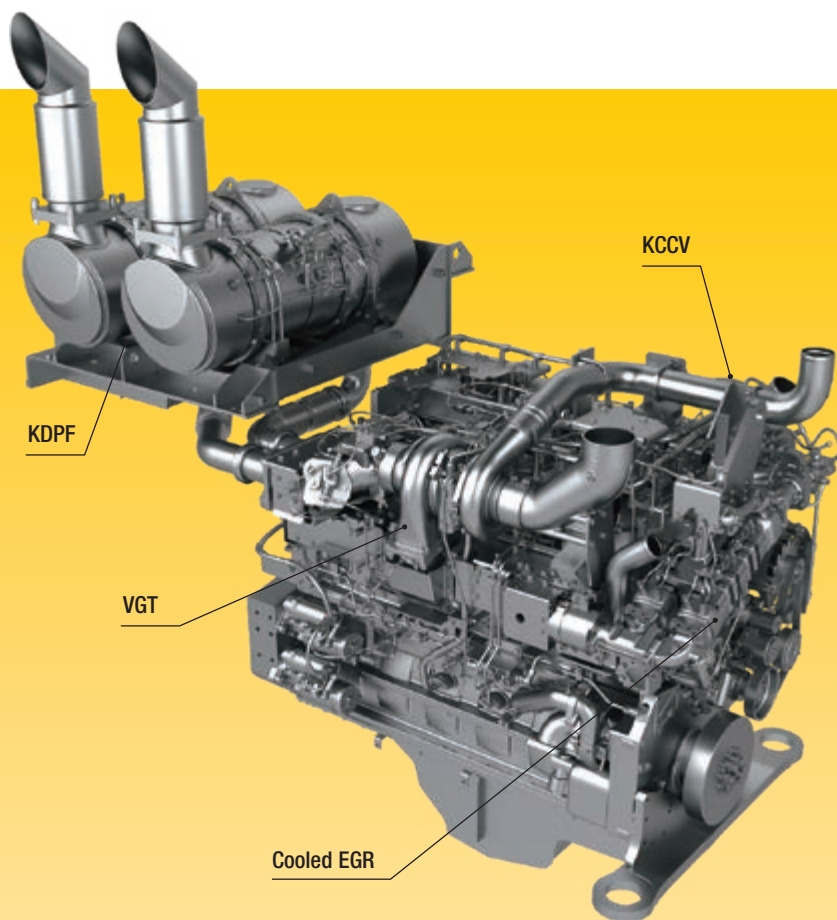

Komatsu EU Stage V engine

The Komatsu SAA6D170E-7 engine is productive, dependable and efficient. With low emissions, it provides a lower environmental impact and a superior performance to help reduce operating costs and lets the operator work in complete peace of mind. It features two Komatsu diesel particulate filters (KDPF), with no need for a selective catalytic reduction (SCR) system.

Exhaust Gas Recirculation (EGR)

Cooled EGR is a technology well-proven in current Komatsu engines. The increased capacity of the EGR cooler now ensures very low NOx emissions and a better engine performance.

Komatsu Closed Crankcase Ventilation (KCCV)

Crankcase emissions (blow-by gas) are passed through a CCV filter. The oil mist trapped in the filter is returned back to the crankcase while the filtered gas is returned to the air intake.

High-Pressure Common Rail (HPCR)

To achieve complete fuel burn and lower exhaust emissions, the heavy-duty High-Pressure Common Rail fuel injection system is computer controlled to deliver a precise quantity of pressurised fuel into the redesigned engine combustion chamber by multiple injections.

Variable Geometry Turbo (VGT)

The VGT provides optimal airflow to the engine combustion chamber under all speed and load conditions. Exhaust gas is cleaner, fuel economy is improved while machine power and performance are maintained.

Electronically controlled variable speed fan

The fan speed is electronically controlled according to actual operating conditions, ensuring maximum deployment of engine power to working, while minimising noise.



Eco-gauge, Eco guidance and fuel consumption gauge



Eco guidance record



Fuel consumption history

Maximised Efficiency

Powerful digging force

Thanks to the high engine output and an optimised hydraulic system, the PC1250-11 delivers a powerful arm crowd force of up to 412 kN (42 tonnes) at PowerMax and a bucket digging force of up to 479 kN (48,8 tonnes) at PowerMax. [PC1250SP-11: 570 kN (58,1 tonnes)]

Shockless boom control

The PC1250-11 features a shockless valve (double-check slow return valve) that automatically reduces the amount of vibration present when operating the boom. Operator fatigue is reduced (which can improve safety and productivity), and spillage caused by vibration is prevented.

Swing priority mode

A twin swing motor system provides excellent swing performance, with high speed and strong braking power. The swing priority setting allows using the same smooth motion for either 180° or 90° loading operations. By altering the oil flow, the operator selects either boom or swing as the priority for increased production.

Large drawbar pull and steering force

Because the machine has a large drawbar pull and a substantial steering force, it provides excellent mobility, even when working on an incline.

Heavy lift mode

Gives the operator 10% more lifting force on the boom when needed for handling rock or heavy lifting applications.



Versatility at your fingertips: select the perfect setting for each job



Full length track roller guards (optional)

Two-mode boom control

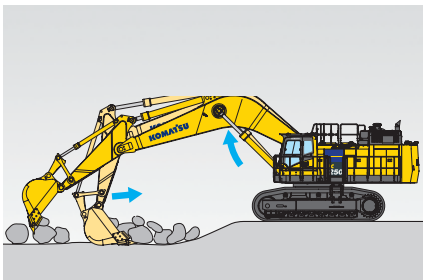

Smooth mode
Boom floats upward, reducing lifting of machine front. This facilitates gathering blasted rock and scraping down operations.

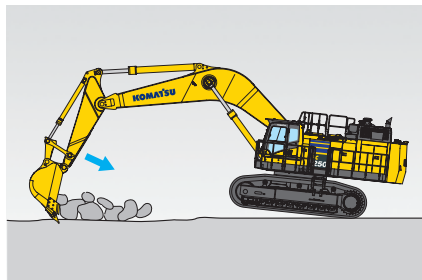

Power mode
Boom pushing force is increased, providing a higher penetration force.



PC1250-11



First-Class Comfort

Increased comfort

In the wide Komatsu SpaceCab™, a standard air-suspended high-back seat, heated and ventilated for improved comfort and with fully adjustable armrests, is the centre of a comfortable and low-fatigue working environment. High visibility and ergonomic controls further assist to maximise the operator's productivity.

Perfect operator convenience

In addition to the standard AM/FM radio, the PC1250-11 has Bluetooth® and an auxiliary input for connecting external devices and playing music through the cab speakers. Two 12-volt power ports are also incorporated in the cab. Proportional controls are fitted as standard for safe and precise operation of attachments.

Low-noise design

Komatsu crawler excavators have very low external noise levels. The optimal usage of sound insulation and of sound absorbing materials helps to make noise levels inside the cab comparable to those of an executive car.



Convenient, ergonomic and precise control: joysticks (short levers are available as option)



Plenty of storage room, a hot and cool box, a magazine box and a cup holder



Armrest with simple height adjustment

PC1250-11

Information & Communication Technology



Lower operating costs

Komatsu ICT contributes to the reduction of operating costs by assisting to comfortably and efficiently manage operations. It raises the level of customer satisfaction and the competitive edge of our products.

Widescreen monitor

Conveniently customisable and with a choice of 26 EU languages, the widescreen monitor with simple switches and multifunction keys gives fingertip access to a large range of functions and operating info. The KomVision images and Eco gauge are now incorporated into the default main screen.

An evolutionary interface

Helpful information is now easier than ever to find and understand with the upgraded monitor interface. An optimal main screen for the ongoing work can be selected simply by pressing the F3 key.

Operation Records (1Day)	
Working Hours (Engine On)	0.2 h
Average Fuel Consumption	23.0 l/h
Actual Working Hours	0.1 h
Avg Fuel Consumption (Actual Working)	23.0 l/h
Fuel Consumption	7.0 l
Idle Time Hours	0.1 h

Quick view on the operation logs



With KomVision, various camera view options are available whilst maintaining constant "birdview" from above the machine

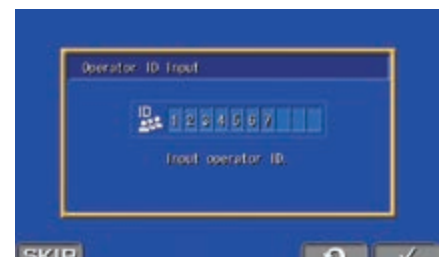

Operator identification function

Komtrax Plus

What

- Komtrax is Komatsu's remote equipment monitoring and management system
- Komtrax is standard equipment on all Komatsu construction products
- Komtrax continuously monitors and records machine health and operational data
- Information such as fuel consumption, utilization, and a detailed history aids in making repair or replacement decisions

When

- Know when your machines are running or idling and make decisions that will improve your fleet utilization
- Detailed movement records ensure you know when and where your equipment is moved
- Up to date records allow you to know when maintenance was done and help you plan for future maintenance needs

Where

- Komtrax data can be accessed virtually anywhere through your computer, the web or your smart phone
- Automatic alerts keep fleet managers up to date on the latest machine notifications

Why

- Knowledge is power - make informed decisions to manage your fleet better
- Knowing your idle time and fuel consumption will help maximize your machine efficiency
- Take control of your equipment - any time, anywhere



KOMTRAX Plus

Equipment management support

Komtrax Plus enables expanded monitoring of the fleet via satellite and wireless LAN. Users can analyze "machine health" and performance from a remote location, on a near-real time basis. This includes component condition and trend data. By making this critical information readily accessible, Komtrax Plus is an effective tool in maximizing productivity and lowering operating cost.

Safety Features

Optimal jobsite safety

Safety features on the Komatsu PC1250-11 comply with the latest industry standards and work in synergy to minimise risks to people in and around the machine. A neutral detection system for travel and work equipment levers increase jobsite safety, along with a seat belt caution indicator and an audible travel alarm. Highly durable anti-slip plates – with additional high friction covering – maintain long term traction performance.



The standard hydraulically operated stairway provides safer access and egress to and from the machine.



Three emergency engine stop switches are installed in the cab and around the machine, as standard.



KomVision cameras



Exceptional operator protection



Hand rails and anti-slip plates

KomVision

With a series of high definition networked cameras fitted on the machine, KomVision provides a crystal clear, real-time bird's eye view of the immediate surroundings on the widescreen cab monitor. The operator can quickly and easily check the machine's vicinity prior to making any movement, and focus on the work at hand even in low light conditions.

Komatsu SpaceCab™

The wide Komatsu SpaceCab™ with user-friendly controls provides a comfortable and safe work environment. A fully adjustable air-suspended seat dampens vibrations and reduces the fatigue of long shifts. Large front and side windows give a superior visibility and higher confidence. This increases the safety for the driver as well as other people and machines on the jobsite. A laminated one piece front glass (ECE 43R) is fitted as standard, as is the Falling Object Protective System (FOPS) with openable front sun visor. A front guard is optionally available as well.

Safe maintenance

Thermal guards around high temperature areas of the engine, protected fan belt and pulleys, a pump/engine partition that prevents hydraulic oil from spraying onto the engine, a wide catwalk and exceptionally sturdy handrails: in Komatsu tradition, the highest safety level is provided for a fast and smooth maintenance.

Easy Maintenance



A wide, illuminated centre walkway provides easy access to many inspection and maintenance points. In addition, inspection and maintenance points are grouped to facilitate easy engine and hydraulic component checks.

Komatsu Care

Komatsu Care is a maintenance program that comes as standard with your new Komatsu machine. It covers factory-scheduled



maintenance, performed with Komatsu Genuine parts by Komatsu-trained technicians. Depending on your machine's engine, it also offers extended coverage of the Komatsu Diesel Particulate Filter (KDPF) or the Komatsu Diesel Oxidation Catalyst (KDOC). Please contact your local Komatsu distributor for terms and conditions.

Long-life oil filters

The Komatsu Genuine hydraulic oil filter uses high-performance filtering material for long replacement intervals, which significantly reduces maintenance costs.

Easy cleaning of radiator

The hydraulically driven fan can be reversed to facilitate cleaning of the cooling unit. In addition, this feature contributes to reducing warm-up time in low temperatures. Hinged A/C condenser and fuel cooler provide easy access to each core.

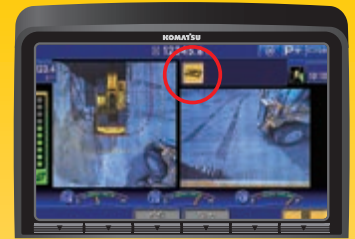

Maintenance time caution lamp

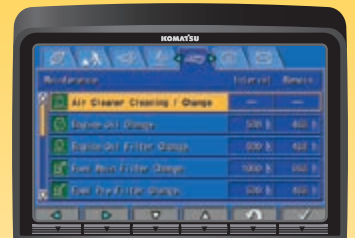

Basic maintenance screen

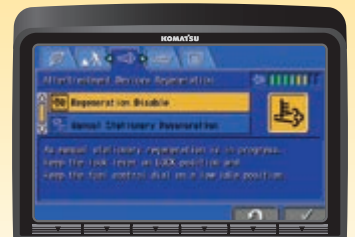

Aftertreatment device regeneration screen for the KDPF

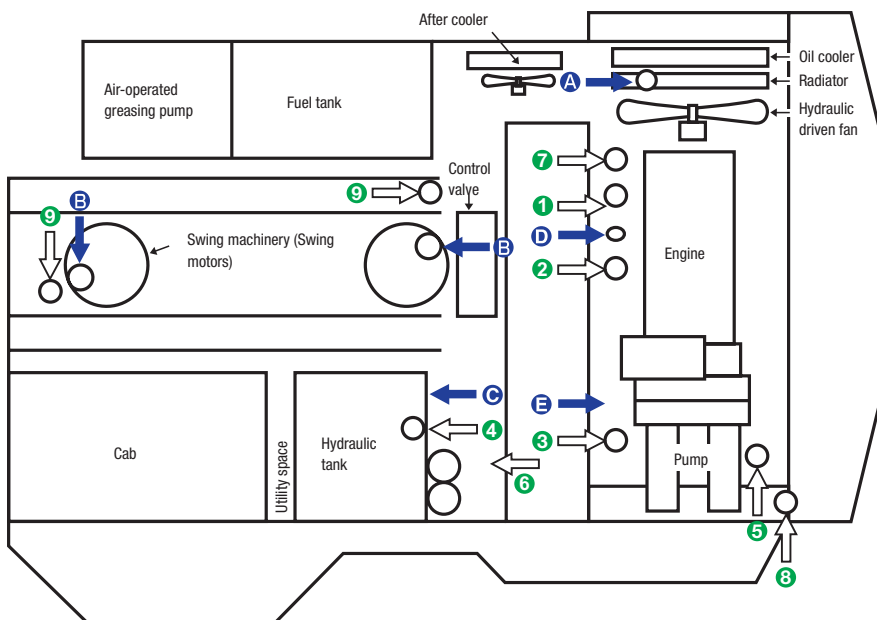

- Ⓐ Coolant
- Ⓑ Swing machinery oil
- Ⓒ Hydraulic oil
- Ⓓ Engine oil
- Ⓔ PTO oil
- ① Fuel filters
- ② Fuel pre-filters
- ③ Engine oil filters
- ④ Hydraulic drain filter
- ⑤ Pilot filter
- ⑥ Hydraulic return filters
- ⑦ KCCV filter
- ⑧ PTO strainer
- ⑨ Swing motor cooling filters

Quality You Can Rely On



Rugged design

The undercarriage of the PC1250-11 is specifically designed to cope with the heavy forces to be found in hard quarry operations. With heavy duty double grouser track shoes and roller guard options, the moving parts of the undercarriage are strongly shielded against damage from rocks, while traction force and ground pressure may be optimized for your particular site.

Komatsu-quality

With the latest computer techniques and a thorough test programme, Komatsu's global know-how produces equipment to meet your highest standards.

Reliable and efficient

Productivity is the key to success – all major components of the PC1250-11 are designed and manufactured by Komatsu. All essential functions are perfectly matched for a highly reliable and productive machine.

High strength boom and arm

Thanks to the large cross-sectional structure made with high tensile strength steel and a thick plate and partition wall, the boom and arm provide excellent durability and are highly resistant to bending and twisting. Highly durable rubbing strips on the underside of the arm protect the structure from damage. The reinforced short boom and arm specification allows to increase the bucket capacity.



Sturdy travel motor guards and rock protectors



Clogging detector in hydraulic return filter prevents damage of hydraulic system



Komatsu bucket with Kmax teeth

Specifications

ENGINE

Model	Komatsu SAA6D170E-7
Type	4-cycle, water-cooled, direct injection, turbocharged, air-to-air charge air cooler, cooled EGR
Engine power	
at rated engine speed	1.800 rpm
SAE J1995	578 kW / 775 HP
ISO 9249 / SAE J1349* (net engine power)	565 kW / 758 HP
No. of cylinders	6
Bore x stroke	170 x 170 mm
Displacement	23,15 l
Fan drive type	Hydraulic
Engine emissions	EU Stage V compliant
Fuel	Diesel fuel, conforming to EN590 Class 2/Grade D. Paraffinic fuel capability (HVO, GTL, BTL), conforming to EN 15940:2016
*Net horsepower at the maximum speed of radiator cooling fan	519 kW / 696 HP

HYDRAULIC SYSTEM

Type	Open-centre load sensing system
Main pump	3 variable displacement piston pumps supplying boom, arm, bucket, swing and travel circuits
Maximum pump flow	
Implement and travel	2 x 494 l/min
Swing	1 x 600 l/min
Sub-pump for control circuit	Gear pump
Hydraulic motors	
Travel	2 x axial piston motors with parking brake
Swing	2 x axial piston motors with swing holding brake
Relief valve settings	
Backhoe	320 kg/cm ²
Loading shovel	320 kg/cm ²
Travel	350 kg/cm ²
Swing	300 kg/cm ²
Pilot circuit	32 kg/cm ²
Hydraulic cylinders (no. of cylinders – bore x stroke):	
Boom	2 – 225 mm x 2.390 mm
Arm	1 – 250 mm x 2.435 mm
Standard bucket	2 – 160 mm x 1.825 mm
SP bucket	2 – 160 mm x 1.950 mm

SWING SYSTEM

Type	2 x hydraulic motors
Swing reduction	Planetary gear
Swing circle lubrication	Grease-bathed
Swing lock	Oil disc brake
Swing speed	5,8 rpm

DRIVES AND BRAKES

Steering control	2 levers with pedals, giving full independent control of each track
Drive method	Hydrostatic
Travel motor	Axial piston motor, in-shoe design
Reduction system	Planetary triple reduction
Gradeability	70%
Max. travel speeds	
Lo / Hi	2,3 / 3,3 km/h
Maximum drawbar pull	70.000 kg
Service brake	Hydraulic lock
Parking brake	Hydraulic lock

UNDERCARRIAGE

Construction	H-leg frame with box section track frames
Track assembly	
Type	Fully sealed
Shoes (each side)	48
Tension	Hydraulic
Rollers	
Track rollers (each side)	8
Carrier rollers (each side)	3

SERVICE REFILL CAPACITIES

Fuel tank	1360 l
Radiator	142 l
Engine oil	86 l
Swing drive	2 x 20 l
Hydraulic tank	670 l
Final drive (each side)	21 l
Power Take Off (PTO)	13,5 l

OPERATING WEIGHT (APPR.)

Backhoe: PC1250-11: Operating weight, including 9.100 mm boom, 3.400 mm arm, SAE J 296 heaped 5,0 m³ backhoe bucket, operator, lubricant, coolant, full fuel tank, and standard equipment.

PC1250SP-11: Operating weight, including 7.800 mm boom, 3.400 mm arm, SAE J 296 heaped 6,7 m³ backhoe bucket, full length roller guard, operator, lubricant, coolant, full fuel tank, and standard equipment.

Loading Shovel: Operating weight, including 5.300 mm boom, 3.800 mm arm, SAE J 296 heaped 6,5 m³ bottom dump bucket, full length roller guard, operator, lubricant, coolant, full fuel tank, and standard equipment.

Double grouser shoes	PC1250-11		PC1250SP-11	
	Operating weight	Ground pressure	Operating weight	Ground pressure
700 mm	115.900 kg	1,51 kg/cm ²	118.300 kg	1,54 kg/cm ²
1.000 mm	118.200 kg	1,08 kg/cm ²	–	–

Dimensions & Performance Figures

MACHINE DIMENSIONS		PC1250-11		PC1250SP-11	PC1250-11 Loading Shovel
		9,1 m boom		7,8 m boom	5,3 m boom
	3,4 m arm	4,5 m arm	5,7 m arm	3,4 m arm	3,8 m arm
A	Overall height	6.040 mm	6.460 mm	6.990 mm	6.200 mm
B	Overall length	16.070 mm	16.100 mm	14.840 mm	10.990 mm

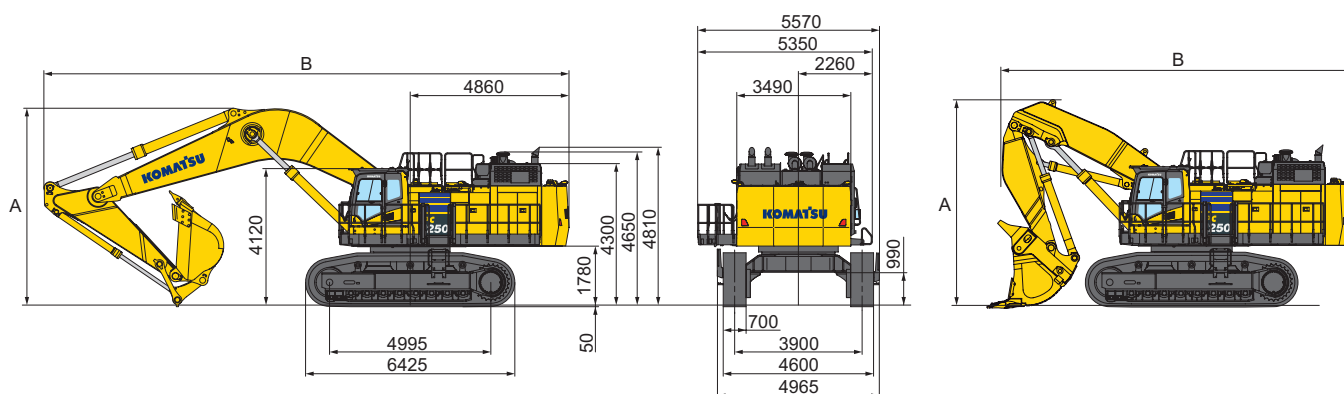

MAX. BUCKET CAPACITY AND WEIGHT

PC1250-11

Arm length / Max. pin load	3,4 m / 15.140 kg	4,5 m / 13.580 kg	5,7 m / 9.833 kg
Material weight up to 1,4 t/m ³	6,0 m ³ 6.740 kg	5,5 m ³ 5.950 kg	3,80 m ³ 4.510 kg
Material weight up to 1,6 t/m ³	5,6 m ³ 6.180 kg	5,2 m ³ 5.420 kg	3,54 m ³ 4.388 kg
Material weight up to 1,8 t/m ³	5,2 m ³ 5.780 kg	4,7 m ³ 5.170 kg	3,28 m ³ 3.933 kg

PC1250SP-11

Arm length / Max. pin load	3,4 m / 18.568 kg
Material weight up to 1,4 t/m ³	7,57 m ³ 7.970 kg
Material weight up to 1,6 t/m ³	7,01 m ³ 7.352 kg
Material weight up to 1,8 t/m ³	6,70 m ³ 6.505 kg

PC1250-11 Loading Shovel

Arm length / Max. pin load	3,8 m / 22.700 kg
Material weight up to 1,4 t/m ³	8,00 m ³ 11.500 kg
Material weight up to 1,6 t/m ³	7,20 m ³ 10.600 kg
Material weight up to 1,8 t/m ³	6,50 m ³ 9.730 kg

Max. capacity and weight have been calculated according to ISO 10567:2007.

Please consult with your distributor for the correct selection of buckets and attachments to suit the application.

Working Range

PC1250-11

PC1250/SP-11

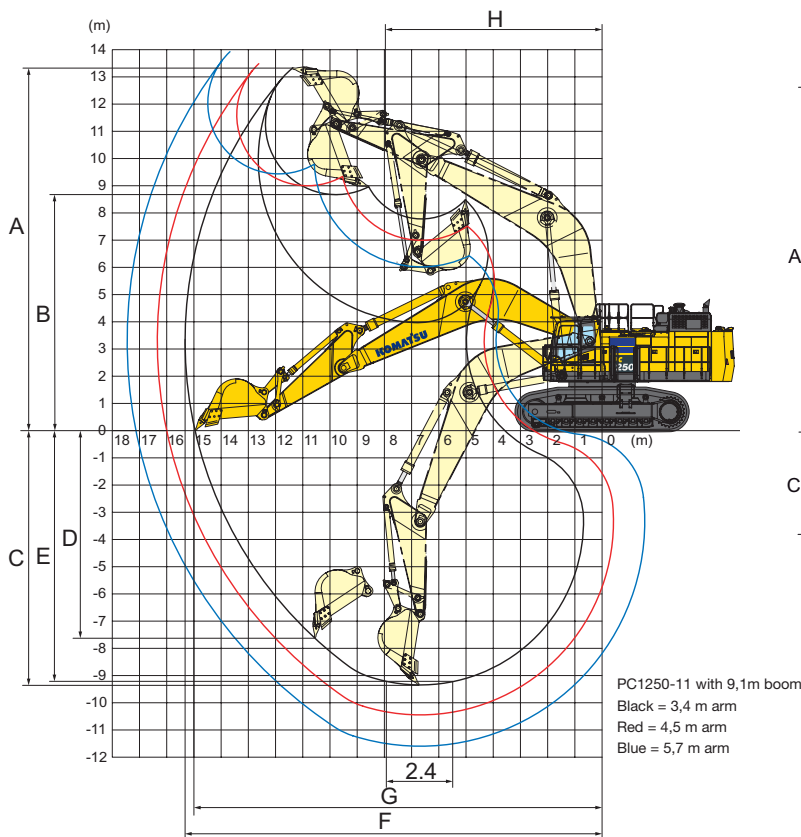

PC1250-11 LOADING SHOVEL

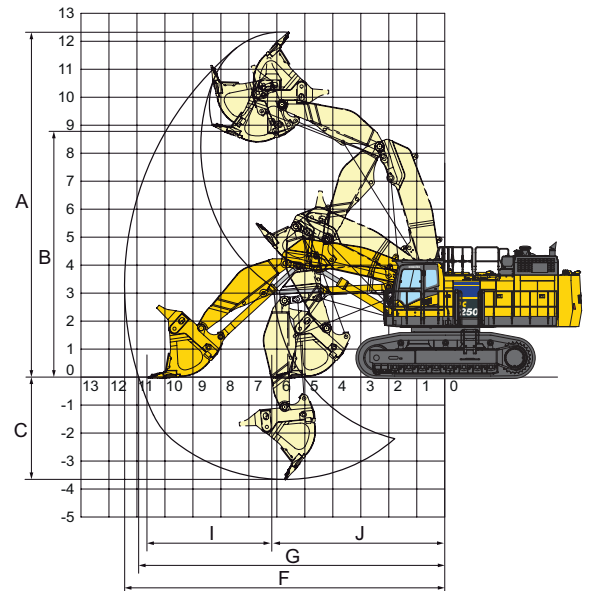

WORKING RANGE

		PC1250-11			PC1250SP-11	PC1250-11 LS
		9,1 m boom			7,8 m boom	5,3 m boom
		3,4 m arm	4,5 m arm	5,7 m arm	3,4 m arm	3,8 m arm
A	Max. digging (cutting) height	13.400 mm	13.490 mm	13.910 mm	13.000 mm	12.330 mm
B	Max. dumping height	8.680 mm	9.000 mm	9.440 mm	8.450 mm	8.700 mm
C	Max. digging depth	9.350 mm	10.440 mm	11.590 mm	7.900 mm	3.650 mm
D	Max. vertical wall digging depth	7.610 mm	8.490 mm	9.480 mm	5.025 mm	-
E	Max. digging depth of cut for 8' level	9.220 mm	10.340 mm	11.500 mm	7.745 mm	-
F	Max. digging reach	15.350 mm	16.340 mm	17.450 mm	14.070 mm	11.400 mm
G	Max. digging reach at ground level	15.000 mm	16.000 mm	17.130 mm	13.670 mm	10.900 mm
H	Min. swing radius	7.965 mm	7.990 mm	8.150 mm	6.415 mm	-
I	Level crowding distance	-	-	-	-	4.480 mm
J	Min. crowding distance	-	-	-	-	6.130 mm
SAE J1179 Rating	Bucket digging force	422 kN 43.000 kg	422 kN 43.000 kg	343 kN 35.000 kg	502 kN 51.200 kg	-
	Arm crowd force	392 kN 40.000 kg	327 kN 33.300 kg	281 kN 28.700 kg	395 kN 40.300 kg	-
ISO 6015 Rating	Bucket digging force	479 kN 48.800 kg	479 kN 48.800 kg	389 kN 39.700 kg	570 kN 58.100 kg	579 kN 59.000 kgf
	Arm crowd force	412 kN 42.000 kg	337 kN 34.400 kg	286 kN 29.200 kg	412 kN 42.000 kg	608 kN 62.000 kgf

Transportation Guide

WORK EQUIPMENT WEIGHT

PC1250: 25,7 t
 27,2 t (Heavy-duty version)
 PC1250SP: 28,0 t

BOOM



PC1250: 11,2 t / 9.475 × 2.894 × 1.474 mm
 PC1250SP: 11,1 t / 8.170 × 3.095 × 1.474 mm
 PC1250LS: 7,1 t / 5.650 × 2.000 × 1.500 mm

ARM (INCL. 2 BUCKET CYLINDERS)



PC1250: 6,1 t / 4.895 × 1.626 × 890 mm
 6,4 t / 4.895 × 1.626 × 890 mm
 (Heavy-duty version)
 PC1250SP: 6,6 t / 4.914 × 1.683 × 890 mm
 PC1250LS: 5,2 t / 4.100 × 1.900 × 1.300 mm

BUCKET

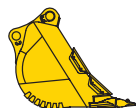

PC1250: 4,6 t / 2.700 × 2.100 × 2.050 mm
 5,8 t / 2.580 × 2.276 × 2.250 mm
 (Heavy-duty version)
 PC1250SP: 6,5 t / 2.527 × 2.420 × 2.520 mm
 PC1250LS: 10,9 t / 3.000 × 2.700 × 2.700 mm

ARM CYLINDER



Weight: 1,5 t
 Length: 3.950 mm
 PC1250-11 LS:
 Weight: 1,2 t [0,6 t × 2],
 Length: 2.980 mm

BOOM CYLINDER



Weight: 2,3 t [1,15 t × 2]
 Length: 3.810 mm
 PC1250-11 LS:
 Weight: 2,2 t [1,1 t × 2],
 Length: 3.520 mm

BUCKET CYLINDER

PC1250-11 LS:
 Weight: 1,7 t [0,85 t × 2],
 Length: 3.300 mm

UPPER STRUCTURE

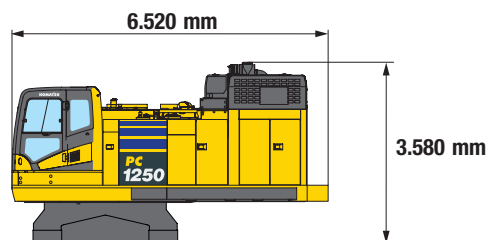

Weight: 39,9 t
 Width: 3.495 mm

UNDERCARRIAGE

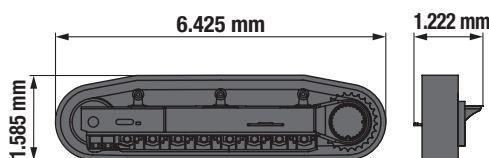

Weight:
 31,4 t [15,7 t × 2]
 32,2 t [16,1 t × 2] (With full length track roller guard)

OTHERS

Weight: 17,8 t

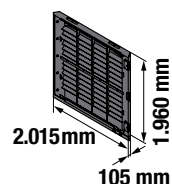
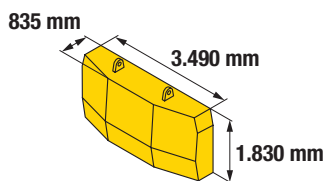

Weight: 16,7 t

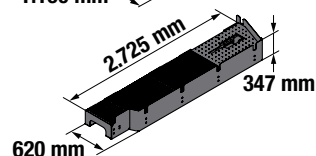
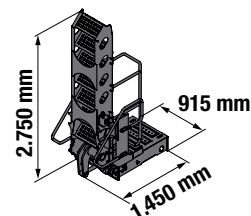
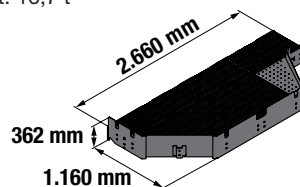

Transportation volume (length x height x width)
 Specs shown include the following equipment:
 Backhoe: boom 9.100 mm, arm 3.400 mm, bucket 5,0 m³, shoes 700 mm double grouser
 Loading shovel (LS): boom 5.300 mm, arm 3.800 mm, bucket 6,5 m³

Lifting Capacity

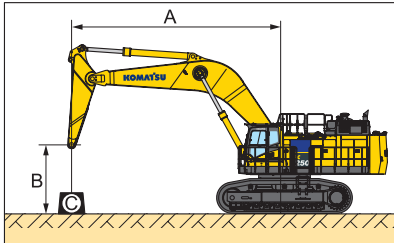

A – Reach from swing centre

– Rating over front

Weights without bucket

B – Bucket hook height

– Rating over side

With 700 mm shoes

C – Lifting capacities

– Rating at maximum reach

PC1250-11 / BOOM LENGTH 9,1 M / LIFTING MODE: ON

Arm length	A				12,2 m		10,7 m		9,1 m		7,6 m		6,1 m		4,6 m	
	B															
Heavy Lift: ON 3,4 m	9,1 m	kg	*22.750	21.750			*23.400	*23.400								
	6,1 m	kg	21.850	18.000	22.450	18.550	*25.200	22.850	*28.000	*28.000	*32.850	*32.850				
	3,0 m	kg	20.400	16.750	21.700	17.800	26.200	21.400	32.500	26.350	*40.050	33.500				
	0,0 m	kg	21.000	17.150	21.150	17.300	25.250	20.500	31.100	25.050	40.350	32.000				
	-3,0 m	kg	24.500	19.950			25.300	20.550	31.000	24.950	*40.300	32.050	*49.000	44.900	*41.250	*41.250
	-6,1 m	kg	*26.000	*26.000							*30.200	*30.200	*37.300	*37.300		
Heavy Lift: OFF 3,4 m	9,1 m	kg	*20.750	*20.750			*20.900	*20.900								
	6,1 m	kg	*20.350	18.000	*21.150	18.550	*22.450	*22.450	*25.000	*25.000	*29.350	*29.350				
	3,0 m	kg	20.400	16.750	21.700	17.800	*24.900	21.400	*28.950	26.350	*35.650	33.500				
	0,0 m	kg	21.000	17.150	21.150	17.300	25.250	20.500	*31.000	25.050	*37.800	32.000				
	-3,0 m	kg	*23.550	19.950			*24.650	20.550	*29.750	24.950	*35.750	32.050	*43.500	*43.500	*37.700	*37.700
	-6,1 m	kg	*22.900	*22.900							*26.650	*26.650	*32.900	*32.900		

Heavy Lift: ON 4,5 m	9,1 m	kg	*15.900	*15.900	*18.550	*18.550										
	6,1 m	kg	*15.650	*15.650	*21.500	18.700	*22.900	*22.900	*25.200	*25.200						
	3,0 m	kg	*16.400	14.750	21.600	17.650	*26.100	21.350	*30.200	26.450	*36.900	33.850				
	0,0 m	kg	*18.300	14.950	20.700	16.850	24.850	20.100	30.750	24.650	39.850	31.500	*32.350	*32.350		
	-3,0 m	kg	20.800	16.900			24.450	19.750	30.200	24.100	39.350	31.000	*50.850	43.400	*36.350	*36.350
	-6,1 m	kg	*24.700	22.850					*28.150	25.000	*34.700	32.050	*42.550	*42.550	*53.100	*53.100
Heavy Lift: OFF 4,5 m	9,1 m	kg	*14.450	*14.450	*16.850	*16.850										
	6,1 m	kg	*14.250	*14.250	*19.100	18.700	*20.350	*20.350	*22.500	*22.500						
	3,0 m	kg	*14.900	14.750	*20.800	17.650	*23.150	21.350	*26.800	26.450	*32.800	*32.800				
	0,0 m	kg	*16.650	14.950	20.700	16.850	24.850	20.100	*29.750	24.650	*36.500	31.500	*29.550	*29.550		
	-3,0 m	kg	*20.400	16.900			24.450	19.750	*29.850	24.100	*36.150	31.000	*45.050	43.400	*33.150	*33.150
	-6,1 m	kg	*21.750	*21.750					*24.800	*24.800	*30.650	*30.650	*37.550	*37.550	*46.850	*46.850

* Load is limited by hydraulic capacity rather than tipping.

Ratings are based on SAE Standard No. 10567.

Rated loads do not exceed 87% of hydraulic lift capacity or 75% of tipping load.

Lifting capacity stated is based on lifting with bare arm. When lifting with additional equipment installed to the arm, please subtract the weight of all additional equipment from the values stated.

PC1250-11

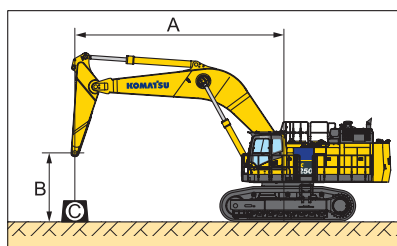

A – Reach from swing centre

– Rating over front

Weights without bucket

B – Bucket hook height

– Rating over side

With 700 mm shoes

C – Lifting capacities

– Rating at maximum reach

PC1250-11 / BOOM LENGTH 9,1 M / LIFTING MODE: ON

Arm length	A			13,7		12,2		10,7		9,1		7,6		6,1	
	B														
Lifting mode: ON 	9,1 kg	*11.750	*11.750												
	6,1 kg	*11.600	*11.600	*18.450	15.650	*19.450	19.050								
	3,0 kg	*12.050	*12.050	18.150	14.850	21.700	17.800	*24.200	21.600	*27.750	26.950	*33.550	*33.550		
	0,0 kg	*13.250	13.150	17.450	14.150	20.600	16.700	24.800	20.000	30.750	24.650	*39.350	31.550	*35.350	*35.350
	-3,0 kg	*15.700	14.450			20.050	16.200	24.000	19.250	29.700	23.650	38.750	30.400	*50.200	42.450
Heavy Lift: OFF 	9,1 kg	*10.650	*10.650												
	6,1 kg	*10.500	*10.500	*16.650	15.650	*17.250	*17.250								
	3,0 kg	*10.900	*10.900	*17.900	14.850	*19.300	17.800	*21.400	*21.400	*24.600	*24.600	*29.750	*29.750		
	0,0 kg	*12.000	*12.000	17.450	14.150	20.600	16.700	*24.050	20.000	*28.300	24.650	*34.850	31.550	*32.250	*32.250
	-3,0 kg	*14.250	*14.250			20.050	16.200	24.000	19.250	*29.600	23.650	*36.100	30.400	*45.800	42.450
	-6,1 kg	*19.500	18.300					*22.350	19.650	*27.150	23.950	*33.000	30.850	*40.950	*40.950

PC1250SP-11 / BOOM LENGTH 7,8 M / LIFTING MODE: ON

Arm length	A			12,2		10,7		9,1		7,6		6,1		4,6	
	B														
Lifting mode: ON 	9,1 kg	*21.000	*21.000					*28.700	*28.700						
	6,1 kg	*20.100	*20.100			27.800	22.950	*30.800	29.250	*34.900	*34.900	*42.200	*42.200		
	3,0 kg	*21.050	19.800			26.750	21.950	33.550	27.350	*41.500	35.300				
	0,0 kg	*24.250	20.600			26.050	21.250	32.200	26.050	41.950	33.450	*55.350	46.300		
	-3,0 kg	*28.450	25.300					*30.450	26.250	*38.700	33.450	*47.850	46.650	*59.200	*59.200
Heavy Lift: OFF 	9,1 kg	*19.100	*19.100					*25.800	*25.800						
	6,1 kg	*18.300	*18.300			*25.450	22.950	*27.600	*27.600	*31.350	*31.350	*37.950	*37.950		
	3,0 kg	*19.150	*19.150			26.750	21.950	*30.850	27.350	*37.100	35.300				
	0,0 kg	*22.050	20.600			26.050	21.250	*32.050	26.050	*39.000	33.450	*49.350	46.300		
	-3,0 kg	*25.250	*25.250					*27.050	26.250	*34.400	33.450	*42.550	*42.550	*52.550	*52.550
	-6,1 kg														

* Load is limited by hydraulic capacity rather than tipping.

Ratings are based on SAE Standard No. 10567.

Rated loads do not exceed 87% of hydraulic lift capacity or 75% of tipping load.

Lifting capacity stated is based on lifting with bare arm. When lifting with additional equipment installed to the arm, please subtract the weight of all additional equipment from the values stated.

Standard and Optional Equipment

ENGINE

Komatsu SAA6D170E-7 turbocharged common rail direct injection diesel engine	●
EU Stage V compliant	●
Automatic engine warm-up system	●
Auto-deceleration function	●
Adjustable idle shutdown	●
Dry type air cleaner, double element	●
Fuel pre-filter with water separator	●
Variable speed cooling fan, hydraulic drive, reversible	●
Battery disconnect switch	●
Circuit breaker	●
Alternator 24 V / 90 A	●
Starter motor 2 × 24 V / 11 kW	●
Batteries 2 × 12 V / 220 Ah	●

HYDRAULIC SYSTEM

2 speed travel system with auto shift	●
3 working modes (Power plus, Power, Economy)	●
Automatic swing holding brake	●
Fully hydraulic, with Open-Center Load-Sensing and engine speed sensing (Pump and engine mutual control system)	●
Heavy lift mode	●
In-line high pressure filters	●
Pressure Proportional Control (PPC) hydraulic control system	●
Shockless control system for boom	●
Two-mode setting for boom	●

WORK EQUIPMENT

Arms (Backhoe):	
3.400 mm HD arm assembly	○
3.400 mm SP arm assembly	○
4.500 mm HD arm assembly	○
5.700 mm arm assembly	○
Booms (Backhoe):	
7.800 mm SP boom assembly	○
9.100 mm boom assembly	○
Loading shovel assembly	
5.300 mm boom & 3.800 mm arm	○

CABIN

Cab with fixed type front window	●
Heated and ventilated high-back air-suspended seat	●
12 Volt power supply	●
Automatic climate control system, with defroster	●
AM/FM radio with Bluetooth®	●
Auxiliary input (3,5 mm jack)	●
Secondary engine shut down switch	●
KomVision surround view system	●
Large high resolution LCD color monitor	●
Lock lever	●
Mirrors (RH,LH)	●
Washable cab floor mat	●
Seat belt, 78 mm	●
Bolt-on top guard, OPG Level 2 (ISO 10262)	●
Full front guard	○

UNDERCARRIAGE

Carrier rollers, 3 (Each side)	●
Hydraulic track adjusters (Each side)	●
Track rollers, 8 (Each side)	●
Track shoes, 700 mm double grouser	●
Track frame undercovers (Centre)	●
Track guiding guards (Each side)	●
Travel motor guards	●
Rock protectors	●
Track roller guard (Full length)	○
Shoes: 1.000 mm double grouser	○

FULL LED LIGHTING SYSTEM

Working lights: 2 boom, 2 cab roof, 1 right front	●
Walkthrough light	●
Step light with timer	●
Rear working light	●
Flashing light connected with horn	●

OTHER EQUIPMENT

Counterweight, 16.700 kg	●
Electric priming pump for fuel	●
Equipment Management Monitoring System	●
General tool kit	●
Grease gun, electric pump	●
Hand rails & guard rails	●
Horn, air	●
Komtrax Plus	●
One-touch engine oil drainage	●
Preventive Maintenance (PM) tune-up service connector	●
Rear reflectors	●
Seat belt indicator	●
Anti-slip plates	●
Travel alarm	●
Vandalism protection locks	●
Wide catwalk	●
Radiator and oil cooler dustproof net	●
Emergency engine stop switch: 1 inside cab, 1 LH catwalk, 1 RH deck	●
Hydraulically operated stairway	●
Engine coolant heater	○
Engine oil pan heater	○
Fuel quick charge system	○

Further equipment on request

- standard equipment
- optional equipment

Your Komatsu partner:

KOMATSU

**Komatsu Europe
International N.V.**

Mechelsesteenweg 586
B-1800 VILVOORDE (BELGIUM)
Tel. +32-2-255 24 11
Fax +32-2-252 19 81
www.komatsu.eu

EENSS20363 03/2022

KOMATSU is a trademark of Komatsu Ltd. Japan.