

MARSDEN

USER MANUAL

Patient Transfer Scale

M-999



Version 1.3 06/19

Contents

Introduction	3
Product Specification	3
Safety Instructions	4
Cleaning	5
Explanation of Graphic Symbols	6
LCD Display	7
Wall Mounting the Scale	8
Recharging the Scale	10
Setting up the Scale	11
Preparing to use the Scale	12
Operation: Basic Functions	14
Operation: Advanced Functions	15
EMC Guidance and Manufacturer's Declaration	16
Error Messages	20
Manufacturer's Declaration of Conformity	21

Thank you for purchasing this Marsden Patient Transfer Scale. This is a precision Class III Weighing Instrument and considerate use will result in many years of accurate weighing.

The scale has a maximum load capacity of 250kg which must not be exceeded.

Product Specification

Model	M-999
Accuracy Class	Class III
Capacity/Division	250kg x 0.5kg
Weight of scale	11.4kg
Units of Measure	kg
Function Keys	ON/OFF/ZERO, HOLD
Operating Temperature/Humidity	5 to 35°C / 15 - 85% RH
Power Supply	Rechargeable battery pack
Display	27.7mm x 75mm LCD
Dimensions	1805mm X 700mm X 30mm

Safety Instructions

Before putting the device into use, please read with care the information given in this user manual, which contains important instructions for proper installation, use and maintenance of the device.

Marsden/the manufacturer shall not be liable for damages arising from failure to heed the following instructions:

- When using electrical components under increased safety requirements, always comply with appropriate regulations.
- Inappropriate installation/use will render the warranty null and void.
- Ensure the voltage marked on the power supply unit matches your mains supply.
- This device is designed for use indoors.
- Observe the permissible ambient temperatures for use.
- The device meets the requirements for electromagnetic capability. Do not exceed the maximum values specified in the applicable standards.
- Batteries should be kept away from small children. If swallowed, promptly seek medical assistance.

If you have any problems, contact Marsden/your local dealer/your service partner.

Maintenance

- We recommend checking the scale's accuracy at regular intervals. If any inaccuracies occur, please contact your local dealer or service partner.
- Repairs should be carried out by authorised service agents. For information regarding Marsden service contracts in the UK, call 01709 364296.

Disposing of the Scale

- This product should not be treated as regular household waste, but should be handed in to an electrical/electronic equipment recycling centre.
- You can obtain further details from your local council, your municipal waste disposal company or from where you purchased the product.

Cleaning

When cleaning or disinfecting the Patient Transfer Scale, please follow the guidance below.

- The Patient Transfer Scale must be cleaned after each patient use with a neutral based detergent and water or a detergent wipe. If contaminated with blood or body fluids then disinfect as per local guidelines.
- Use a non-abrasive cloth.
- Please do not use corrosive liquids, large amounts of water or high pressure washers.
- Do not submerge the PTS in water. If you think the scale may have suffered water ingress, stop using it immediately and contact Marsden/your local dealer/your service partner.
- Always disconnect the PTS from the mains power supply before cleaning.

Explanation of Graphic Symbols

SN-21300100



Designation of the serial number of every device.
(Number as an example)

“Please note the accompanying documents” or “Observe operating instructions”



Identification of manufacturer of medical product including address.

Charder Electronic Co. Ltd
No.103 Guozhong Rd, Dali Dist,
Taichung City 412, Taiwan (R.O.C)



Type B applied part



Dispose of old appliances separately from your household waste.
This product must be disposed of at a communal collection point.



Carefully read this operation manual before setup and commissioning, even if you are already familiar with Marsden scales.

LCD Display

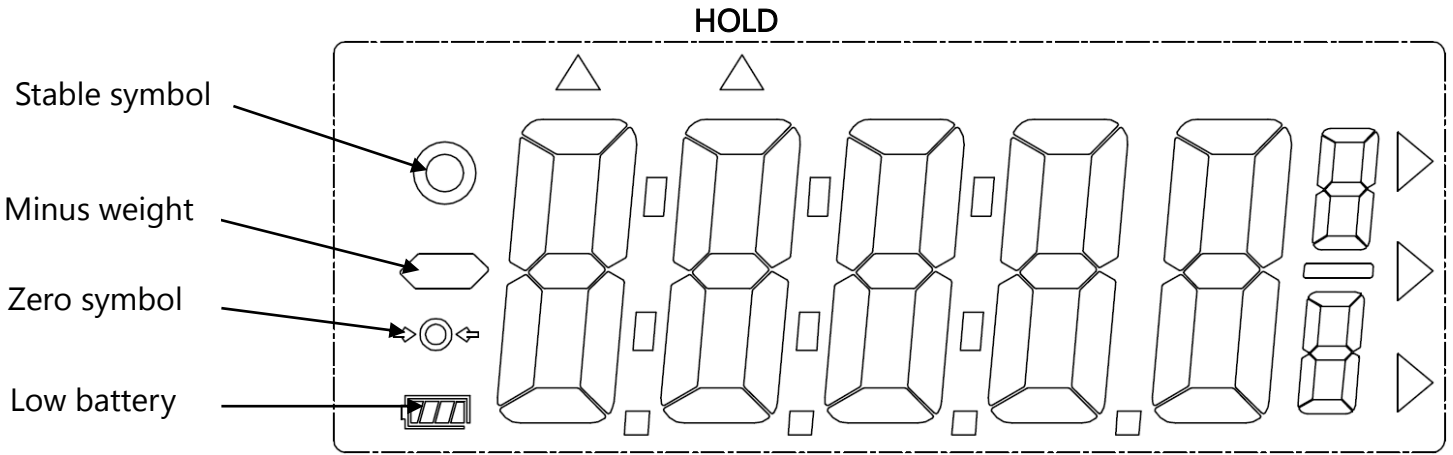

Stable symbol: To indicator the weight reading is stable

Minor weight: The weight is under zero.

Zero symbol: The weight is at zero point.

Low battery: Please recharge the scale.

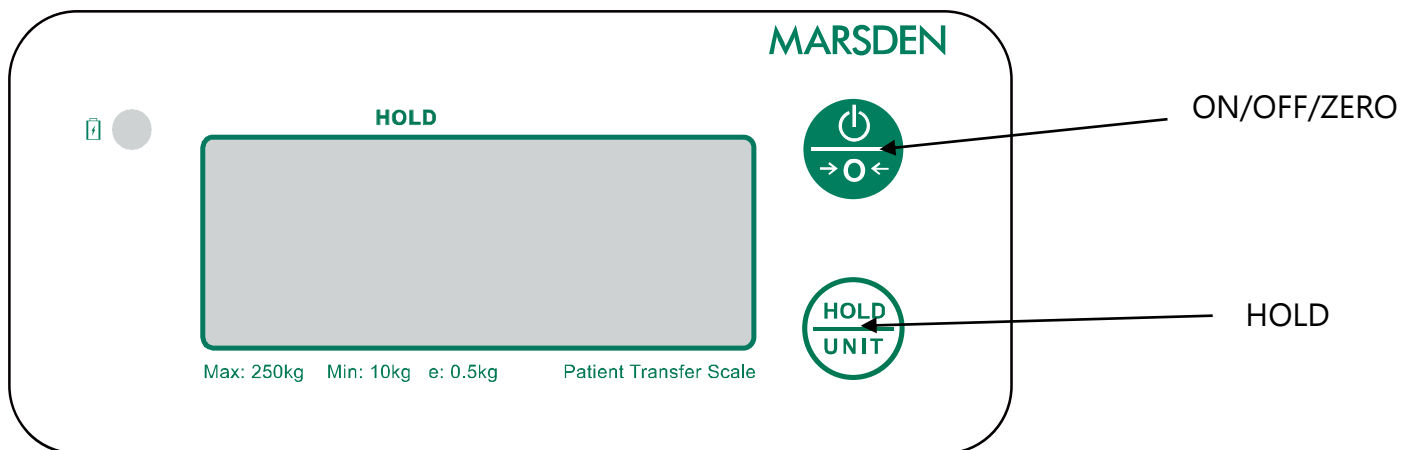

Wall Mounting the Scale

You can hang the Patient Transfer Scale on the wall either horizontally or vertically, using the hooks provided. Your hooks will need to be positioned exactly 1400mm or 610mm apart, centre to centre, depending on orientation.

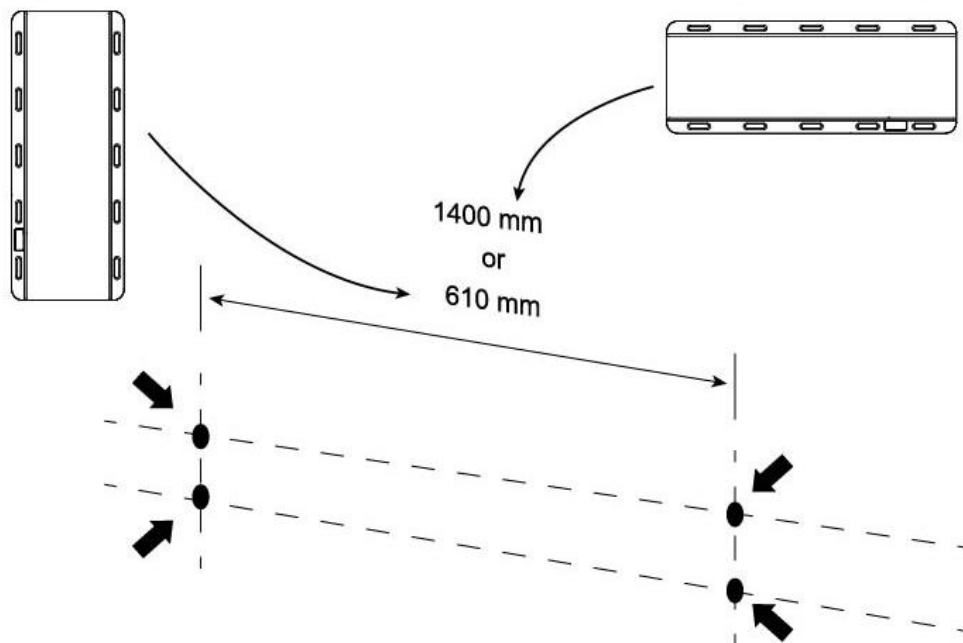

Use the Patient Transfer Scale and the hooks to determine the positioning of the hooks on the wall, and mark drill holes. Drill holes should be exactly 1400mm or 610mm apart, as per above.

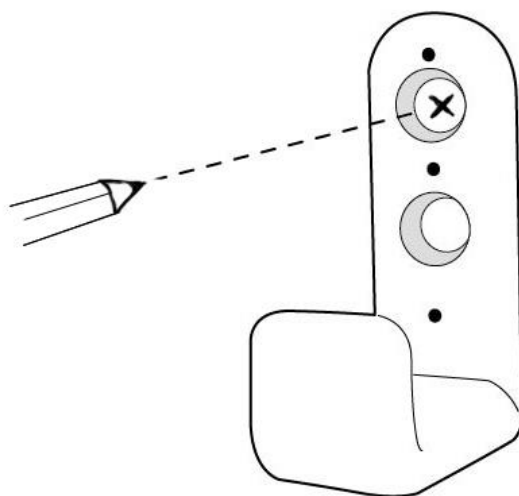

Drill two 6.5mm the holes for each hook.

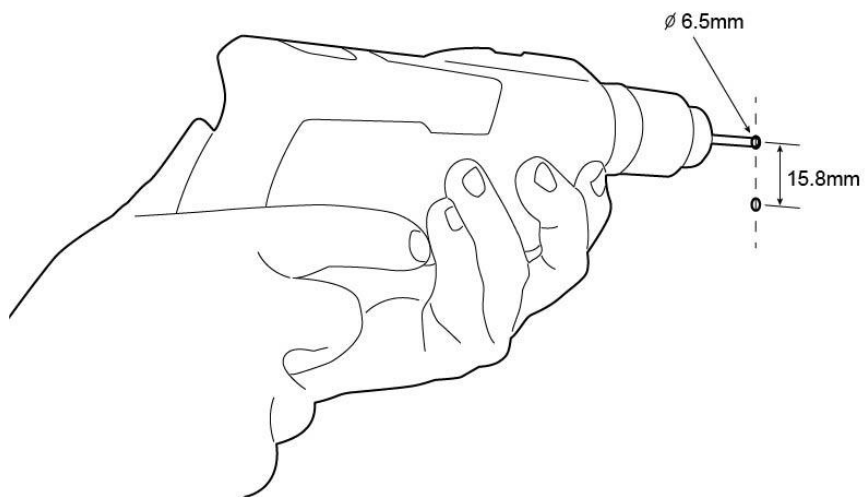

Affix the hooks to the wall using the screws and wall plugs provided, and use the plastic covers to hide the screwheads.

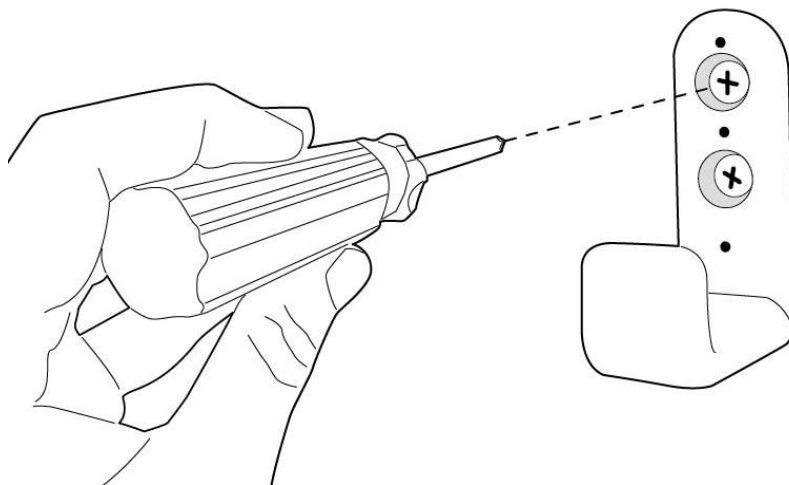

Your Patient Transfer Scale can now be hung on the wall.

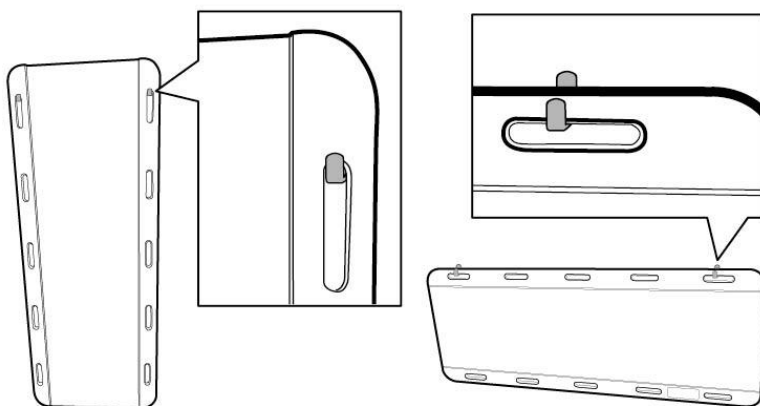

Recharging the Scale

We recommend fully charging the scale before first use. To fully charge the scale please allow 8 hours.

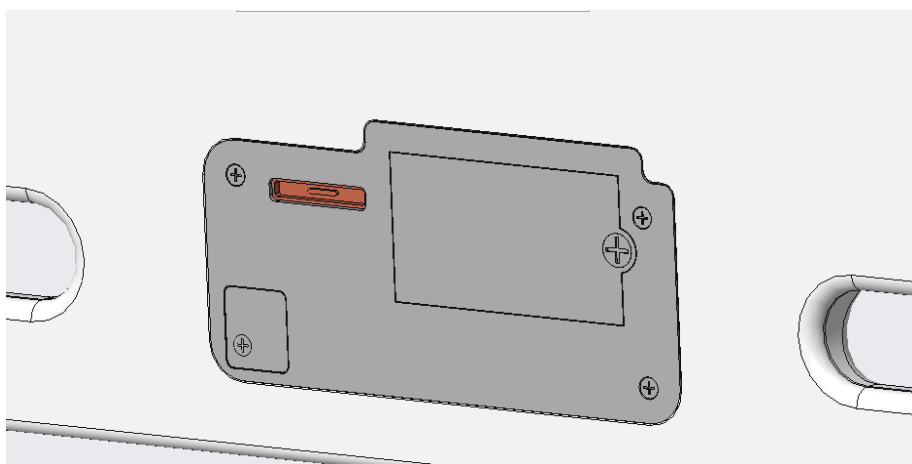
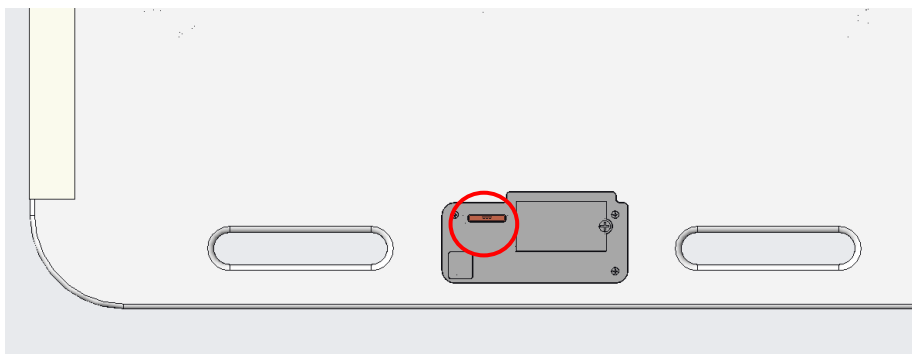

When the low battery indicator on the LCD display indicates that the scale needs recharging, move the M-999 to a location where it can be charged. You will find the charging port on the underside of the scale.

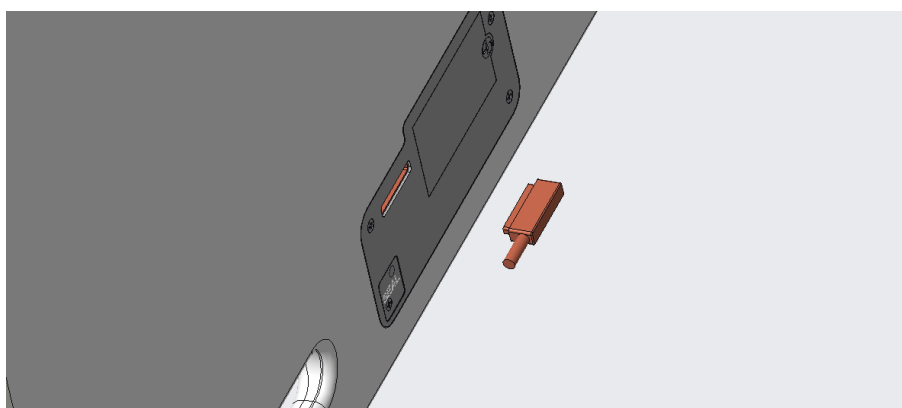

The port for the charging cable is magnetic. Clip the end of the cable in place and plug the other end of the cable into a power socket. Please do not use any form of charging cable other than the one supplied with the scale. The scale cannot be used whilst recharging.

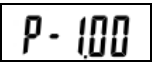

Setting up the Scale

With the scale switched off, press and hold  until the display shows , then press  3 times. You will enter Setup for auto power-off, buzzer and backlight.

Auto off time: 30m/60m/off

Buzzer: On/Off

Backlight: ON/OFF

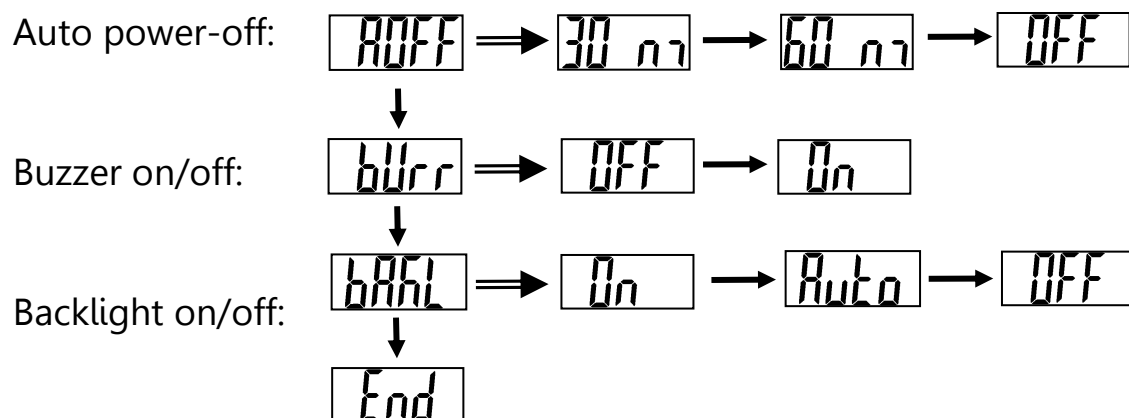

To confirm the settings, please press HOLD/UNIT when

End

shows on the display.

Preparing to use the Scale

The Patient Transfer Scale should be used in line with current moving and handling policies. Essentially, it should be used in the same way you would use a transfer board, taking into account of course that you will need to pause for a few seconds during the transfer process, to allow the scale to capture the patient's weight.

- The Patient Transfer Weighing Scale should only be used by trained professionals.



Ensure brakes on castors are applied before you begin the transfer process.

- Ensure that trolley/bed frames are touching before you start the transfer process.
- There should be no more than 200mm between mattresses. There should also be 200mm or more of the Patient Transfer Scale on each bed or trolley before use.
- When transferring, the two surfaces must be of similar height. A tilt of less than 3% (one side raised by around 25mm) is ok; a tilt greater than this will affect the scale's accuracy. To avoid showing an inaccurate reading, the scale will display an error message if tilt exceeds 3% (see Error Messages).

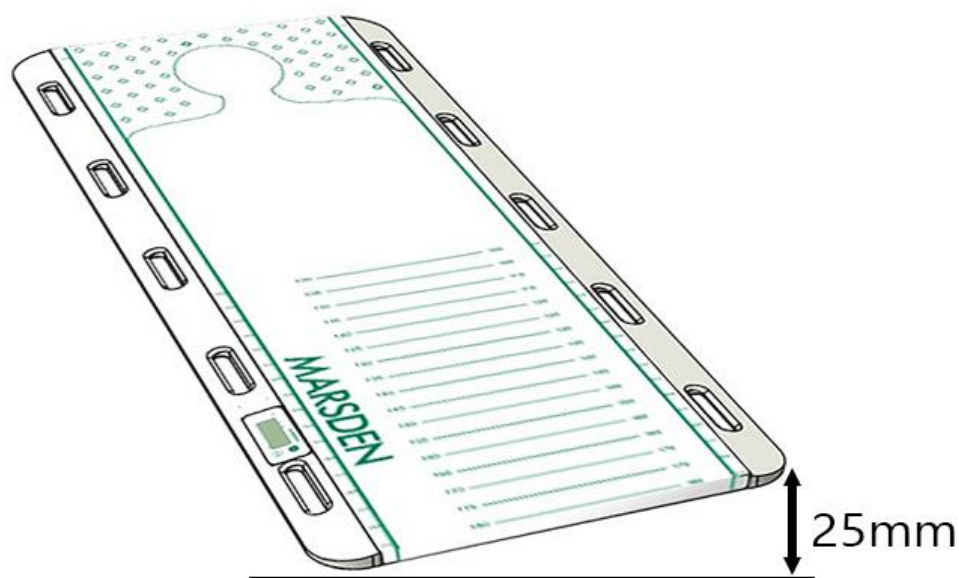

- Guidance for safe use can also be found on the scale itself (see next page).

 **CAUTION**

1. Transfer between surfaces of similar height
2. Check the scale for damage before use
3. Do not overload. Maximum capacity 250kg / 550lbs
4. The wheels of the trolley or bed must be locked before use
5. The distance from bed to bed, or trolley to bed, must be no more than 20cm / 8 inches
6. The Patient Transfer Scale must have a minimum of 20cm / 8 inches on each bed or trolley and bed

Operation: Basic Functions

Switching the Scale on

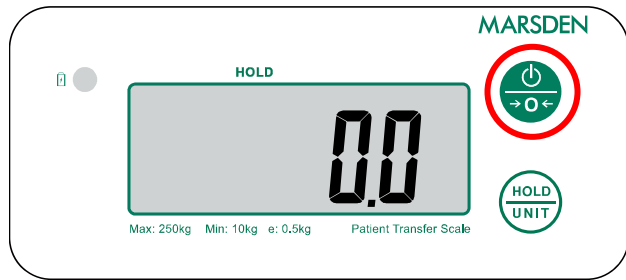

To switch the scale on, press the ON/OFF/ZERO button. When the display shows 0.0 the scale is ready to use.

Switching the Scale off

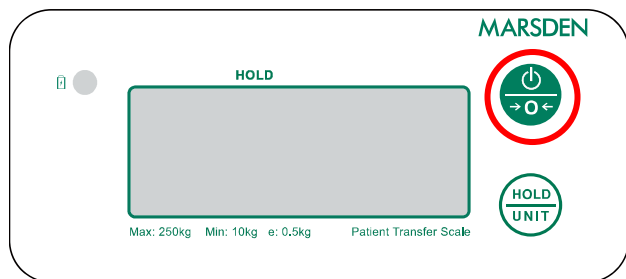

Press and hold ON/OFF/ZERO button for three seconds to power the scale down.

Setting the Scale to Zero

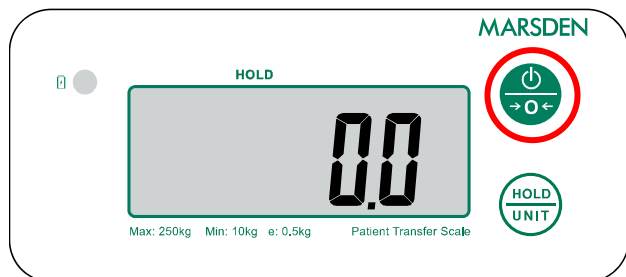

If for any reason the scale shows a reading other than 0.0 it can be reset to zero. Press the ON/OFF/ZERO button once and the scale will return to 0.0.

Operation: Advanced Functions

Using the Hold Function

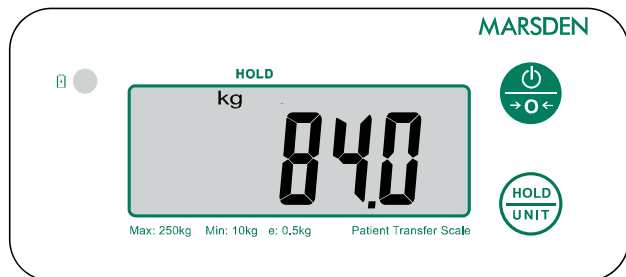

The scale's Hold function stabilises the weight reading on the display, allowing you to take an accurate reading without fluctuations.

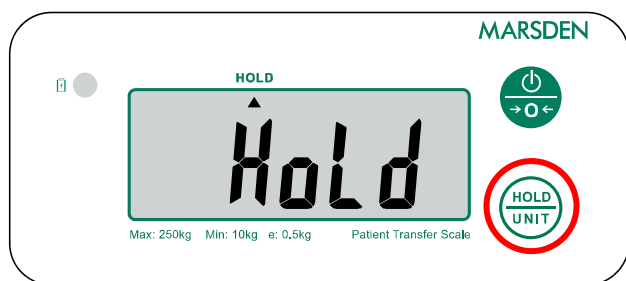

With a patient on the scale, press HOLD/UNIT. The display will show 'HOLD'.
NB: Alternatively, you can activate the Hold function before the patient is on the scale.

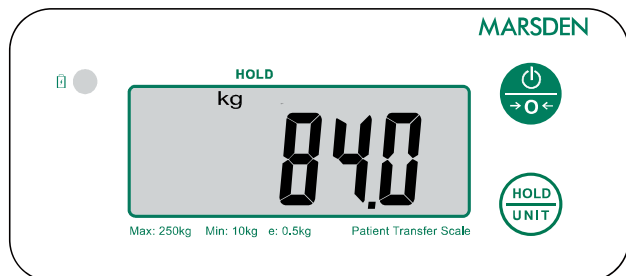

When the scale has determined the weight of the patient, a stable weight reading will show. This will remain on the display after the patient has left the scale.

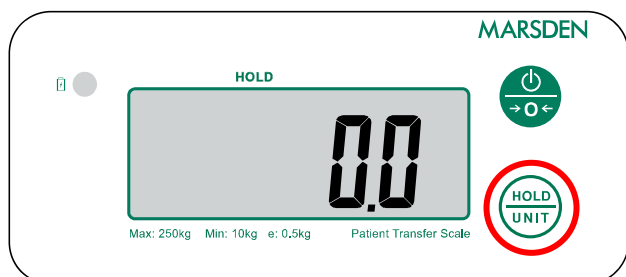

Press HOLD/UNIT to disable the Hold function.

EMC Guidance & Manufacturer's Declaration

Guidance and manufacturer's declaration-electromagnetic emissions		
<p>The MEDICAL SCALE M-999 is intended for use in the electromagnetic environment specified below. The customer or the user of the MEDICAL SCALE should ensure that it is used in such an environment.</p>		
Emission test	Compliance	Electromagnetic environment-guidance
RF emissions CISPR 11	Group 1	The MEDICAL SCALE M-999 uses RF energy only for its internal function. Therefore, its RF emissions are very low and are not likely to cause any interference in nearby electronic equipment.
RF emissions CISPR 11	Class B	The MEDICAL SCALE M-999 is suitable for use in all establishments, including domestic establishments and those directly connected to the public low-voltage power supply network that supplies buildings used for domestic purposes.
Harmonic emissions IEC 61000-3-2	Class A	
Voltage fluctuations /flicker emissions IEC 61000-3-3	Compliance	

Guidance and manufacturer's declaration-electromagnetic immunity			
<p>The MEDICAL SCALE M-999 is intended for use in the electromagnetic environment specified below. The customer or the user of the MEDICAL SCALE M-999 should ensure that it is used in such an environment.</p>			
Immunity test	IEC 60601 test level	Compliance level	Electromagnetic environment-guidance
Electrostatic discharge(ESD) IEC 61000-4-2	± 6 kV contact ± 8 kV air	± 6 kV contact ± 8 kV air	Floors should be wood, concrete or ceramic tile. If floors are covered with synthetic material, the relative humidity should be at least 30%
Electrical fast transient/burst IEC 61000-4-4	± 2kV for power supply lines + 1kV for input/output lines	± 2kV for power supply lines Not applicable	Mains power quality should be that of a typical commercial or hospital environment.

Surge IEC 61000-4-5	± 1kV line(s) to line(s) ± 2kV line(s) to earth	± 1kV differential mode Not applicable	Mains power quality should be that of a typical commercial or hospital environment.
Voltage Dips, short interruptions and voltage variations on power supply input lines IEC 61000-4-11	<5% UT(>95% dip in UT) for 0,5 cycle 40% UT(60% dip in UT) for 5 cycles 70% UT(30% dip in UT) for 25 cycles <5% UT(>95% dip in UT) for 5 s	<5% UT(>95% dip in UT) for 0,5 cycle 40% UT(60% dip in UT) for 5 cycles 70% UT(30% dip in UT) for 25 cycles <5% UT(>95% dip in UT) for 5 s	Mains power quality should be that of a typical commercial or hospital environment. If the user of the MEDICAL SCALE M-999 requires continued operation during power mains interruptions, it is recommended that the MEDICAL SCALE M-999 be powered from an uninterruptible power supply or a battery.
Power frequency(50/60 Hz) magnetic field IEC 61000-4-8	3 A/m	3 A/m	The MEDICAL SCALE M-999 power frequency magnetic fields should be at levels characteristic of a typical location in a typical commercial or hospital environment.
NOTE UT is the a.c. mains voltage prior to application of the test level.			

Guidance and manufacturer's declaration-electromagnetic immunity			
The MEDICAL SCALE M-999 is intended for use in the electromagnetic environment specified below. The customer or the user of the MEDICAL SCALE M-999 should assure that is used in such and environment.			
Immunity test	IEC 60601 test level	Compliance level	Electromagnetic environment-guidance
Conducted RF IEC 61000-4-6	3 Vrms 150 KHz to 80 MHz	3 Vrms	Portable and mobile RF communications equipment should be used no closer to any part of the MEDICAL SCALE M-999 including cables, than the recommended separation distance calculated from the equation applicable to the frequency of the transmitter.

Radiated RF IEC 61000-4-3	3 V/m 80MHz to 2,5 GHz	3 V/m	<p>Recommended separation distance: $d = 1,2 \sqrt{P}$ $d = 1,2 \sqrt{P}$ 80MHz to 800 MHz $d = 2,3 \sqrt{P}$ 800MHz to 2,5 GHz</p> <p>Where P is the maximum output power rating of the transmitter in watts (W) according to the transmitter manufacturer and d is the recommended separation distance in metres (m).</p> <p>Field strengths from fixed RF transmitters, as determined by an electromagnetic site survey^a, should be less than the compliance level in each frequency range^b.</p> <p>Interference may occur in the vicinity of equipment marked with the following symbol:</p> 
NOTE1 At 80 MHz and 800 MHz, the higher frequency range applies.			
NOTE2 These guidelines may not apply in all situations. Electromagnetic propagation is affected by absorption and reflection from structures, objects and people.			
<p>a Field strengths from fixed transmitters, such as base stations for radio (cellular/cordless) telephones and land mobile radios, amateur radio, AM and FM radio broadcast and TV broadcast cannot be predicted theoretically with accuracy. To assess the electromagnetic environment due to fixed RF transmitters, an electromagnetic site survey should be considered. If the measured field strength in the location in which the MEDICAL SCALE M-999 is used exceeds the applicable RF compliance level above, the MEDICAL SCALE M-999 should be observed to verify normal operation. If abnormal performance is observed, additional measures may be necessary, such as re-orienting or relocating the MEDICAL SCALE M-999.</p> <p>b Over the frequency range 150 kHz to 80 MHz, field strengths should be less than 3 V/m.</p>			

Recommended separation distance between portable and mobile RF communications equipment and the MEDICAL SCALE

The MEDICAL SCALE M-999 is intended for use in an electromagnetic environment in which radiated RF disturbances are controlled. The customer or the user of the MEDICAL SCALE M-999 can help prevent electromagnetic interference by maintaining a minimum distance between portable and mobile RF communications equipment (transmitters) and the MEDICAL SCALE as recommended below, according to the maximum output power of the communications equipment.







Rated maximum output power of transmitter W	Separation distance according to frequency of transmitter m		
	150 kHz to 80 MHz $d = 1,2\sqrt{P}$	80 MHz to 800 MHz $d = 1,2\sqrt{P}$	800 MHz to 2,5 GHz $d = 2,3\sqrt{P}$
0,01	0,12	0,12	0,23
0,1	0,38	0,38	0,73
1	1,2	1,2	2,3
10	3,8	3,8	7,3
100	12	12	23

For transmitters rated at a maximum output power not listed above, the recommended separation distance d in metres (m) can be estimated using the equation applicable to the frequency of the transmitter, where p is the maximum output power rating of the transmitter in watts (W) according to the transmitter manufacturer.

NOTE1 At 80 MHz and 800 MHz, the separation distance for the higher frequency range applies.

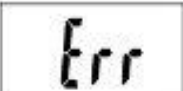
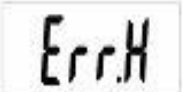
NOTE2 These guidelines may not apply in all situations. Electromagnetic propagation is affected by absorption and reflection from structures, objects and people.

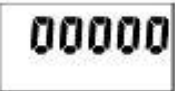
Error Messages

Error Message	Reason	Action
	Tilt error: The scale has been tilted by 3% or more.	Please ensure the scale is as level as possible before use.
	Low battery: This warning shows that the voltage of battery is too low to use	Please recharge the scale.
	Overload: The Total load exceeds the maximum capacity of scale	Please reduce the load on the scale.
	Counting error (too high): Indicates that the signal from the loadcells is too high	This error is normally caused by a serious fault. Please contact your service provider.
	Counting error (too low): Indicates that the signal from the loadcell is too low	This error is normally caused by a serious fault. Please contact your service provider.
	Zero count over calibration zero range (+10% with power on)	Please re-calibrate the scale.
	Zero count under calibration zero range (-10% with power on)	Please re-calibrate the scale.
	EEPROM Error: Indicates that there is a fault with the software	This error is normally caused by a serious fault. Please contact your service provider.

Manufacturer's Declaration of Conformity

Manufacturer's Declaration of Conformity

This product has been manufactured in accordance with the harmonized European standards, following the provisions of the below stated directives:

	93/42/EEC as amended by 2007/47/EC Medical Device Directive
---	---

Please see separate document showing on sticker of device for above CE marking.

Authorized EU Representative:



Manufactured by:





EU Declaration of Conformity

The Non-Automatic Weighing Instrument **III**

Manufacturer	Charder Electronic Co., Ltd
Model	M-999
EC Type Approval Certificate No.	T11452

The Metrological Aspects of Non-Automatic Weighing Instruments

EN45501:2015 (module D)	Notified Body Number – 0126
EN45501:2015 (module B)	Notified Body Number – 0122

The non-automatic weighing instrument corresponds to the production model described in the EC Type Approval Certificate and requirements of the following EC Directives:

2014/31/EU	Non-Automatic Weighing Instruments Directive
93/42/EEC as amended by 2007/47/EC	Medical Device Directive

The applicable harmonized standards are:

EN45501:2015	The Metrological Aspects of Non-Automatic Weighing Machines
EN ISO14971:2012	Medical devices - Application of risk management to medical devices
EN ISO10993-1:2009	Biological evaluation of medical devices - Part 1: Evaluation and testing within a risk management process
EN60601-1:2006	Medical electrical equipment - Part 1: General requirements for basic safety and essential performance
EN60601-1-2:2007	Medical electrical equipment - Part 1-2: General requirements for basic safety and essential performance – Collateral standard: Electromagnetic compatibility - Requirements and tests
EN60601-1-6:2010	Medical electrical equipment - Part 1-6: General requirements for basic safety and essential performance - Collateral standard: Usability
EN62304:2006	Medical device software - Software life-cycle processes
EN980:2008	Symbols for use in the labelling of medical devices

This declaration of conformity is issued under the sole responsibility of the manufacturer.

Date: 2018/11/30

Signature: 

Name: Angela Lu
Position: Measuring Management Rep.
Place: Taichung, Taiwan

Manufacturer: Charder Electronic Co., Ltd.

Address: NO.103, Guozhong Rd., Dali Dist., Taichung City 412, Taiwan (R.O.C.)

CD-QR00139

MARSDEN

Tel: +44 (0) 1709 364296

Fax: +44 (0) 1709 364293

E-mail: sales@marsdengroup.co.uk

Manufacturing and Distribution:

Unit 7, Centurion Business Park,

Coggin Mill Way,

Rotherham,

S60 1FB

Sales, Technical Support, Service & Finance

Unit 1, Genesis Business Park,

Sheffield Road,

Rotherham, UK

S60 1DX

www.marsden-weighing.co.uk

www.patienttransferscale.com