

# eKOMPACT

V E R S A T I L E   T E C H N O L O G Y



# eKOMPACT

Promotal conducted the largest ever survey of medical examination furniture with 200 doctors from 6 European and Middle East countries. This allows us to develop adapted products with a high added value.

eKompact is currently the most suitable height-adjustable examination table for healthcare professionals and their environment. In addition to its sitting position, its storage and integrated retractable stirrups allow you to perform a complete examination on a 1m<sup>3</sup> table. It becomes a real assistant for the patient and the practitioner by adapting to their morphology and preferences thanks to the ability to record favourite positions and its autonomous movements.

WARRANTY  
2 YEARS

LOAD CAPACITY  
UP TO 205 KG

INTEGRATED LEG  
REST EXTENSION  
(AT THE SAME LEVEL  
AS THE SEAT)

INTEGRATED  
RETRACTABLE  
STIRRUPS

ADJUSTABLE HEIGHT  
FROM 48 TO 99.5 CM  
WIDTH: 72 CM

THE TABLE IS  
EQUIPPED WITH:

- 1 "PASS THROUGH" SIDE DRAWER (52X37X9)
- 1 FRONT DRAWER (50X17X7)

## MODELS

40235-01	EKOMPACT STANDARD MODEL
40235-20	EKOMPACT ONE TOUCH MODEL
40235-25	EKOMPACT PREMIUM MODEL (+ ABS SIDE PANEL + WIRELESS PEDAL)
235150-70	SEAMLESS COMFORT UPHOLSTERY*

\* Width 72cm, compatible with all 3 models, to be ordered separately, delivered unassembled.



## **EQUAL TREATMENT**

---

### **MAKE LIFE EASIER FOR YOUR PATIENTS WITH REDUCED MOBILITY WITH:**

- › A seated patient reception position at 48 cm
- › Gentle and safe electrical movements
- › Switching from the exam sitting position to lying down effortlessly thanks to the integrated legrest extension

### **EXAMINE ALL YOUR PATIENTS WITH THE SAME EASE:**

- › Accommodates up to 205 Kg
- › Comfort upholstery - width 72 cm

### **SECURE YOUR EXAMS:**

- › Safety sensors
- › Safety battery



## **EFFICIENCY**

---

### **HAVE EVERYTHING YOU NEED IN 1M<sup>3</sup>:**

- › A gynaecological position with retractable and adjustable stirrups
- › An ABS gynaecological tray (stainless steel option)
- › 2 storage drawers (1 Pass Through Side Drawer & 1 Front Drawer)
- › A large capacity roll holder integrated into the backrest (max length 50cm - diameter 20cm)
- › Seat rails (option)

### **MAKE YOUR EXAMS MORE FLUID THANKS TO:**

- › Autonomous movements, the push of a button is enough to put the seat into position (depending on model)
- › The intuitive control and its pre-set patient reception position
- › Wireless pedal (option)

### **MAKE THE CLEANING OF YOUR TABLE EASY:**

- › Seamless upholstery
- › Removable ABS tray
- › Electrically activatable castors by maintained contact (easy movement of the table - only for cleaning)



## **ERGONOMICS**

---

### **CHANGE POSITIONS EFFORTLESSLY:**

- › All-electric couch: Height, backrest
- › Registration of 3 completely configurable positions

### **WHATEVER YOUR SPECIALITIES**

- › Gynaecologist, general practitioner, paediatrician

# eKOMPACT

- OPTIONS
- ACCESSORIES

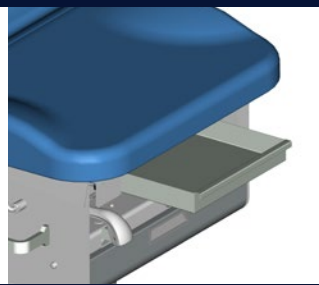
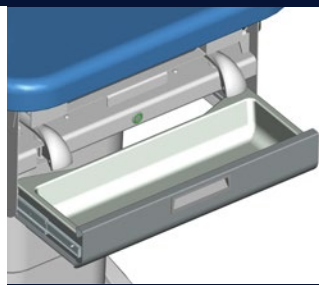
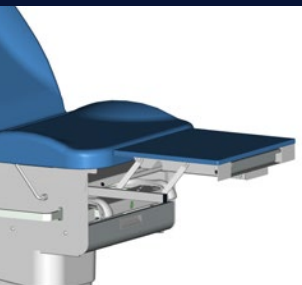

**REF. 272-01**  
ADJUSTABLE FLUSH  
LEG REST

**REF. 278-01**  
PAIR OF RAILS  
25X10MM

**REF. 40996-01**  
WARMING DRAWER

**REF. 4051-20**  
WIRELESS PEDAL

**REF. 40966-01**  
STAINLESS STEEL TRAY  
(REPLACING THE STD TRAY)



**REF. 12851-01**  
PAIR OF STRAPS  
FOR GOEPEL LEG  
SUPPORTS

**REF. 40400-1 EU/UK/US**  
**REF. 40400-2 DK/IT/AUS/CH**  
INTEGRATED MAINS SOCKET  
AND EQUIPOTENTIAL BONDING

**REF. 878-12**  
SLIDING VICE FOR  
RAIL 25X10 mm,  
Ø 16/18 mm

**REF. 879-10**  
ROTARY VICE FOR  
RAIL 25x10 mm

**REF. 236-01**  
ARM SUPPORT  
(+ 878-12)

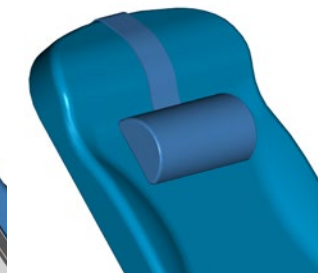
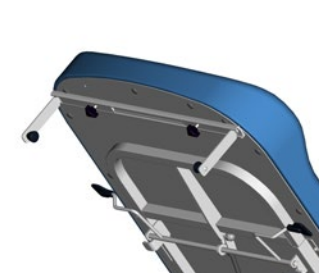

**REF. 2537**  
ARM SUPPORT COVER

**REF. 245-01**  
PAIR OF GOEPELS  
(+ 2x 878-12)

**REF. 2056-02**  
ADJUSTABLE ROLL  
HOLDER  
(350-800 mm)

**REF. 11679-01**  
HEADREST

**REF. 2985-01**  
SELF-TIGHTENING DRIP  
STAND W/ 2 HOOKS  
(+ 878-12)



**REF. 985-01**  
DRIP STAND  
W/ 2 HOOKS  
(+ 878-12)

**REF. 295-01**  
LAMP SUPPORT LID  
FOR RAIL\* 25X10 MM

**REF. 295-10**  
WELCH-ALLYN  
LAMP HOLDER

**REF. 40RVS100L**  
RVS100  
LEFT BRACKET

**REF. 40RVS100R**  
RVS100  
RIGHT BRACKET

**MODEL**  
40235-01 / 40235-20 / 40235-25

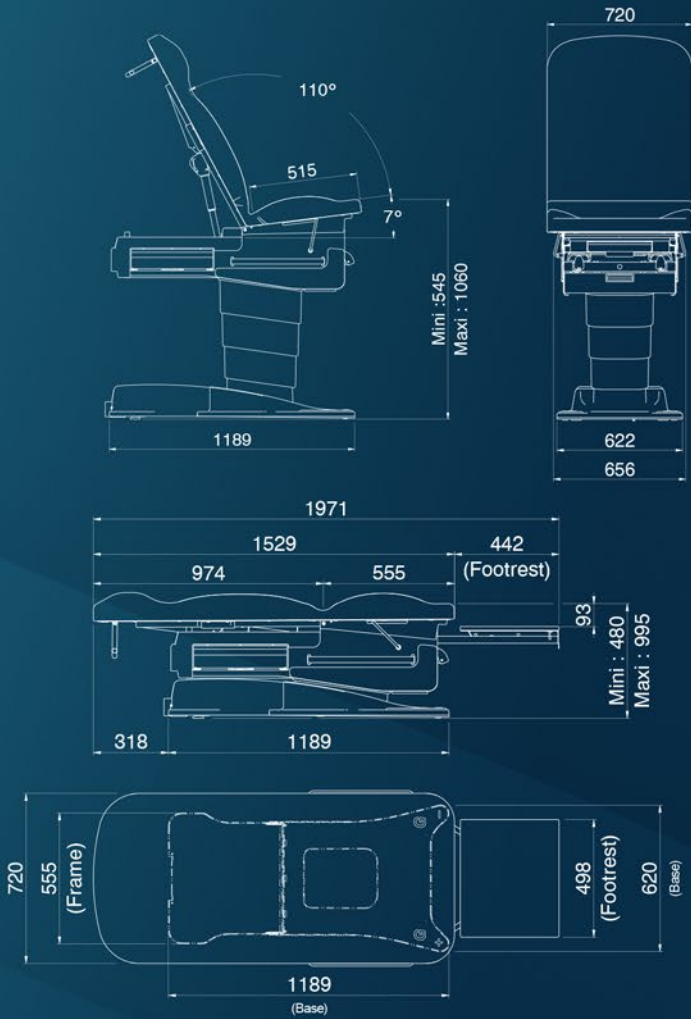

**MODEL**  
40235-01 / 40235-20 / 40235-25 + Option 272-01

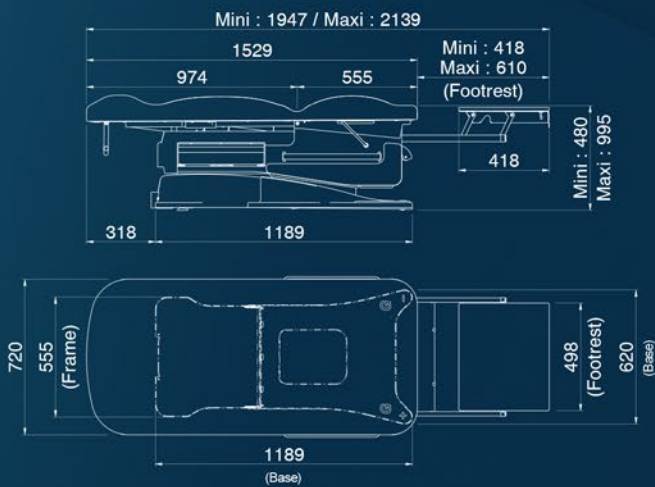

**NET WEIGHT**  
COUCH : 187 kg  
UPHOLSTERY : 12 kg

**GROSS WEIGHT**  
COUCH : 220 kg  
UPHOLSTERY : 16 kg

**PACKAGE VOLUME**  
COUCH : 0,70 m<sup>3</sup>  
UPHOLSTERY : 0,16 m<sup>3</sup>

**UPHOLSTERY COLORS**

- |                    |  |                |
|--------------------|--|----------------|
| CA - TOMATO        |  | CLASSIC RANGE  |
| CB - FUCHSIA       |  |                |
| CC - PLUM          |  |                |
| CD - LEMON         |  |                |
| CE - PEACOCK       |  |                |
| CF - SAPHYR        |  |                |
| CG - MIDNIGHT BLUE |  |                |
| CH - GLACIER       |  |                |
| CI - DARK          |  |                |
| 57 - ANTISTATIC    |  |                |
| CJ - GREY          |  | ELEGANT RANGE* |
| CK - PLATINUM      |  |                |
| EA - DEEP GREEN    |  |                |
| EB - VEGETAL       |  |                |
| EC - STORM         |  |                |
| ED - SILVER BLUE   |  |                |
| EE - PAPRIKA       |  |                |
| EF - TWILIGHT      |  |                |
| EG - CAMEL         |  |                |
| EH - CORK          |  |                |

\* The Elegance range is subject to the application of a price supplement. Please refer to the price list.

NOMADE: lagencenomade@gmail.com

# ELKOMPACT



22 rue de Saint-Denis-de-Gastines - 53500 Ernée, FRANCE  
Phone: + 33 (0)2 43 05 17 76



**PROMOTAL.COM**