

 **ARMTEC** MANIPULATORS
Lift Assist Devices for Materials Handling

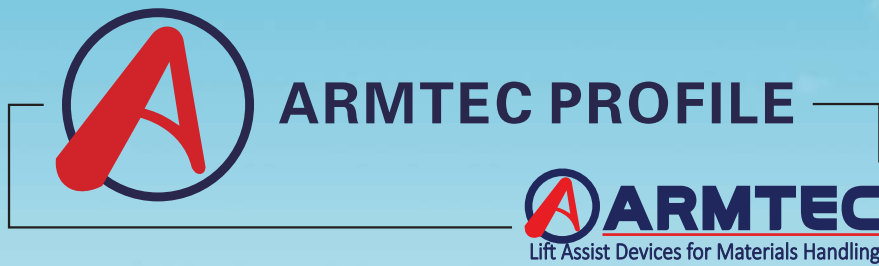



ARMTEC designs and manufactures a specialized range of Lift Assist Devices (Industrial Manipulators - Vertical Arms - Balancing Arms) as well as other selected Materials Handling Equipment.

All ARMTEC equipment comes with a 5 Point Performance Guarantee



◆ Safety:

Meets International Standards of Health and Safety



◆ Certified:

Component parts meet international certification standards to ensure trouble free operation.



◆ Quality:

High Quality Design and Manufacture



◆ Factory Tested:

All equipment is factory tested in simulated conditions to ensure guaranteed performance on site



◆ Long Lasting:

High Reliability and Durability.

COMPANY PROFILE



ARMTEC EQUIPMENT is an Australian company . It was established to meet the growing demand for Pneumatic Industrial Manipulators and other Zero Gravity Lift Assist Devices to address the increasing world-wide concern for the health and safety of workers in Manufacturing.

Our Mission is to supply Pneumatic Manipulators and other Lift Assist Devices to solve repetitive handling problem, satisfy all the requirements of international Corporations (ergonomic, safe, easy to use, reliable and durable) and do this at a lower cost, with greater local content and faster delivery.

To achieve the we set up our Assembly Plant in China to take advantage of the lower cost base there and the larger market share. All our equipment is designed and manufactured to BS EN ISO 12100:2010 Standards and to comply with European 2006/42/EC Machinery Safety Directive (MD). All designs, manufacturing and assembly are to Armtec specifications and under Armtec supervision and quality control, CE certified.

Armtec equipment is sold internationally through Local Partners.

Armtec is always ready to assist!



Cable Arm Manipulator

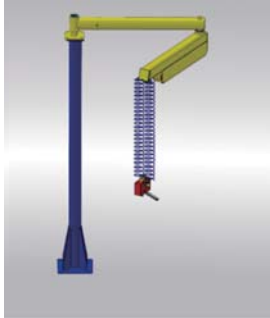

Column Mounted

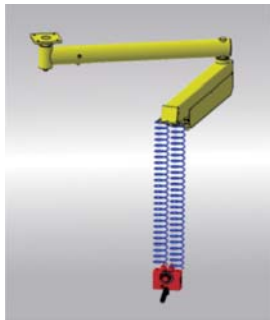

Fixed Overhead Mounted

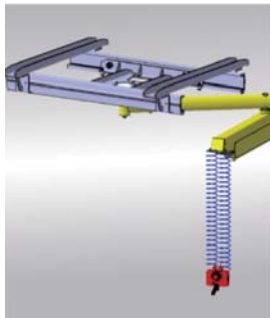

Mobile Overhead Mounted



With Moveable Baseplate

Rigid Arm Manipulator

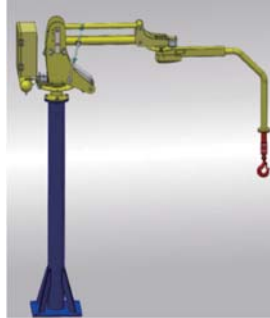

Column Mounted



Fixed Overhead Mounted



Mobile Overhead Mounted



With Moveable Baseplate

Special Order Equipment



Roll Handler



Vertical Manipulator VA100



Jib Arm Integrated with Knight Air Balancer



Vertical Lifting Manipulator

 More configurations can be tailored according to customer needs and technology assessment.

Manipulator Features



Low friction Pneumatic Cylinder, built in accordance with the highest industry standard and undergo a rigorous test.



Integrated Control Box allow for pneumatic circuit check and parts replacement.

Ease of Use:

The Armtec pneumatic manipulator unique "load" and "no load" balancing effect allow the operator control directly proportional to his or her movements. This balancing gives the weightless "floating" condition that enables the operator to move the manipulator with or without a load in all directions around the work area with minimum effort. This combination of the balancing or weightless effect together with the direct operator control allows for the easy picking, manoeuvring and positioning of objects.



Up/down Brake will prevent up down/movement if operator needs to take his hands off the controls or when parked after a shift.



Weight Pre-selector will allow the quick and easy selection of different predictable weights.



Rotation Brake will prevent the manipulator from rotating around its principal vertical axis and the rotating joint located between parallelogram and terminal arm.



Tooling Axis Brake will allow the operator to keep the tooling and manipulator in a fixed position without being held.

- ▲ Competitively Priced
- ▲ "Load" and "No Load" Balancing
- ▲ Ergonomic
- ▲ Safe
- ▲ Reliable
- ▲ Durable



Armtec uses its own proprietary parts or uses pneumatic components supplied by quality companies who have representation worldwide. (SMC, Norgren, Festo etc). Parts can be purchased direct from the supplier or through your Posilift representative.

FEM and Car Body Sides

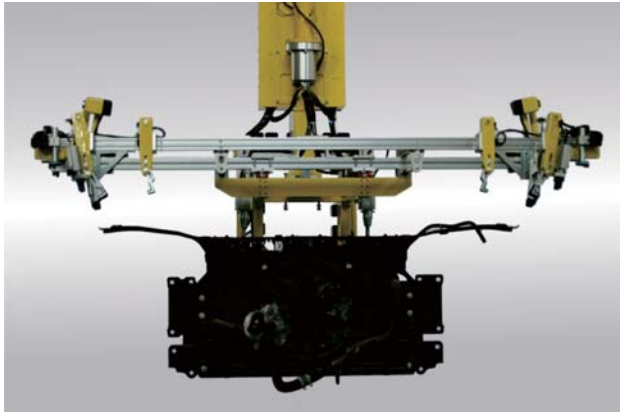

RA100 -Car Body Sides

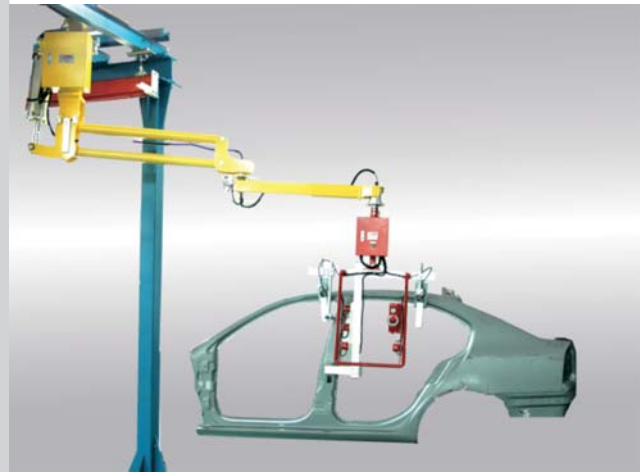

End effector tooling with pneumatic inclination to handle FEM for placement onto the vehicle with load sensor.

Fixed Overhead Rigid Arm Manipulator
Product Weight : 50kg

Panoramic Roof (Car Glass Roof)



■ **Column Mounted Rigid Arm Manipulator
RA200 - Car glass roof**

Venturi Suction cup Tooling with pneumatic rotation
Product Weight: 50kg





Cradles and Rear Axles

□ Jib Arm Integrated with Knight Air Balancer with End Effector Tooling for handling Cradles

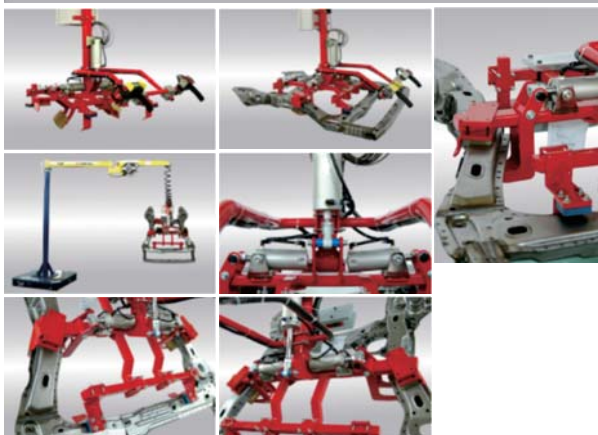

□ End effector tooling for handling Rear Axles

Doors and Tailgates

- RA100 - Suction cups tooling with load sensor for handling car doors



- Tailgate tooling with pneumatic inclination



Tyres



□ RA200 - Tyres
Jaws for gripping on sides



□ RA200 - Tyres
Mandrel tooling with
pneumatic inclination



Seats

- Mobile Overhead Rigid Arm manipulator RA100 for handling seats



- BA 100 with Paddle tooling to handle seats



- RA200 - Paddle tooling for handling seats



Stators

- RA200 - Stators
Mandrel tooling with pneumatic inclination

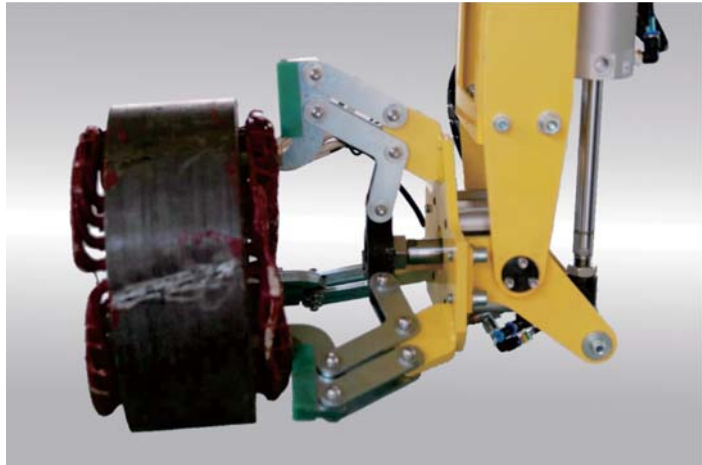

Product Weight : 100kg

Carton Boxes

- RA100 - Adjustable Suction Cups Tooling
 - Horizontal Handling
 - Venturi Vacuum



Rolls

- RA200 - Mandrel tooling with pneumatic inclination for handling Paper Rolls



- RA200 - Gripping jaws for handling rolls of film
 - Product Weight : 200kg

Draught Fans and Stators



■ **RA200 – Draught Fans**

The weightless and effortless lifting for draught fan with 180° turnover function.

■ **RA200 - Stator - Mandrel tooling with pneumatic inclination to handle stators**

Product Weight : 80kg

Operation:

- Take the stator from container
- incline 90° pneumatically
- release the stator onto the assembly line





Sand Moulds

- RA200 - Mandrel tooling for handling Sand Moulds



Metal Bars



■ RA200 - Pneumatic Gripper

Jaws for gripping on sides with High and Low Controls enables the operator to pick or place the product from a comfortable heights without bending or stretching.

Bags

- RA200 with Vacuum Generator tooling for handling bags



Weight Capacity: 15-50kg
 Supply: 7 Bar, clean & dry compressed air and 415V
 3 Phase 50HZ Electricity

Drums, Pails and Plastic Containers

Stainless steel gripper for emptying of drums



- Single suction cup for gripping on the top lid of drum
- Cable Balancing Manipulator with hook to handle Pails

Tyre Rims

- Rigid Arm Manipulator RA200 with gripping jaws for tyre rims



A set of pneumatically actuated gripping jaws to grip the 2 sides of the rim, allow for manually 90° rotation.

Sub-adjust handle covered Asbestos-free material to prevent high temperature up to 400 degree.

Metal Reels

- Fixed Over head mounted Rigid Arm Manipulator RA200 with gripper to handle Metal Reels

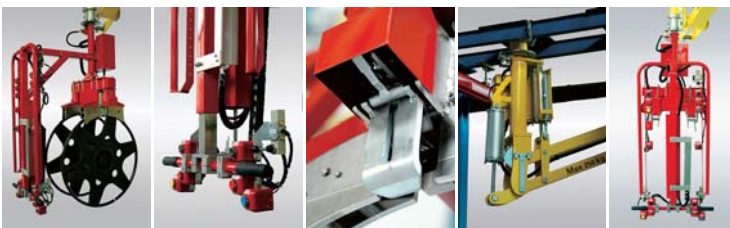

Gripper tooling with Pneumatic Telescopic Handgrip allows the operator to grip or place from the floor or pallet to above a comfortable reach height.

Transformer Sets and Piping Rolls



■ RA200 - Piping Rolls



■ RA200 - Transformer Sets

Gripping jaws with pneumatic rotation



Roll Handlers



- Electric driven trolley with Armtec lift assist device with pneumatic rotation for handling rolls

Weight Capacity up to 600kg

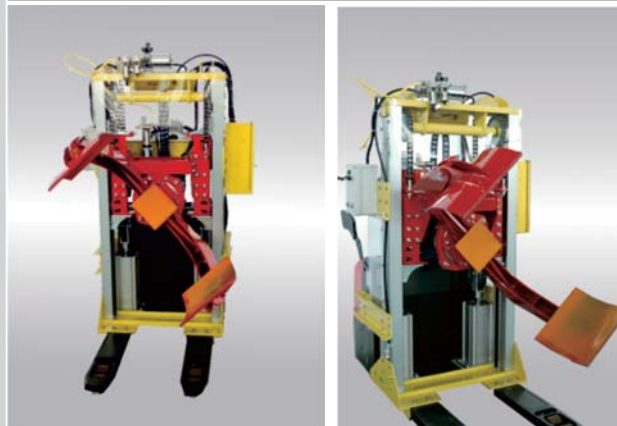

- Floor trolley mobile running roll handler

with mandrel tooling and pneumatic inclination

Weight Capacity up to 500kg





Jib Arm and Vertical Manipulator

Jib Arm Integrated with Knight Air Balancer



Vertical Manipulator

The VA100 is a Vertical Up Down Cylinder Manipulator / Lift Assist Device with an Articulated Arm for positioning the load.



Vertical Lift Assist Devices

Using up / down cylinders or using Knight air balancers.

CUSTOMER LIST



These and many more





Armtec Equipment Pty. Ltd.

Assembly Plant and Administration

Building 4, No. 199, Luji Road, Luyuan Industrial Park, Liuzao Town,
Pudong New Area, Shanghai 201322, P.R.China

Phone: + 86 21 5860 1869 Fax: + 86 21 5860 2152

Email: sales@armtec.com.au

Web: www.armtec.com.au

Web:www.posilift.com.cn

Australian Office

Suite 1A, Level 2, 802 Pacific Highway
Gordon NSW 2072 Australia

Phone: + 61 2 8520 3800 Fax: + 61 2 8520 3290

Email: sales@armtec.com.au

Web: www.armtec.com.au

Web:www.posilift.com.au

**Armtec Equipment is sold internationally through Local Partners.
Please contact us for the name of a Local Partner near you.**

