



100%
MADE IN ITALY



LINDHAUS®

QUALITY CLEANING EQUIPMENT

PROFESSIONAL LINE



LW44 FLEXY HYBRID
LW52 FLEXY HYBRID



LW44-LW52 Flexy Hybrid

Professional battery-powered floor scrubber driers: dynamic washing and excellent drying.



STRENGTHS

- Design, technology and construction 100% made in Italy
- Can be used with battery or current inverter
- High efficiency Rotafil brushless suction motors
- 2 self-cooling Rotafil gearmotors
- Easy to handle and light, just drive them, they go by themselves!
- Flexy joint free or lockable in any position
- Removable solution tank mounted on the body frame
- Recovery tank with Hepa filter integrated in the base
- 36V-20Ah lithium-ion battery for 90 minutes of autonomy
- The base is the lowest on the market (219 mm)
- Hourly output above average (1600 to 2000 m²/h)
- Front and wall washing and drying
- Steering nozzle for perfect drying even in curves
- Immediate replacement of brushes and squeegee (in antibacterial polyurethane) without tools
- It folds up on itself for transport even in a car
- Very low weight and noise level



High tech innovation

EVERYTHING UNDER CONTROL

Thanks to the display on the handle, it is possible, simply by stretching a finger, to **manage all the functions of the machine**, set them according to your needs and check the battery charge level.

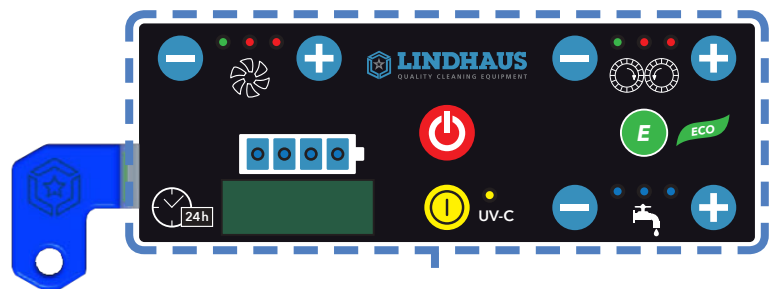

POWERFUL 720Wh LINDHAUS BATTERY

The machine is equipped with a powerful 36V-20Ah lithium-ion battery which allows an autonomy of **90 minutes**; the powerful **Lindhaus** charger allows it to be fully recharged in just **200 minutes**.

HYBRID WITH INVERTER (optional): **Lindhaus** has developed a powerful, self-ventilated **inverter** of the same size as the battery. It is equipped with a 12.5 m cable and makes the machine usable without interruptions.

HIGH EFFICIENCY MOTORS

The high efficiency 36VDC-300W **Rotafil** single-stage **By-Pass Brushless** suction motor, produced by the subsidiary Rotafil in Padua, has 3 speeds to obtain 200, 250 and 300 Watts of power. Despite the **very low consumption**, its performance is **amazing** even at the minimum speed. The two self-ventilated gear motors are also built by the subsidiary Rotafil and thanks to the careful study of every detail, from the magnetic lamination to the gears, to the high reduction ratio, they provide high torque with low consumption and extremely low operating temperatures.

MAINTENANCE WITHOUT TOOLS

The floor squeegee nozzle is **steered** to vacuum perfectly even when turning and **can be removed without tools**. The squeegees can be rotated to be used on all four sides and contribute to the maximum reduction of operating costs.

The machine is equipped with two counter-rotating brushes projecting both laterally and frontally for washing up to the wall.

The brushes are easily replaced thanks to their **quick bayonet coupling**.

Emptying and washing the recovery tank and replacing the **Hepa H11** washable filter are very simple operations thanks to the easy opening of the tank.

UV-C LAMPS TO SANITIZE FRESHLY WASHED FLOORS

The electronic board with **9 UV-C LED lamps** (optional) is easily installed by removing the transparent PC plate under the machine and connecting it to the appropriate connector already present on all machines. The **UV-C** lamps, which do not produce ozone, emit ultraviolet light at a wavelength of 270-280 nm and have the function of inactivating **viruses, bacteria and fungi**, preventing their proliferation.

REMOVABLE TANKS

- The solution tank is hooked directly on the body frame and equipped with a dosing cap.
- The recovery tank, mounted on the base, is equipped with a float and **Hepa H11** motor protection filter. The washable Hepa filter is treated with the **bactericidal-virucidal product I-Protec** to eliminate bacteria, fungi and viruses.
- The **Flexy** joint allows the body frame to **rotate 360°** and lock in the desired position with a single lever, making it adaptable to the needs and height of any operator. It also allows easy access under tables and low furniture and allows the machine to be folded to be transported even in a car.

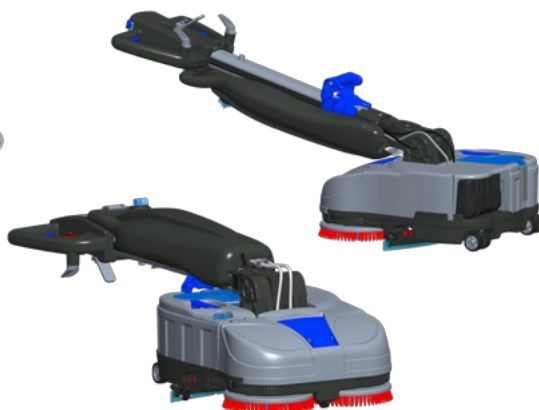
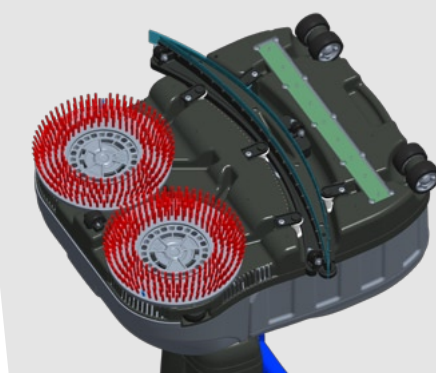
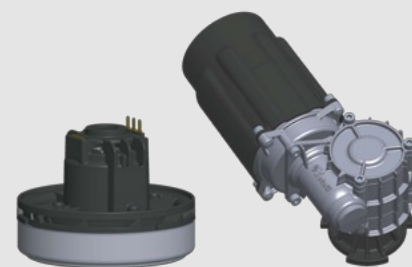

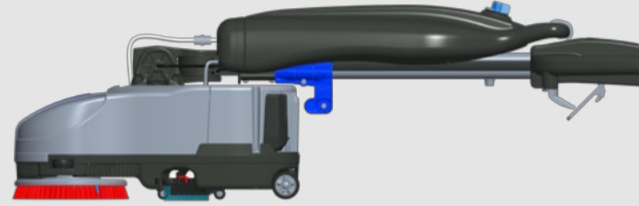
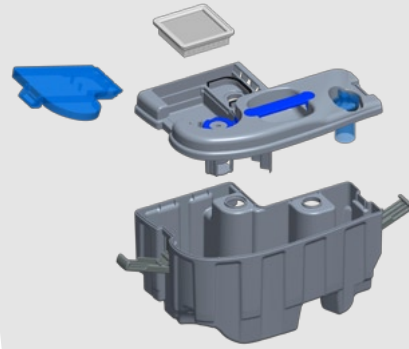
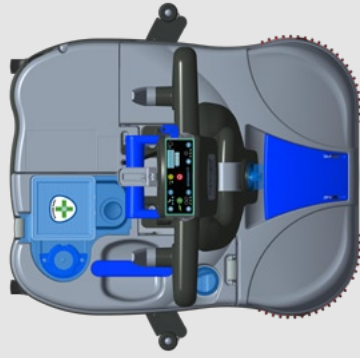

TECHNICAL SPECIFICATIONS

| | LW44 Flexy | LW52 Flexy |
|--|-------------------------------|-------------------------------|
| Working width - vacuum mm (in) | 540 (21.3) | 540 (21.3) |
| Working width - brush mm (in) | 440 (17.3) | 520 (20.5) |
| Working capacity apx. 1 m/s x ww brush sqm/h (sqft/h) | 1600 (17222) | 2000 (21528) |
| Solution tank capacity (lt.) | 6 | 6 |
| Recovery tank capacity (lt.) | 6 | 6 |
| Brush rotation speed (RPM) | 200-250-300 | 150-200-250 |
| Base height mm (in) | 219 (8.6) | 219 (8.6) |
| Weight on handle kg (lb) | 0-3 (0-6.6) | 0-3 (0-6.6) |
| Supply voltage (V) | 36 | 36 |
| Input power (W) | 600 | 600 |
| Rotafil high-efficiency brushless by-pass vacuum motor (W) | 200-250-300 | 200-250-300 |
| Air flow lt./sec. (CFM) | 35 (74.1) | 35 (74.1) |
| Inverter with power cord 12.5 m (41.7 ft) length | Optional | Optional |
| Rotafil gearmotors brushes | 2x150 | 2x150 |
| Brushes pressure (empty) kg (lb) | 25 (55.1) | 26 (57.3) |
| Battery charger (V/Hz) | 220-240/50-60 | 220-240/50-60 |
| Battery (V/Ah) | 36/20 | 36/20 |
| Run-time (ecomode) (min.) | 90 | 90 |
| Battery recharging time (min.) | 200 | 200 |
| LED bar with 9 UV-C lamps | Optional | Optional |
| Overload electronic control | Standard | Standard |
| Variable flow of water | 3 levels | 3 levels |
| Protection class | IPX 4 | IPX 4 |
| Noise level (dbA) | 68 | 68 |
| Total weight with battery kg (lb) | 26 (57.3) | 28 (61.7) |
| Dimensions mm (in) | 444x550x1250 (17.5x21.7x49.2) | 524x570x1250 (20.6x22.4x49.2) |



HEADQUARTERS • LINDHAUS SRL
Via Belgio, 22 Z.I. 35127 • Padova, ITALY
tel. +39 049 8700307 • fax +39 049 8700605
vacuum@lindhaus.it • www.lindhaus.it

LINDHAUS USA
Minneapolis • Minnesota USA
tel. 800 498 7526 • Fax 952 707 1134
info@lindhaus.com • www.lindhaususa.com

DEALER STAMP

The company Lindhaus srl reserves its right to make any modification without prior notice.