

Our strength is your freedom

# autochair

Scooter and wheelchair hoists

Person Lifts



Product catalogue

**MOBILITYCARE**  
*Since 1992*

Phone: (03) 9568 8383

39 Cambro Road, Clayton VIC 3168

[info@mobilitycare.net.au](mailto:info@mobilitycare.net.au)

[www.mobilitycare.net.au](http://www.mobilitycare.net.au)



**autochair**  
Innovating Vehicle Adaptations since 1983





autoch

The logo for Autochair, featuring the word "air" in a blue, lowercase, sans-serif font. The "a" is partially cut off on the left edge of the page.

# Contents

## About us

<b>Welcome to Autochair</b>	4
<b>Design</b>	6
<b>Manufacturing</b>	8
<b>Load testing</b>	12
<b>Fitting</b>	14

## Our products

<b>The Olympian</b>	16
How The Olympian works	18
Versatility of The Olympian	20
<b>The Mini Hoist</b>	22
How the Mini Hoist works	24
<b>The Milford</b>	26
How The Milford works	28
<b>The Milford SmartBase</b>	30



## Welcome to Autochair

Born from one man's desire for greater independence, Autochair is a world leading supplier of vehicle adaptation products and has been making a difference to the lives of tens of thousands of people for more than 30 years.

“

Every one of our products is tested to the limit to ensure that they deliver the kind of performance you can rely on.

”





## The Autochair story

Confined to a wheelchair following an accident in 1975, engineer David Walker's determination to live an independent life led him to invent a device allowing him to load his wheelchair onto his car unaided. When friends asked for one too, David put his innovation into production – and Autochair was born. Still owned and run by the Walker family, Autochair designs and manufactures a wide range of high quality vehicle adaptations, from supremely versatile person lifts to the most powerful scooter and wheelchair hoists on the market.

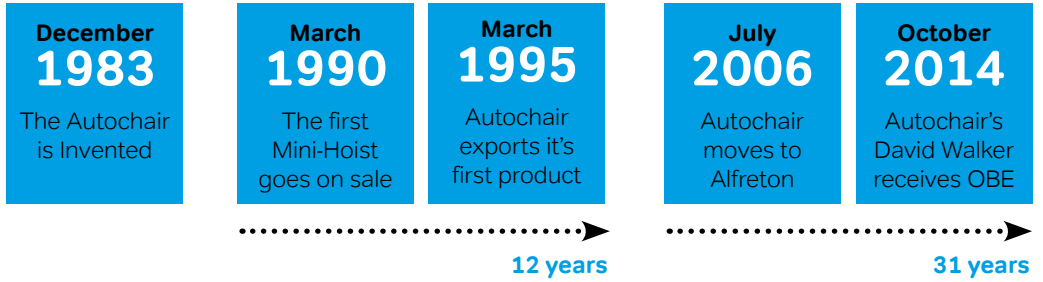

Autochair through the years



## Autochair...by royal appointment

It was a proud day for everyone at Autochair when our founder, David Walker, received an OBE from the Queen in October 2014 in recognition of his services to people with disabilities.

Confined to a wheelchair following an accident in 1975, David invented a way of loading and unloading his wheelchair into his car so that he could enjoy the benefits of independent travel.

His invention led him to start Autochair in 1983 and our ever-growing range of products have helped many thousands of people just like David, regain their independence ever since.

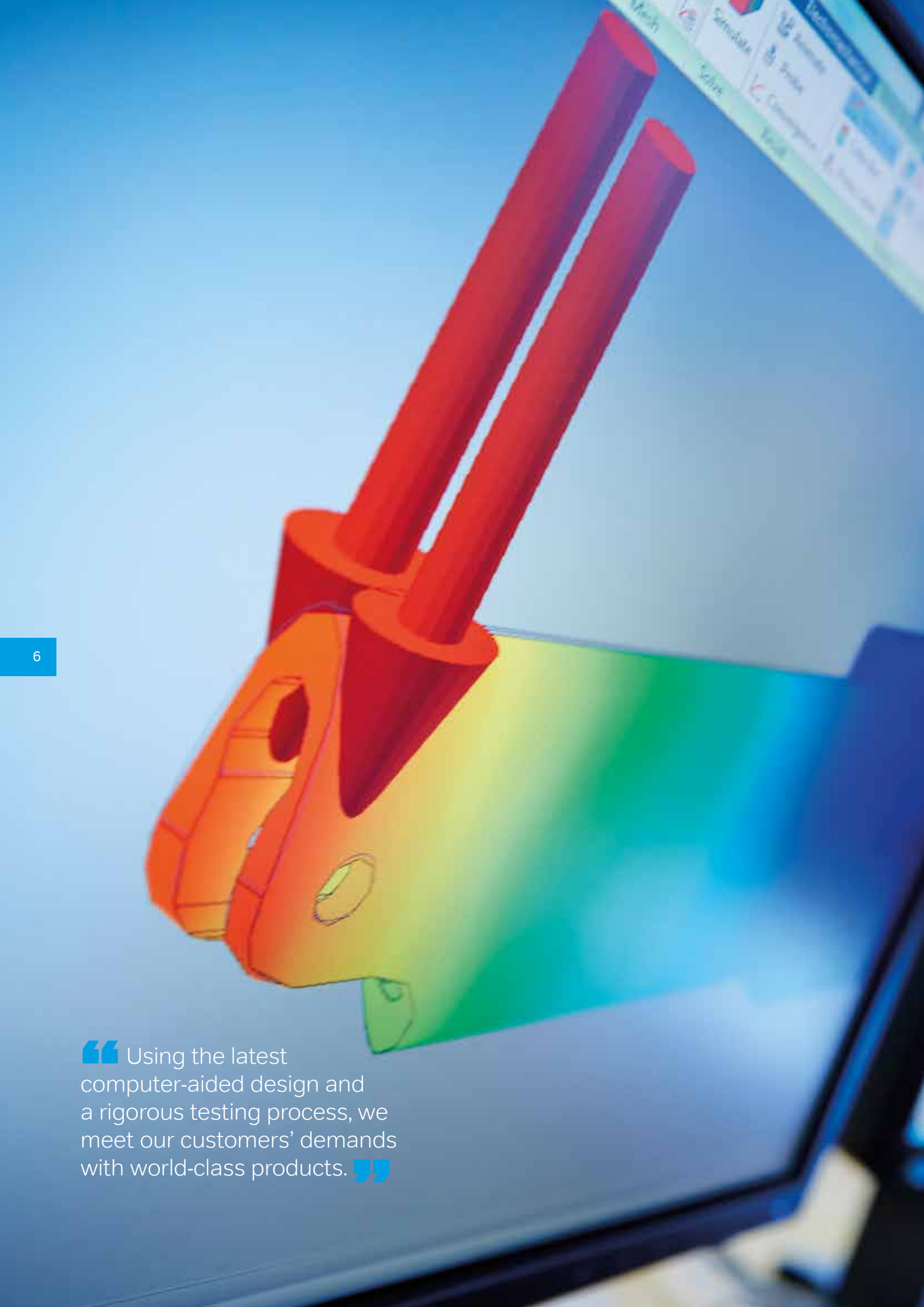

“ Using the latest computer-aided design and a rigorous testing process, we meet our customers’ demands with world-class products. ”



# Design

Our products are not only strong, but easy-to-use, stylish and light. Autochair continues to lead the industry in design and innovation.



## The beginnings of our products

New ideas come by talking to our customers about their needs. We draw up concepts that directly meet their demands before assessing their feasibility and taking the best ideas forward.



## From sketchpad to computer

Sophisticated computer software means not only can we generate virtual 3D prototypes on screen, we can test how a new product will function before it is manufactured for real.



## An Autochair product is born

Every prototype is subjected to months of rigorous testing and trials in our research & development facility and out in the field before they are declared fit and ready for manufacture in our state-of-the-art factory.



## Ready for manufacture

It's all systems go as our new products finally roll off the assembly line, with our marketing, customer service and service delivery teams ensuring that they reach our customers safely and swiftly.



# Manufacturing

We use the latest manufacturing techniques and advanced materials to make world-class products where quality and assurance come built-in as standard.







## Built to the highest standards

Our products have the power to change lives, which is why we insist on using only high quality materials and have invested heavily in our factory to ensure that reliability is built into every component. By using advanced manufacturing processes within carefully controlled production systems, our highly trained staff help us maintain our commitment to creating complex, precision products capable of performing in the face of the most challenging demands.

“ ...our highly trained staff help us maintain our commitment to creating complex, precision products capable of performing in the face of the most challenging demands. ”

M Walker  
**Managing Director**





“...we have invested heavily in our factory in order to ensure that reliability is built into every component.”

A Clewlow  
**Operations Director**

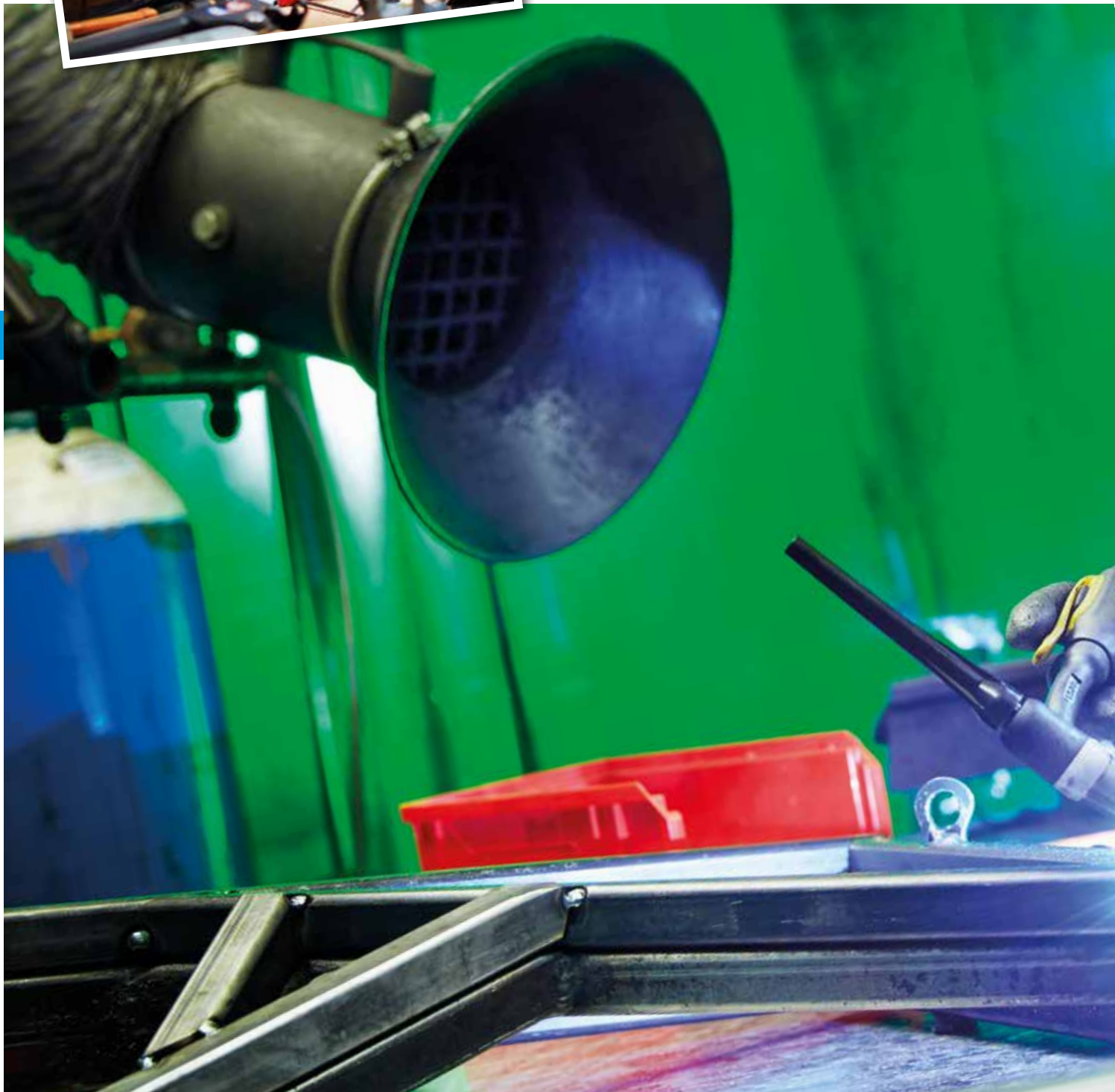



## A few words from our staff...

“ Every day at Autochair is so different, I enjoy the challenge and helping people regain their independence. ”



**Riannah**  
Sales  
Advisor

“ Being able to advise customers on what products are going to be best for them to get mobile again is so rewarding. ”



**Rachel**  
Sales  
Advisor



# Load Testing

Autochair's products are meticulously load-tested to ensure that whilst looking good they deliver the most powerful lifting performance on the market.

## Wheelchair and Scooter Hoists

### The Olympian

Maximum Weights Available



### Mini Hoist

Maximum Weights Available



## Person Lifts

### The Milford

Maximum Weights Available



### Milford SmartBase

Maximum Weights Available



See product pages for more details



“ Every one of our products is tested to the limit to ensure they deliver performance you can rely on. ”

S Pepper  
**Manufacturing Manager**





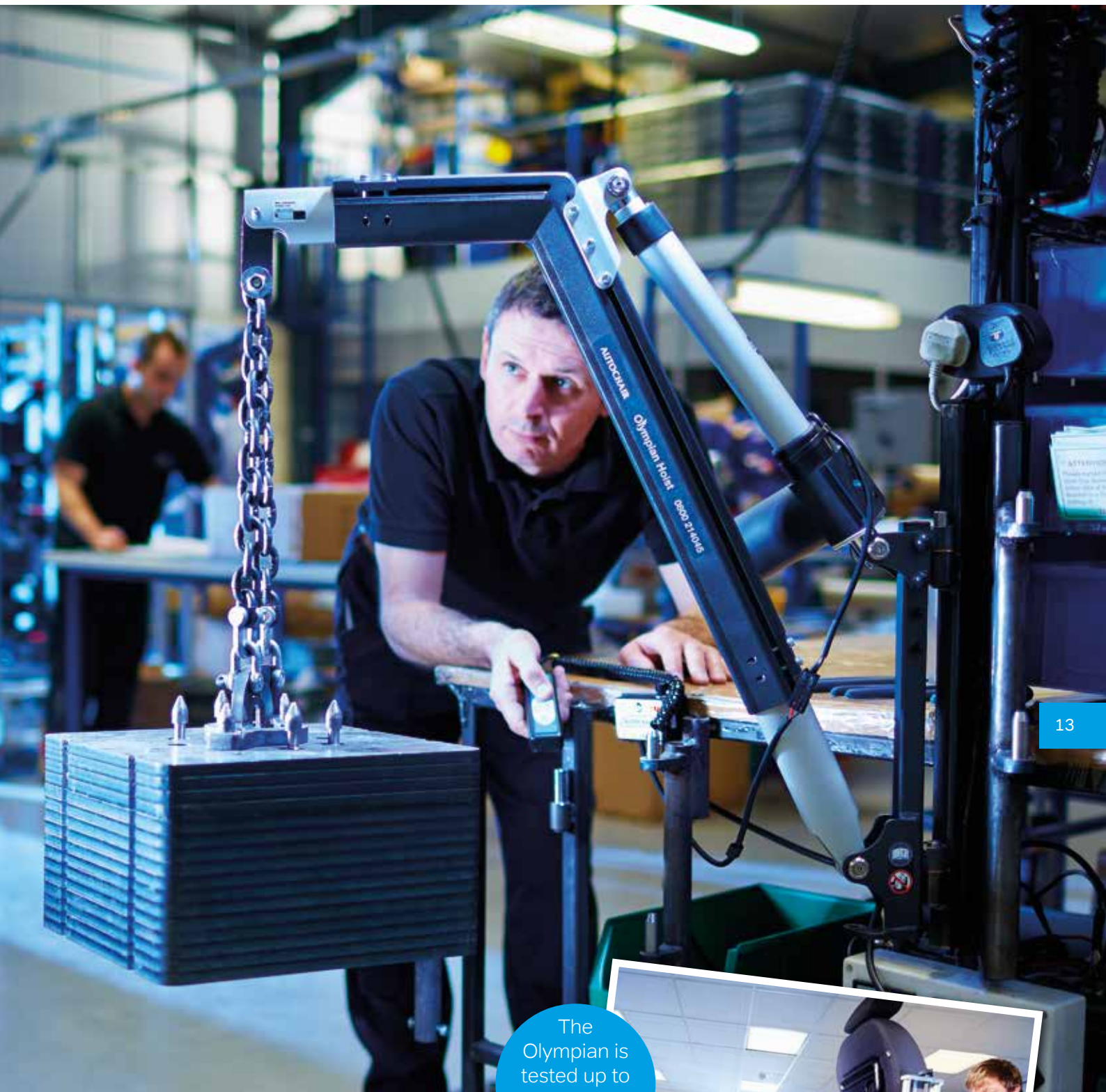

The  
Olympian  
is tested  
up to  
200kg



## Our robust testing facility

Every new Autochair product is subjected to a stringent weight load verification test performed in line with strict design and compliance control test procedures. Only then, following further dynamic and accelerated product life testing, will our R&D team be satisfied that it delivers the reliability and quality performance our customers deserve, whilst also meeting the relevant international design standards.



# Expert installations

Thanks to our precision engineering and robust testing programme our products can be easily and discreetly installed, ensuring a high quality finish every time.

“  
Our customers drive very many different makes and models of car – which is why our products are designed to fit them all.  
”





## An Autochair device can be removed and reinstalled when you change your vehicle

Our customers drive very many different makes and models of car – which is why our products are specifically designed to fit them all. This makes them easy to install and transfer from vehicle to vehicle.







“ Thank you for your quick and friendly service. We are both grateful for a bit more help to enable us to continue leading as full a life as possible. ”

Mr & Mrs Wilson  
[Appleby-in-Westmorland](#)







“  
 ...the Olympian hoist is capable of lifting all types of scooter or powerchair effortlessly into the back of your vehicle...  
 ”

# The Olympian



The Olympian is a scooter and powerchair hoist. Its powerful lifting capacity enables drivers to transport some of the biggest and largest scooters on the market. The Olympian is capable of lifting scooters and powerchairs weighing up to 200kg!

And thanks to its advanced engineering and superb design, the Olympian hoist is capable of lifting all types of scooter or powerchair effortlessly into the back of your vehicle at the touch of a button – yet can be easily detached to save valuable space in the boot.



## Why choose The Olympian?

-   Easy to use



---

-   Lifts all types of scooters and powerchairs



---

-   Manufactured in the UK



---

-   Over 300 vehicle specific installation kits

---

-   Lifts up to 200kgs

---

-   Transfer easily to your next vehicle



Lift and load in just 60 seconds!





## How The Olympian works

Stylish and strong, the Olympian is also easy to use thanks to a simple operating system that makes loading your mobility scooter into your vehicle possible at the merest touch of a button.





10  
SECONDS



Attach lifting straps to your mobility scooter

30  
SECONDS



Press the button to begin hoisting



50  
SECONDS



Gently guide your mobility scooter as it lifts



60  
SECONDS



Your mobility scooter is safely stowed

## Want to learn more?

Contact your Autochair representative for further information. Call on **+44 1773 838 276**, email **export@autochair.com** or visit the website **www.autochair.co.uk**



Find out more, call us on **+44 1773 838 276**







Folding Boot Scooters



Large Scooters



Medium Scooters



Powerchairs

# Versatility of The Olympian

Clever design and supreme lifting power means that the Olympian scooter and powerchair hoist is suitable for use in more than 300 different makes and models of car, meaning our customers can enjoy greater independence without having to change their vehicle.

Fits a variety of manufacturers vehicles







Leaves  
you with  
space to use  
your boot

21

## Will it fit?

Our factory takes delivery of the very latest makes and models of cars on a weekly basis so that our engineers can keep abreast of the latest changes in vehicle design. All you need is a vehicle with a boot large enough to accommodate your scooter or powerchair and our fitters will do the rest.

If you're not sure your vehicle is suitable call our friendly advisors who can answer any questions you may have. Contact your Autochair representative on **+44 1773 838 276**, email **export@autochair.com** or visit the website **www.autochair.co.uk**



We can help, call us on **+44 1773 838 276**







“ Very good prompt service, extremely polite and very helpful. I would recommend to other people. ”

Ms Penny  
**Llandrindod Wells**



Ideal for mini scooters...



...as well as wheelchairs





...our Mini Hoist allows you to enjoy greater mobility thanks to its user-friendly operation and clever design.



# The Mini Hoist

Designed to lift scooters and wheelchairs weighing less than 80kg, our Mini Hoist allows you to enjoy greater mobility thanks to its user-friendly operation and clever design. Straightforward to fit, suitable for a wide range of vehicles and easily detachable when not in use, the Mini Hoist makes light work of loading and unloading.

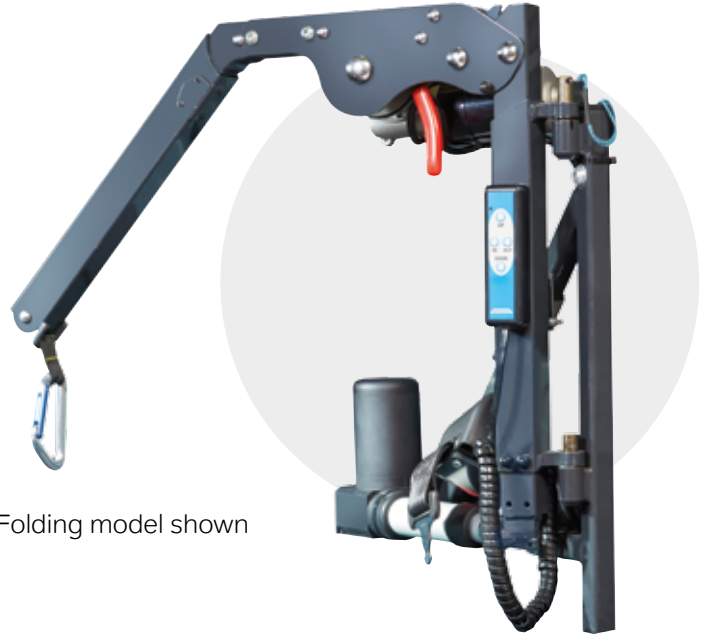

Folding model shown

## Why choose The Mini Hoist?



Easy to use



Lifts all types of mini scooters and wheelchairs



Manufactured in the UK



Over 300 vehicle specific installation kits



Lifts up to 80kgs



Transfer easily to your next vehicle

## Perfect for lifting mini scooters





Perfect  
for mini  
scooters



24

## How the Mini Hoist works

A hand-held controller is all you need to operate the Mini Hoist, which uses power drawn from your car's battery to lift your scooter or wheelchair to the correct height before it can be guided into the vehicle's boot and gently lowered into place.





1



Attach mini scooter or wheelchair using the easy to use attachment strap



2



Press the button to begin hoisting



3



Gently guide your mini scooter or wheelchair as it lifts



4



The seatbelt restraint ensures your mini scooter or wheelchair is safely stowed

## Want to learn more?

Contact your Autochair representative for further information.  
 Call on **+44 1773 838 276**, email **export@autochair.com** or visit  
 the website **www.autochair.co.uk**

 Find out more, call us on **+44 1773 838 276**







“ The guys who fitted the Milford person lift were absolutely fantastic. I could not have wished for better or friendlier guys. ”

Ms O'Malley  
**Penicuik**



Move straight from chair into vehicle



Also adaptable for rear seat passengers





“ Strong, light and easy to dismantle when not in use, the Milford can be used at home, on holiday or even in the office. ”

## The Milford

The Milford Person Lift is designed to smoothly transfer users from a wheelchair directly into a standard car seat – so there’s no need to change your vehicle. Strong, light and easy to dismantle when not in use, the Milford can be used at home, on holiday or even in the office.

The Milford can be fitted to any make or model of car in a matter of hours. However, its suitability may be limited by the height, weight, size and disability of the individual user.

### Sling options



Standard sling



Double amputee sling







Fur lined sling





Mesh sling

### Why choose The Milford?

  Works with standard car seats in any make or model

  Simple to install, assemble and operate

  No extra lifting required

  Can lift up to 23 and a half stone (150kgs)

  Can be used in and around the home



## How The Milford works

Whether you want to get behind the wheel or travel as a passenger, the Milford will transfer you from your wheelchair and into your car seat by gently lifting you up using a comfortable sling and lowering you into position.





The sling can be placed on the seat before the user is seated or whilst they are sat in the wheelchair.



Securely attach the sling to the 4 point lifting attachment.



Press the up button and then guide the person into the car.



Unclip the sling and stow the lift ready for travel.

## Want to learn more?

Contact your Autochair representative for further information.  
Call on **+44 1773 838 276**, email **export@autochair.com** or visit  
the website **www.autochair.co.uk**

 Find out more, call us on **+44 1773 838 276**





Lightweight battery pack

“ After struggling for ages to manoeuvre my husband from his chair to his wheelchair, we discovered the SmartBase...a really big help around the home ”



Completely portable - folds down flat

Folds flat  
ideal for use  
around the  
home



# The Milford SmartBase

Over the years Autochair's Milford person lift has not only enabled thousands of people to get behind the wheel of their car, it has given them greater mobility in the home too. This is all thanks to the Milford SmartBase, which is a fully portable version of our best-selling lift and is specially designed to transfer users from their wheelchairs and into seats at home, at work or even on holiday.

“  
The Milford SmartBase works with our best-selling person lift, the Milford.  
”



Easy to use steering handle





Locking wheels for safety



Soft grip handle for comfort

## Why choose The Milford SmartBase?

  Adjustable leg width to suit space available

  Simple to assemble and operate

  No extra lifting required

  Can lift up to 23 and a half stone (150kgs)

  Easily manoeuvred in and around the home



## Want to learn more?

Contact your Autochair representative for further information. Call on **+44 1773 838 267**, email **export@autochair.com** or visit the website **www.autochair.co.uk**

 Find out more, call us on **+44 1773 838 276**



# Serving Europe and beyond...

We supply vehicle adaptations throughout Europe, North America and Australia, both directly to our customers and through our extensive international dealer network.

Our headquarters in Derbyshire, England not only house our research and development, manufacturing and testing departments, but also our dealer training and fitting facilities. Our location means that wherever you are in the world, we can help you live your life independently.

*Our strength is your freedom*



Dealer Details



Call +44 1773 838 276



[www.autochair.co.uk](http://www.autochair.co.uk)