



TECHNOLOGY BROCHURE

Heating with airborne and geothermal energy:

VITOCAL





Heating with airborne and geothermal energy – making the best possible use of renewables

This brochure provides detailed information on sustainable and environmentally responsible heat generation using heat pumps from Viessmann.

Heat pumps utilise renewable energy from the ground, sun, groundwater or air. They lower consumption of fossil fuels, conserve valuable resources and reduce CO₂ emissions that damage the environment.

Viessmann heat pumps offer their users an additional benefit – many of them feature active and natural cooling functions. Alongside their classic application as heat generators on cold days, they can also create a pleasant interior in summer by bringing refreshing cool air into the house.

Viessmann's extensive product range offers the right heat pump to suit every demand. Even at the design stage, structural and geological conditions, as well as personal and individual preferences concerning the heat demand can be taken into account. Running a heat pump with power generated on site by a photovoltaic system is particularly environmentally responsible and very affordable.

Viessmann heat pumps can be used in new build and modernisation projects, operated together with solar thermal systems and even combined with an existing oil or gas heating system to form a multi mode system. This allows every building and property owner to put their plans into action in the most efficient way possible.



Heat pumps from Viessmann offer tailor-made solutions for central heating and cooling, as well as convenient hot water supply, for both new build and modernisation projects.



6



12

6 SAVING ENERGY AND PROTECTING THE CLIMATE

By modernising your heating system, you are making an active contribution towards protecting the climate and saving fossil fuels.

12 BRINE/WATER HEAT PUMPS

Brine/water heat pumps use the ground as their primary energy source, either with geothermal collectors or geothermal bore holes.



30



48

30 AIR SOURCE HEAT PUMPS

Air source heat pumps utilise outdoor air or extract air as a primary energy source.

48 SYSTEM TECHNOLOGIES DESIGNED TO WORK TOGETHER

System technology from Viessmann perfects your new heating system: Vitotronic control units and Vitocell DHW cylinders as well as high grade solar technology for cost effective domestic hot water heating and central heating backup.



50

50 THE COMPANY

The power of innovation: a family business for three generations, Viessmann offers state of the art technology and takes its responsibilities seriously.

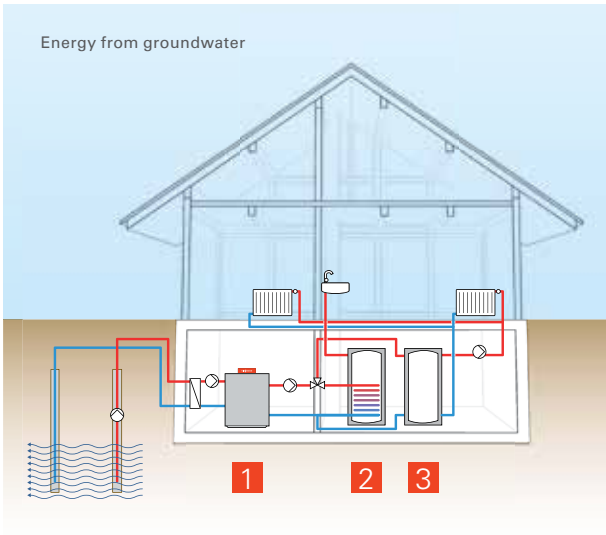
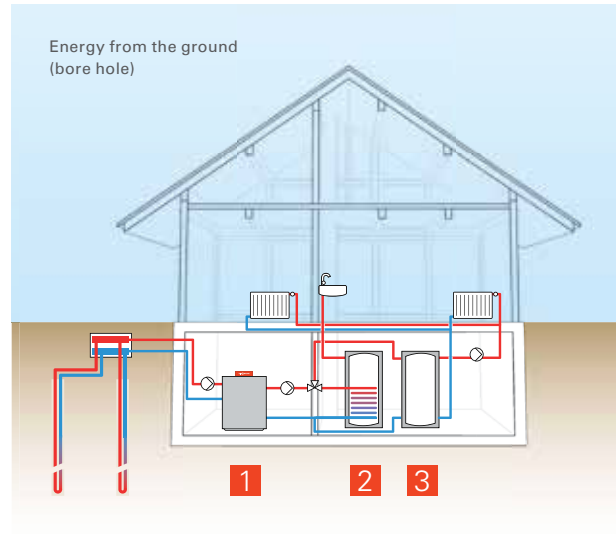
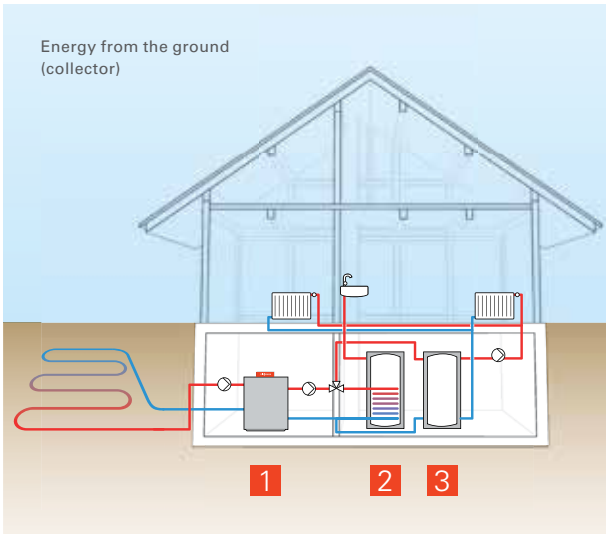

- 1 Vitocal heat pump
- 2 DHW cylinder
- 3 Heating water buffer cylinder
- 4 Outdoor unit

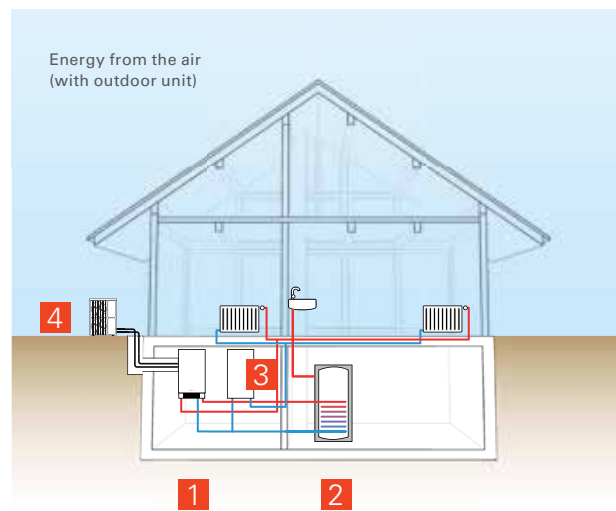
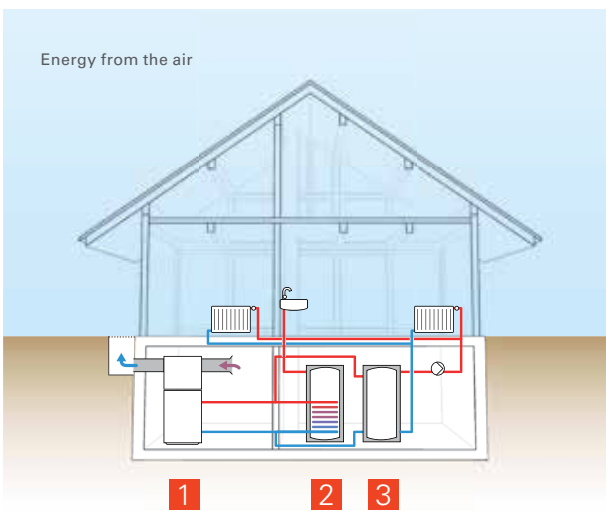

Viessmann heat pumps are recommended for new build and modernisation

The air, ground, water and waste heat are primary energy sources that are practically free and can be used to run a heat pump system efficiently.

Heat pumps work like a refrigerator, just in reverse. While a refrigerator directs heat to the outside, heat pumps take energy from the air or the ground and transfer it into the living space via the heating system. The transfer medium carrying the heat drawn from the environment is compressed in order to reach the flow temperatures necessary for different heating systems.

For example, a heating system with radiators requires temperatures of up to 70°C. Underfloor heating systems, however, manage with a flow temperature of 30°C. This makes heat pumps suitable for both modernisation and new build.

State of the art compressor technology for the highest level of efficiency

The compression process is critical for the efficiency of a heat pump. Viessmann uses the most advanced components in its heat pumps. Their operation is characterised by quiet running, low vibrations and an extremely long service life without the need for maintenance.

To generate heat, thermal energy is extracted from the environment and used to evaporate a refrigerant that boils at a low temperature. The compressor compresses the gas this creates and raises it to a higher temperature level.

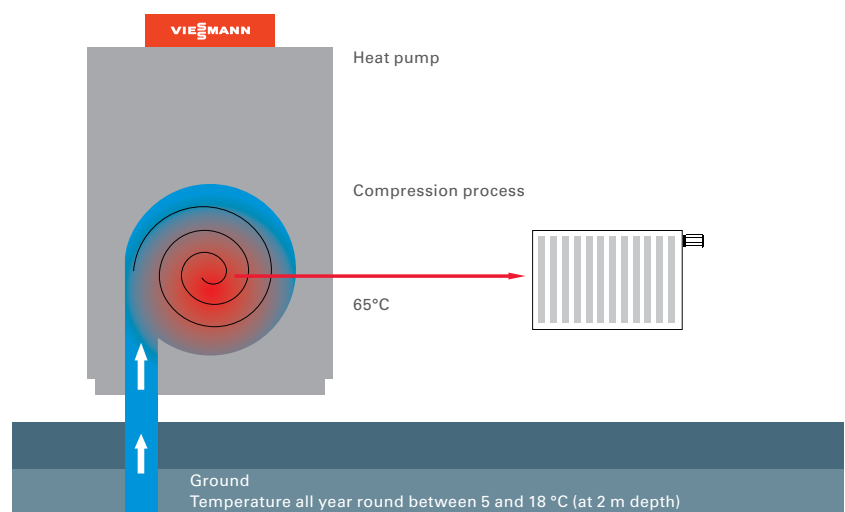

Getting hotter towards the centre: at an initial temperature of between 5 and 18°C, a flow temperature of up to 72°C is reached.

A heat exchanger transfers the energy from the heated gas to the heating circuit. The refrigerant, which is still under pressure, condenses again and is expanded in an expansion valve. The cycle then begins again.

Use with various energy sources

The best energy source for each individual case depends on local conditions and the actual heat demand. Viessmann heat pumps can use various energy sources:

- Air – unlimited availability; lowest investment outlay
- Ground – via geothermal collector, geothermal bore hole or ice store; very efficient
- Water – extremely efficient; observe water quality
- Waste heat – subject to availability, amount and temperature level

Annual coefficient of performance

When designing a system, it is necessary to consider its likely use over an entire year. To do this, the amount of heat delivered is compared with the total electricity demand of the heat pump system. This includes the power drawn by pumps and control units, etc. The result is referred to as the annual coefficient of performance (COP).

The annual COP is the ratio of heat transfer to power consumption. The higher this coefficient, the more efficiently the heat pump is working.

The quick and easy way to save energy

Enjoy energy savings, convenience and reassurance.



The ViCare app offers you a convenient way to operate your heating system and save energy – anytime, anywhere. It allows you to keep an eye on the system status at all times. You can set the required room temperature with a single swipe; one tap of the screen allows you to select a daily template and save energy automatically.

The ViCare app offers new possibilities for controlling heating systems via the internet. The design of the ViCare graphic interface has been kept simple, enabling completely intuitive heating system operation.

Save energy automatically

The system is designed to control one heating circuit. You can set the required room temperature via the touchscreen, and switch between standard and party mode ("I'm home longer") with a single tap.

When leaving the house ("I'm away"), it takes just one command to reduce the heating system to a lower temperature and therefore save energy. Anyone wanting to program different switching times for each day will appreciate the assistant function.

A separate button on the start screen shows the current outside temperature and, with just one tap, the temperature history over the last few days.

System status at a glance

The user can see at a glance whether their heating system is working as it should. Yellow lets you know about a pending service and red automatically offers to contact the contractor.

This requires consent from the system user, which can be granted within the app with just two taps. The connection to the trade partner's software is then established and they can view the system data, in order to provide their customer with quick and efficient support.

Vitoconnect internet interface

Vitoconnect is the interface between the boiler and ViCare. It is not only compatible with new Viessmann heating systems, but is also available for many existing appliances. It is connected directly via a cable. A plug-in power supply unit is included in the standard delivery. A small accessory, measuring only 10 x 10cm, is available for wall mounting.

Connect the module to the internet and register via plug & play. Simply scan the supplied QR code using a smartphone. Installation and commissioning is then usually completed in just a few minutes.

ViCare accesses the Vitoconnect online interface to control the heat generator. Once the system user has given their consent, the contractor can use Vitoguide to keep a constant eye on their customer's system.



Vitoconnect with sockets for the plug-in power supply unit (left) and data connection.

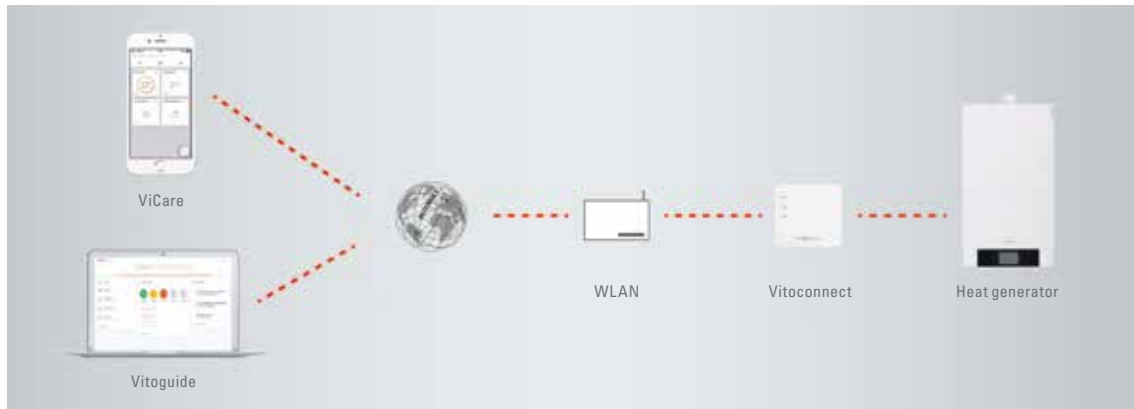

REASSURANCE

Warmth and reassurance

- + Green for go – see at a glance whether everything is OK
- + Be informed about a pending service
- + Direct access to the address of the saved contractor



ECONOMY

Simply set your preferred temperature – save costs when you're not at home

- + Straightforward, convenient operation of the heating system
- + Record your daily routine and automatically save on energy costs
- + Set standard functions at the tap of a button on your smartphone



SUPPORT

A direct link to the contractor – just in case

- + Simply enter the contact details of the contractor
- + Quick and effective assistance – the contractor has all of the important information
- + All-inclusive carefree safety and maintenance package

Explore the app in advance – no need to register!

Simply download the app and tap 'Discover ViCare' on the app's start screen – and off you go, with no need for an actual heat generator or internet connection.





ViCare app



BRINE/WATER HEAT PUMPS



5.7 to 85.6 kW

		Heat source		Application				Integral DHW cylinder	Cooling function NC/AC	Page
		Ground	Water	Detached house	Apartment building	Commercial premises	High temperature			
	VITOCAL 222-G 5.8 to 10.4 kW	■		■				■	■ ¹⁾ / –	12
	VITOCAL 300-G 5.7 to 17.2 kW (single stage) 11.4 to 34.4 kW (two-stage)	■	■	■	■				■ ¹⁾ / ■ ¹⁾	18
	VITOCAL 200-G 5.6 to 9.7 kW	■		■	■				■ ¹⁾ / –	20
	VITOCAL 350-G 20.5 to 42.3 kW (single stage) 41.0 to 84.6 kW (two-stage)	■	■		■	■	■		■ ¹⁾ / ■ ¹⁾	24
	VITOCAL 300-G 21.2 to 42.8 kW (single stage) 42.4 to 85.6 kW (two-stage)	■	■		■	■			■ ¹⁾ / ■ ¹⁾	26

¹⁾ Accessories required

BRINE/WATER HEAT PUMPS
5.7 TO 85.6 KW
AIR SOURCE HEAT PUMPS
2.3 TO 18.5 KW

AIR SOURCE HEAT PUMPS
2.3 to 18.5 kW

	Model	Application							Integral DHW cylinder	Cooling function AC	Page
		Monobloc indoor installation	Monobloc outdoor installation	Split	Detached house	Apartment building/ commercial premises	New build	Modernisation			
	VITOCAL 350-A 10.6 to 18.5 kW	■	■		■				■		32
	VITOCAL 300-A 5.8 to 13.4 kW		■		■		■			■	34
	VITOCAL 200-A 2.3 to 11.8 kW		■		■		■			■	36
	VITOCAL 222-A 2.3 to 11.8 kW		■		■		■	■		■	38



VITOCAL 222-G

Compact, floorstanding heat pumps that take up little space and are particularly quiet in operation – making them suitable even for installation near the living space.

The Vitocal 222-G compact brine/water heat pump is fully equipped with all of the components required for DHW and central heating.

With heating outputs of between 5.8 and 10.4 kW, they are ideal for use in detached houses. Flow temperatures up to 65°C also enable use with conventional radiators.

The heat pump is an attractively priced alternative to the compact appliance in the 300 series. With its refrigerant circuits with a fixed heating output, in three output sizes, and an electronically controlled expansion valve, it achieves a COP (coefficient of performance) of up to 4.8 (to EN 14511 (5/2018) at B0/W35).

Small footprint

The small footprint of this heat pump makes it particularly suitable where space is at a premium – the brine circulation pump, heating circuit pump and 3-way diverter valve are already integrated inside the compact casing.

If required, to simplify the handling and installation of the Vitocal 222-G, hydraulic and electrical plug-in connectors are available, which enable the new refrigerant circuit module to be easily removed from the heat pump and transported separately. Thanks to the flexible connection concept, the heat pump can also be quickly matched to the installation situation on site.

Particularly quiet, therefore also suitable for installation near the living space

The casing completely protects the refrigeration module/hydraulic compartment from the outside environment and, in conjunction with the three-dimensional anti-vibration mounts, minimises operating noise. These compact heat pumps are some of the quietest in their category, as they generate a sound power level of only 46 dB(A) (B0/W55).

Vitotronic 200 control unit with optional app control

The Vitotronic 200 control unit, with plain text and graphic display, is simple and intuitive to use. Settings can quickly be changed by following the user prompts. Control via the internet through the ViCare app on a mobile device is also an option.

TAKE ADVANTAGE OF THESE BENEFITS

- + Compact brine/water heat pumps with heating outputs from 5.8 to 10.4 kW
- + High DHW convenience with 220 litres DHW cylinder
- + Low running costs thanks to optimised DHW efficiency – DHW energy efficiency class: A+
- + Low running costs thanks to optimised SCOP (seasonal coefficient of performance) to EN 14825: up to 5.4 (cold climate/low temperature applications)
- + COP (coefficient of performance) to EN 14511 (5/2018): up to 4.8 (B0/W35)
- + Barely audible, even when installed near the living space, thanks to an innovative sound attenuation concept resulting in a sound power level of max. 46 dB(A) (B0/W55)
- + Compact dimensions and small footprint to maximise available space in the building
- + High operating convenience – heating, cooling, DHW and ventilation via the integral Vitotronic control unit
- + Increased utilisation of power generated on site by photovoltaic systems due to low output modulation of the heat pump
- + Web-enabled through Vitoconnect (accessory) with ViCare app
- + Control of a Vitovent 300-F mechanical ventilation unit

The Vitocal 222-G compact heat pumps include a brine/water heat pump, DHW cylinder, high efficiency circulation pump, 3-way diverter valve and instantaneous heating water heater.

Steel DHW cylinders with Ceraprotect enamel coating and a cylinder capacity of 220 litres ensure a high level of DHW convenience.

Online control via the ViCare app

Using the optional Vitoconnect internet interface, the heat pump can be controlled online from anywhere via the free ViCare app on any standard mobile device. At the appliance itself, the Vitotronic 200 control unit with plain text and graphic display enables intuitive and menu-guided operation.

Vitocal 222-G with large DHW cylinder

The Vitocal 222-G compact heat pump offers a high level of DHW convenience thanks to its 220 litre DHW cylinder, which is heated via an internal indirect coil.

Particularly quiet operation

The sound-optimised appliance design makes these compact heat pumps particularly quiet so that they can even be installed close to the living space.

Natural heating – natural cooling

The compact heat pumps can provide a pleasant indoor climate in a low energy house, even on hot summer days. The natural cooling function brings cool underground temperatures into the home. For this, the Viessmann NC-Box is required as an accessory.

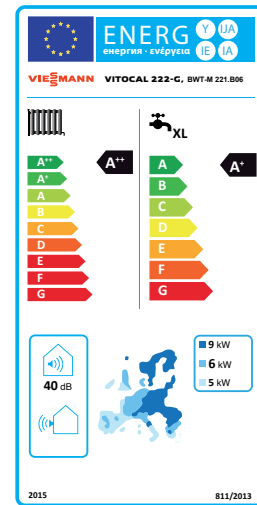

Energy efficiency label
Vitocal 222-G



Vitocal 222-G appliances are
KEYMARK certified.

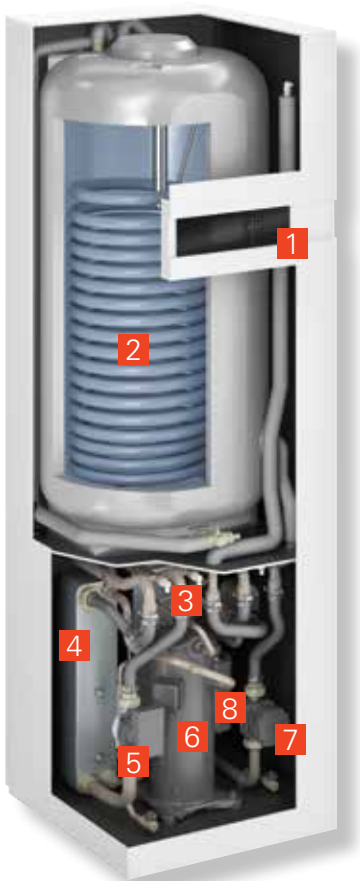

VITOCAL 222-G

- 1 Vitotronic 200 control unit (type WO1C)
- 2 Steel DHW cylinder with Ceraprotect enamel coating, 220 litre capacity
- 3 Hydraulic plug-in connectors
- 4 Evaporator
- 5 Primary pump (high efficiency circulation pump)
- 6 Scroll compressor with fixed heating output
- 7 Secondary pump (high efficiency circulation pump)
- 8 Instantaneous heating water heater

VITOCAL 222-G
5.8 to 10.4 kW



Vitocal 222-G
Compact brine/water heat pump with integral DHW cylinder



Easy to operate Vitotronic control unit with straightforward navigation and clear menu tree.

TAKE ADVANTAGE OF THESE BENEFITS

- + Compact appliance with a heating output from 5.8 to 10.4 kW
- + Cylinder capacity: 220 litre
- + Flow temperature: up to 65°C
- + COP (coefficient of performance) to EN 14511 (5/2018):
up to 4.8 (B0/W35)
- + SCOP (seasonal coefficient of performance) to EN 14825:
up to 5.4 (cold climate/low temperature application)
- + Sound power level: maximum of 46 dB(A) (B0/W55)
- + Energy efficiency class: A++
- + DHW energy efficiency class: A+

For specification, see page 40



VITOCAL 300-G / VITOCAL 200-G

Flexible configuration of Viessmann heat pumps: either brine/water heat pump, or water/water heat pump with conversion kit, depending on the primary energy source.

The floorstanding Vitocal 300-G and Vitocal 200-G brine/water heat pumps recover heat from high yielding heat sources. For this purpose, a geothermal bore hole or geothermal collector installed on the property. In all these cases, these appliances cover the entire energy demand, even on colder days.

As an alternative, depending on the location of the house, it may also be possible to utilise the thermal energy contained in the groundwater. In addition, the Vitocal 300-G can also be configured for straightforward operation as a water/water heat pump. They are equally well suited to new build and modernisation, in both detached houses and apartment buildings.

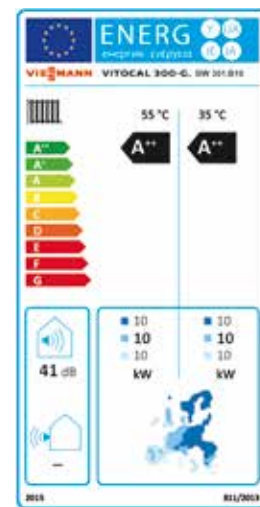

Energy efficiency label
Vitocal 300-G, BW 301.B10



EHPA Quality Label as proof of the COP, for subsidy according to the German market incentive programme

TAKE ADVANTAGE OF THESE BENEFITS

- + Monovalent operation for DHW and central heating is possible all year round
- + Vitocal 300-G: low operating costs with the highest level of efficiency at every operating point due to the innovative refrigerant cycle diagnostic (RCD) system with electronic expansion valve (EEV)
- + Prepared for the use of power generated on site, for example by photovoltaic systems
- + Web-enabled via free ViCare app and Vitoconnect (optional)
- + Control of Viessmann ventilation units possible
- + Easier handling through small and light modules

For specification, see page 41



Vitocal 300-G heat pump with Vitocharge power storage system and Vitocell 100-V DHW cylinder

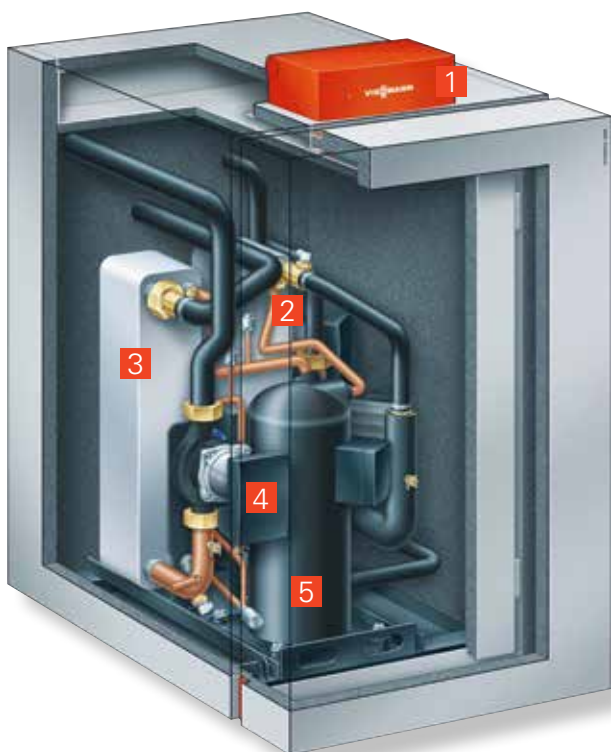

VITOCAL 300-G

- 1 Vitotronic 200 heat pump control unit
- 2 Condenser
- 3 Large area evaporator for an efficient exchange of heat
- 4 High efficiency pump
- 5 Hermetically sealed Compliant scroll compressor

VITOCAL 300-G

5.7 to 17.2 kW (SINGLE STAGE)

11.4 to 34.4 kW (TWO-STAGE)

With five output stages, the Vitocal 300-G brine/water heat pump can be used to cover the heat demand required for a number of different heating systems.

Modular solution for higher heat demand

Where there is a higher heat demand, the two-stage Vitocal 300-G, based on the master/slave principle, is the right choice. It can also be configured for ground or groundwater as the heat source. Two heat pumps can be linked together if a higher heating output is required. The modular design, with separate compressor circuits, also ensures particularly high levels of efficiency in partial load operation, and enables simultaneous DHW and central heating. The master module regulates the slave module.

Reliable and quiet

The powerful Compliant scroll compressor fitted in the Vitocal 300-G heat pump is outstanding on account of its high operational safety, reliability and especially quiet operation. To achieve this, the appliance is equipped with dual anti-vibration mounts to prevent structure-borne noise transmission and insulate the casing against airborne noise. At the same time, the compressor guarantees the highest coefficient of performance (COP up to 5.0) and flow temperatures up to 65°C.

The refrigerant cycle diagnostic (RCD) system constantly monitors the refrigerant circuit in the Vitocal 300-G and, in conjunction with the electronic expansion valve, ensures the highest efficiency at every operating point, which results in high annual coefficients of performance.

Vitotronic 200 with energy statement facility

The Vitotronic 200 is straightforward and intuitive to operate, thanks to the plain text user prompts and graphic display. Amongst other features, it enables a differentiated energy statement, which is accepted by subsidy bodies [in Germany].



Vitocal 300-G two-stage heat pump (master/slave)

TAKE ADVANTAGE OF THESE BENEFITS

- + Floorstanding brine/water heat pumps:
Single stage heating output: 5.7 to 17.2 kW, two-stage heating output: 11.4 to 34.4 kW
- + Heating output in water/water configuration: 7.5 to 42.2 kW
- + Flow temperature: up to 65°C
- + Control via mobile devices and the Vitotrol app

For specification, see page 41

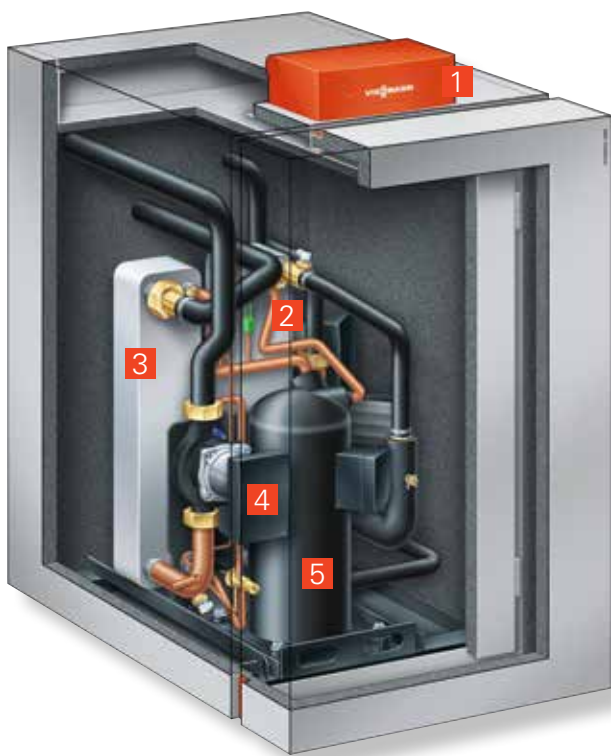
**VITOCAL 200-G**

- 1** Vitotronic 200 control unit
- 2** Condenser
- 3** Large area evaporator for an efficient exchange of heat
- 4** High efficiency pump
- 5** Hermetically sealed Compliant scroll compressor

With its good price/performance ratio, the Vitocal 200-G compact brine/water heat pump is ideally suited to new build detached and two-family houses. Its innovative technology, with efficient Compliant scroll compressor, enables it to achieve a maximum flow temperature of 60°C.

**Two heating circuits
for tailored heating
convenience**

The heat pump meets all the requirements for a newly built detached or semi-detached house. The Vitotronic 200 weather-compensated control unit allows two separate heating circuits to be integrated.

Straightforward installation

The Vitocal 200-G is delivered as standard complete with integral high efficiency pumps for the brine and heating circuits, a circulation pump for cylinder heating, and a safety assembly.

**Vitotronic 200 control unit
with optional app control**

The Vitotronic 200 control unit, with plain text and graphic display, is simple and intuitive to use. Settings can quickly be changed via the menu. Control via the internet through the Vitotrol app on a mobile device is also an option.



Vitotronic 200 control unit

Cooling and ventilation

The natural cooling function is already included. To use this, the Vitocal 200-G must be equipped with an NC-Box (accessory). The Vitotronic 200 can also be used to control the Vitotent 300-F ventilation unit.

**Prepared for photovoltaic
power**

The Vitocal 200-G heat pump is already prepared for the utilisation of more affordable power generated on site by a photovoltaic system. An intelligent controller increases on-site consumption of power generated by the PV system.

TAKE ADVANTAGE OF THESE BENEFITS

- + Floorstanding brine/water heat pump
- + Single stage heating output: 5.6 to 9.7 kW
- + Flow temperature: up to 60°C
- + Control via mobile devices and the Vitotrol app

For specification, see page 41



VITOCAL 350-G / VITOCAL 300-G

Powerful heat pumps with high flow temperatures meet the requirements for high DHW convenience in large detached houses and apartment buildings.

With its two high temperature heat pumps, the Vitocal 350-G and Vitocal 300-G, Viessmann also meets the demand for higher heating outputs. Four sizes are available up to 84.6 kW.

EVI for high flow temperatures

The Vitocal 350-G achieves high flow temperatures of up to 70°C. This results from the use of an EVI (enhanced vapour injection) refrigerant circuit, where an intermediate vapour injection cools the refrigerant so that it can be more densely compressed than is otherwise possible. The Vitocal 350-G also delivers sufficiently high temperatures to make it suitable for modernising apartment buildings with radiator heating systems.

RCD system for highest level of efficiency

RCD stands for refrigerant cycle diagnostic system. This provides constant monitoring of the refrigerant circuit in Vitocal high temperature heat pumps and, in conjunction with the electronic expansion valve, ensures the highest level of efficiency at every operating point.

Perfect for high heating output

The Vitocal 350-G/300-G is an economical solution for higher heat demands. It allows the heating flow and return lines of several heat pumps to be linked in a cascade.

A heat pump cascade consists of one lead heat pump and up to four lag heat pumps. Both the lead heat pump and the lag heat pumps can have two stages. This not only delivers the higher heating output required, but also increases the operational reliability of the entire system.

The modular design, with separate compressor circuits, also ensures particularly high levels of efficiency in partial load operation, and enables simultaneous DHW and central heating.

TAKE ADVANTAGE OF THESE BENEFITS

- + Low noise and vibration emissions through sound-optimised appliance design
- + Low operating costs with the highest level of efficiency at every operating point through the innovative RCD (refrigerant cycle diagnostic) system with electronic expansion valve (EEV)
- + Monovalent operation for DHW and central heating is possible
- + Master/slave solutions for higher heat demands and DHW convenience, e.g. combination of Vitocal 300-G and Vitocal 350-G
- + Extremely quiet operation through sound-optimised appliance design
- + Vitotronic 200 control unit with plain text and graphic display for weather-compensated heating mode and natural or active cooling
- + Control of Viessmann ventilation units possible
- + Prepared for the use of power generated on site, for example by photovoltaic systems
- + Web-enabled via free ViCare app and Vitoconnect (optional)

**VITOCAL 350-G MASTER**

- 1 Vitotronic 200 control unit
- 2 Condenser
- 3 Large area evaporator for an efficient exchange of heat
- 4 Hermetically sealed Compliant scroll compressor with EVI (enhanced vapour injection) process

VITOCAL 350-G

20.5 to 42.3 kW (SINGLE STAGE)

41.0 to 84.6 kW (TWO-STAGE)

The powerful Vitocal 350-G brine/water heat pump is one of the quietest heat generators of its kind, thanks to its low-vibration design.

Where heat demand is even higher, the Vitocal 350-G can be operated in two-stage mode with an additional heat pump of the same type, or with a Vitocal 300-G in a master/slave system, and can then provide an output of up to 84.6 kW. As early as at the design stage, this system configuration allows for optimum matching of the heat pumps to the heat demand.

Master/slave system for DHW and central heating

In a master/slave system, the Vitocal 350-G (master) delivers high flow temperatures for DHW heating, while the Vitocal 300-G (slave, without its own control unit) covers the required heat load.

The EVI refrigerant circuit enables the Vitocal 350-G to achieve an extremely high COP of up to 5.0, which contributes to its low operating costs.

Vitotronic 200 control unit with communication capability

Viessmann uses the convenient Vitotronic 200 control unit to ensure standardised operation for all its heat generators. The many functions of this control unit include operation with user prompts, an integral diagnostic system, control of the instantaneous heating water heater and an additional oil or gas boiler, and of course, natural and active cooling functions.

Furthermore, the Vitotronic 200 is capable of communicating, and via the Vitocom 300 module, allows the heat pump system to be set up, monitored and optimised over the internet with the Vitotrol app on a smartphone or tablet.

Operation with solar power generated on site

The Vitocal 350-G heat pump is already prepared for the utilisation of more affordable power generated on site by a PV system. An intelligent control unit ensures maximum consumption of self-generated power while lowering energy costs.

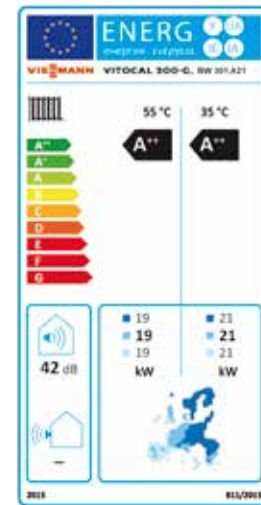

Energy efficiency label
Vitocal 300-G, BW 301.A21



EHPA Quality Label as proof of the COP,
for subsidy according to the German
market incentive programme



Two-stage Vitocal 350-G (master on the right/slave on the left) as a brine/water or water/water heat pump

TAKE ADVANTAGE OF THESE BENEFITS

- + Brine/water heat pump
- + Single stage heating output: 20.5 to 42.3 kW, two-stage: 41.0 to 84.6 kW
- + Water/water heat pump
Single stage heating output: 25.4 to 52.3 kW, two-stage: 50.8 to 117.8 kW
- + Low operating costs thanks to high coefficient of performance (COP) to EN 14511 of up to 5.0 (B0/W35)
- + Flow temperature: up to 70°C

For specification, see page 42

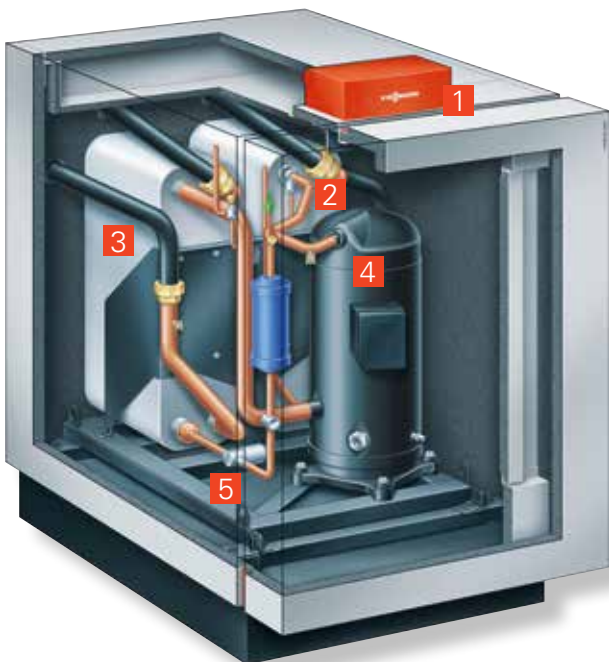
**VITOCAL 300-G**

- 1** Vitotronic 200 heat pump control unit
- 2** Condenser
- 3** Large area evaporator for an efficient exchange of heat
- 4** High efficiency pump
- 5** Hermetically sealed Compliant scroll compressor

VITOCAL 300-G

21.2 to 42.8 kW (SINGLE STAGE)

42.4 to 85.6 kW (TWO-STAGE)

The Vitocal 300-G is the specialist for large detached houses and apartment buildings. For applications with higher heat demands, the two-stage Vitocal 300-G, based on the master/slave principle, is the right choice.

Cascades up to 589 kW

It can deliver a heating output from 42.4 to 85.6 kW (brine/water) with ground as the primary heat source, or 56.2 to 117.8 kW (water/water) when using groundwater. If this is not enough, the integral cascade function enables output to be raised to up to 589 kW (water/water) with several Vitocal 300-G units.

This also assures greater operational reliability for the system as a whole. The modular design, with separate compressor circuits, also ensures particularly high levels of efficiency in partial load operation, and enables simultaneous central and DHW heating.

Powerful and reliable

At the heart of the Vitocal 300-G lies its powerful Compliant scroll compressor. This component stands out on account of its high degree of operational safety and reliability. In conjunction with the large heat exchangers and integral refrigerant manifold, the Vitocal 300-G achieves a high coefficient of performance and flow temperatures up to 60°C.

Quiet operation and great performance are not mutually exclusive

The hermetically sealed casing and particularly clever appliance design enable a reduction in noise emissions in the Vitocal 300-G that far exceeds expectations in this output range.



Two-stage Vitocal 300-G (master on the right/slave on the left) as a brine/water heat pump, two-stage: 42.4 to 85.6 kW, maximum 428 kW (as a cascade)

TAKE ADVANTAGE OF THESE BENEFITS

- + Brine/water heat pump
- + Single stage heating output: 21.2 to 42.8 kW, two-stage: 42.4 to 85.6 kW, maximum: 428 kW (as a cascade)
- + Water/water heat pump
- + Single stage heating output: 28.1 to 58.9 kW, two-stage: 56.2 to 117.8 kW, maximum: 589 kW (as a cascade)
- + Flow temperature: up to 60°C
- + Sound power level: ≤ 44 dB(A)
- + Integral energy statement
- + Easier handling through small and light modules

For specification, see page 42

**NC-Box**

Optional equipment for Viessmann heat pumps to provide natural cooling

**AC-Box**

Optional equipment for Viessmann heat pumps to provide active cooling

Natural and active cooling with heat pumps

Besides generating high levels of heating comfort and reliable DHW heating, heat pumps can also provide cooling for rooms in hot weather.

In addition to its primary function as a heating appliance, heat pumps can also provide cooling using two different methods:

- With **natural cooling**, the brine medium or the groundwater absorbs the energy from the heating circuit via a heat exchanger and transfers it outdoors. The natural ambient temperature is also used for cooling. Apart from the control unit and circulation pump, the heat pump remains switched off. This makes natural cooling a particularly energy efficient and affordable way to cool the interior of a building.
- With **active cooling**, the function of the heat pump is simply reversed. For this, the refrigerant cycle is reversed internally; alternatively the primary and secondary connections are changed over. As with a fridge, the heat pump then actively generates a cooling capacity.

Natural cooling with NC-Box – energy efficient and affordable

All the components are prefitted in the Viessmann NC-Box. This makes the thermally insulated box not only compact, but also particularly simple and quick to install.

The NC-Box is equipped with a mixer for integration in the cooling circuit. This enables continuous operation without temperatures falling below the dew point.

Active cooling with AC-Box – efficient heating and cooling

The AC-Box combines active and natural cooling in heat pump systems, thus making them even more versatile and convenient. The system changes over automatically according to the required room temperature. If only a low cooling capacity is required, natural cooling is sufficient. However, when that is no longer enough, active cooling is added.

Keeping cool when it's hot outside

The compressor circuit 'kicks in' for active cooling. Using the AC-Box, the internal control unit reverses the output and input functions and now actively transfers heat from the building to the geothermal bore hole. Cold water then flows through the heating circuit itself – cooled down to 7°C if necessary.

Utilising the energy removed

Incidentally, direct use can also be made of the heat removed from the interior in this way, for example for DHW heating or to heat a swimming pool. This means cooling and heating functions can be combined extremely effectively.



VITOCAL 350-A **VITOCAL 300-A / 200-A / 222-A**

Air source heat pumps utilise free energy from the ambient air for heating. This makes them suitable for both new build and modernisation.

The Vitocal 350-A air source heat pump is particularly suitable for modernisation; the Vitocal 300-A for modernisation and new build; and the Vitocal 200-A/222-A for new build.

Compared to a brine/water system, an investment in an air source heat pump is lower, as the costs for installing a geothermal collector or drilling holes for geothermal bore holes are not incurred.

Space saving outdoor installation

Depending on the version chosen, the heat pumps can be installed indoors or outdoors. Outdoor installation is a particularly space efficient solution. Only the control unit and hydraulic components are mounted on the wall inside the house.

Viessmann offers everything from a single source

When it comes to transporting heat into your home, you can rely on Viessmann's system competence. All pipework required for connecting the heat pump, as well as the entire range of accessories, are provided from a single source, and are perfectly matched to one another.



The Vitocal 350-A, Vitocal 300-A and Vitocal 200-A/222-A are certified in accordance with the EHPA Quality Label for heat pumps.

TAKE ADVANTAGE OF THESE BENEFITS

- + Low operating noise through generously sized air ducts, sound-optimised appliance design and night mode with reduced fan speed
- + Easy to operate Vitotronic control unit with plain text and graphic display
- + Control of Viessmann ventilation units possible
- + Installation indoors or outdoors with matching accessories
- + Efficient defrosting through circuit reversal
- + Prepared for the use of power generated on site, for example by photovoltaic systems
- + Web-enabled via free ViCare app and Vitoconnect (optional)

For specification, see page 44

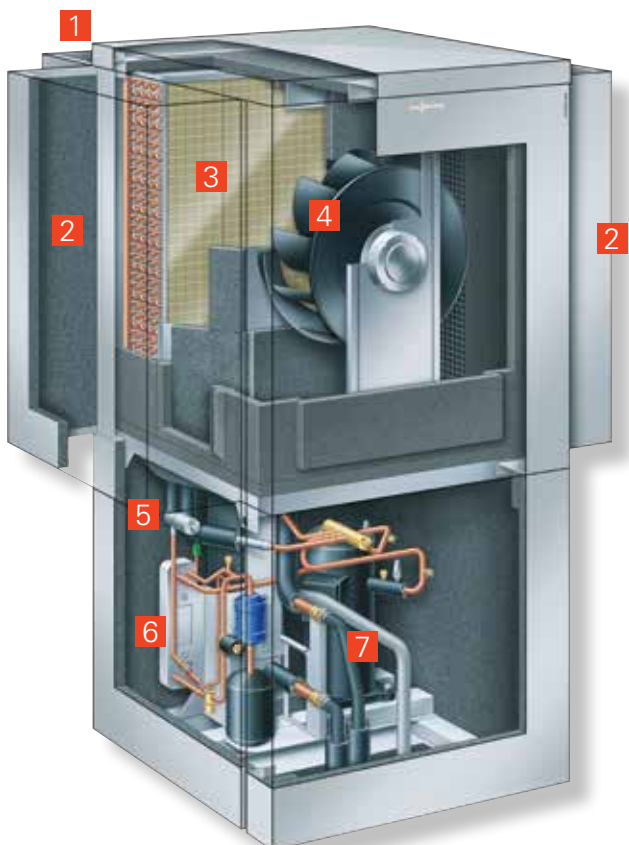
**VITOCAL 350-A**

- 1** Intake side
- 2** Discharge side
- 3** Evaporator
- 4** Radial fan
- 5** Electronic expansion valve
- 6** Heat exchanger for enhanced vapour injection
- 7** Hermetically sealed Compliant scroll compressor with enhanced vapour injection (EVI)

Ideal for modernisation

The Vitocal 350-A air source heat pump with rated heating output levels from 10.6 to 18.5 kW is particularly suitable for modernisation. Thanks to enhanced vapour injection in the compression process (EVI cycle), flow temperatures as high as 65°C can be achieved – even at wintry outside temperatures. This means the Vitocal 350-A is also suitable for installation in older heating systems with radiators. To raise efficiency, we recommend replacing individual radiators with ultra-low temperature ones.

The Vitotronic 200 heat pump control unit has an integral cascade function for up to five air source heat pumps. Heating output levels of up to 92.5 kW are therefore possible to cover higher heat demands.

High DHW convenience

Subject to system version, a higher flow temperature enables a water temperature of up to 55°C inside the DHW cylinder. This allows the Vitocal 350-A to deliver a particularly high level of DHW convenience. The Vitocal 350-A achieves its high flow temperature of 65°C even at outside temperatures as low as –10°C.

RCD system for particularly high efficiency

The electronic expansion valve and RCD (refrigerant cycle diagnostic) system also ensure an extremely high level of efficiency for the Vitocal 350-A all year round. It delivers a high COP of up to 3.6 (to EN 14511 at A2/W35). This results in high annual coefficients of performance and very low operating costs.

Space saving installation

The Vitocal 350-A can be installed either indoors or outdoors. The three-stage radial fan in the heat pump, as well as the flow-optimised air routing and the sound insulated casing together make the Vitocal 350-A extremely quiet. During night operation the multi stage fan control unit reduces the fan speed, and thus noise emissions, even further.



Vitocal 350-A for indoor installation

TAKE ADVANTAGE OF THESE BENEFITS

- + Air source heat pump, monovalent operation with heating output from 10.6 to 18.5 kW for DHW and central heating
- + Flow temperature: up to 65°C
- + Low operating costs thanks to high coefficient of performance (COP) to EN 14511 of up to 3.6 (A2/W35)
- + Matched product accessories for quick and easy hydraulic connection
- + Efficient defrosting through circuit reversal
- + With integral energy statement

For specification, see page 44

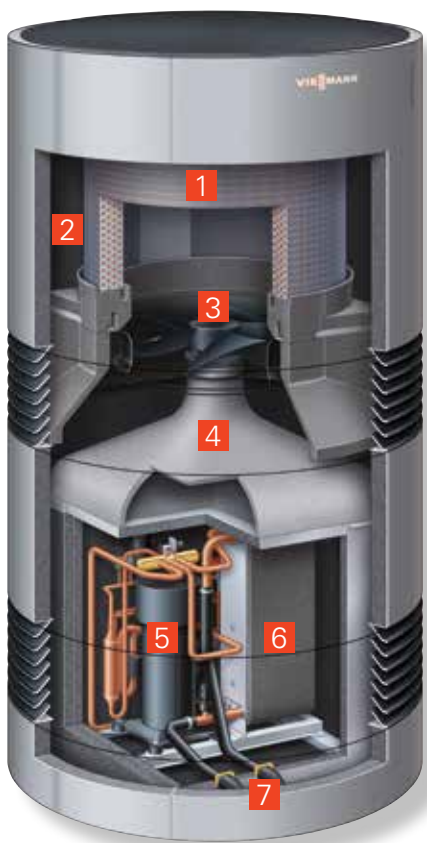
**VITOCAL 300-A**

- 1** Coated evaporator
- 2** Sheath current air routing
- 3** Variable speed EC fan
- 4** Flow optimisation
- 5** Variable speed scroll compressor
- 6** Condenser
- 7** Hydraulic connections

VITOCAL 300-A

5.8 to 13.4 kW

The Vitocal 300-A air source heat pump stands out not only on account of its contemporary design. With a maximum flow temperature of 65°C for central heating and convenient DHW heating, this appliance is particularly suitable for modernising detached and semi-detached houses.

Flexible and quiet

The Vitocal 300-A air source heat pump is installed outside the building and utilises free ambient air. Thanks to its variable speed DC fan, modulating compressor and sound-optimised design with sheath current air routing, the heat pump is exceptionally quiet, with a sound power level below 54 dB(A). The fan speed can also be reduced at night.

High COP for reliable heat supply

The variable speed scroll compressor with brushless permanent magnet motor and vapour injection, as well as the electronic bi-flow expansion valve, contribute to the high COP to EN 14511 of up to 5.0 (A7/W35).

Vapour injection improves efficiency, particularly at high flow temperatures. The Vitocal 300-A provides a reliable heat supply and considerably reduces electricity costs, most notably in partial load operation.

Easy cooling in summer

The Vitocal 300-A is capable of reversible operation to provide cooling during the warmer months. When high temperatures occur in summer, convectors or surface cooling systems make the interior feel comfortably cool.

Wireless or app operation

The Vitocal 300-A is equipped with the Vitotronic 200 control unit (type WO1C). It is preset for wireless remote operation and allows convenient control from the living space. In conjunction with the ViCare app and Vitoconnect, the system can also be controlled from anywhere via a smartphone or tablet.

Prepared for operation with photovoltaic power and Smart Grid

Connecting to a photovoltaic system enables further savings on operating costs. The power generated on site can, for example, be used to run the Vitocal 300-A. The Vitocal 300-A is also prepared for Smart Grid applications (intelligent integration of consumers in power grids).



Energy efficiency label
Vitocal 300-G, BW 301.A21



The Vitocal 300-A meets the requirements of the EHPA Quality Label.



The Vitocal 300-A air source heat pump received the German Design Award SPECIAL MENTION 2015 in the 'Excellent Product Design – Building and Energy' category.

TAKE ADVANTAGE OF THESE BENEFITS

- + Reversible air source heat pump for heating and cooling, for outdoor installation
- + Rated heating output: 5.8 and 13.4 kW at A2/W35
- + Low operating costs thanks to high coefficient of performance (COP) to EN 14511: up to 5.0 at A7/W35 and 4.0 at A2/W35
- + Flow temperature: up to 65°C at –5°C outside temperature
- + Low operating noise thanks to sound-optimised DC fan, reduced fan speed in night mode and sound-optimised appliance design
- + Optional control and monitoring with wireless remote control units or ViCare app
- + Prepared for Smart Grid and optimised utilisation of power generated on site

For specification, see page 45



VITOCAL 200-A INDOOR UNIT

- 1 Instantaneous heating water heater
- 2 3-way diverter valve for central heating/DHW heating
- 3 Secondary pump (high efficiency circulation pump)
- 4 Vitotronic 200 control unit
- 5 Flow switch

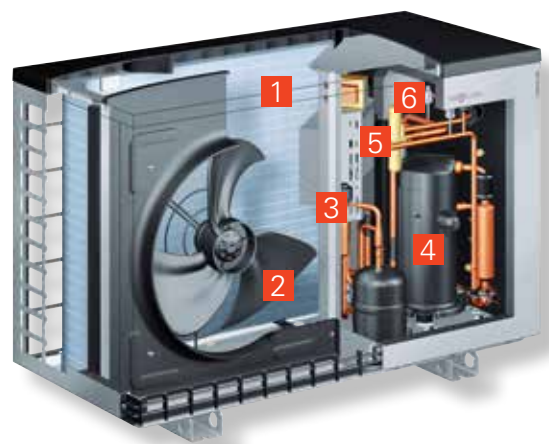

OUTDOOR UNIT

- 1 Coated evaporator with corrugated fins for higher efficiency
- 2 Power saving, variable speed DC fan
- 3 Electronic expansion valve (EEV)
- 4 Variable speed scroll compressor
- 5 4-way diverter valve
- 6 Condenser

Air source heat pumps with a monobloc design are characterised by separation into an indoor unit and an outdoor unit, with water-carrying connection lines.

The Vitocal 200-A monobloc heat pump utilises the latent heat in the outdoor air for environmentally responsible and cost effective heating. It is available either solely for heating or for heating and cooling.

Compact monobloc outdoor units

These outdoor units in their timeless design are very easy on the eye. These appliances with one or two fans are designed and manufactured in-house. Consequently, they offer very good performance data, an excellent finish and superb product quality – Made in Germany.

Especially quiet outdoor unit for this range

The acoustic properties of the outdoor units for the Vitocal monobloc heat pumps comply with advanced acoustic design (AAD) specifications. This involves optimising the frequency spectrum so that low sounds are shifted into a higher frequency range. There, they are perceived as less of a nuisance and can be better absorbed by the building substance.

The Vitocal 200-A is particularly well suited to densely built-up areas, such as terraced housing.

Quick installation; certificate of competence not required

The compact, wall mounted indoor unit, complete with hydraulics and control unit, is quiet and can be installed near the living space. The lines running to the outdoor unit can be filled with water. This requires no certificate of competence (refrigerant certificate) for the installer. The high degree of pre-assembled components and coordinated accessories means the Vitocal 200-A can be installed very quickly.

Dual mode operation with an existing system

When it comes to modernisation, the heat pump is ideally suited to dual mode operation. In this case the existing system remains operational to cover peak loads when temperatures are particularly low. This significantly improves system efficiency.

Vitotronic 200 with WLAN option

The heat pumps can even be controlled from anywhere using the Vitotronic 200 control unit via the Vitoconnect web interface (accessory) and the free ViCare app. In addition, they can be combined with Vitovent central mechanical ventilation units.



The Vitocal 200-A meets the requirements of the EHPA Quality Label.



The Vitocal 200-A is KEYMARK certified.

TAKE ADVANTAGE OF THESE BENEFITS

- + Low operating costs thanks to high coefficient of performance (COP) to EN 14511: up to 4.72 (A7/W35) and 4.01 (A2/W35)
- + Rated heating output: 2.3 to 11.8 kW at A2/W35
- + Heating and cooling with a single appliance thanks to reversible circuit
- + Especially quiet thanks to advanced acoustic design (AAD), ideal for use in terraced housing
- + High product quality and a modern, timeless design – Made in Germany
- + Maximum flow temperature up to 60°C
- + Monobloc indoor unit with high efficiency circulation pump, 3-way diverter valve and control unit; the heating/cooling version also has an instantaneous heating water heater



VITOCAL 222-A INDOOR UNIT

- 1** Instantaneous heating water heater
- 2** 3-way diverter valve for central heating/
DHW heating
- 3** Flow switch
- 4** Secondary pump
(high efficiency circulation pump)
- 5** Vitotronic 200 control unit
- 6** Enamelled DHW cylinder (220 litre capacity)

Air source heat pumps with a monobloc design are characterised by separation into an indoor unit and an outdoor unit, with water-carrying connection lines.

The Vitocal 222-A monobloc heat pump utilises the latent heat in the outdoor air for environmentally responsible and cost effective heating. It can provide heating and cooling. This compact appliance also includes an integral 220 litre DHW cylinder.

Innovative advanced acoustic design

The acoustic properties of the outdoor units for the Vitocal 222-A comply with advanced acoustic design (AAD) specifications. The result is barely audible. In conjunction with intelligent speed control, the high grade, sound-optimised fan significantly contributes to reducing airborne noise in full and partial load operation. Low frequencies that are generally perceived as a nuisance in conventional heat pumps are largely prevented.

Particularly quiet

With a sound pressure level of only 35 dB(A) at a distance of three metres (night mode), the outdoor unit (with a fan) of the new Vitocal 222-A compact air source heat pump is one of the quietest units of its kind. Installation close to a neighbouring property or in densely built-up areas, such as terraced housing estates, is therefore no problem.

Quick installation; certificate of competence not required

The compact, wall mounted indoor unit, complete with hydraulics and control unit, is quiet and can be installed near the living space. The lines running to the outdoor unit are filled with water, so the installer does not require a special certificate of competence (refrigerant certificate). The high degree of pre-assembled components and coordinated accessories means the Vitocal 222-A can be installed very quickly.

High DHW convenience

The Vitocal 222-A includes a large, integral 220 litre DHW cylinder. The newly developed inlet system ensures very good stratification, which allows a high draw-off volume of up to 290 litres (at 40°C).

Vitotronic 200 with WLAN option

The heat pump can even be controlled remotely with the Vitotronic 200 control unit via the Vitoconnect internet interface (accessory) and the free ViCare app. In addition, it can be combined with Vitovent central mechanical ventilation units.



Display of the Vitotronic 200 heat pump control unit

TAKE ADVANTAGE OF THESE BENEFITS

- + Low operating costs thanks to high coefficient of performance (COP) to EN 14511: up to 4.72 (A7/W35) and 4.01 (A2/W35)
- + Rated heating output: 2.3 to 11.8 kW at A2/W35
- + Heating and cooling with a single appliance thanks to reversible circuit
- + High DHW convenience thanks to 220 litre DHW cylinder
- + Especially quiet, thanks to advanced acoustic design (AAD), ideal for use in rows of terraced houses
- + High product quality and a modern, timeless design – Made in Germany
- + Maximum flow temperature up to 60°C at –10°C outside temperature
- + Monobloc indoor unit with high efficiency circulation pump, 3-way diverter valve, safety assembly, control unit and integral instantaneous heating water heater

For specification, see page 47



VITOCAL 222-G

Vitocal 222-G	Type	BWT 221.B06	BWT 221.B08	BWT 221.B10
Performance data (to EN 14511, B0/W35°C, 5 K spread)				
Rated heating output	kW	5.8	7.5	10.4
COP ξ in heating mode		4.6	4.6	4.8
Maximum flow temperature	°C	65	65	65
Refrigerant circuit				
Refrigerant		R410A	R410A	R410A
– Refrigerant charge	kg	1.4	1.95	2.4
– Global warming potential (GWP) ¹⁾		1924	1924	1924
– CO ₂ equivalent	t	2.7	3.8	4.6
Dimensions				
Length (depth) x width x height	mm	680 x 600 x 2000		
Cylinder capacity	litres	220	220	220
Maximum draw-off volume at draw-off temperature 40°C	litres	293	293	293
Coefficient of performance ξ (COP_{wh}) for DHW heating		3.14	3.14	3.14
Weight	kg	277	282	288
Energy efficiency class*		A ⁺⁺ / A ⁺	A ⁺⁺ / A ⁺	A ⁺⁺ / A ⁺
DHW heating:				
Draw-off profile		XL	XL	XL
Energy efficiency class		A ⁺	A ⁺	A ⁺

¹⁾ Based on the 5th Assessment Report of the Intergovernmental Panel on Climate Change (IPCC)

* Energy efficiency class in line with Commission Regulation (EU) No. 813/2013 regarding heating under average climate conditions for low (W35)/medium (W55) temperature applications
The new energy efficiency class A⁺⁺⁺ comes into effect on 26 September 2019.



VITOCAL 300-G (BRINE/WATER)

Vitocal 300-G Brine/water	Type	BW/BWC/BWS 301.B06	BW/BWC/BWS 301.B08	BW/BWC/BWS 301.B10	BW/BWC/BWS 301.B13	BW/BWC/BWS 301.B17
Performance data (to EN 14511, B0/W35°C, 5 K spread)						
Rated heating output	kW	5.7	7.6	10.4	13.0	17.2
COP & in heating mode		4.6	4.7	5.0	5.0	4.7
Maximum flow temperature	°C	65	65	65	65	65
Refrigerant circuit						
Refrigerant		R410A	R410A	R410A	R410A	R410A
– Refrigerant charge	kg	1.40	1.95	2.40	2.25	2.75
– Global warming potential (GWP)		2088	2088	2088	2088	2088
– CO ₂ equivalent	t	2.9	4.1	5.0	4.7	5.7
Dimensions						
Length (depth)	mm	845	845	845	845	845
Width	mm	600	600	600	600	600
Height (programming unit open)	mm	1049	1049	1049	1049	1049
Weight						
Type BW	kg	113	117	129	135	148
Type BWC	kg	123	127	139	145	158
Type BWS	kg	109	113	125	131	144
Energy efficiency class*		A++ / A++	A++ / A++	A++ / A++	A++ / A++	A++ / A++



Master/slave pack each with the same rated heating output	Type	BW/BWS 301.B06	BW/BWS 301.B08	BW/BWS 301.B10	BW/BWS 301.B13	BW/BWS 301.B17
Performance data (to EN 14511, B0/W35°C, 5 K spread)						
Rated heating output	kW	11.4	15.2	20.8	26.0	34.4

VITOCAL 300-G (WATER/WATER)

Vitocal 300-G Water/water	Type	BW/BWC/BWS 301.B06	BW/BWC/BWS 301.B08	BW/BWC/BWS 301.B10
Performance data (to EN 14511, B0/W35°C, 5 K spread)				
Rated heating output	kW	7.5	10.2	13.5
COP & in heating mode		6.1	6.6	6.6
Maximum flow temperature	°C	65	65	65



VITOCAL 200-G

Vitocal 200-G	Type	BWC 201.A06	BWC 201.A08	BWC 201.A10
Performance data (to EN 14511, B0/W35°C, 5 K spread)				
Rated heating output	kW	5.6	7.5	9.7
COP & in heating mode		4.1	4.4	4.3
Maximum flow temperature	°C	60	60	60
Refrigerant circuit				
Refrigerant		R410A	R410A	R410A
– Refrigerant charge	kg	1.20	1.45	1.70
– Global warming potential (GWP)		2088	2088	2088
– CO ₂ equivalent	t	2.5	3.0	3.6
Dimensions				
Length (depth)	mm	845	845	845
Width	mm	600	600	600
Height (control unit open)	mm	1049	1049	1049
Weight				
	kg	113	117	129
Energy efficiency class*		A++ / A++	A++ / A++	A++ / A++

* Energy efficiency class as per Regulation (EU) No. 811/2013 regarding heating under average climate conditions for low (W35)/medium temperature applications (W55)



VITOCAL 350-G (BRINE/WATER)

Vitocal 350-G (single stage, master)	Type	BW 351.B20	BW 351.B27	BW 351.B33	BW 351.B42
Vitocal 350-G (2-stage, slave without own control unit)	Type	BWS 351.B20	BWS 351.B27	BWS 351.B33	BWS 351.B42
Performance data (to EN 14511, B0/W35°C, 5 K spread)					
Rated heating output	kW	20.5	28.7	32.7	42.3
COP ξ in heating mode		4.8	4.9	5.0	4.8
Maximum flow temperature (5 K/12 K spread)	°C	65/70	65/70	65/70	65/70
Refrigerant circuit					
Refrigerant		R410A	R410A	R410A	R410A
– Refrigerant charge	kg	5.5	7.3	9.0	9.25
– Global warming potential (GWP)		2088	2088	2088	2088
– CO ₂ equivalent	t	11.5	15.2	18.8	19.3
Dimensions					
Length (depth)	mm	1085	1085	1085	1085
Width	mm	780	780	780	780
Height (control unit open)	mm	1267	1267	1267	1267
Weight					
Type BW	kg	270	285	310	315
Type BWS	kg	265	280	305	310
Energy efficiency class*		A++ / A++	A++ / A++	A++ / A++	A++ / A++

VITOCAL 350-G (WATER/WATER)

Vitocal 350-G (single stage, master)	Type	BW 351.B20	BW 351.B27	BW 351.B33	BW 351.B42
Vitocal 350-G (2-stage, slave without own control unit)	Type	BWS 351.B20	BWS 351.B27	BWS 351.B33	BWS 351.B42
Performance data (to EN 14511, B0/W35°C, 5 K spread)					
Rated heating output	kW	25.4	34.7	42.2	52.3
COP ξ in heating mode		5.7	6.1	6.2	5.8
Maximum flow temperature (5 K/12 K spread)	°C	65/70	65/70	65/70	65/70



VITOCAL 300-G (BRINE/WATER)

Vitocal 300-G	Type	BW 301.A21	BW 301.A29	BW 301.A45
Vitocal 300-G	Type	BWS 301.A21	BWS 301.A29	BWS 301.A45
Performance data (to EN 14511, B0/W35°C, 5 K spread)				
Rated heating output	kW	21.2	28.8	42.8
COP ξ in heating mode		4.7	4.8	4.6
Maximum flow temperature	°C	60	60	60
Refrigerant circuit				
Refrigerant		R410A	R410A	R410A
– Refrigerant charge	kg	4.7	6.2	7.7
– Global warming potential (GWP)		2088	2088	2088
– CO ₂ equivalent	t	11.5	13.0	16.1
Dimensions				
Length (depth)	mm	1085	1085	1085
Width	mm	780	780	780
Height	mm	1267	1267	1267
Weight				
Type BW	kg	245	272	298
Type BWS	kg	240	267	293
Energy efficiency class*		A++ / A++	A++ / A++	A++ / A++

VITOCAL 300-G (WATER/WATER)

Vitocal 300-G	Type	BW 301.A21	BW 301.A29	BW 301.A45
Vitocal 300-G	Type	BWS 301.A21	BWS 301.A29	BWS 301.A45
Performance data (to EN 14511, B0/W35°C, 5 K spread)				
Rated heating output	kW	28.1	37.1	58.9
COP ξ in heating mode		5.9	6.0	5.5
Maximum flow temperature (5 K/12 K spread)	°C	60	60	60

* Energy efficiency class as per Regulation (EU) No. 811/2013 regarding heating under average climate conditions for low (W35)/medium temperature applications (W55)



NATURAL COOLING NC-BOX

Performance data

Cooling capacity subject to the heat pump output
for Vitocal 343-G/333-G/300-G/242-G/222-G/200-G

kW	Approx. 1.25 – 5.0
----	--------------------

Dimensions

Length (depth)	mm	520
Width	mm	580
Height	mm	420

Weight incl. mixer	kg	28
---------------------------	----	----



ACTIVE COOLING AC-BOX

The maximum cooling capacity is limited by the integral heat pump

(for Vitocal 300-G, type BWC/BW 301.B06-17)

Dimensions

Length (depth)	mm	717
Width	mm	350
Height	mm	973

Weight	kg	80
---------------	----	----



VITOCAL 350-A

Vitocal 350-A (outdoor installation)	Type	AWHO 351.A10	AWHO 351.A14	AWHO 351.A20
Vitocal 350-A (indoor installation)	Type	AWHI 351.A10	AWHI 351.A14	AWHI 351.A20
Performance data (to EN 14511, A2/W35°C)				
Rated heating output	kw	10.6	14.5	18.5
Power consumption	kW	2.9	4.2	5.8
COP ξ in heating mode		3.6	3.5	3.2
Maximum flow temperature	°C	Up to 65	Up to 65	Up to 65
Refrigerant circuit				
Refrigerant		R407C	R407C	R407C
– Refrigerant charge	kg	4.0	4.5	5.2
– Global warming potential (GWP)		1774	1774	1774
– CO ₂ equivalent	t	7.1	8.0	9.2
Dimensions (outdoor installation)				
Length (depth)	mm	1265	1265	1265
Width	mm	1380	1530	1700
Height	mm	1885	1885	1885
Dimensions (indoor installation)				
Length (depth)	mm	946	946	946
Width	mm	880	1030	1200
Height	mm	1870	1870	1870
Weight				
Outdoor installation	kg	325	335	400
Indoor installation	kg	287	297	361
Energy efficiency class*		A++ / A+	A+ / A+	A+ / A+

* Energy efficiency class as per Regulation (EU) No. 813/2013 regarding heating under average climate conditions for low (W35)/medium temperature applications (W55)



VITOCAL 300-A

Vitocal 300-A, type AWO-AC	Type	301.B07	301.B11	301.B14
Performance data				
Rated heating output				
Operating point A2/W35 (to EN 14511)	kW	7.4	7.0	8.5
Operating point A-7/W35 (to EN 14511)	kW	7.0	10.5	12.0
Output range min./max.	kW	5.8 – 9.7	5.8 – 12.0	7.2 – 13.4
Coefficient of performance ϵ (COP) A2/W35		4.0	3.9	3.9
Coefficient of performance ϵ (COP) A7/W35		5.0	5.0	5.0
Rated cooling capacity				
Operating point A35/W18 (to EN 14511)	kW	8.1	8.1	9.0
Maximum flow temperature				
	°C	Up to 65	Up to 65	Up to 65
Sound power level				
Min./max./night mode	dB(A)	49/53/51	49/53/51	50/54/52
Operating point A7/W55				
Refrigerant circuit				
Refrigerant		R410A	R410A	R410A
– Refrigerant charge	kg	4.75	4.75	4.75
– Global warming potential (GWP)		2088	2088	2088
– CO ₂ equivalent	t	9.9	9.9	9.9
Total dimensions				
Length (depth) x width x height	mm	1100 x 1100 x 1980		
Weight				
	kg	250	250	250
Energy efficiency class*				
		A++/A++	A++/A++	A++/A++

* Energy efficiency class as per Regulation (EU) No. 813/2013 regarding heating under average climate conditions for low (W35)/medium temperature applications (W55)



VITOCAL 200-A MONOBLOC VERSION

Vitocal 200-A	Type	AWO-M/AWO-M-E-AC					
		201.A04	201.A06	201.A08	201.A010	201.A13	201.A16
Voltage	V	230	230	230	230	230	230
Performance data – heating (to EN 14511, A2/W35)							
Rated heating output	kW	2.6	3.1	4.0	5.0	5.9	6.5
COP ξ in heating mode		3.6	3.8	4.0	4.0	4.0	3.6
Output control	kW	2.3 – 4.2	3.0 – 5.7	3.5 – 7.0	4.0 – 9.5	4.5 – 10.3	5.0 – 11.8
Performance data – heating (to EN 14511 A7/W35, 5 K spread)							
Rated heating output	kW	4.0	4.8	5.6	7.0	7.8	8.6
COP ξ in heating mode		4.6	4.7	4.7	4.7	4.7	4.5
Output control	kW	3.2 – 5.7	3.8 – 6.6	4.6 – 8.5	5.0 – 12.6	5.0 – 13.7	5.5 – 14.3
Performance data – heating (to EN 14511 A-7/W35, 5 K spread)							
Rated heating output	kW	3.8	5.7	6.7	8.7	9.5	11.0
COP ξ in heating mode		2.9	2.9	2.9	3.1	3.1	2.8
Performance data – cooling (to EN 14511 A35/W18)							
Rated cooling capacity	kW	4.5	4.9	5.4	6.0	7.4	9.5
EER in cooling mode		3.4	3.6	3.8	3.6	3.7	3.4
Dimensions (outdoor unit)							
Length (depth)	mm	546	546	546	546	546	546
Width	mm	1109	1109	1109	1109	1109	1109
Height	mm	753	753	753	1377	1377	1377
Dimensions (indoor unit)							
Length (depth) x width x height	mm	370 x 450 x 880					
Weight							
Outdoor unit	kg	102	102	103	145	153	153
Indoor unit type AWO-M-E-AC, AWO-E-AC	kg	41	41	41	41	41	41
Refrigerant circuit							
Refrigerant		R410A	R410A	R410A	R410A	R410A	R410A
– Refrigerant charge	kg	1.4	1.4	1.4	2.4	2.4	2.4
– Global warming potential (GWP)		2088	2088	2088	2088	2088	2088
– CO ₂ equivalent	t	2.9	2.9	2.9	5.0	5.0	5.0
Energy efficiency class*		A++ / A+	A++ / A++	A++ / A++	A++ / A++	A++ / A++	A++ / A++

* Energy efficiency class as per Regulation (EU) No. 813/2013 regarding heating under average climate conditions for low (W35)/medium temperature applications (W55)



VITOCAL 222-A MONOBLOC VERSION

Vitocal 222-A	Type	AWOT-M-E / AWOT-M-E-AC					
		221.A04	221.A06	221.A08	221.A10	221.A13	221.A16
Voltage	V	230	230	230	230	230	230
Performance data – heating (to EN 14511, A2/W35)							
Rated heating output	kW	2.6	3.1	4.0	5.0	5.9	6.5
COP & in heating mode		3.6	3.8	4.0	4.0	4.0	3.6
Output control	kW	2.3 – 4.2	3.0 – 5.7	3.5 – 7.0	4.0 – 9.5	4.5 – 10.3	5.0 – 11.8
Performance data – heating (to EN 14511, A-7/W35)							
Rated heating output	kW	3.8	5.7	6.7	8.7	9.5	11.0
COP & in heating mode		2.9	2.9	2.9	3.1	3.1	2.
Performance data – cooling (to EN 14511, A35/W18)							
Rated cooling capacity	kW	4.5	4.9	5.4	6.0	7.4	9.5
EER in cooling mode		3.4	3.6	3.8	3.6	3.7	3.4
Refrigerant circuit							
Refrigerant		R410A	R410A	R410A	R410A	R410A	R410A
– Refrigerant charge	kg	1.4	1.4	1.4	2.4	2.4	2.4
– Global warming potential (GWP)		2088	2088	2088	2088	2088	2088
– CO2 equivalent	t	2.9	2.9	2.9	5.0	5.0	5.0
Cylinder capacity	litres	220	220	220	220	220	220
Assessed total sound power level at A7/W55 in night mode							
	dB(A)	50	50	50	55	55	55
Dimensions (indoor unit)							
Length (depth) x width x height	mm	681 x 600 x 1874					
Dimensions (outdoor unit)							
Length (depth)	mm	546	546	546	546	546	546
Width	mm	1109	1109	1109	1109	1109	1109
Height	mm	753	753	753	1377	1377	1377
Weight							
Indoor unit	kg	164	164	164	164	164	164
Outdoor unit	kg	102	102	103	145	145	145
Energy efficiency class*		A+ / A++	A++ / A++	A++ / A++	A++ / A++	A++ / A++	A++ / A++
Draw-off profile		L	L	L	L	L	L
Efficiency class		A	A	A	A	A	A

* Energy efficiency class as per Regulation (EU) No. 813/2013 regarding heating under average climate conditions for low (W35)/medium temperature applications (W55)



System technology ensures reliable and economical operation

The convenient controls and perfectly matched Viessmann system components offer maximum reliability, flexibility and efficiency.

"The whole is greater than the sum of its parts." In accordance with this philosophy, Viessmann does not simply supply individual heating equipment components that meet the high Viessmann standards for quality, reliability and effectiveness. In addition, all products are part of a matching overall concept, where all components complement one another. After all, only perfect interaction between all system parts can draw out the maximum potential of our innovative leading technology.

Viessmann system technology incorporates everything you need for a reliable and economical heating system.

This includes the Vitotronic control unit with wireless remote control and online control using the ViCare app, powerful Vitocell DHW cylinders for the highest DHW convenience, and high grade photovoltaic systems.

EVERYTHING FROM A SINGLE SOURCE



OPERATING CONVENIENCE

Clear, convenient, intelligent: the Vitotronic offers perfect functionality for fast and precise control of any heating system.



CONNECTIVITY

With Vitoconnect and a smartphone, controlling Viessmann heating systems couldn't be easier. Heating systems can be controlled with the ViCare app (page 8/9). All apps are available for mobile devices running iOS or Android operating systems.



PHOTOVOLTAIC SYSTEMS

The sun supplies more power than we need. This is economical – generating solar power is already significantly cheaper than drawing domestic power from the grid.



MECHANICAL VENTILATION SYSTEMS

Controlled mechanical ventilation systems with heat recovery continuously replace the air in the living space and remove odours and noxious substances, for a healthy, comfortable indoor environment. And they do so in an extremely energy efficient way.



DHW CYLINDERS

DHW convenience for every demand: Vitocell DHW cylinders are convenient solutions for supplying a household with hot water – the perfect complement to any new heat pump.



SYSTEM ACCESSORIES

In addition to the high quality Viessmann products, we also offer system components from other well known manufacturers with the Vitoset range of accessories. Radiators, expansion vessels, pipework, pumps, filters and valves – Vitoset offers the complete range of accessories for your Viessmann heating system.

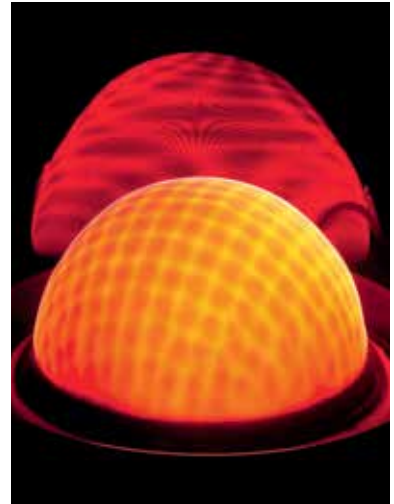

The company

Viessmann is one of the leading international manufacturers of efficient heating, industrial and refrigeration systems.

Sustainability in action

As a family business Viessmann takes the long view and places great value on acting responsibly; sustainability is firmly enshrined in the company's principles. For Viessmann, sustainability in action means striking a balance between economy, ecology and social responsibility throughout the company; meeting current needs without compromising the quality of life of future generations.

With its strategic sustainability project, Viessmann demonstrates at its own head office in Allendorf (Eder) that the energy and climate policy goals set by the German government for 2050 can in fact be achieved today with the help of commercially available technology.

The Viessmann comprehensive range

As environmental pioneer and technological trailblazer for the heating sector, Viessmann has for decades been supplying exceptionally clean and efficient systems for heating, refrigeration and decentralised power generation. Many of the company's developments are recognised as heating equipment milestones.

Practical partnership

As part of its comprehensive range, Viessmann also offers a wide selection of complementary services. These services include a comprehensive training and further development programme for trade partners at the well equipped training facilities of the Viessmann Academy.

With its new digital services, Viessmann offers innovative solutions such as the operation and monitoring of heating systems by smartphone. Users benefit from greater reassurance and convenience, whilst contractors can keep a constant eye on the systems for which they are responsible.



German Sustainability Award for Production/Brand/Resource Efficiency



Energy Efficiency Award

VISSMANN GROUP

Company details

- + Established in: 1917
- + Employees: 12,000
- + Group turnover: 2.5 billion euros
- + Export share: 54 percent
- + 23 production companies in 12 countries
- + 74 countries with sales companies and branches
- + 120 sales offices worldwide

Comprehensive range from the Viessmann Group

- + Boilers for oil or gas
- + Combined heat and power generation
- + Hybrid appliances
- + Heat pumps
- + Wood combustion technology
- + Plants for producing and upgrading biogas
- + Solar thermal
- + Photovoltaics
- + Electric heating and DHW systems
- + Refrigeration systems
- + Accessories

Viessmann Limited
Hortonwood 30, Telford
Shropshire, TF1 7YP
Tel: 01952 675000
Fax: 01952 675040
www.viessmann.co.uk

Your trade partner: