



Loose Goods Tables System P

"PS" loose goods tables: Powerful sales tools at the point of sale



"PS" loose goods tables are the fastest ever loose goods tables. From 0 to 100 % function in 30 seconds.

The sturdy "PS" means you can achieve your objective in record time – in case you need to react quickly at the point of sale or you want to present new goods in a more flexible manner.

That's because a "PS" loose goods table is easily assembled without tools in practically no time at all – and it takes up minimal space when stacked flat in your warehouse.



Int. patent registration PCT/DE02/02 800

Quick assembly ...



... for quicker sales!



Positioning goods for a sales promotion is now quicker and easier: Can be set up and folded down again in an instant, transported empty or full and stacked on top of one another in the warehouse without any problems.

In this brochure



Folding:
Loose goods tables
PS 12/8

Page 4



Classic:
Loose goods tables
P 12/8

Page 5



Table platforms:
More space to
display goods

Page 6

Ordering section
The Wanzl table range

Page 7
Page 8

Loose goods table PS 12/8 and PS 12/8 Duo

Flexible and assembled in a flash.

Loose goods tables to enhance your business. They can be set up very quickly without tools, and fold down again just as quickly if necessary. They can be stacked to save space and are available with or without castors.

Design

The table legs and tubes are made from square profile tubes, the edge mesh panels have a locking mechanism. A folding mechanism, so the tables can be folded down to save space. Base mesh panel hooks in at varying heights and is reinforced with flat iron bars. Version with castors: 4 swivel castors, with brakes.

Loose goods table PS 12/8 Duo:

With 1 partition mesh panel and 2 base mesh panels which can be hooked in at varying heights.

Finish

High-gloss chromium-plated



Safe stacking

The locking pins in the folding mechanism prevent slipping when transporting with a lift cart.



Loose goods table PS 12/8

1 m high, with base mesh panel that can be hooked in at varying heights. Max. volume 506 litres.



Version with castors

Loose goods table PS 12/8 Duo

With 1 partition mesh panel and 2 base mesh panels that can be hooked in at varying heights. Max. volume 506 litres.

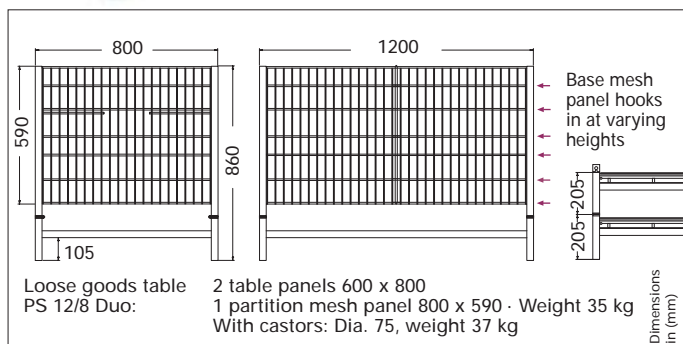
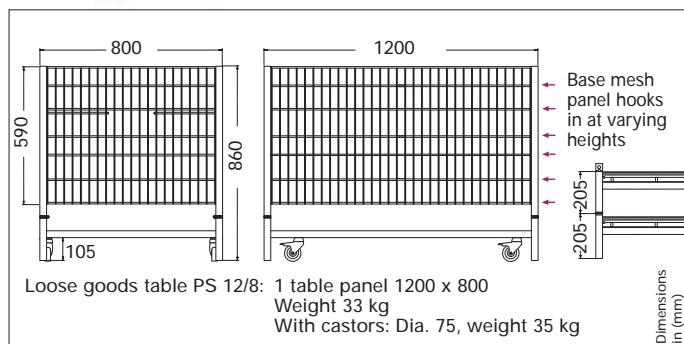

Loose goods table P 12/8 and P 12/8 Duo

A classic, tried-and-tested for years.

Universally applicable loose goods tables for many sectors and products. The base mesh panels with adjustable heights enable the tables to be optimally adjusted to different quantities of goods. Available with or without castors.

Design

The table legs and tubes are made from square profile tubes, the edge mesh panels are hooked in. Base mesh panel hooks in at varying heights and is reinforced with flat iron bars.

Version with castors: 4 swivel castors, with brakes.

Loose goods table P 12/8 Duo:

With 1 partition mesh panel and 2 base mesh panels which can be hooked in at varying heights.

Finish

High-gloss chromium-plated



Version with castors:

No loss of space when the tables are lined up next to one another. DGm 200 11 494.8

Information at the point of sale:



DIN A4 booklet holder
For inserting in the table leg. Booklet holder can be screwed on at the right or left. High-gloss chromium-plated finish.



DIN A4 poster holder, fixed
For attaching to the side mesh panels with hook points. High-gloss chromium-plated finish.

Suitable for all loose goods tables in the system „P“ range.



Loose goods table P 12/8

With 1 base mesh panel that can be hooked in at varying heights. Max. volume 331 litres.



Version with castors

Loose goods table P 12/8 Duo

With 1 partition mesh panel and 2 base mesh panels that can be hooked in at varying heights. Max. volume 331 litres.

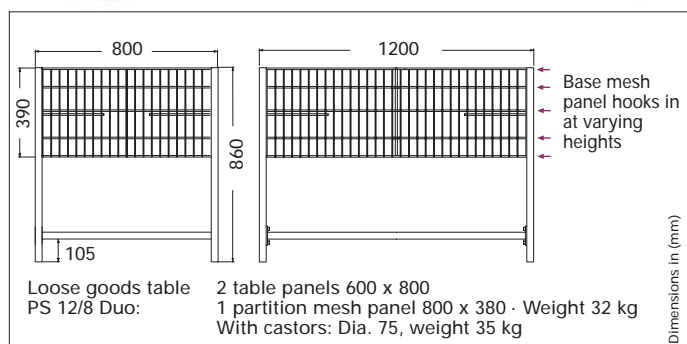
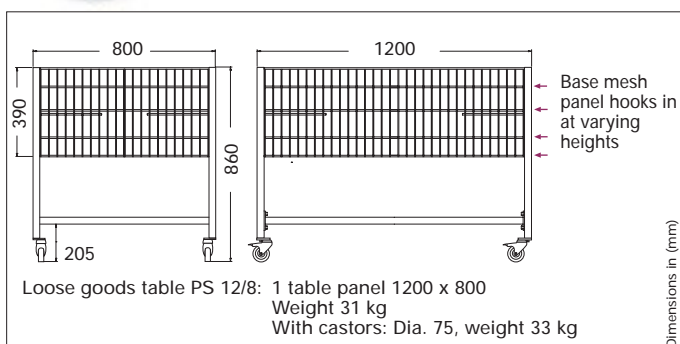

Table platforms

In the customer's field of view: A powerful sales tool offering you additional display area.

Design

Plug-in table platforms with close-mesh panels. Table platforms can be folded down for compact transport and storage.

Finish

High-gloss chromium-plated

Additional fittings

- Goods support panel
Attachment with 4 spring clips
- Decorative hoops
Plug-in with outline mesh
- Partition mesh panel
- DIN A4 poster holder
Plugs onto the goods support panel



Table platform folded down for space-saving storage.



Decorative hoop

Loose goods table PS 12/8 with TA9-440P table platform



Goods support panel

Loose goods table PS 12/8 with TA9-665P table platform

DIN A4 poster holder

Possible combinations

TA9-440P table platform



With decorative hoop

Assembly examples

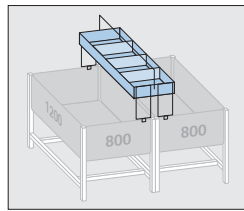

Over 2 tables

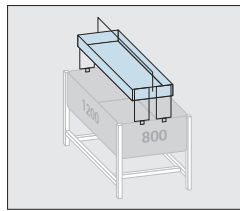

Over 1 table

Dimensions in mm

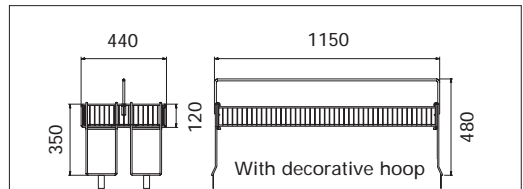

TA9-440P table platform: weight 6 kg

TA9-440P table platform



With partitions

Assembly examples

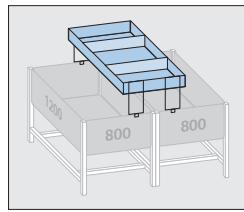

Over 2 tables

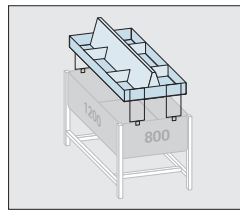

Over 1 table

Dimensions in mm

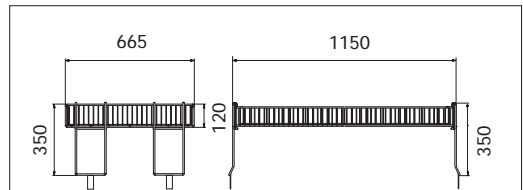

TA9-665P table platform: weight 8 kg

TA9-440P table platform



With goods support panel and poster holder

Assembly examples

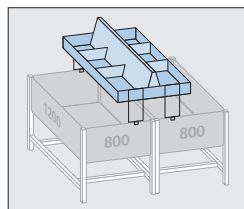

Over 2 tables

Dimensions in mm

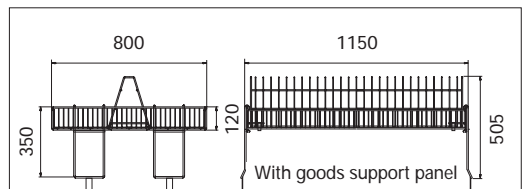

TA9-800P table platform: weight 10 kg

Ordering section

Loose goods tables system P

















	Folding		Classic	
Model	PS 12/8	PS 12/8 Duo	P 12/8	P 12/8 Duo
Order no. - Without castors	10.47 460.10	10.50 737.10	10.41 815.10	10.05 650.10
Order no. - With castors	10.55 707.10	10.55 713.10	10.02 599.10	10.50 963.10
Accessories				
 Partition 800 x 590 mm	27.03 616.10	standard	-	-
 Partition 800 x 380 mm	27.01 470.10	27.01 470.10	27.01 470.10	standard
 Partition 800 x 180 mm	27.52 796.10	27.52 796.10	27.52 796.10	27.52 796.10
 Partition 1200 x 180 mm	27.00 005.10	-	27.00 005.10	-
 DIN A4 brochure holder - Brochure holder can be screwed on at right or left	12.00 008.10	12.00 008.10	12.00 008.10	12.00 008.10
 DIN A4 poster holder, fixed - Landscape poster insert Portrait poster insert	21.32 884.10  21.32 883.10 	21.32 884.10  21.32 883.10 	21.32 884.10  21.32 883.10 	21.32 884.10  21.32 883.10 

Table platforms TA 9

	TA9-440P	TA9-665P	TA9-800P
Model	TA9-440P	TA9-665P	TA9-800P
Order no.	10.99 405.10	10.99 404.10	10.99 403.10
Accessories			
 Goods support panel	-	10.74 453.10	10.74 453.10
 Decorative hoop	10.83 920.10	10.83 920.10	10.83 920.10
 Partition 300 x 90 mm for table platform with goods support panel	-	-	27.83 922.10
 Partition 235 x 90 mm for table platform with goods support panel	-	27.83 923.10	-
 Partition 770 x 95 mm for table platform without goods support panel	-	-	27.83 919.10
 Partition 635 x 95 mm for table platform without goods support panel	-	27.83 920.10	-
 Partition 410 x 95 mm for table platform with or without decorative hoop	27.83 921.10	-	-
 DIN A4 poster holder for attachment to goods support panel	-	21.01 243.10  	21.01 243.10  

 **DIN A4**
Poster holder 320

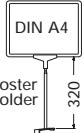
When ordering poster holders, please specify the required colour.
E.g. flame red RAL 3000
Order no. 21.01 243.10  Colour code

Colours for poster holders

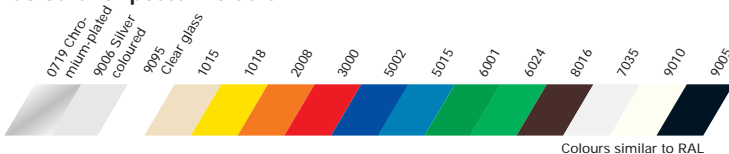

**More information =
More sales!**
We can send you our
complete literature on
request.

The Wanzl table range: The right basis for successful sales

If you want to win customers, you've got to present your goods in a convincing way. Wanzl as your system partner offers you a wide range of products which can be used for successfully promoting sales in all areas. Make sure you start out with the right basis for your future success – built on tables and sales systems from Wanzl.



"Design 99" loose goods tables



"Table" loose goods table system



Individual versions of loose goods tables



"Plaza" table system



The full range of Wanzl tables. Ask for your copy!



"Plaza" table system with platform

European patent registration
EP 1 023 857 A1



Germany: Wanzl Metallwarenfabrik GmbH
Bubesheimer Straße 4 · 89340 Leipheim
Tel. +49 (0) 82 21 / 729-0 · Fax +49 (0) 82 21 / 729-100
E-Mail info@wanzl.de · www.wanzl.com

Great Britain: Wanzl Ltd.
Europa House · Heathcote Lane · Warwick CV 34 6 SP
Tel. +44 (0) 19 26 / 45 19 51 · Fax +44 (0) 19 26 / 45 19 52
E-Mail enquiries@wanzl.co.uk · www.wanzl.com

Australia: Wanzl Australia Pty. Ltd.
97 Highbury Road · BURWOOD VIC 3125
Tel. +61 (0) 3 / 98 08 22 99 · Fax +61 (0) 3 / 98 08 22 66
E-Mail info@wanzl.com.au · www.wanzl.com

DB · 6/2003 · Dimensions in mm, stated dimensions approximate, colours similar to RAL, subject to design modifications.
© Copyright by Wanzl

Loose Goods Tables System P

Brochure no. 588/2003-GB