

# ALU Ranger OneR

CNC Panel Router with Vertical Table

4221

6321



CNC panel router with **Vertical Table**  
for architectural facades panels processing

**CNC panel router made for: ACM/ACP, ACM Mineral core, solid aluminium, panels with alu honeycomb and corrugated core, Fibrecement, HPL.**

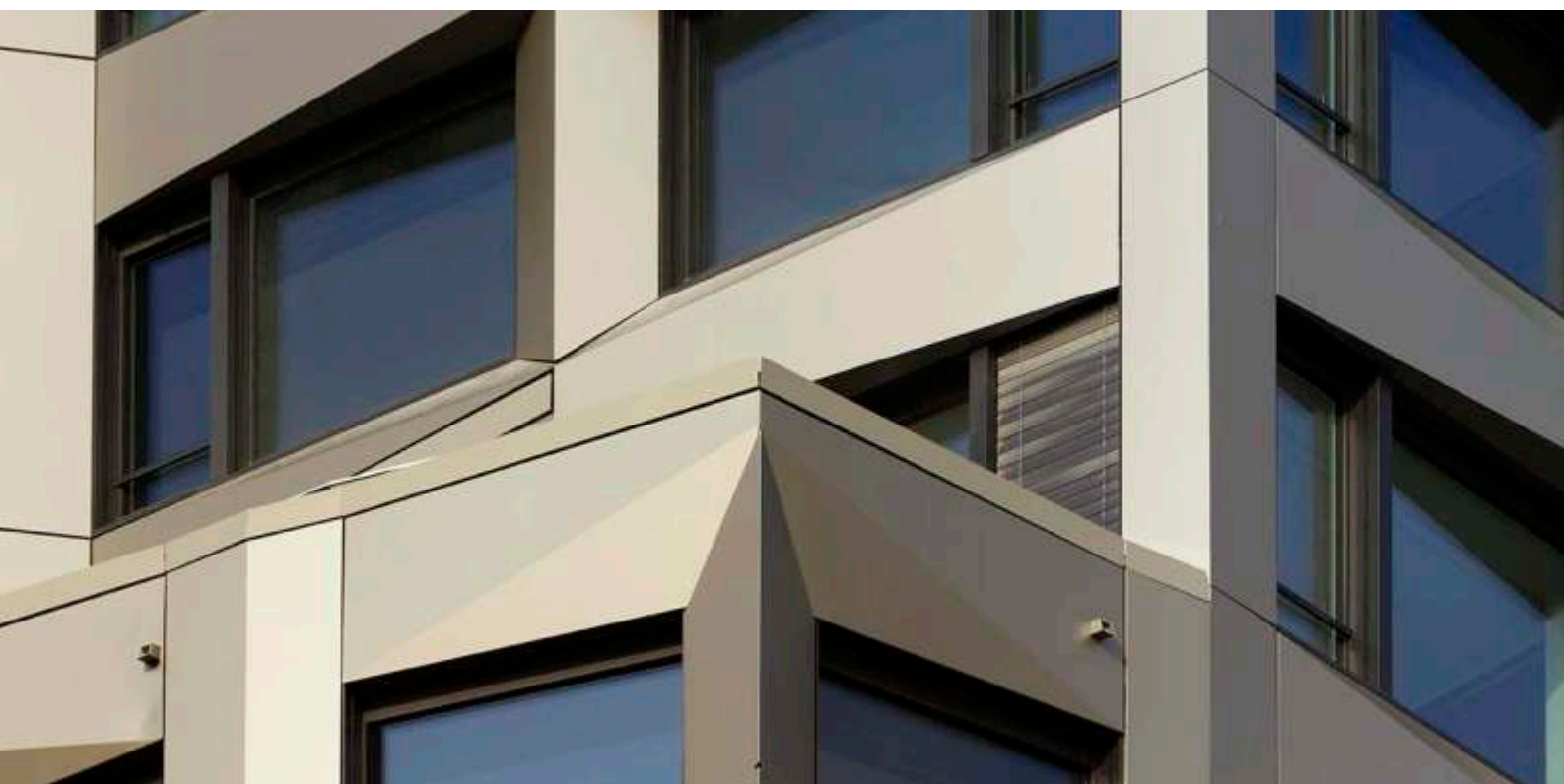

# ALU RANGER

## COMPATIBLE PANELS

### ACM / ACP PE CORE MINERAL CORE

ALUCOBOND®  
LARSON®  
ALPOLIC®  
ARCONIC®  
ALUBOND®  
ALBOND®  
SIBALUX®  
VITRABOND®  
STACBOND®  
ALUPANEL®  
NEOBOND®  
.....

### SOLID ALU

VITRADUAL®  
LUXE COAT®  
ALUCOLUX®  
FUTURAL®  
.....

### ALU HONEYCOMB

ALUCORE®  
LARCORE®  
PLASCORE®  
STARCELL®  
CELCOMPONENTS®  
HONYLITE®  
.....

### ALUMINIUM CORRUGATED CORE

METAWELL®  
DOLUFLEX®  
.....

### FIBER CEMENT

CEMBRIT®  
EQUITONE®  
COPANEL®  
SWISS PEARL®  
.....

### HPL

TRESPA®  
MAX EXTERIOR®  
POLYREY®  
RESOPAL®  
FUNDERMAX®  
.....

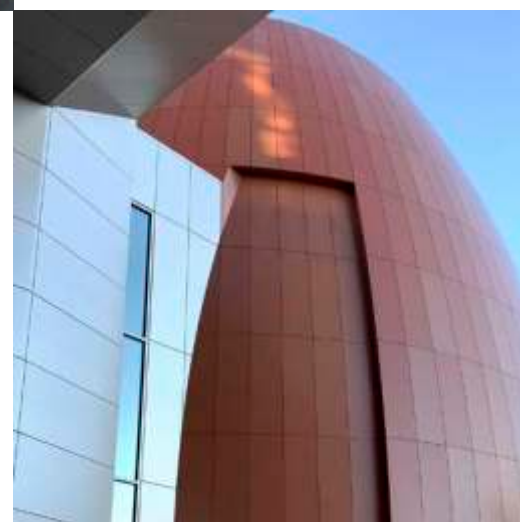



# NO WASTED SPACE

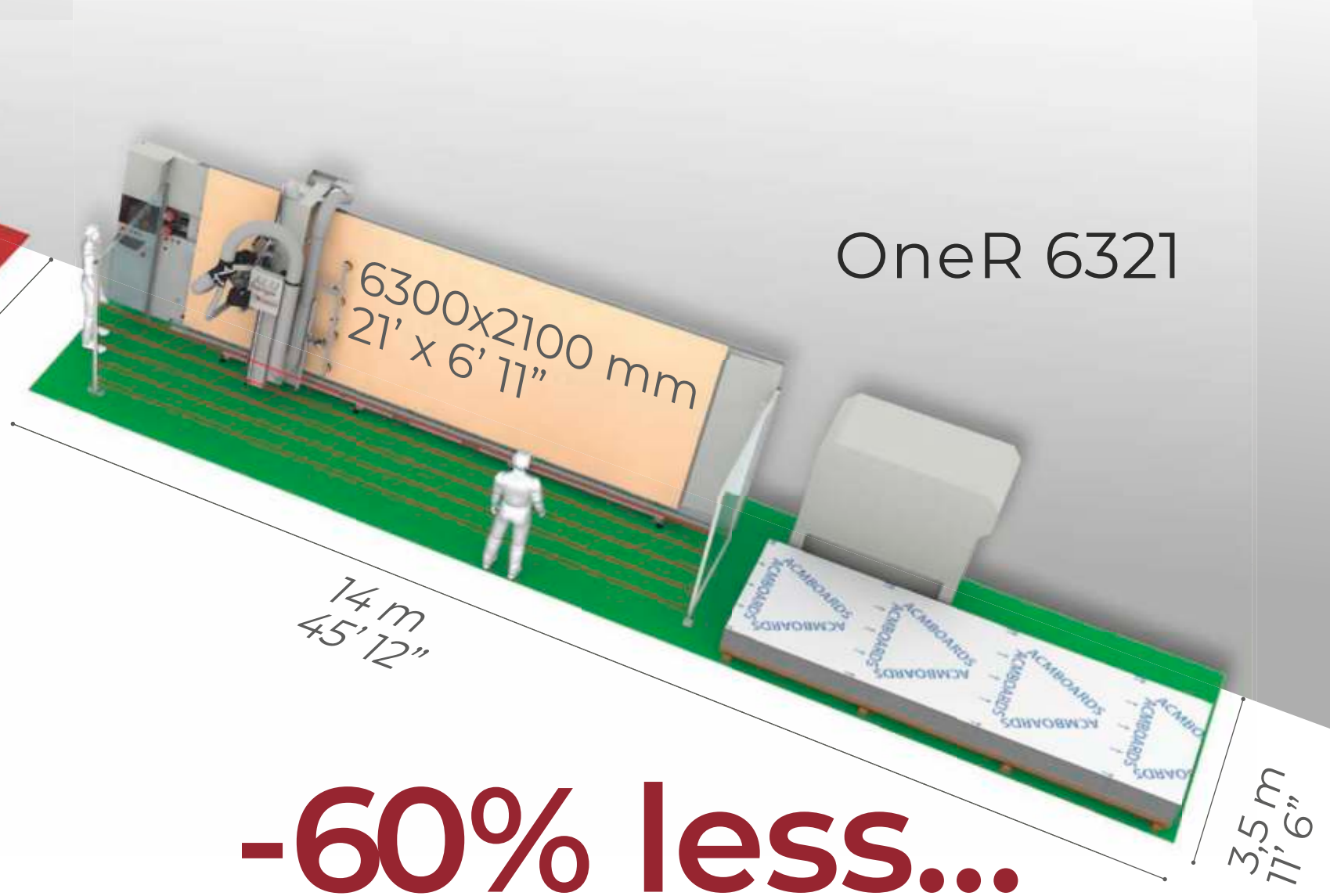
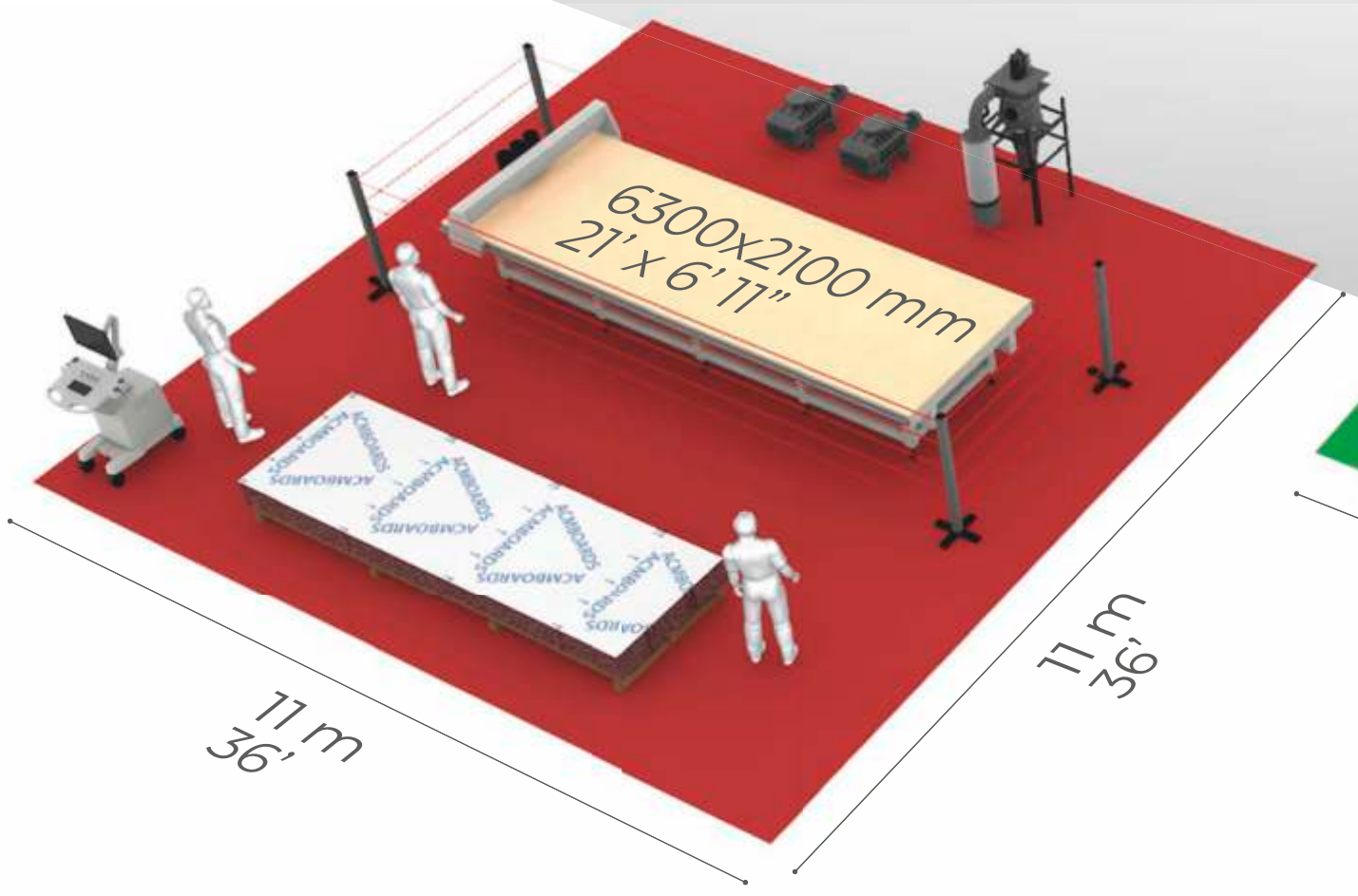

## -60% less...

- ...floor space required than a horizontal router system
- Designed to occupy less space
- Ergonomic access to the Vertical Table
- Safer work environment for the operator
- Eliminate table prep, debris not held falls to the floor

CNC PANEL ROUTER  
WITH HORIZONTAL TABLE

LAYOUT

121 sq mt - (1305 sq ft)

WORKING  
TABLE

14 sq mt - (151 sq ft)

CNC PANEL ROUTER  
WITH VERTICAL TABLE

LAYOUT

49 sq mt - (527 sq ft)

WORKING  
TABLE

14 sq mt - (151 sq ft)



# LOAD AND OFFLOAD

## ALU Ranger

**CNC Panel Router with Vertical Table**  
for architectural facades panels fabrication.

### Integrated automation

- Automatic loading and positioning without operators
- Increased productivity
- Zero risk of panels falling with patented holding device
- Ergonomically designed for easy panel off-loading

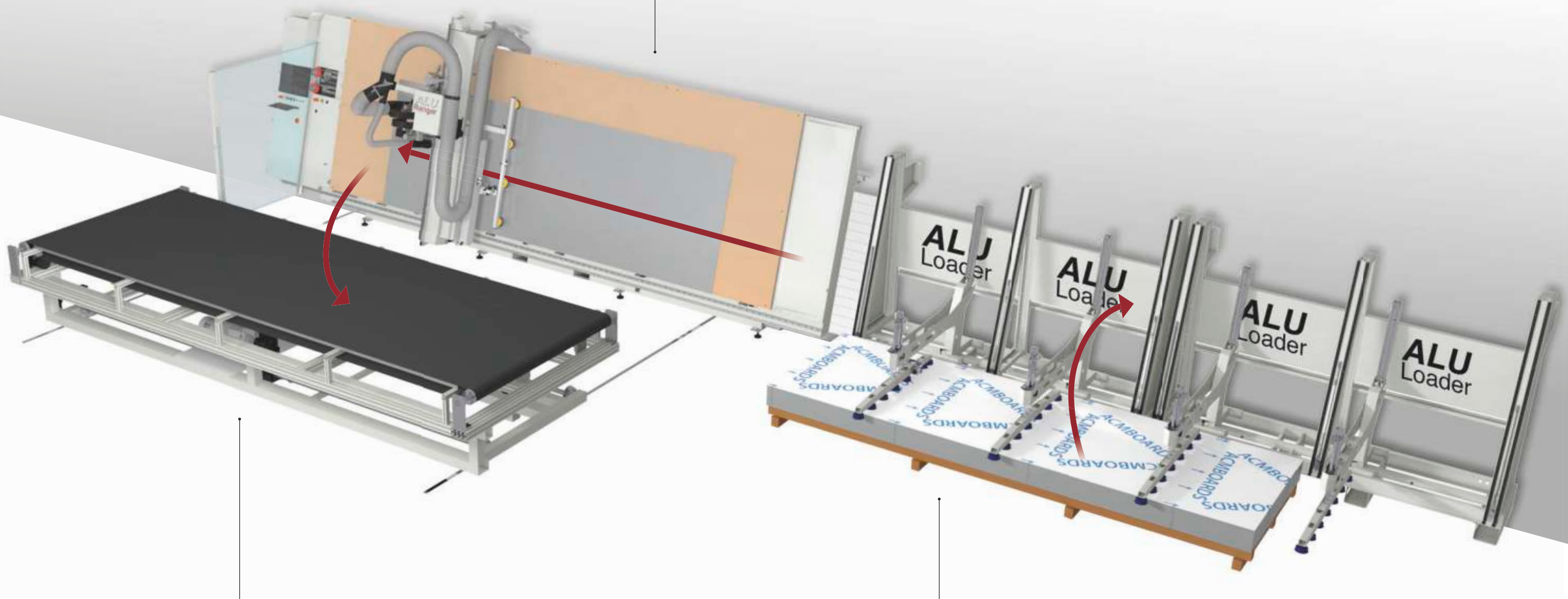

## OFF Loader

**Automatic Off Loader**  
for processed panels by a tiltable vacuum holding table. Patented.

## ALU Loader

**Loading - Positioning**  
device for architectural panels with holding arms with suction cups connected to the vacuum system of ALU Ranger. Patented.

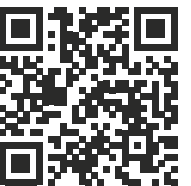



# PANEL VACUUM HOLDING

- Vacuum zones designed for standard ACM panels
- Easy Release for processed panels (patent pending)
- No risk of panels falling during off-loading
- Vacuum pumps integrated inside the machine frame: less space required and reduced noise
- Possibility of resuming work on panels that have not been unloaded without losing the references

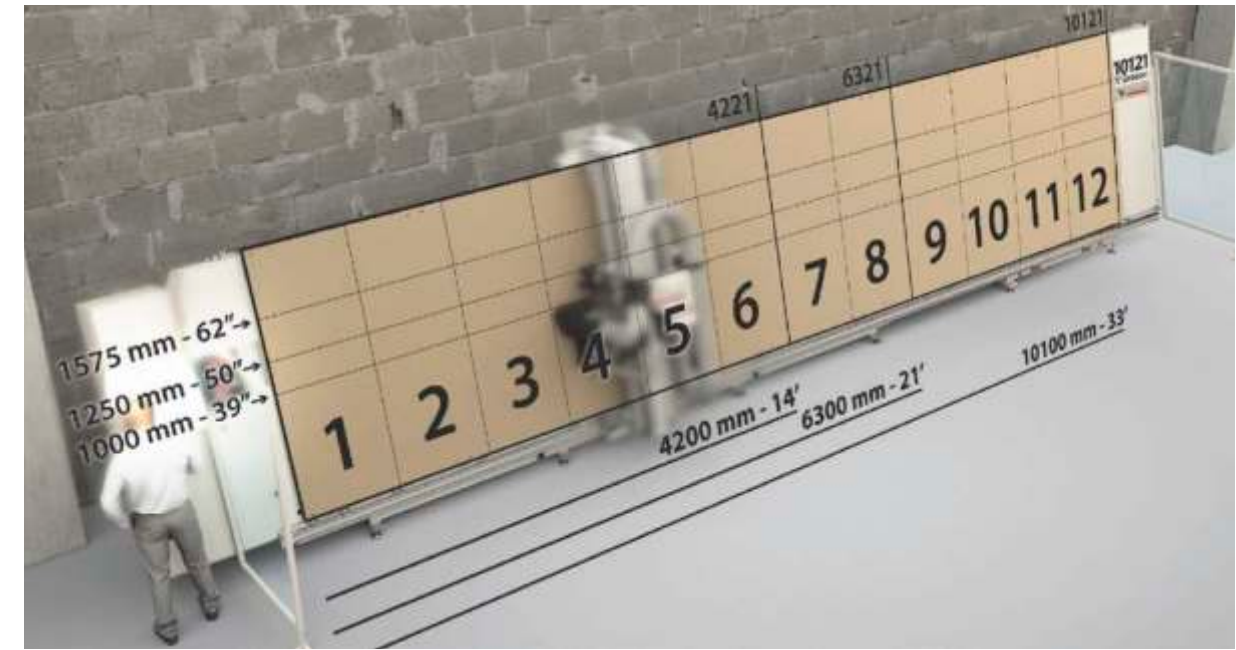

Vacuum panel holding with MDF sacrificial board.

- **Rapid selection of 24, 32** (respectively 4221, 6321) combinations of vacuum zones according to the ACM panel size (1.000–1.250–1.575 mm) (39"–50"–62")
- **Rapid selection of 24, 32** (respectively 4221, 6321) combinations of vacuum zones according to the ACM panel size (1.000–1.250–1.575 mm) (39"–50"–62")



Dry vacuum pumps (Made in Germany)

- **4221 oneR** 1x250m<sup>3</sup>/h pump Std
- **6321 oneR** 2x250m<sup>3</sup>/h pumps Std





## Material

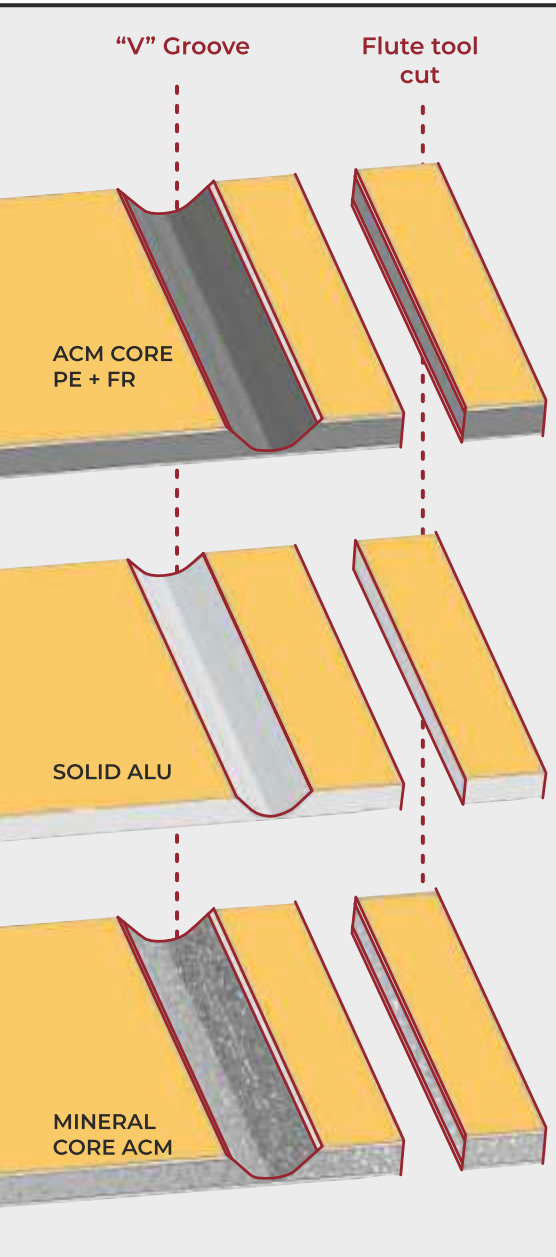

## Flute tool



Ø 4 mm  
WIDIA



Ø 6 mm  
WIDIA



Ø 10 mm  
VGROOVE  
WIDIA

WITH SUPERIOR COATING  
BY CROWN NORGE

**Processing speed\*:**  
up to ca. **16 mt/1'** - 630 IPM (PE + FR)  
up to ca. **5 mt/1'**-197 IPM (Solid Alu)



Ø 6 mm  
DIAMOND



Ø 10 mm  
VGROOVE  
DIAMOND

**Processing speed\*:**  
up to ca. **16 mt/1'** - 630 IPM  
(ACM Mineral Core)

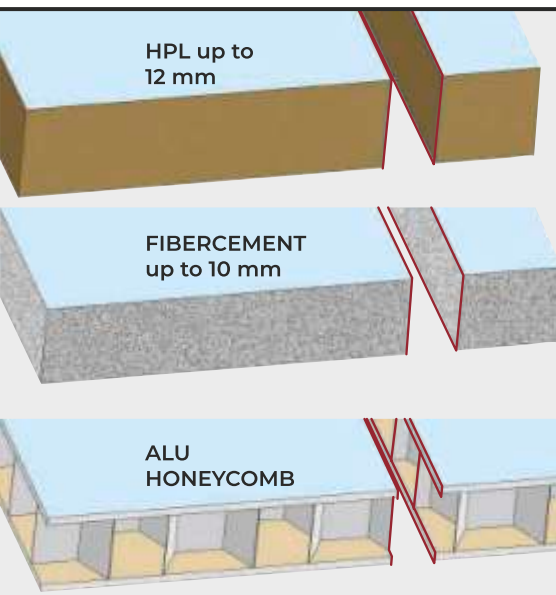

**Processing speed\*:**  
up to ca. **6 mt/1'** - 236 IPM

**Processing speed\*:**  
up to ca. **6 mt/1'** - 236 IPM

**Processing speed\*:**  
up to ca. **10 mt/1'** - 393 IPM



Ø 8 mm  
DIAMOND

IPM= INCHES PER MINUTE

# HEAD STRAIGHT

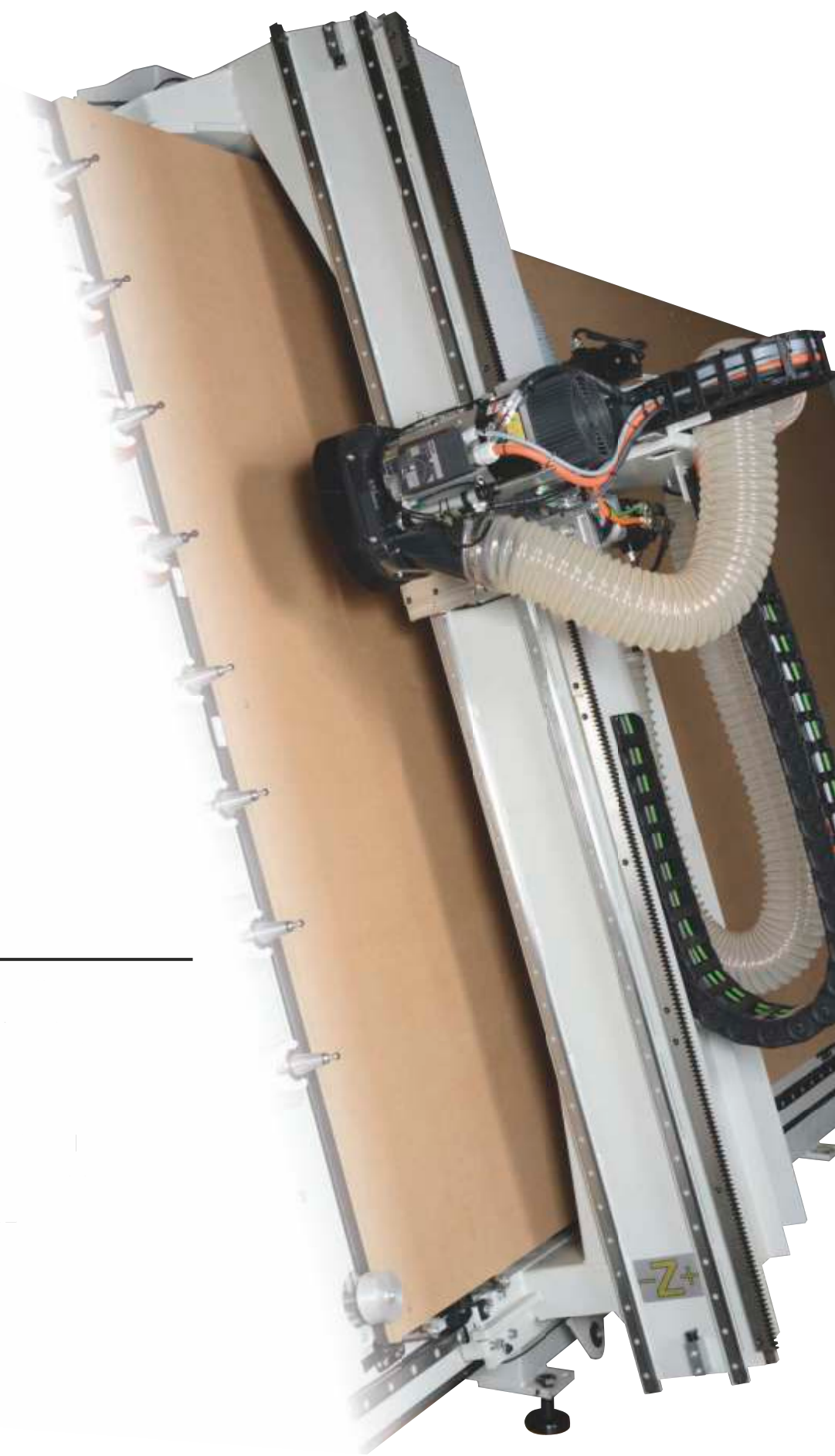

## R8A

ELECTROSPINDLE  
FOR FLUTE TOOL

- High-efficiency
- High-resistance
- Power 8 kW - up to 1500 RPM  
Electroventilated
- Integrated dust extraction
- Tool changer (flute tool)  
ISO 30 Cones - C

\* Indicative speeds for an optimal quality/duration ratio



# VERTICAL STRUCTURE



- Table flatness is guaranteed by machining the frame vertically
- The robust vertical design absorbs more vibration which results in less chatter marks during processing that will extend tool life
- Operator's safety is increased by side protection barriers and a safety light curtain

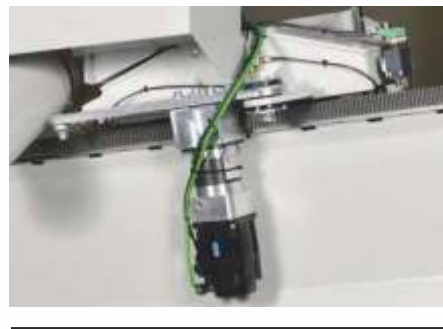

**Top gantry motor**



**Electrical cabinet and control panel integrated into the vertical frame**

- CE compliant
- Main components Made in Germany and Japan
- Perfectly accessible and free from electromagnetic disturbances

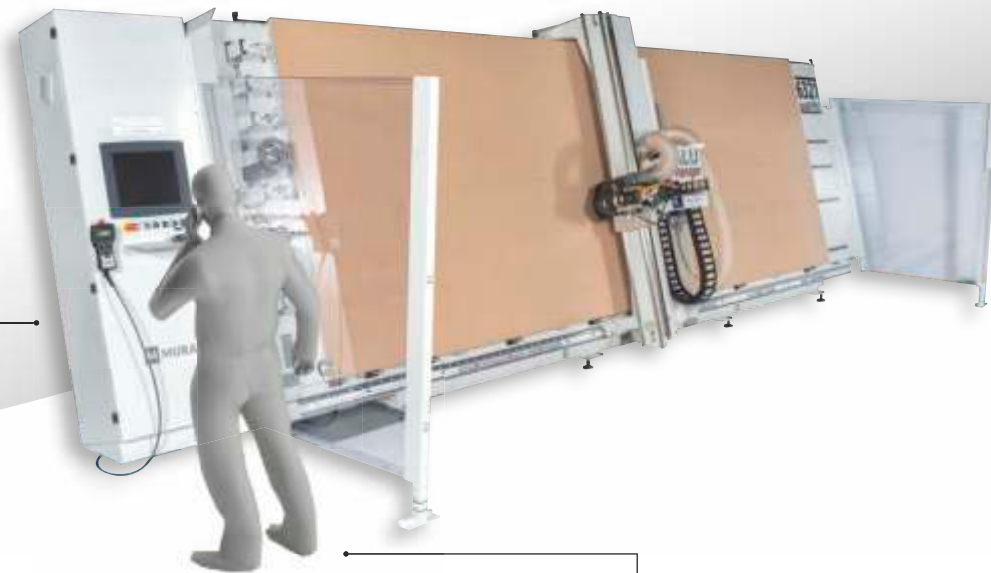

**Ergonomic access to the work table**

- Optimal control of the whole process
- Total view of the machine
- High level of safety for the operator



**Hand-held remote control (Opt)**

- 4 lines and 16 characters
- Axis manual control "JOG"
- Speed control "Override"



**Automatic presetter for tool length**

- Fully automatic
- Measurement tolerance  $\pm 0.02 \text{ mm} \pm 0.0007 \text{ In}$



**Industrial numerical control**

- Up to 7 axis controlled (X,Y,Z interpolating)
- 17" LCD colour monitor
- Ethernet connection, USB, mouse



**Origin pop-up stops**

- Bearing for easy panel sliding
- Pneumatic control with safety sensor connected to PLC



**Automatic lubrication for linear guides**



**Automatic lubrication for tools (Opt.)**

# DIMENSIONS

## Technical features

|  | ALU Ranger<br>oneR<br><b>4221</b>                      | ALU Ranger<br>oneR<br><b>6321</b>        |
|--|--|--|
| Working table (mm)   | X 4200 - Y 2100 - Z 90                                 | X 6300 - Y 2100 - Z 90                   |
| Working table (imperial)   | X 14' - Y 6' 11" - Z 3' ½                              | X 20' 8" - Y 6' 11" - Z 3' ½             |
| Panel holding, vacuum by working table with MDF sacrificial board (selection by PLC) | 6 zones AUTO   | 8 zones AUTO                             |
| Panel holding vacuum by zones combinations   | 24   | 32                                       |
| Vacuum pump  | 1 x 250 m <sup>3</sup> /h<br>1 x 147 Cfm               | 2 x 250 m <sup>3</sup> /h<br>2 x 147 Cfm |
| Axis speed (Rapid)   | X 30 - Y 30 - Z 10 mt/min<br>X 1181 - Y 1181 - 394 IPM |  |
| Electrospindle R8A   | 8 Kw - collet ER32 up to 24000 g/min                   |  |
| Automatic tool changer - working table side  | 8 positions - cones ISO30 - cone sensor                |  |
| Total power  | min 14 KW – max 24 KW                                  | min 19 KW – max 29 KW                    |
| Max weight of panel under process  | ca. 250 Kg<br>ca. 550 Lb                               | ca. 350 Kg<br>ca. 772 Lb                 |
| Total weight   | ca. 2700 Kg<br>ca. 5952 Lb                             | ca. 3600 Kg<br>ca. 7930 Lb               |

We reserve the right to make modifications. The machine can include equipment not shown in standard version.  
For photographic reasons some units are without protections. The use of machine must be made with all protections installed.

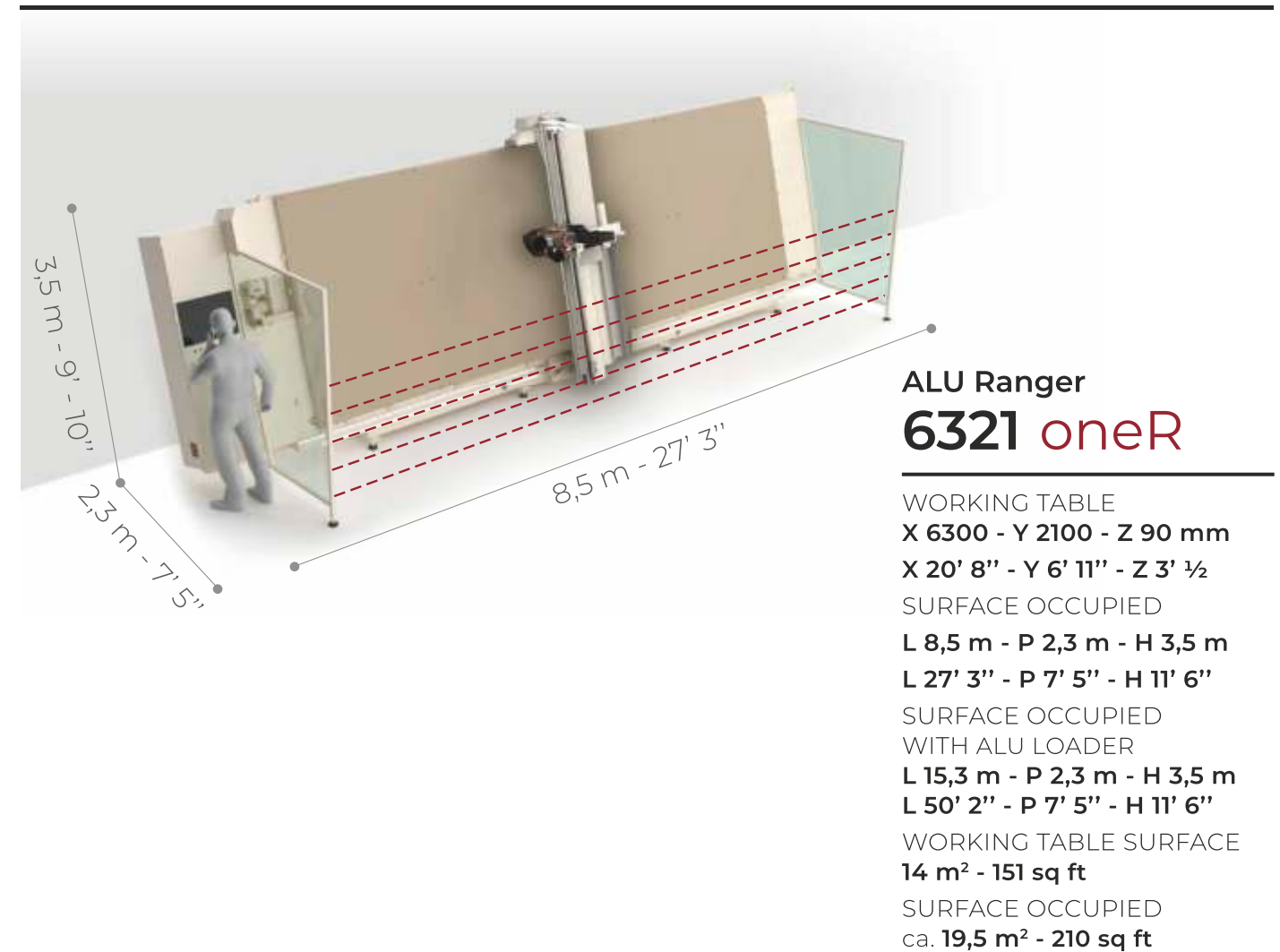
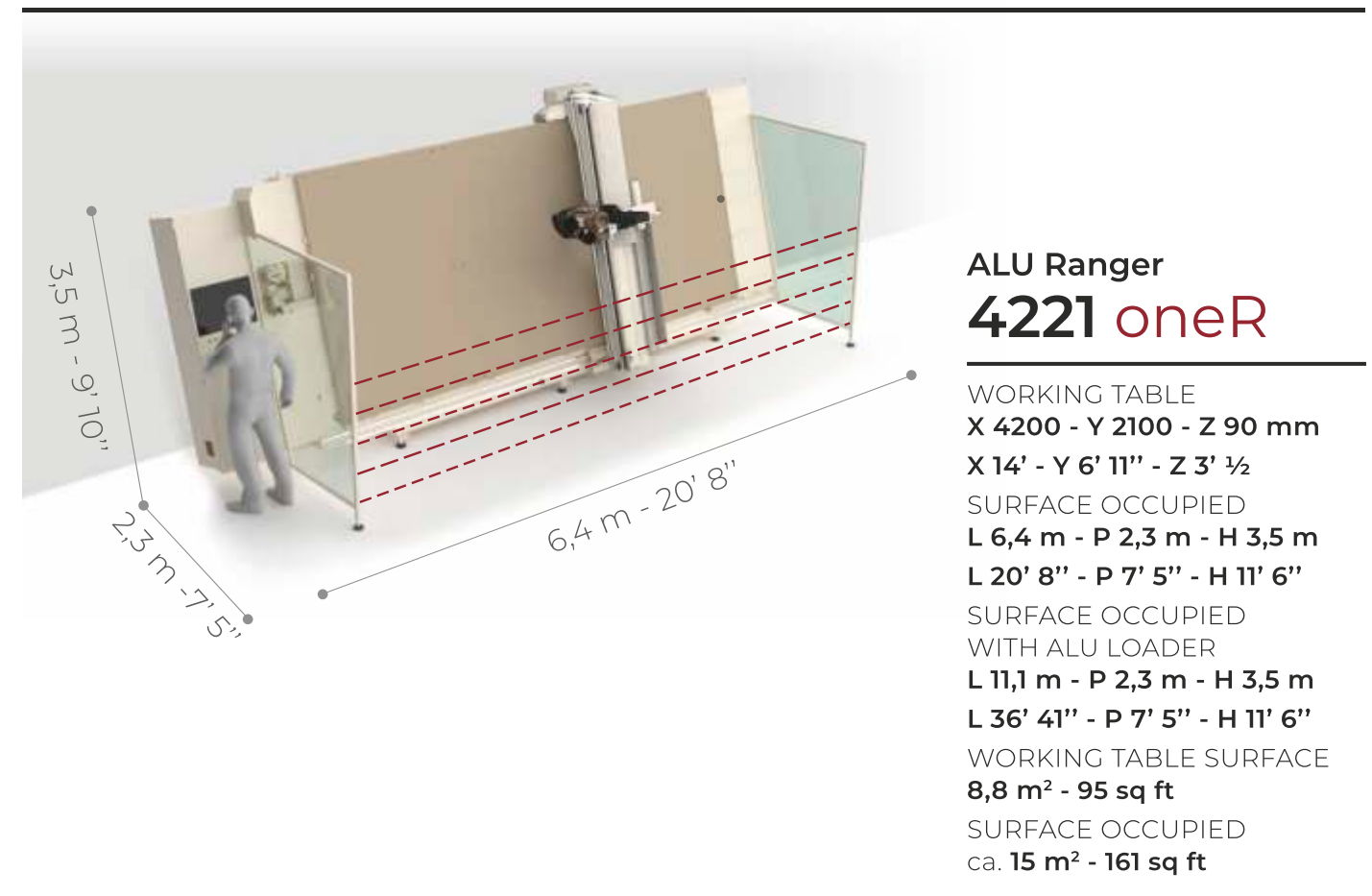



# MURATORI MACHINES



For three generations the Muratori family have been manufacturing machines for the wood processing industry, while evolving and diversifying its production to include machines for processing aluminium panels and composite materials. Suitable for architectural façade cladding, the transport industry, interior design and sign-making sectors.

**Antonio Muratori** received his training at and became an expert in the family business, where, thanks to almost three decades of experience, he has conceived, designed, and built the technology for automated handling and processing of composite panels.



## About us

Muratori Machines was established and followed in the footsteps of the tradition and know-how acquired by Casadei Industria ALU. It now has a robust industrial organisation where, under the guidance of Antonio Muratori, its technologies, machines and CNC for the processing of ACM, solid aluminium, aluminium honeycomb, HPL and fibre cement panels are designed and built. Professionalism, expertise and with an open mind making it possible to meet the needs of customers. Introducing automation to the world of composite panel processing, while responding to production requirements. Totally committed the team at Muratori Machines focuses on innovation and quality with a view to finding ground-breaking solutions and revolutionising design and manufacturing models.

## CNC machining innovation incorporating a Vertical Table

The innovation factor finds full expression in the vertical positioning of the working table. Thanks to automated panel loading, positioning and offloading systems, the integrated work cell achieves exceptional productivity levels.



## The advantages of a vertical system assure tangible results

- Reduced space requirements
- Quality assurance during processing
- Enhanced ergonomics and safety
- Single operator for process control





# VISION

*We aim to break the status quo and revolutionise traditional design and manufacturing methods, with a view to maximising ergonomics, operability, and ease of use.*

# MISSION

*We facilitate traditional production cycles for our customers. Using innovative technology within everyone's reach automating processes, involving composite material processing.*



# THANK YOU



On behalf of our employees and partners around the world, thank you for your interest in Muratori Machines.

Since the first ACM panel routed in 2006 we have one mission: to create and provide the best composite material panel handling and fabricating experience possible.

Muratori Machines have invested for the long term, consistently dedicating resources to researching and developing innovative panel routers, handling technologies and services that provide value to our customers.

This approach has culminated in our range: the Alu Ranger, Alu Loader, Double Loader, Off Loader, Alu Folder, Alu Bender, Alu Doublor.

In short, we have revolutionized the concept of panel routing and with it, the business of the panel fabricating industry.

Thank you again for your interest in exploring Muratori Machines.

We are ready to improve your business.

Sincerely,  
**Antonio Muratori**  
CEO  
**Muratori Machines**





# MURATORI

The Vertical Revolution for composite panels

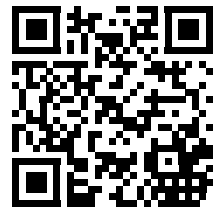

## STAMAC ENGINEERING PTY LTD

59 Naxos Way, Keysborough, Victoria 3173

Phone / Fax: +613 9769 3988

Mobile: +61451 665 316

Email: [peter@stamac.com.au](mailto:peter@stamac.com.au)

Web: [www.stamac.com.au](http://www.stamac.com.au)