



## **OWANDY-RX**

PRECISION AND SIMPLICITY

AC/DC INTRAORAL RADIOLOGY SYSTEM

# Owandy-RX

## HIGH FREQUENCY TECHNOLOGY

2 versions available:  
High frequency (DC)  
Standard (AC)

## INTUITIVE

Clearly labelled,  
with simple,  
user-friendly  
configuration

## DESIGN

Subtle, compact  
design that can  
adapt to all  
situations

## ERGONOMICS & ACCURACY

Flexible and adjustable  
arms to obtain exactly  
the right position.  
3 arm lengths  
available

## WIRELESS

Wireless option  
available with  
DC version

## MOBILE VERSION

A mobile version of the  
Owandy-RX is also  
available





## Accuracy & reliability

The new Owandy-RX intraoral radiology system is known for its accuracy and reliability.

Enjoy consistent exposure settings as well as high quality radiation!



## Ergonomic design, flexible arm

Designed to withstand the stresses of daily use. The arm is easy to adjust, flexible and robust.

Its 3 arm lengths are designed to adapt to the layout of your surgery, tailoring the unit to your workstation as effectively as possible.

Contemporary, subtle and compact, this unit blends seamlessly into your surgery's environment.



## User friendly

The Owandy-RX is very intuitive to use and requires no special staff training.

All settings are easy to configure (exposure time, patient typology, kV, mA, etc.)

The Owandy-RX works with all receiver terminals: digital sensors, imaging plates, films, etc.



## Minimal dose **affording maximum protection**

The safety of your patients is one of our key priorities!

Its High Frequency technology reduces x-rays considerably, eliminating harmful soft rays.

The DC (high frequency) version comes with the "Wireless switch" option, allowing you to control X-ray emissions remotely, and ensuring maximum safety of personnel.

The wireless option makes installation easy: no need to worry about cable entries.



### Clinical cases with phosphor imaging plates

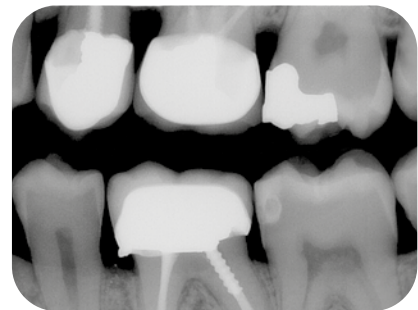
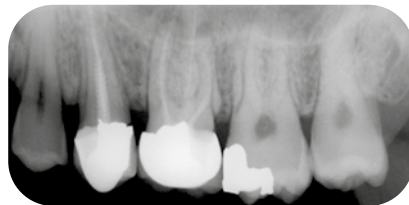
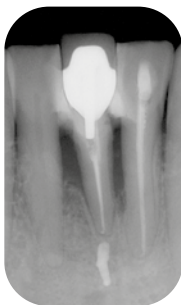

### Clinical cases with digital sensors

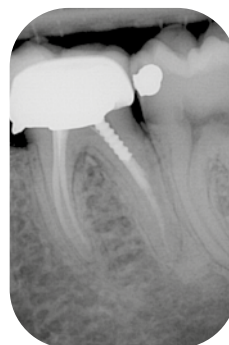
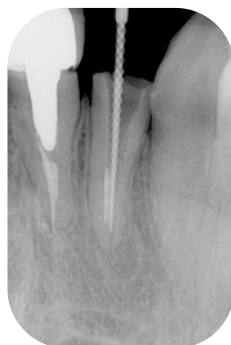
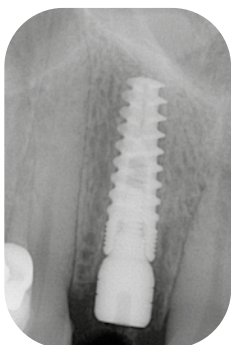



## Technical features

	OWANDY-RX AC	OWANDY-RX DC
Category	Class I, type B (CEI EN60601-1:2007)	
Supply voltage	115/220/230 V - single phase 50/60 Hz	115/230 V - single phase 50/60 Hz
Power input	0,8 kVA	1,4 kVA
High voltage	70 kV	60 à 70 kV
Anode current	8 mA	4 à 8 mA
Focus	0,7 mm	
Total filtration	Equivalent to 2 mm Al. à 70 kV	
Leakage radiation	< 0,25 mGy/h	
Technology	Alternating current	Direct current
Timer	from 0.08 to 3.2 secs	from 0.02 to 3.2 secs
Head weight	9 kg	5,5 kg
Total weight	23 kg	19,5 kg
Arm extensions	41 cm / 82,5 cm / 110 cm	
Options	Mobile version	Mobile version Wireless
Accessories	Long cone (31cm) / Long rectangular cone (31cm)	

## Technical diagrams

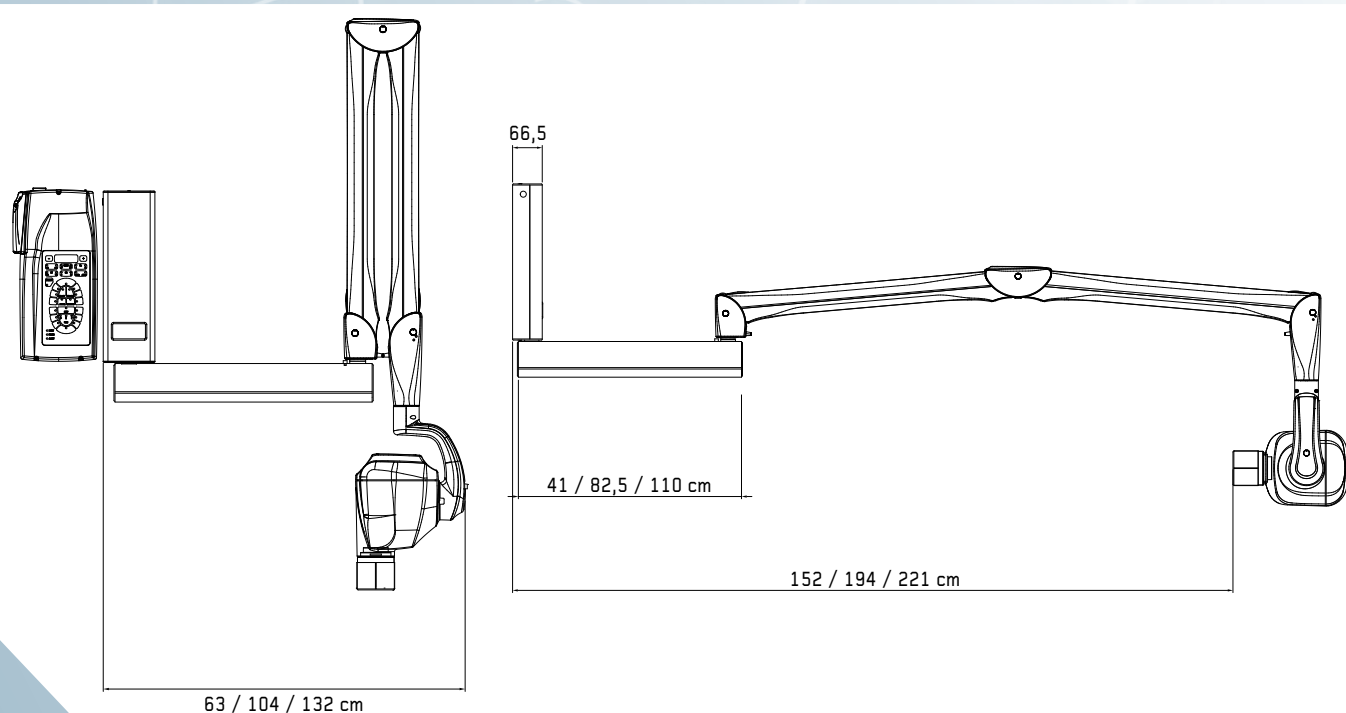



# DIGITAL WORKFLOW OWANDY RADIOLOGY

A COMPREHENSIVE RANGE TO MEET ALL YOUR REQUIREMENTS

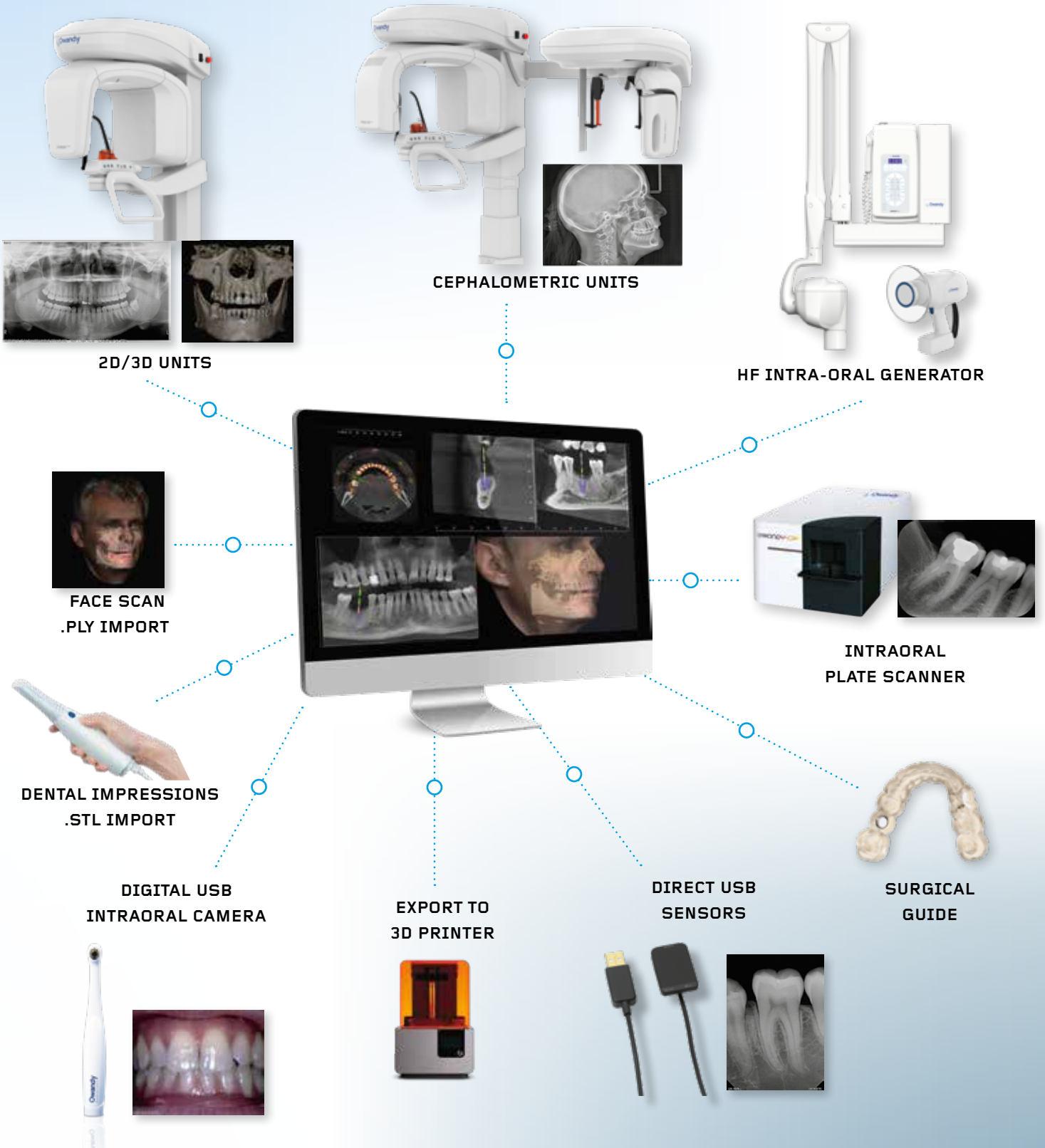

BR\_OWANDYRX-ACDC\_EN\_REV02



2, rue des Vieilles Vignes - 77183 Croissy-Beaubourg - FRANCE

Tel.: +33 1 64 11 18 18- info@owandy.com - www.owandy.com