

Convotherm maxx

just right



Combi oven

Cmx eT 6.10 ES / Cmx eT 10.10 ES

User manual - Original, ENG

Advancing Your Ambitions

Table of Contents

1	General information	5
1.1	EC Declaration of Conformity for electric combi oven	5
1.2	Environmental protection	6
1.3	Identifying your combi oven	7
1.4	Structure of customer documentation	8
1.5	About this user manual	8
1.6	Essential reading relating to safety	9
2	Design and function	10
2.1	The functions of the combi oven	10
2.2	Design and function of the combi oven	11
2.3	Layout and function of the operating panel	12
3	For your safety	13
3.1	Basic safety code	13
3.2	Intended use of your combi oven	14
3.3	Warning signs on the combi oven	15
3.4	Owner obligations	17
3.5	General hazards	18
3.6	Hazards arising from the appliance	20
3.7	Safety devices	23
3.8	Requirements to be met by personnel, working positions	25
3.9	Personal protective equipment	26
4	Cooking procedures	27
4.1	Basic principles for loading the combi oven	27
4.1.1	Positioning the food containers	27
4.1.2	Loading capacity for the combi oven	28
4.2	Operating principles and instructions for cooking	29
4.2.1	Turning the combi oven on and off	29
4.2.2	How to cook	31
4.3	Specific Cooking Instructions	33
4.3.1	Opening and closing the appliance door safely	33
4.3.2	Loading and removing food	35
4.3.3	Putting away and retrieving the core temperature probe	37
4.3.4	Using a USB stick	38
4.3.5	Inserting and removing racks	39
5	Cleaning procedures	41
5.1	Basic principles for cleaning the combi oven	41
5.1.1	Cleaning methods	41
5.1.2	Cleaning instructions	42
5.1.3	Cleaning agents	44
5.1.4	Preparing the cleaning agents	45
5.2	Operating principles and instructions for cleaning	46
5.2.1	How to perform fully automatic oven cleaning	46
5.2.2	How to clean the cooking chamber without using cleaning agents	48
5.2.3	How to perform oven cleaning using only rinse aid	50
5.2.4	How to clean the cooking chamber by hand	51
5.2.5	How to clean the interior glass panel of the triple glass door	52
5.2.6	How to clean the intermediate glass panel of the triple glass door	53

Table of Contents

5.2.7	How to clean the cooking chamber behind the suction panel	54
5.2.8	How to perform intensive cleaning of the hygienic plug-in gasket	55
5.3	Specific Cleaning Instructions	56
5.3.1	Replacing the rinse aid canister	56
5.3.2	Replacing the cleaning agent canister	59
5.3.3	Removing and fitting the suction panel	61
5.3.4	Removing and fitting the hygienic plug-in gasket	63
5.3.5	Removing and fitting the interior glass panel of the triple glass door	64
5.3.6	Removing and fitting the intermediate glass panel of the triple glass door	66
6	Servicing procedures	68
6.1	Basic principles for servicing	68
6.1.1	Contact customer service	68
6.1.2	Warranty information	69
6.1.3	Servicing schedule	70
6.2	Troubleshooting	71
6.2.1	Error codes	71
6.2.2	Emergency mode	72
6.2.3	Problems during use	74
6.3	Servicing tasks	76
6.3.1	Replacing the hygienic plug-in gasket	76

1 General information

1.1 EC Declaration of Conformity for electric combi oven

Manufacturer

Production

Welbilt (Foshan) Foodservice Co., Ltd., Chuang Ye Road, Song Gang Industrial Park, Song Gang Township, Nanhai Foshan, Guangdong 528234, China

Authorized representative

Convothem Elektrogeräte GmbH, Welbilt, Talstraße 35, 82436 Eglfing, Germany

Validity of Declaration of Conformity

This Declaration of Conformity applies to the following types of electric appliance:

- Cmx eT 6.10 ES
- Cmx eT 10.10 ES

Valid range for serial numbers

Conformity applies to the following range of serial numbers in conjunction with the part number and revision number of the combi oven:

- Serial number range from August 2020 onwards: T##2008####
- Part number and revision number: T#####F1####

Declaration of Conformity with directives and standards

The manufacturer declares that the combi oven specified above complies with the following directives and the requirements in the following European standards:

2006/42/EC (EC/CE) (Machinery Directive)

- DIN EN 60335-2-42: 2012

The safety objectives of European Directive 2014/35/EU (Low Voltage Directive) have been met in accordance with Annex I, Section 1.5.1 of the Machinery Directive.

2014/53/EU (CE) (Radio Equipment Directive)

- EN 301 489-1 V2.2.3: 2019
- EN 301 489-17 V3.1.1: 2017

The safety objective of European Directive 2014/30/EU (EMC Directive) has been met in accordance with Article 3.1b of the Radio Equipment Directive.

- EN 55014-1: 2006 + A1: 2009 + A2: 2011
- EN 55014-2: 1997 + A1: 2001 + A2: 2008
- EN 61000-3-11: 2000
- EN 61000-3-12: 2011
- EN 62233: 2008

2011/65/EU (RoHS Directive) and Directive (EU) 2015/863 amending Annex II of the RoHS Directive

- EN 63000: 2019

Authorized body for documentation

The following body is authorized to compile the technical documentation in accordance with Annex II A Section 2 of Directive 2006/42/EC: Convothem Elektrogeräte GmbH, Wellbilt, Talstraße 35, 82436 Eglfing, Germany.

Eglfing, 31.08.2020



Reine Wasner

Managing Director,
Convotherm Elektrogeräte GmbH



i.V. Gisela Rosenkranz

Manager Product Compliance and
Technical Communication,
Convotherm Elektrogeräte GmbH

Foshan, 31.08.2020



François Chatel

General Manager, Welbilt (Foshan)

1.2 Environmental protection

Statement of principles

Our customers' expectations, the legal regulations and standards and our company's own reputation set the quality and service for all our products.

We have an environmental management policy that not only ensures compliance with all environmental regulations and laws, but also commits us to continuous improvement of our green credentials.

We have developed a quality and environmental-management system in order to guarantee the continued manufacture of high-quality products, and to be sure of meeting our environmental targets.

This system satisfies the requirements of ISO 9001:2015 and ISO 14001:2015.

Environmental protection procedures

We observe the following procedures:

- Use of residue-free compostable wadding materials
- Use of RoHS-compliant products
- REACH chemical law
- Recommendation and use of bio-degradable cleaning agents
- Recycling of electronic waste
- Environmentally friendly disposal of old appliances via the manufacturer

Join us in our commitment to protect the environment.

1.3 Identifying your combi oven

Position of type plate

The type plate is located on the left-hand side of the combi oven.

Layout and structure of the type plate

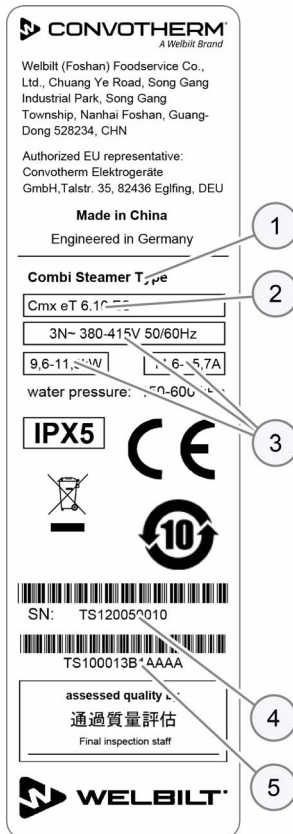

Item	Name		
1	Name of appliance Combi Oven		
2	Trade name	Element	Meaning
		Cmx	Convotherm maxx appliance series
		eT	easyTouch controls
		numbers xx.yy	Appliance size
		ES	Electric appliance with water injection
3	Electrical values	-N	for appliances with an NSK certificate
4	Serial number	Element	Meaning
		Heating method	Electric appliance (T)
		Steam generation method	<ul style="list-style-type: none"> ▪ Injection (S)
		Appliance size	<ul style="list-style-type: none"> ▪ 6.10 (1) ▪ 10.10 (3)
		Year of manufacture	<ul style="list-style-type: none"> ▪ 2020 (20) ▪ 2021 (21) ▪ ...
		Month of manufacture	<ul style="list-style-type: none"> ▪ January (01) ▪ February (02) ▪ March (03) ▪ ...
		Sequential number	4 digits
5	Part number		

1.4 Structure of customer documentation

Contents of the appliance documentation

Book type	Contents
Installation manual	<ul style="list-style-type: none">▪ Describes how to move, set up and install the appliance, and how to put the appliance into service▪ Describes the hazards and appropriate preventive measures relevant to all installation tasks▪ Contains the technical data
User manual	<ul style="list-style-type: none">▪ Describes the working procedures and operating steps for cooking and cleaning▪ Contains the servicing schedule and information on troubleshooting▪ Describes the hazards and appropriate preventive measures relevant to operation
Operating instructions	<ul style="list-style-type: none">▪ Describes the appliance user interface▪ Contains instructions on how to use the software

Documentation for accessories

Please refer to the relevant instructions for the accessory concerned (e.g. recoil hand shower, hood, stand on castors, stacking kit) for information on how to use the accessory.

1.5 About this user manual

Who should read this manual

Name of target group	Tasks
Owner of the combi oven or owner's member of staff who is responsible for the appliance and for the operating personnel	<ul style="list-style-type: none">▪ Bears the responsibility for transferring knowledge to all other users about how to work safely and correctly with the appliance during operation, cleaning and servicing.▪ Is responsible for ensuring that the appliance is in an operational state prior to use. See 'Owner obligations' on page 17 for details
Chef	Essentially performs organizational tasks such as <ul style="list-style-type: none">▪ Entering the cooking profile data▪ Editing existing cooking profiles in the cookbook▪ Developing new cooking profiles▪ Adjusting appliance settings May also perform all user tasks if applicable.
User	Essentially performs specific operating tasks such as <ul style="list-style-type: none">▪ Loading the combi oven▪ Starting cooking profiles▪ Removing food▪ Cleaning the combi oven▪ Minor servicing tasks

Notation for decimal points

A decimal point is always used in order to achieve international standardization.

1.6 Essential reading relating to safety

Safety information in the customer documentation

Safety information relating to the combi oven appears only in the installation manual and the user manual.

The installation manual contains the safety information for the tasks covered by the manual and which are performed when moving, setting up and installing the appliance and when putting the appliance into service and removing the appliance from service.

The user manual contains the safety information for the tasks covered by the manual and which are performed during cooking, cleaning and servicing work.

The safety information contained in the user manual and installation manual must always be considered to be part of the operating instructions. The safety information contained in the user manual and installation manual must always be observed when performing tasks that go beyond merely operating the software.

Parts of this document that must be read without fail

If you do not follow the information in this document, you risk potentially fatal injury and property damage.

To guarantee safety, all people who work with the combi oven must have read and understood the following parts of this document before starting any work:

- the chapter 'For your safety' on page 13
- the sections that describe the activity to be carried out

Danger symbol



Danger symbol	Meaning
---------------	---------



Warns of potential injuries. Heed all the warning notices that appear after this symbol to avoid potential injuries or death.

Form of warning notices

The warning signs are categorized according to the following hazard levels:

Hazard level	Consequences	Likelihood
 DANGER	Death / serious injury (irreversible)	Immediate risk
 WARNING	Death / serious injury (irreversible)	Potential risk
 CAUTION	Minor injury (reversible)	Potential risk
NOTICE	Damage to property	Potential risk

2 Design and function

2.1 The functions of the combi oven

The cooking modes

You can cook a range of food in your combi oven. The combi oven is able to do this by working in the following cooking modes:

- Steam
- Combi-steam
- Convection

Standard cooking methods

You can use the Custom cooking operating mode in conjunction with the extra functions HumidityPro, Crisp&Tasty, fan speed and BakePro to perform the following cooking methods for instance:

- | | | |
|--------------|------------|--------------|
| ▪ Boiling | ▪ Steaming | ▪ Stew |
| ▪ Blanching | ▪ Poaching | ▪ Braising |
| ▪ Roasting | ▪ Grilling | ▪ Baking |
| ▪ Scalloping | ▪ Gratinat | ▪ Defrosting |
| ▪ Preserving | | |

Cooking profiles and cookbook

A cooking profile is a combination of cooking parameters such as cooking temperature and cooking time. You can create your own cooking profiles and manage them in the 'Cookbook'. You can also find ready-made cooking profiles in the 'Cookbook'.

Oven cleaning

The following options are available for cleaning the cooking chamber:

- ConvoClean fully automatic oven cleaning:
 - Oven cleaning without using cleaning agents; rinsing with water
 - Express cleaning
 - Oven cleaning for light soiling
 - Oven cleaning for heavy soiling
 - Oven cleaning using only ConvoCare rinse aid

2.2 Design and function of the combi oven

Components and function

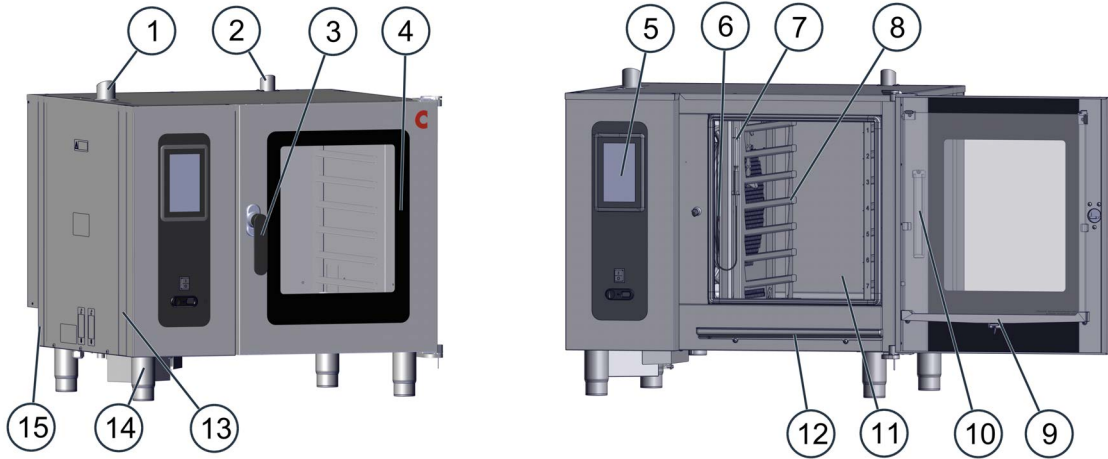

Item	Name	Function
1	Ventilation port	<ul style="list-style-type: none"> External air intake for removing the moisture from the cooking chamber Smooths out any pressure fluctuations in the cooking chamber
2	Air vent	Allows hot vapour to escape
3	Door handle	<ul style="list-style-type: none"> Opens and closes the appliance door First latch position after 5° Sure-shut function Antibacterial ("HygienicCare")
4	Appliance door	Closes the cooking chamber
5	Operating panel	Used for operating the appliance
6	Suction panel	<ul style="list-style-type: none"> Distributes the heat evenly inside the cooking chamber Separates the fan compartment from the cooking chamber Protects against touching the fan
7	Core temperature probe (optional)	Measures the core temperature of the food being cooked
8	Rack	Holds standard-sized food containers
9	Door drip tray	Collects condensate running down the inside of the appliance door
10	Oven light (LED)	Illuminates the cooking chamber
11	Cooking chamber	Contains the food during cooking operation
12	Appliance drip tray	Collects dripping liquid and condensate from the cooking chamber
13	Type plate	Identifies the appliance
14	Appliance feet	Can be adjusted in height to allow the appliance to be positioned horizontally
15	Network port (rear)	For connecting to the Internet

2.3 Layout and function of the operating panel

Layout and elements of the operating panel

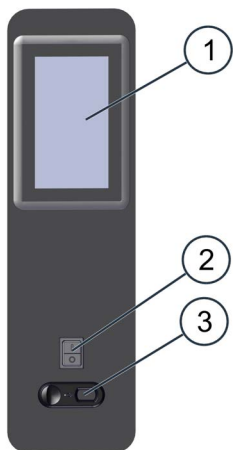

Item	Name	Function
1	Full touch screen display	Central controls for appliance <ul style="list-style-type: none">▪ Appliance operated by touching icons on the control panel (full touch screen display)▪ Status displays
2	Appliance ON/OFF switch	Switches the combi oven on and off
3	USB port	For connecting a USB stick

3 For your safety

Purpose of this chapter

This chapter provides you with all the information you need in order to use the combi oven safely without putting yourself or others at risk.

This is a particularly important chapter that you should read through carefully.

3.1 Basic safety code

Object of this safety code

This safety code aims to ensure that all persons who use the combi oven have a thorough knowledge of the hazards and safety precautions, and that they follow the warning notices given in the user manual and on the combi oven. If you do not follow this safety code, you risk potentially fatal injury and property damage.

Referring to the user manuals included in the customer documentation

Follow the instructions below:

- Read in full the chapter 'For Your Safety' and the chapters that relate to your work.
- Always keep to hand the manuals included in the customer documentation for reference.
- Pass on the user manuals included in the customer documentation with the combi oven if it changes ownership.

Working with the combi oven

Follow the instructions below:

- Only those persons who satisfy the requirements stipulated in this user manual are permitted to use the combi oven.
- Only use the combi oven for the specified use. Never, under any circumstances, use the combi oven for other purposes that may suggest themselves.
- Take all the safety precautions specified in this user manual and on the combi oven. In particular, use the prescribed personal protective equipment.
- Only stand in the working positions specified.
- Do not make any changes to the combi oven, e. g. removing parts or fitting unapproved parts. In particular, you must not disable any safety devices.

More on this ...

Related topics

▷ Intended use of your combi oven	14
▷ Warning signs on the combi oven	15
▷ Owner obligations	17
▷ General hazards	18
▷ Hazards arising from the appliance	20
▷ Safety devices	23
▷ Requirements to be met by personnel, working positions	25
▷ Personal protective equipment	26

3.2 Intended use of your combi oven

Intended use

- The combi oven is designed and built solely for cooking different foodstuffs in standard-sized food containers (e.g. Gastronorm containers, standard baking trays). Steam, convection and combi-steam (non-pressurized superheated steam) are used for this purpose.
- The food containers can be made of stainless steel, ceramic, plastic, aluminium, enamelled steel or glass. Glass food containers must not exhibit any form of damage.
- The combi oven is intended solely for professional, commercial use.

Restrictions on use

Some materials are not allowed to be heated in the combi oven:

- NO dry powder or granulated material
- NO highly flammable objects with a flash point below 270 °C, such as highly flammable oils, fats, plastics, cleaning products or alcohol-based fluids
- NO food in sealed tins or jars

Requirements to be met by operating personnel

- The combi oven must only be operated by personnel who satisfy specific requirements. Please refer to 'Requirements to be met by personnel, working positions' on page 25 for the training and qualifications requirements.
- Personnel must be aware of the risks and regulations associated with handling heavy loads.

Requirements relating to the operating condition of the combi oven

- The combi oven must only be operated when all safety devices and protective equipment are fitted, in working order and fixed properly in place.
- The manufacturer regulations for operating and servicing the combi oven must be observed.
- The combi oven must not be loaded over the maximum permissible loading weight for the given model; see 'Loading capacity for the combi oven' on page 28.

Requirements relating to the operating environment of the combi oven

Specified operating environment for the combi oven

- The ambient temperature lies between +4 °C and +35 °C
- NOT a toxic or potentially explosive atmosphere
- A hygienic environment
- A dry kitchen floor to reduce the risk of accidents

Specified properties of the installation location

- NO fire alarm, NO sprinkler system directly above the appliance
- NO flammable materials, gases or liquids above, on, beneath or in the vicinity of the appliance

Mandatory restrictions on use

- Shelter from rain and wind must be provided if operated outdoors
- Appliance must NOT be shifted or moved during use

Cleaning requirements

- Use only cleaning agents that have been approved by the manufacturer.
- Use only materials specified by the manufacturer for cleaning; please refer to the 'Cleaning instructions' on page 42.
- High-pressure cleaners must NOT be used for cleaning.
- Water spray or jets must NOT be used for cleaning the exterior. Use of an external water spray is permitted solely for cleaning the cooking chamber.
- The combi oven must NOT be treated with acids or exposed to acid fumes, except for the purpose of descaling the cooking chamber by an authorized service company in accordance with the manufacturer's instructions.

3.3 Warning signs on the combi oven

Fixed platform



A fixed platform for the combi oven is a permanently fixed worktable, a permanently fixed stand or a permanently fixed stacking kit. These platforms are not intended to be mobile and so are not equipped with features that would help to move them.



Positioning of warning signs



Obligatory warning signs

The following warning signs must be attached to the combi oven and optional accessories in the area indicated so as to be easily visible at all times.

Range	Warning sign	Description
1		High voltage / electric shock hazard warning There is a risk of electric shock from live parts if the safety cover is opened.
2		Hot steam and vapour hazard warning There is a risk of scalding from hot steam and vapour escaping when the appliance door is opened.

Range	Warning sign	Description
2		<p>Warning of hot food, hot food containers and hot liquids</p> <p>There is a risk of burns from hot food and hot food containers if food containers tip out of the shelf levels or food slips off food containers that are not held level. This risk is particularly high for shelf levels that lie above the sightline of the user.</p> <p>Spillage of hot liquid foods can result in scalds if the upper shelf levels are loaded with liquids or foods that produce liquid during cooking. Do not use shelf levels that lie above your sightline for liquid foodstuffs or food that will liquefy during cooking.</p>
2		<p>Warning of corrosive cleaning agents injected into oven</p> <p>There is a risk of chemical burns or irritation to skin, eyes and respiratory system from contact with sprayed cleaning agents and their vapours if the appliance door is opened during fully automatic cleaning (ConvoClean system).</p>

3.4 Owner obligations

Owner obligations in summary

The owner bears the responsibility for transferring knowledge to all other users about how to work safely and correctly with the appliance during operation, cleaning and servicing. The owner is responsible for ensuring that the appliance is in an operational state prior to use.

These obligations include the following actions

- Training of all users in all safety-related functions and devices of the combi oven
- Providing all users with suitable guidance and instruction for the work they perform with the appliance
- Gathering reports from all users on problems and irregularities relating to the appliance and its use, and carrying out, or giving instructions on, relevant corrective measures.
- Observing all necessary servicing cycles for the appliance or appliance components

Personnel for working at the combi oven

The owner must ensure that operating or cleaning tasks on the combi oven are performed solely by qualified personnel as specified in 'Requirements to be met by personnel, working positions' on page 25.

Staff training

The owner must train and instruct his staff with regard to the following points:

- Dealing with the hazards that generally exist in the kitchen environment in accordance with national regulations and requirements; please refer to 'General hazards' on page 18
- Working with the safety devices; see 'Safety devices' on page 23
- Using personal protective equipment; see 'Personal protective equipment' on page 26
- Hygiene requirements, respecting national regulations and requirements
- Dealing with the hazards arising specifically from this combi oven; see 'Hazards arising from the combi oven' on page 20

Your safety and the safety of your staff

Before your personnel start working with the combi oven for the first time, familiarize yourself as the owner with the information contained in the chapter 'For your safety' (this chapter) and make relevant safety arrangements.

Instruct your personnel to familiarize themselves with the hazard warnings listed in this chapter and in further instructions below, and instil in them the importance of taking the specified precautions.

Instruct your personnel to learn the safe-working rules and requirements given in the following instructions before they start work, and to follow them strictly.

Personal protective equipment for your personnel

Instruct your personnel to wear the correct personal protective equipment specified in the section 'Personal protective equipment' on page 26 of the 'For your safety' chapter for the relevant tasks.

3.5 General hazards

General rules for working in the kitchen

In general a huge range of hazards can arise in the kitchen. You must therefore wear the prescribed protective clothing in the kitchen, and in particular wear protective gloves when working with the kitchen appliances.

The following section describes the nature of these hazards, what effect they have and how you can avoid them.

Spraying into hot fat

In the kitchen, water spray and splashing, for instance when using a water jet or spray, can cause the following hazards:



Projectile-like dispersal of fat-and-water mixture

When?

- If water is sprayed into containers holding hot fat, causing the water to vaporize rapidly

How can I avoid the hazard?

- ▷ Wear specified protective clothing, in particular protective gloves
- ▷ Do not spray into hot fat

Spraying water onto hot surfaces

In the kitchen, water spray and splashing, for instance when using a water jet or spray, can cause the following hazards:



Risk of scalding from splashing water

When?

- If water is sprayed onto hot surfaces, e.g. into a cooking chamber

How can I avoid the hazard?

- ▷ Do not spray onto hot surfaces
- ▷ Wear specified protective clothing, in particular protective gloves

Damp kitchen floor

In the kitchen, condensate running out during cooking, for instance, can cause the following hazards:



Risk of slipping on damp kitchen floor

Where?

- In front of the appliances

How can I avoid the hazard?

- ▷ Ensure that the floor around the appliance is dry at all times

Contact with cleaning agents

Cleaning products are used in the kitchen. This can cause the following hazards:



Risk of chemical burns or irritation to skin, eyes and respiratory system from contact with cleaning agents and their vapours.

When?

- For all cleaning actions
- When handling cleaning-fluid canisters
- When abrasive cleaning products are used

How can I avoid the hazard?

- ▷ Wear personal protective equipment
- ▷ Do not let cleaning agents come into contact with your skin or eyes
- ▷ Do not breathe in spray
- ▷ Always use the specified cleaning products

Moving heavy loads

In the kitchen, lifting heavy weights can result in tiredness, discomfort and problems with the moving equipment.



Risk of injury from overstressing your body

When?

- When lifting heavy containers and other heavy loads

How can I avoid the hazard?

- ▷ Observe the rules associated with handling heavy loads

3.6 Hazards arising from the appliance

General rules for working with the appliance

The combi oven is designed to protect the user from all hazards that can reasonably be avoided by design measures.

The actual purpose of the combi oven, however, means that there are still residual risks; you must therefore take precautions to avoid them. A safety device can provide you with a certain degree of protection against some of these hazards. You must always ensure, however, that these safety devices are in place and in working order.

The nature of these residual risks and what effect they have are described below.

Hazard points

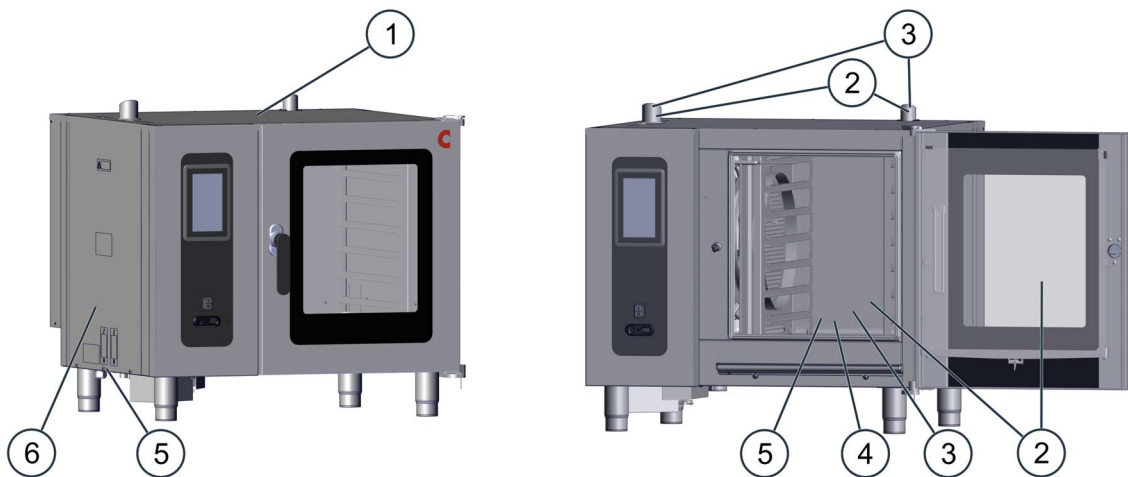

Item	Safety hazard	Hazard locations
1	Proximity to flammable materials	On top of the appliance
2	Hot surfaces	Air vent, ventilation port, appliance door and cooking chamber
3	Hot steam / vapour	Air vent, ventilation port, cooking chamber
4	Hot liquids	Cooking chamber
5	Contact with cleaning agents	Cooking chamber, cleaning-fluid connection
6	Spraying down the appliance with water	Appliance case (cover for electrical parts)
7	Break in the cold chain	(no picture)

Proximity to flammable materials

Heat produced in the appliance during cooking operations can cause the following hazards:



Fire hazard from heat given off by the appliance

What can cause this?

- By storing flammable materials, gases or liquids on top of the appliances

How can I avoid the hazard?

- ▷ Do not store flammable materials, gases or liquids on top of the appliance
- ▷ Do not store gas canisters immediately beside the appliance

Hot surfaces

During and after the cooking operation, heat produced by the appliance can cause the following hazards:



A risk of burns from hot surfaces

Where?

- Externally on the appliance door
- On the top of the appliance, in particular on the air vent and on the ventilation port
- Internally on the appliance door
- Inside the entire cooking chamber, including all parts that are or were inside during cooking mode

How can I avoid the hazard?

- ▷ Do not touch surfaces for any length of time
- ▷ Wear specified protective clothing, in particular protective gloves

Hot liquids

When loading the appliance with food that involves hot liquids, the following hazards can arise:



Risk of scalding from hot liquids

When?

- When taking hot, liquid food out of the cooking chamber

How can I avoid the hazard?

- ▷ Make sure that the racks are fixed in place properly.
- ▷ Do not exceed the maximum loading weight
- ▷ Only use containers with suitable GN dimensions
- ▷ Only load containers holding liquid or liquefying food into shelf levels that allow a proper view inside the container, and always hold horizontally when removing
- ▷ Insert the food containers correctly as stipulated in 'Positioning the food containers' on page 27
- ▷ To prevent spillage of hot liquid, place a cover on food containers after removing from the appliance and before moving them further.
- ▷ Wear specified protective clothing, in particular protective gloves

Hot steam / vapour

Operating the appliance door can result in the following hazards:



Risk of scalding from hot steam/vapour

Where? When?

- On the air vent and on the ventilation port on top of the appliance
- When opening the appliance door during and after cooking

How can I avoid the hazard?

- ▷ Do not get close to the air vent or ventilation port
- ▷ Always open the appliance door slowly and carefully
- ▷ Use the latch position of the appliance door
- ▷ When cooling takes place during the cooking or cleaning operation, expect to face a stronger blast of steam than usual, and make sure any bystanders step back from the appliance.
- ▷ Wear specified protective clothing, in particular protective gloves

Contact with cleaning agents

The following hazards can arise during cleaning of the appliance:



Risk of chemical burns or irritation to skin, eyes and respiratory system from contact with cleaning agents and their vapours.

What can cause this?

- If the cooking chamber has not been cooled sufficiently
- If the appliance door is opened during the fully automatic cleaning process
- When cleaning-fluid canisters are replaced

How can I avoid the hazard?

- ▷ Let the cooking chamber cool to below 60 °C before any cleaning tasks
- ▷ Do not open the appliance door until prompted by the software
- ▷ After cleaning has finished, visually check that all cleaning product residues have been removed by thorough rinsing.
- ▷ Exercise caution when handling the cleaning-fluid canisters

Break in the cold chain

A break in the cold chain can cause the following hazards if food is eaten:



Risk from microbiological contamination of food

When?

- When cooking is manually interrupted
- When the food cold-chain is broken by loading the cooking chamber in advance
- When cooking is interrupted because of a power failure

How can I avoid the hazard?

- ▷ Make sure that the cold chain is not broken
- ▷ Never deliberately interrupt the cooking process
- ▷ Do not store food temporarily in the appliance
- ▷ Do not place cold food in the oven when cooking at low temperatures
- ▷ Once the appliance is running again, consider how the length of time taken to resume operation will affect the food condition.

Spraying down the appliance with water

Cleaning tasks performed on the appliance can cause the following hazards:



Risk of electric shock caused by a short-circuit

When?

- If the appliance comes into contact with water

How can I avoid the hazard?

- ▷ Do not wash down the outer case with water
- ▷ Disconnect the appliance from the power supply when cleaning the outside of the appliance

3.7 Safety devices

Meaning

The combi oven has a number of safety devices to protect the user from hazards. It is absolutely essential that all safety devices are fitted, secured correctly and in working order when operating the combi oven.

Position and function

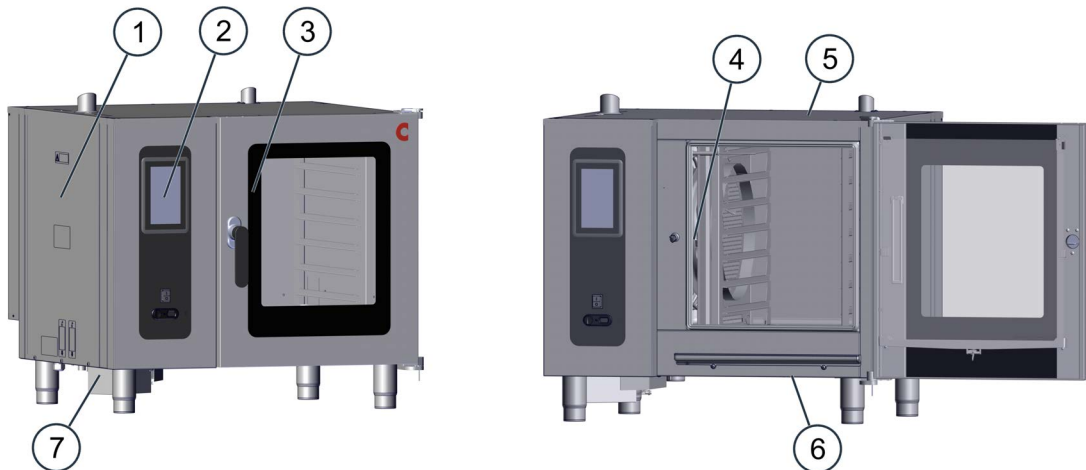

Item	Safety device	Function	Check
1	Cover can only be removed using tool	Prevents live parts from being touched accidentally	Check that the cover is in place
2	Always use a tool to open the control panel	Prevents live parts from being touched accidentally	Ensure that the operating panel is in place
3	Appliance door with magnetic door switch and latch position	<p>Appliance door: Protects the user and outside environment from hot steam</p> <p>Magnetic door switch (electrical door sensor):</p> <ul style="list-style-type: none"> ▪ When the appliance door is opened, the switch stops: <ul style="list-style-type: none"> ▪ rotation of the fan wheel (comes to a stop after a few seconds) ▪ operation of the heating element ▪ Distribution of the cleaning products by the fully automatic oven cleaning system ▪ Prompt to close the appliance door <p>Latch position at opening angle of 5°: Prevents scalding of user's face and hands from escaping steam</p>	<p>Check the door pane regularly for scratches, cracks, indentations etc. and replace it if any are found</p> <p>Check magnetic door switch at low temperature</p> <p>Action:</p> <ul style="list-style-type: none"> ▪ Open the appliance door fully ▪ Press Start <p>Result: Motor must not start up.</p> <p>When appliance is cool, check door positions as described in 'Opening and closing the appliance door safely' on page 33</p>
4	Suction panel in cooking chamber; can only be removed using a tool	Prevents access to the moving fan and ensures good heat distribution	Please refer to 'Removing and fitting the suction panel' on page 61

Item	Safety device	Function	Check
5	Cover can only be removed using tool	Prevents live parts from being touched accidentally	Check that the cover is in place
6	Cover can only be removed using tool	Prevents live parts from being touched accidentally	Check that the cover is in place
7	Circulation pump cover	Prevents access to the moving pump wheel	Check that the cover is in place
8 (no picture)	Safety thermostat in the cooking chamber	Switches off the appliance if temperature too high	An error code is output in the event of a fault (Please contact an authorized service company to reset the safety thermostat)
9 (no picture)	Restart after power failure in case cleaning agent was left in the appliance	Restarts fully automatic oven cleaning in a defined state after power failure	None
10 (installed by customer)	Disconnecter	<ul style="list-style-type: none"> ▪ Installed by the customer close to the appliance; easily visible and accessible, all-pole action, minimum contact separation 3 mm. ▪ Used to disconnect the appliance from the power supply during cleaning, repair and servicing work and in a hazardous situation 	Action: <ul style="list-style-type: none"> ▪ Trip the disconnecter ▪ Make sure that there is no live voltage at the mains supply connecting terminals

3.8 Requirements to be met by personnel, working positions

Requirements to be met by operating personnel

The table shows the skills required to perform the specified roles. One person may perform more than one role depending on need and organization of work, provided this person has the skills required for the role concerned.

Role	Skills required	Tasks
Chef Store manager Person in authority in the kitchen environment	<ul style="list-style-type: none"> ▪ Has relevant professional training ▪ Knows relevant national food legislation and regulations, plus hygiene legislation and regulations ▪ Must keep records in accordance with HACCP ▪ Trained in how to operate the combi oven 	<p>The owner's member of staff who is responsible and personally fulfils the owner obligations (see 'Owner obligations' on page 17)</p> <p>Essentially performs organizational tasks such as</p> <ul style="list-style-type: none"> ▪ Entering the cooking profile data ▪ Editing existing cooking profiles in the cookbook ▪ Developing new cooking profiles ▪ Adjusting appliance settings <p>May also perform all user actions if applicable</p>
User	<ul style="list-style-type: none"> ▪ Semi-skilled ▪ Trained in how to operate the combi oven ▪ Works under supervision ▪ Knows the regulations associated with handling heavy loads 	<p>Essentially performs specific operating tasks such as</p> <ul style="list-style-type: none"> ▪ Loading the combi oven ▪ Starting the cooking profile ▪ Removing food ▪ Cleaning the combi oven ▪ Fitting accessories where needed for specific cooking operations ▪ Minor servicing tasks

Working positions during operation

The working position for personnel when operating the combi oven is in front of the appliance door.

Working positions during cleaning and servicing

The working position for staff during cleaning and servicing is the entire appliance area.

3.9 Personal protective equipment

Operation and servicing

Activity	Materials used	Personal protective equipment
Loading / removing food	None	Work wear as specified in country-specific standards and directives (BGR 111 in Germany) for kitchen work, in particular: <ul style="list-style-type: none"> ▪ Protective clothing ▪ Heat protective gloves (compliant with EN 407 in European Union) ▪ Safety boots
Handling the core temperature probe (option)	None	Work wear as specified in country-specific standards and directives (BGR 111 in Germany) for kitchen work, in particular: <ul style="list-style-type: none"> ▪ Protective clothing ▪ Heat protective gloves (compliant with EN 407 in European Union)
Removing and fitting parts	Tools and equipment depend on the task	Work wear as specified in country-specific standards and directives (BGR 111 in Germany) for kitchen work, in particular: <ul style="list-style-type: none"> ▪ Protective clothing ▪ Heat protective gloves (compliant with EN 407 in European Union)

Cleaning

Activity	Used cleaning agents	Personal protective equipment
Oven cleaning of any kind	<ul style="list-style-type: none"> ▪ ConvoClean forte ▪ ConvoClean new 	<p>The protective equipment required will depend on the cleaning products being used and the selected cleaning method, and may include:</p> <ul style="list-style-type: none"> ▪ Breathing mask ▪ Safety goggles ▪ Protective gloves ▪ Protective clothing/apron <p>The EC safety datasheet for the relevant cleaning agent contains a more precise specification of these items. An up-to-date copy can be obtained from the manufacturer.</p> <p>Refer to the label on the cleaning agent concerned.</p>
Handling cleaning agent containers	<ul style="list-style-type: none"> ▪ ConvoCare K (concentrate) 	
Cleaning the triple glass door	Common household glass cleaner	Follow the instructions given by the manufacturer of the cleaning product you are using
Cleaning components and accessories according to relevant instructions	Common household detergent: mild on skin, alkali-free, pH-neutral and odourless	Follow the instructions given by the manufacturer of the cleaning product you are using
Cleaning the outside of the appliance case	Standard household stainless steel cleaner	Follow the instructions given by the manufacturer of the cleaning product you are using

4 Cooking procedures

4.1 Basic principles for loading the combi oven

4.1.1 Positioning the food containers

GN containers/baking tray sizes 1/1, 1/2; shelf grill

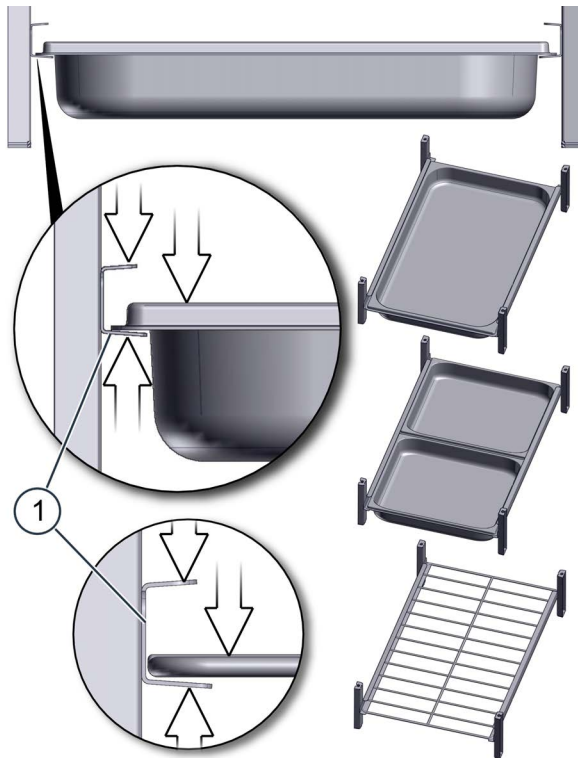

Rules for handling

- The containers or the shelf grill must be inserted as far as they will go **BETWEEN** the two arms of each U-rail (1).
- The containers or the shelf grill must be inserted in the U-rails at the same height on the left and right sides.
- The containers or shelf grill must **NOT** rest on the top arm of a U-rail.
- Containers must not be placed on the shelf grill.

4.1.2 Loading capacity for the combi oven

Maximum load for cooking

Applies to GN containers and for baking trays		6.10	10.10
Maximum load per appliance	[kg]	30	50
Maximum load per shelf	[kg]	15	15

Maximum number of food containers for cooking

GN rack, shelf spacing 68 mm		6.10	10.10
Number of GN 1/1 food containers	[Qty]	7	11
Number of GN 1/1 food containers when making full use of the shelf spacing	[Qty]	6	10

4.2 Operating principles and instructions for cooking

4.2.1 Turning the combi oven on and off

For your safety when using the combi oven

Before starting work, it is essential that you familiarize yourself with the rules and hazard warnings specified in the chapter 'For your safety on page 13' and in this instruction manual, and follow the instructions given there.

Basic rules for safe operation

If it is known or evident that the combi oven has been moved after installation without authorization (whether intentionally or unintentionally), the appliance must not be put back into service until all the following requirements have been met:



- The appliance and fittings or accessories being used show no signs of damage.
- The installed electrical power cables, water supply pipes and pipes for wastewater and cleaning products show no signs of damage, are fixed securely, are not leaking from any point and appear safe and in working order on visual inspection.
- The 'Requirements relating to the operating condition of the combi oven' on page 14 are met.
- The 'Requirements relating to the operating environment of the combi oven' are met.
- All warning signs are in their designated position.

Rules for safe operation of the appliance

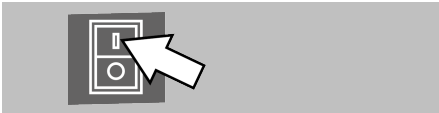
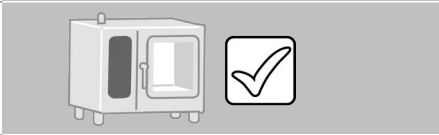

To avoid hazards, the following rules must be observed during operation:

- Air vent and ventilation port on the top of the appliance are not covered, adjusted or blocked.
- The racks must be fitted and attached securely.
- The food containers must be inserted correctly in accordance with the regulations specified in 'Positioning the cooking containers' on page 27.
- The suction panel must be secured properly in place.

Switching on the combi oven

- | | | |
|----|---|--|
| 1. |  | Switch on the combi oven. |
| 2. |  | Check that the oven light comes on while the appliance is running the self-diagnostics test. |
| 3. |  | Wait until the software is ready for use. |

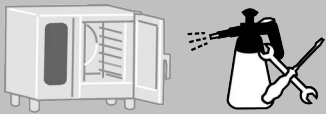
Switching off the combi oven at the end of the working day

- | | | |
|----|---|---|
| 1. |  An illustration showing a person in a white apron and black top cleaning the inside of an open combi oven door with a spray bottle and a brush. The oven is on a stand. | Perform the necessary cleaning tasks as specified in the cleaning and servicing schedule. |
| 2. |  An illustration of a hand turning a knob on the control panel of a combi oven. A white arrow points to the knob. | Switch off the combi oven. |
| 3. |  An illustration of a combi oven with its door slightly ajar, showing the interior racks. | Leave the appliance door ajar in order to let moisture escape. |

Switching off the combi oven before prolonged breaks in use

Switch off the water and power on site before prolonged breaks in use.

4.2.2 How to cook

⚠ For your safety when using the combi oven

Before starting work, it is essential that you familiarize yourself with the rules and hazard warnings specified in the chapter 'For your safety on page 13' and in this instruction manual, and follow the instructions given there.

Prior knowledge required





You need to know these operations:

- Opening and closing the appliance door safely 33
- Loading and removing food 35
- Putting away and retrieving the core temperature probe 37
- Using a USB stick 38



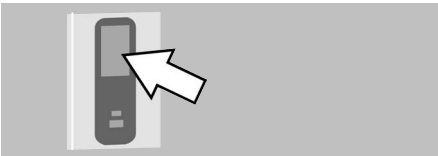

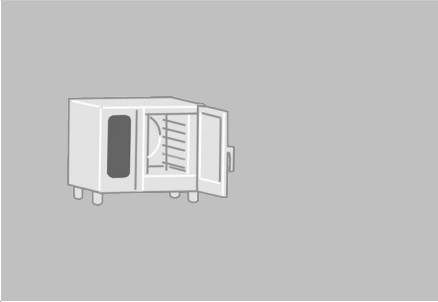
Requirements

- You are sufficiently familiar with using the software to be able to select saved cooking profiles or enter new cooking profiles that are suitable for the food you wish to cook, and to run these profiles, see operating instructions
- The combi oven and accessories and fittings used have been cleaned properly.
- There are no foreign objects in the cooking chamber.
- The oven drain is not blocked or clogged with any residues. The filter is fitted in place on the oven drain.
- The interior and intermediate glass panels of the appliance door are fitted properly.
- The suction panel is fitted and secured in place.
- The USB sliding-cover is covering the USB port.
- If the appliance sits on an open stand, there is no hot food in the stand giving off steam.
- The racks are fitted and secured.

How to cook

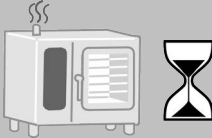
- | | | |
|----|---|---|
| 1. |  | Select a cooking profile from the cookbook or enter a new cooking profile.
Start the cooking operation. |
| 2. |  | Follow the prompts displayed by the software. <ul style="list-style-type: none"> ▪ If the oven is being preheated, wait for the process to finish and then proceed with step 4. ▪ If the oven is being cooled, proceed with step 3. |
| 3. |  | <div style="border: 1px solid black; padding: 2px; display: inline-block;">⚠ CAUTION</div> <p>Risk of scalding from hot steam and vapour</p> <ul style="list-style-type: none"> ▪ Expect to face a larger blast of steam than normal. ▪ Make sure that any bystanders step back from the appliance. ▪ Open the appliance door slowly and carefully. <p>Open the appliance door and wait for the process to finish.</p> |
| 4. |  | Place the prepared food in the combi oven. |

4 Cooking procedures

5.		Close the appliance door. Result: Cooking operation in progress.
6.		Wait for the cooking operation to finish.
7.		An audible signal is given when the cooking operation is finished. Follow the prompts displayed by the software.
8.		Open the appliance door.
9.		Take out the food.
10.		Close the appliance door again.

4.3 Specific Cooking Instructions

4.3.1 Opening and closing the appliance door safely



⚠ For your safety when using the combi oven

Before starting work, it is essential that you familiarize yourself with the rules and hazard warnings specified in the chapter 'For your safety on page 13' and in this instruction manual, and follow the instructions given there.

Requirements

- Make sure that the appliance is secured against slipping if placed on a work surface.

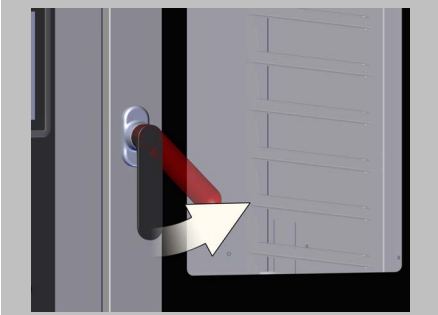
Opening the appliance door safely

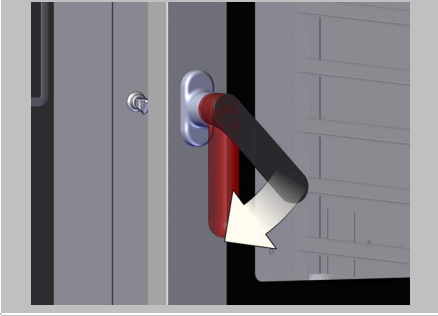
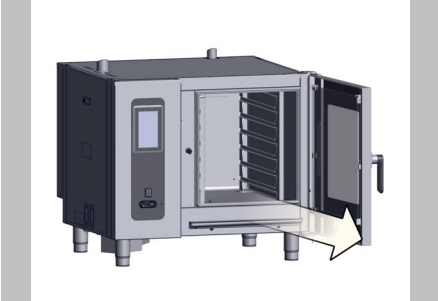
-  Turn the door handle to the right.
Result:
The appliance door is released.
-  **⚠ WARNING**
Risk of scalding from hot steam and vapour
 - Always open the appliance door slowly and carefully.
 - Always use the latch position of the appliance door.Open the appliance door by the door handle as far as its latch position at 5°.
- 
 - Turn the door handle back to its initial position.
 - Wait until any hot steam and vapour has escaped.
-  Open the appliance door fully.

Closing the appliance door safely

- Close the appliance door with a gentle slam.
- You can make sure that the appliance door is properly closed when a cooking profile or cleaning profile is in progress by checking that the cooking profile or cleaning profile is still running.

4.3.2 Loading and removing food

⚠ For your safety when using the combi oven

Before starting work, it is essential that you familiarize yourself with the rules and hazard warnings specified in the chapter 'For your safety on page 13' and in this instruction manual, and follow the instructions given there.

Prior knowledge required

You need to know these operations:

- Opening and closing the appliance door safely

33

Requirements

- The racks are fitted and secured.
- The weight of the food does not exceed the maximum loading weight.
- The food containers have the correct GN dimensions to fit.

Placing food in the combi oven

1.



Open the appliance door.

2.



⚠ WARNING

Risk of scalding from hot liquids

- Make sure you insert the containers, baking trays and shelf grills correctly into the right rails as specified in 'Positioning the food containers' on page 27.

Place the food onto the required shelf levels.

- Start from the bottom.
- Always slide in containers, baking trays or shelf grills as far as they will go.

Removing food

1.



Open the appliance door.

2.



Keep the food containers horizontal when removing.

4.3.3 Putting away and retrieving the core temperature probe

⚠ For your safety when using the combi oven

Before starting work, it is essential that you familiarize yourself with the rules and hazard warnings specified in the chapter 'For your safety on page 13' and in this instruction manual, and follow the instructions given there.

Prior knowledge required

You need to know these operations:

- Opening and closing the appliance door safely

33

Purpose

The core temperature probe must be stowed away when it is not needed for the cooking operation. Otherwise the probe risks getting damaged.

Putting away the core temperature probe

1.

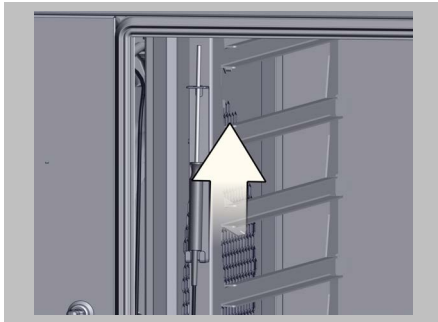

Slide the core temperature probe into the holder on the left-hand rack.

NOTICE! Keep the cable tidy.

Do not let the cable get trapped between the appliance door and the hygienic plug-in gasket when closing the appliance door.

Retrieving the core temperature probe

1.



⚠ CAUTION

Risk of stab wounds from sharp-ended parts

- Take care when handling the core temperature probe.

Pull the core temperature probe carefully out of the holder on the left-hand rack.

4.3.4 Using a USB stick

⚠ For your safety when using the combi oven

Before starting work, it is essential that you familiarize yourself with the rules and hazard warnings specified in the chapter 'For your safety on page 13' and in this instruction manual, and follow the instructions given there.

Purpose of the USB sliding cover

The sliding cover protects the USB port so that no water vapour can get into the control electronics during cooking or cleaning.

During cooking and cleaning, make sure that any USB stick has been removed and that the USB port is closed by the sliding cover.

Inserting the USB stick

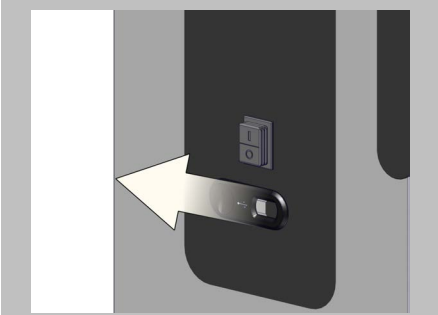
1.  Slide the sliding cover on the USB port to the left.

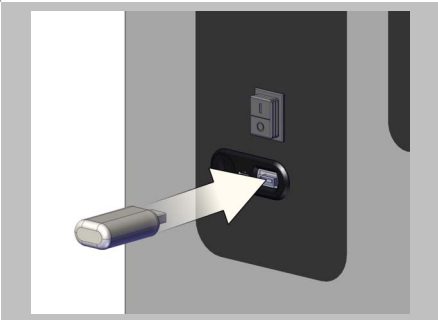
2.  Plug in the USB stick.
If the USB stick is too large, use a standard commercial adapter cable.

4.3.5 Inserting and removing racks

⚠ For your safety when using the combi oven

Before starting work, it is essential that you familiarize yourself with the rules and hazard warnings specified in the chapter 'For your safety on page 13' and in this instruction manual, and follow the instructions given there.

Prior knowledge required

You need to know these operations:

- Opening and closing the appliance door safely 33
- Putting away and retrieving the core temperature probe 37

Requirements

- All food containers and other accessories used for cooking have been removed from the cooking chamber.
- Remove the core temperature probe (option) from the left-hand rack.

Removing the rack

1.

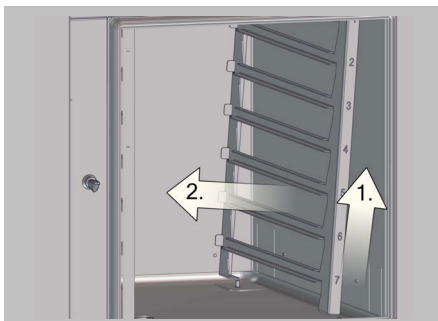

Lift up (1) the rack until you are able to pivot it away (2) from the two bottom fixing studs.

2.

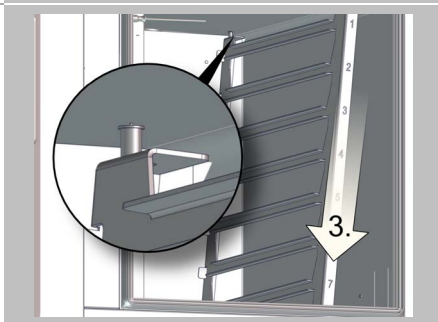

- Detach (3) the rack from the top fixing studs by pulling it downwards.
- Remove the rack from the cooking chamber.

Fitting the rack

1.

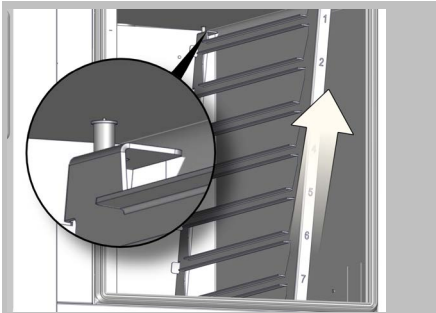

- Slide the rack onto the two top fixing studs until you are able to pivot it over the bottom fixing studs.
- Push the rack down fully over the bottom fixing studs.

2.

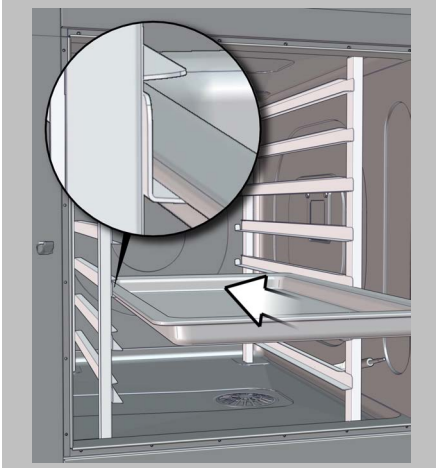

- Insert a food container just to check that you have fitted both racks correctly.
- Check that the food container is sitting correctly in the rails as specified in 'Positioning the food containers' on page 27.
- Stow away the core temperature probe (option) on the left-hand rack.

5 Cleaning procedures

5.1 Basic principles for cleaning the combi oven

5.1.1 Cleaning methods

Cleaning method

Cleaning method	Description	Criteria for use
Oven cleaning without using cleaning agents	<ul style="list-style-type: none"> A fully automatic process in which the temperature and program length are software-controlled. The cooking chamber is rinsed solely with water without using cleaning agents 	<ul style="list-style-type: none"> To remove very light soiling or odours between separate cooking operations To remove dust, for instance, from the intensively cleaned combi oven after a prolonged period out of use
Fully automatic oven cleaning using connected canisters ConvoClean	<ul style="list-style-type: none"> A fully automatic process in which the temperature, program length, use of cleaning agents and rinsing are software-controlled. The software controls how much cleaning agent is dispensed, with the cleaning fluids supplied automatically to the cooking chamber from connected canisters. 	<ul style="list-style-type: none"> Daily cleaning after all cooking operations are finished for the day Before putting the combi oven into operation for the first time, to clean the cooking chamber of all dirt accumulated during transportation, setting-up and installation. After servicing work on the combi oven to remove all dirt from the cooking chamber
Oven cleaning only using rinse aid from connected canister ConvoCare	<ul style="list-style-type: none"> A fully automatic process in which the temperature, program length, use of rinse aid and rinsing are software-controlled. The rinse aid is dispensed automatically into the cooking chamber from the connected canister. 	<ul style="list-style-type: none"> As an extra cleaning process after fully automatic oven cleaning if some of the dirt still remains If there is a white deposit or dark discolouration in the cooking chamber
Oven cleaning by hand	<ul style="list-style-type: none"> An entirely manual process without software support <ul style="list-style-type: none"> The cooking chamber is not heated The user controls how long the cleaning agents are left to act. The cleaning agents are sprayed into the cooking chamber by hand. The cooking chamber is rinsed out manually with a water spray or alternatively wiped out thoroughly using plenty of water and a soft cloth 	<ul style="list-style-type: none"> To remove dirt or odours between separate cooking operations after the cooking chamber has cooled down As an extra cleaning process after fully automatic oven cleaning if some of the dirt still remains For cleaning specific areas of the cooking chamber such as the oven drain If there is a white deposit or dark discolouration in the cooking chamber

Visual check for no residues after cleaning

After completion of any of the specified cleaning methods, always carry out a visual inspection to check that no residues have been left by the cleaning process.

5.1.2 Cleaning instructions

Overview

The figure below shows a size 6.10 combi oven as an example of all combi ovens:

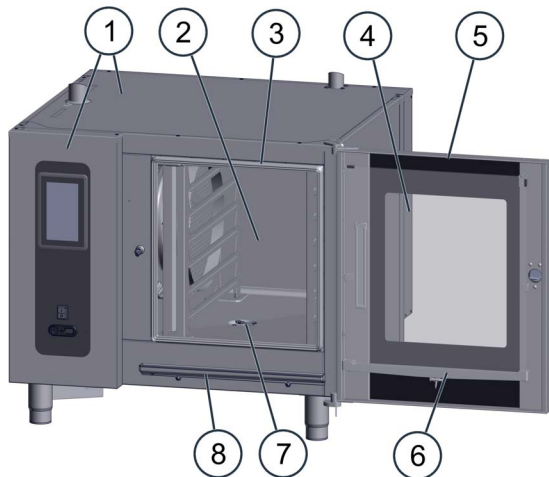

Item	Name
1	Outside of appliance case including control panel exterior
2	Cooking chamber
3	Hygienic plug-in gasket
4	Triple glass door
5	Appliance door
6	Door drip tray
7	Oven drain with filter
8	Appliance drip tray

Daily cleaning tasks

More frequent cleaning may be necessary depending on the degree of soiling.

What must be cleaned?	Procedure	Cleaning agents
Cooking chamber	'How to perform fully automatic oven cleaning' on page 46	ConvoClean new or forte and ConvoCare
Oven drain	<ul style="list-style-type: none"> Remove any residues Rinse out to prevent blockage Spray cleaning agent into the drain and rinse with water 	<ul style="list-style-type: none"> Use an external water spray ConvoClean new or forte
Outside of appliance case including control panel exterior	<p>Clean by hand with a soft cloth</p> <p>Rules to be observed:</p> <ul style="list-style-type: none"> Never clean the outer case of the appliance with a water jet or water spray. Disconnect the appliance from the power supply when cleaning the outside of the appliance 	Standard household stainless steel cleaner
Containers, baking trays, shelf grills and other accessories used for cooking	<ul style="list-style-type: none"> Clean by hand using a soft, non-abrasive sponge Rinse off after with water 	Common household detergent
<p>Check the cooking chamber daily for signs of a white deposit or dark discolouration</p> <ul style="list-style-type: none"> Clean only when needed 	<ul style="list-style-type: none"> By hand: <ul style="list-style-type: none"> Spray on cleaner when oven is cold Leave to work for 10 minutes Polish with a soft, non-abrasive sponge Rinse out or 'How to perform cooking chamber cleaning using only rinse aid' on page 50 	ConvoCare

Weekly cleaning tasks

More frequent cleaning may be necessary depending on the degree of soiling.

What must be cleaned?	Procedure	Cleaning agents
Interior glass panel of the triple glass door	'How to clean the interior glass panel of the triple glass door' on page 52	Common household glass cleaner
Cooking chamber behind suction panel	'How to clean the cooking chamber behind the suction panel' on page 54	ConvoClean new or forte
Hygienic plug-in gasket around appliance door	<ul style="list-style-type: none"> ▪ Wipe all around by hand with a soft cloth and cleaning agent ▪ Wipe off thoroughly with a soft cloth and clean water ▪ Dry with a soft cloth ▪ To let the hygienic plug-in gasket dry, leave the appliance door ajar (do not shut it tight) 	Common household detergent
Appliance door, door drip tray and appliance drip tray	<ul style="list-style-type: none"> ▪ Clean by hand using a soft cloth and cleaning agent ▪ Wipe off thoroughly with a soft cloth and clean water ▪ Dry with a soft cloth 	ConvoClean new or forte

Monthly cleaning tasks

More frequent cleaning may be necessary depending on the degree of soiling.

What must be cleaned?	Procedure	Cleaning agents
Intermediate glass panel of the triple glass door	'How to clean the intermediate glass panel of the triple glass door' on page 52	Common household glass cleaner
Intensive cleaning of hygienic plug-in gasket	'How to perform intensive cleaning of the hygienic plug-in gasket' on page 55	Common household detergent
Stand (option)	Clean by hand with a soft cloth	Standard household stainless steel cleaner

Additional stipulated cleaning tasks

The following cleaning tasks are stipulated in addition to the regular cleaning tasks:

- The appliance must be cleaned before first use.
- The appliance must be cleaned before and after any periods out of use.
- The appliance must be cleaned after any servicing work.

5.1.3 Cleaning agents

Cleaning agents

Use solely the cleaning agents specified here to clean the combi oven and its accessories.

Product	Use	Container
ConvoClean new for light soiling	Oven cleaning by hand	Spray bottle
<ul style="list-style-type: none"> Not intended for cleaning containers, baking trays, shelf grills or other accessories 	Fully automatic oven cleaning	Cleaning-fluid canisters located under the combi oven and connected to the cleaning system
ConvoClean forte for normal to heavy soiling	Oven cleaning by hand	Spray bottle
<ul style="list-style-type: none"> Not intended for cleaning containers, baking trays, shelf grills or other accessories 	Fully automatic oven cleaning	Cleaning-fluid canisters located under the combi oven and connected to the cleaning system
ConvoCare K (concentrate)	For mixing a ready-to-use ConvoCare solution in the specified mixture ratio	-
ConvoCare Rinse aid in the specified mixing ratio	<ul style="list-style-type: none"> Fully automatic oven cleaning Oven cleaning using only rinse aid (ConvoCare cleaning profile) 	Cleaning-fluid canisters located under the combi oven and connected to the cleaning system
<ul style="list-style-type: none"> Not intended for cleaning containers, baking trays, shelf grills or other accessories 	Manual aftercare of cooking chamber interior	Spray bottle
Standard household stainless steel cleaner	Caring for the external surfaces of the combi oven	-
Common household glass cleaner	Cleaning the triple glass door	-
Common household detergent: mild on skin, alkali-free, pH-neutral and odourless	<ul style="list-style-type: none"> Cleaning components and fittings according to relevant instructions Cleaning containers, baking trays, shelf grills and other accessories used for cooking 	-

Using cleaning agents

You must wear personal protective equipment when using certain cleaning agents.

Follow the instructions given in the chapter 'Personal protective equipment' on page 26 and the current EC safety datasheets pertaining to the ConvoClean forte, ConvoClean new, ConvoCare K (concentrate) and ConvoCare S cleaning products.

Personnel must be trained regularly by the owner of the combi oven.

5.1.4 Preparing the cleaning agents

Preparing the cleaning agents

Preparation form	Handling / Usage	Cleaning agents
Spray bottle	<ul style="list-style-type: none"> ▪ Never leave the spray bottle unused under pressure for prolonged periods. Open the pump head slowly to release the pressurized air. ▪ Rinse out the spray bottle weekly. ▪ Rinse out the nozzle, nozzle extension and nozzle pipe after each use. ▪ Do not store the spray bottles containing cleaning agents in the immediate vicinity of the combi oven but keep in dedicated storage areas away from food. 	<ul style="list-style-type: none"> ▪ ConvoClean new ▪ ConvoClean forte ▪ ConvoCare
Canister	<ul style="list-style-type: none"> ▪ Connect the canisters containing the cleaning agents to the combi oven cleaning system. ▪ Before every fully automatic oven cleaning program, check that there is enough cleaning agent in each canister. ▪ Do not store the spare canisters containing cleaning agents in the immediate vicinity of the combi oven but keep in dedicated storage areas away from food. 	<ul style="list-style-type: none"> ▪ ConvoClean new ▪ ConvoClean forte ▪ ConvoCare
	<ul style="list-style-type: none"> ▪ Only use ConvoCare K (concentrate) for mixing the ready-to-use ConvoCare solution (in the specified mixture ratio) in an empty canister. ▪ Do not store canisters containing ConvoCare K in the immediate vicinity of the combi oven but keep in dedicated storage areas away from food. 	<ul style="list-style-type: none"> ▪ ConvoCare K (concentrate)

5.2 Operating principles and instructions for cleaning

5.2.1 How to perform fully automatic oven cleaning

▲ For your safety when using the combi oven

Before starting work, it is essential that you familiarize yourself with the rules and hazard warnings specified in the chapter 'For your safety on page 13' and in this instruction manual, and follow the instructions given there.

Prior knowledge required



You need to know these operations:

- Opening and closing the appliance door safely 33
- Replacing the rinse aid canister 56
- Replacing the cleaning agent canister 59

Requirements

- You are sufficiently familiar with using the software to be able to select and run different cleaning profiles; please refer to the Operating instructions for the combi oven.
- No food has been left in the cooking chamber.
- There are no foreign objects in the cooking chamber.
- All containers, baking trays, shelf grills and any other accessories have been removed from the cooking chamber.
- The oven drain is not blocked or clogged with any residues. The filter is fitted in place on the oven drain.
- The interior and intermediate glass panels of the appliance door are fitted properly.
- The suction panel is fitted and secured in place.
- The USB sliding-cover is covering the USB port.
- The appliance door is closed.
- You have provided the necessary cleaning resources for your cleaning program; see 'Preparing the cleaning agents' on page 45.

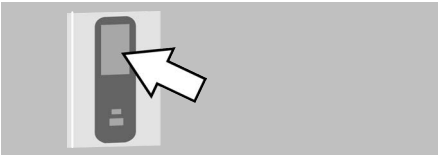
How to perform fully automatic cooking chamber cleaning using connected canisters

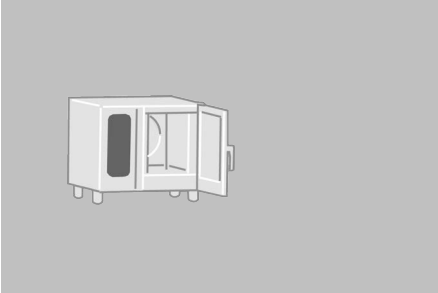
1.  Select the cleaning profile and start the cleaning process.
2.  Follow the prompts displayed by the software.
 - If the oven is being preheated, wait for the process to finish and then proceed with step 4.
 - If the oven is being cooled, proceed with step 3.
3. 





▲ CAUTION

Risk of scalding from hot steam and vapour

 - Expect to face a larger blast of steam than normal.
 - Make sure that any bystanders step back from the appliance.
 - Open the appliance door slowly and carefully.

Open the appliance door and wait for the process to finish.

5 Cleaning procedures

4.		Close the appliance door. Result: Cleaning process in progress.
5.		⚠ CAUTION Risk of skin and eye irritation or chemical burns <ul style="list-style-type: none">Do not open the appliance door during the cleaning operation until prompted by the software. Wait for the cleaning operation to finish.
6.		An audible signal is given when the cleaning process is finished. Follow the prompts displayed by the software.
7.		<ul style="list-style-type: none">Open the appliance door and check the cleaning result. The cooking chamber should look clean and not smell of leftover food or cleaning agents.Check the cooking chamber for any foreign matter that may have entered with the rinse water. Remove any foreign matter.If the cleaning result is not good enough, either clean and rinse the cooking chamber manually or run a cleaning profile again.
8.		Leave the appliance door ajar to let the cooking chamber dry out.

5.2.2 How to clean the cooking chamber without using cleaning agents

⚠ For your safety when using the combi oven

Before starting work, it is essential that you familiarize yourself with the rules and hazard warnings specified in the chapter 'For your safety on page 13' and in this instruction manual, and follow the instructions given there.

Prior knowledge required

You need to know these operations:





- Opening and closing the appliance door safely

33

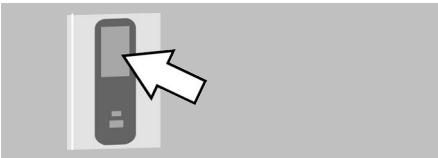

Requirements

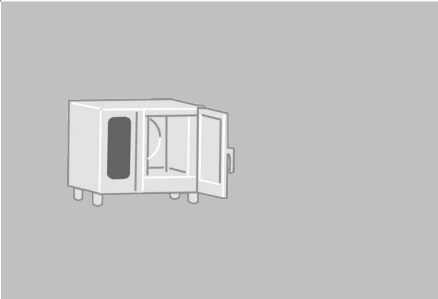
- You are sufficiently familiar with using the software to be able to select and run different cleaning profiles; please refer to the Operating instructions for the combi oven.
- No food has been left in the cooking chamber.
- There are no foreign objects in the cooking chamber.
- The oven drain is not blocked or clogged with any residues. The filter is fitted in place on the oven drain.
- The interior and intermediate glass panels of the appliance door are fitted properly.
- The suction panel is fitted and secured in place.
- The USB sliding-cover is covering the USB port.
- The appliance door is closed.

How to clean the cooking chamber without using cleaning agents

1.		Select the cleaning profile and start the cleaning process.
2.		Follow the prompts displayed by the software. <ul style="list-style-type: none"> ▪ If the oven is being preheated, wait for the process to finish and then proceed with step 4. ▪ If the oven is being cooled, proceed with step 3.
3.		<div style="border: 1px solid black; padding: 2px; display: inline-block;">⚠ CAUTION</div> <p>Risk of scalding from hot steam and vapour</p> <ul style="list-style-type: none"> ▪ Expect to face a larger blast of steam than normal. ▪ Make sure that any bystanders step back from the appliance. ▪ Open the appliance door slowly and carefully. <p>Open the appliance door and wait for the process to finish.</p>
4.		Close the appliance door. Result: Cleaning process in progress.
5.		Wait for the cleaning operation to finish.

5 Cleaning procedures

6.		<p>An audible signal is given when the cleaning process is finished. Follow the prompts displayed by the software.</p>
7.		<ul style="list-style-type: none">▪ Open the appliance door and check whether the expected cleaning result has been achieved.▪ Check the cooking chamber for any foreign matter that may have entered with the rinse water. Remove any foreign matter.▪ If necessary, either clean and rinse the cooking chamber manually or run another cleaning profile.
8.		<p>Leave the appliance door ajar to let the cooking chamber dry out.</p>

5.2.3 How to perform oven cleaning using only rinse aid

⚠ For your safety when using the combi oven

Before starting work, it is essential that you familiarize yourself with the rules and hazard warnings specified in the chapter 'For your safety on page 13' and in this instruction manual, and follow the instructions given there.

Prior knowledge required

You need to know these operations:

- Opening and closing the appliance door safely

33

Requirements

- You are sufficiently familiar with using the software to be able to select and run different cleaning profiles; please refer to the Operating instructions for the combi oven.
- No food has been left in the cooking chamber.
- There are no foreign objects in the cooking chamber.
- All containers, baking trays, shelf grills and any other accessories have been removed from the cooking chamber.
- The oven drain is not blocked or clogged with any residues. The filter is fitted in place on the oven drain.
- The interior and intermediate glass panels of the appliance door are fitted properly.
- The suction panel is fitted and secured in place.
- The USB sliding-cover is covering the USB port.
- The appliance door is closed.
- You have provided the necessary cleaning resources for your cleaning program; see 'Preparing the cleaning agents' on page 45.

How to perform cooking chamber cleaning using only rinse aid from connected canisters

The cleaning workflow for the ConvoCare cleaning profile using connected canisters is identical to the cleaning workflow described under 'How to perform fully automatic oven cleaning' on page 46.

5.2.4 How to clean the cooking chamber by hand

⚠ For your safety when using the combi oven

Before starting work, it is essential that you familiarize yourself with the rules and hazard warnings specified in the chapter 'For your safety on page 13' and in this instruction manual, and follow the instructions given there.

Prior knowledge required







You need to know these operations:

- Opening and closing the appliance door safely 33
- Inserting and removing racks 39
- Removing and fitting the suction panel 61

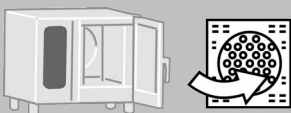
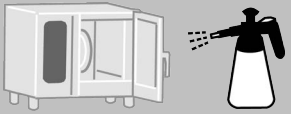
Requirements

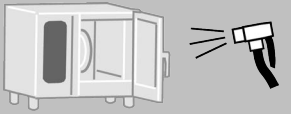
- The appliance is off and entirely without power.
- The cooking chamber has cooled down to < 60 °C after its last use.
- You have the required cleaning agent available for use: spray bottle containing ConvoClean new or ConvoClean forte; see 'Preparing the cleaning agents' on page 45
- The oven drain is not blocked or clogged with any residues.
- The USB sliding-cover is covering the USB port.
- The racks are removed.

How to clean the cooking chamber by hand

- | | | |
|----|---|---|
| 1. |  | Remove the suction panel. |
| 2. |  | Use the spray bottle to spray cleaning agent around the cooking chamber, on the suction panel and in the area behind the suction panel. |
| 3. |  | Leave the cleaning agent to work for 10 to 20 minutes. |
| 4. |  | Rinse out the suction panel from all sides, the area behind the suction panel and the entire cooking chamber thoroughly with an external water spray, or wipe out the cooking chamber, the accessories and the area behind the suction panel thoroughly with plenty of water and a soft cloth.
For heavy soiling, you can repeat the cleaning process. |
| 5. |  | Refit the suction panel. |
| 6. |  | Check that the suction panel is fitted correctly: <ul style="list-style-type: none"> ▪ The suction panel is in place and secured at the top and bottom. |
| 7. |  | Leave the appliance door ajar to let the cooking chamber dry out. |

5.2.5 How to clean the interior glass panel of the triple glass door

⚠ For your safety when using the combi oven

Before starting work, it is essential that you familiarize yourself with the rules and hazard warnings specified in the chapter 'For your safety on page 13' and in this instruction manual, and follow the instructions given there.

Prior knowledge required

You need to know these operations:

- Opening and closing the appliance door safely 33
- Removing and fitting the interior glass panel of the triple glass door 64

Requirements

- The cooking chamber has cooled down to ambient temperature after its last use.
- You have household glass cleaner available as the necessary cleaning product.
- You have several (at least three) soft clean cloths available for use.

How to clean the interior glass panel of the triple glass door

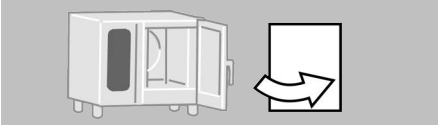
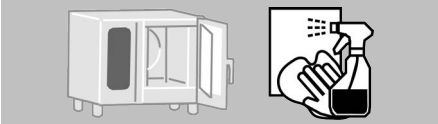
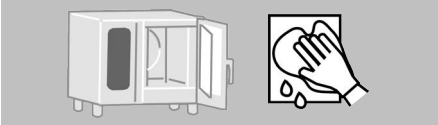
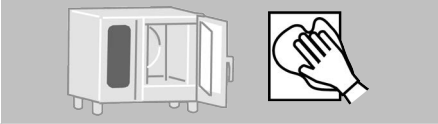
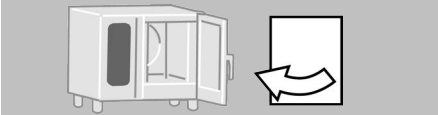
- | | | |
|----|---|---|
| 1. |  | Open the appliance door and remove the interior glass panel. |
| 2. |  | Use a soft clean cloth and the cleaning product to clean both sides of the interior glass panel and the external surface of the exterior glass panel of the triple glass door. Take care not to scratch the glass as you clean. |
| 3. |  | Use a soft clean cloth and clean water to wipe off both sides of the interior glass panel and the external surface of the exterior glass panel of the triple glass door. |
| 4. |  | Use a soft clean cloth to dry both sides of the interior glass panel and the external surface of the exterior glass panel of the triple glass door. |
| 5. |  | Refit the interior glass panel. |

5.2.6 How to clean the intermediate glass panel of the triple glass door

⚠ For your safety when using the combi oven

Before starting work, it is essential that you familiarize yourself with the rules and hazard warnings specified in the chapter 'For your safety on page 13' and in this instruction manual, and follow the instructions given there.

Prior knowledge required

You need to know these operations:

- Opening and closing the appliance door safely 33
- Removing and fitting the interior glass panel of the triple glass door 64
- Removing and fitting the intermediate glass panel of the triple glass door 66

Requirements

- The cooking chamber has cooled down to ambient temperature after its last use.
- You have household glass cleaner available as the necessary cleaning product.
- You have several (at least three) soft clean cloths available for use.
- The appliance door is open and the interior glass panel of the triple glass door has been removed.

How to clean the intermediate glass panel of the triple glass door

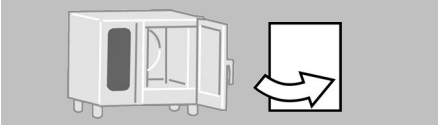
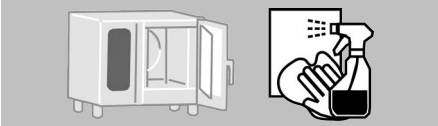
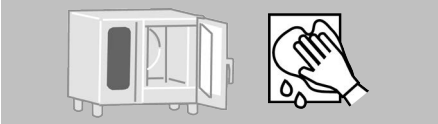
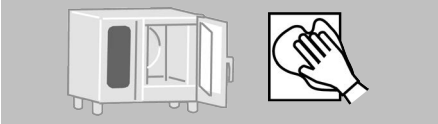
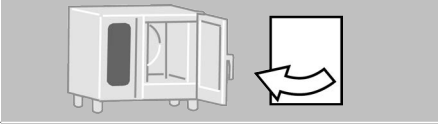
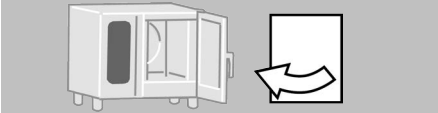
- | | | |
|----|---|--|
| 1. |  | Remove the intermediate glass panel. |
| 2. |  | Use a soft clean cloth and the cleaning product to clean both sides of the interior, intermediate and exterior glass panels of the triple glass door. Take care not to scratch the glass as you clean. |
| 3. |  | Use a soft clean cloth and clean water to wipe off both sides of the interior, intermediate and exterior glass panels of the triple glass door. |
| 4. |  | Use a soft clean cloth to dry both sides of the interior, intermediate and exterior glass panels of the triple glass door. |
| 5. |  | Refit the intermediate glass panel. |
| 6. |  | Refit the interior glass panel. |

5.2.7 How to clean the cooking chamber behind the suction panel

⚠ For your safety when using the combi oven

Before starting work, it is essential that you familiarize yourself with the rules and hazard warnings specified in the chapter 'For your safety on page 13' and in this instruction manual, and follow the instructions given there.

Prior knowledge required





You need to know these operations:

- Opening and closing the appliance door safely 33
- Inserting and removing racks 39
- Removing and fitting the suction panel 61

Requirements

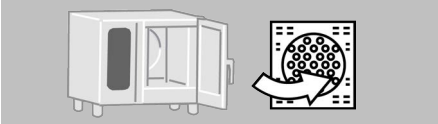
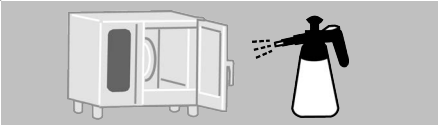
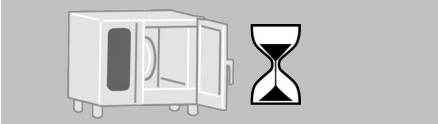
- The cooking chamber has cooled down to < 60 °C after its last use.
- You have the required cleaning agent available for use: spray bottle containing ConvoClean new or ConvoClean forte; see 'Preparing the cleaning agents' on page 45
- The oven drain is not blocked or clogged with any residues.
- The left-hand rack has been removed.

How to clean the cooking chamber behind the suction panel

- | | | |
|----|---|---|
| 1. |  | Remove the suction panel. |
| 2. |  | Use the spray bottle to spray the cleaning agent onto all sides of the suction panel and onto the area behind the suction panel. |
| 3. |  | Leave the cleaning agent to work for 10 to 20 minutes. |
| 4. |  | Rinse out the suction panel from all sides, the area behind the suction panel and the entire cooking chamber thoroughly with an external water spray, or wipe out the cooking chamber, the accessories and the area behind the suction panel thoroughly with plenty of water and a soft cloth.
For heavy soiling, you can repeat the cleaning process. |
| 5. |  | Refit the suction panel. |
| 6. |  | Check that the suction panel is fitted correctly: <ul style="list-style-type: none"> ▪ The suction panel is in place and secured at the top and bottom. |
| 7. |  | Leave the appliance door ajar to let the cooking chamber dry out. |

5.2.8 How to perform intensive cleaning of the hygienic plug-in gasket

⚠ For your safety when using the combi oven

Before starting work, it is essential that you familiarize yourself with the rules and hazard warnings specified in the chapter 'For your safety on page 13' and in this instruction manual, and follow the instructions given there.

Prior knowledge required







You need to know these operations:

- Opening and closing the appliance door safely 33
- Removing and fitting the hygienic plug-in gasket 63

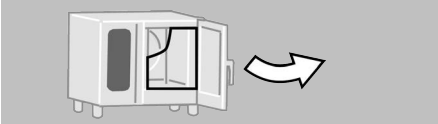
Requirements

- The cooking chamber has cooled down to < 60 °C after its last use.
- You have household detergent available as the necessary cleaning product.
- You have several (at least three) soft clean cloths available for use.

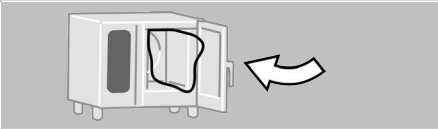
How to perform intensive cleaning of the hygienic plug-in gasket

- | | | |
|----|---|---|
| 1. |  | Open the appliance door and remove the hygienic plug-in gasket. |
| 2. |  | Use a soft clean cloth and the cleaning product to clean the hygienic plug-in gasket in a sink. |
| 3. |  | Use a soft clean cloth and clean water to rinse off the hygienic plug-in gasket in a sink. |
| 4. |  | Use a soft clean cloth to dry the hygienic plug-in gasket thoroughly. |
| 5. |  | Refit the hygienic plug-in gasket around the mouth of the cooking chamber. |
| 6. |  | Leave the appliance door open to let the hygienic plug-in gasket dry off completely. |

5.3 Specific Cleaning Instructions

5.3.1 Replacing the rinse aid canister

⚠ For your safety when using the combi oven

Before starting work, it is essential that you familiarize yourself with the rules and hazard warnings specified in the chapter 'For your safety on page 13' and in this instruction manual, and follow the instructions given there.

Materials required

- One empty canister (10 litres) for the ConvoCare rinse aid
- Enough soft water (approx. 10 litres); (for specification see the 'Water quality' section of the 'Technical data' in the Installation manual)
- ConvoCare K concentrate (0.33 l)

Mix up the ConvoCare rinse aid in the canister

To avoid excessive foaming, follow the procedure below when mixing the ConvoCare K concentrate with soft water to produce the rinse aid:

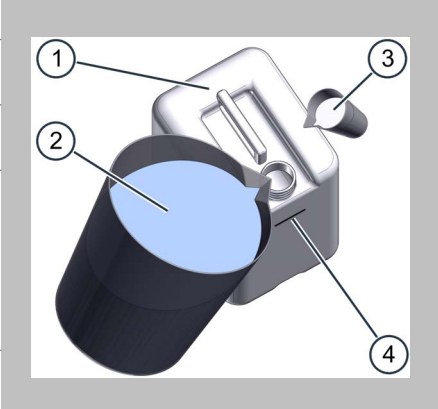
- | | | |
|----|--|---|
| 1. |  | Open the empty canister (1). |
| 2. | | Fill the canister with soft water (2) until it reaches just below the 10 litre mark (4). |
| 3. | | Then pour 0.33 l of the ConvoCare K concentrate (3) carefully into the canister (1). |
| 4. | | Check the fluid level in the canister: <ul style="list-style-type: none">▪ If the level is below the 10 litre mark (4), carefully add the extra amount of soft water (2) required.▪ If the level is above the 10 litre mark (4), the rinse aid is a little less concentrated than specified. You can still use the rinse aid at the lower concentration. |
| 5. | | Replace the cap on the canister and tip it up to mix the liquids together thoroughly. |

Replacing the rinse aid canister

1.

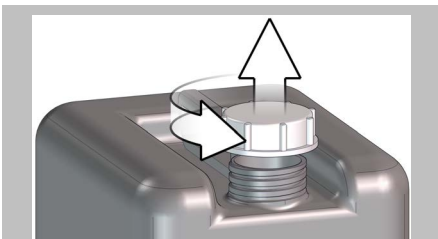

Remove the cap from the ConvoCare rinse aid mixing canister.

2.

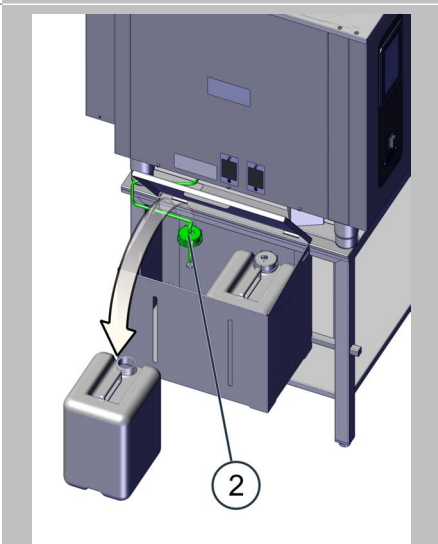

- Locate the canister that is connected by the (green) tube to the rinse aid connector (F) underneath the appliance on the left-hand side.
- Unscrew the (green) supply tube (2) plus suction nozzle from the located canister.
- Remove the empty rinse aid canister.

3.

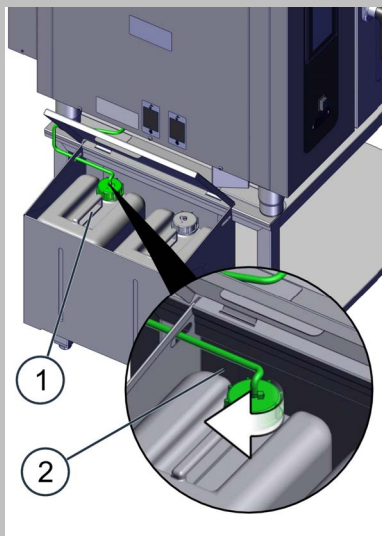

- Place ready the new canister (1) filled with rinse aid.
- Feed the (green) supply tube plus suction nozzle (2) into the full canister (1) and screw it on.
- Make sure that there are no kinks in the tube and that the vent hole on the canister cap is unobstructed.

4.

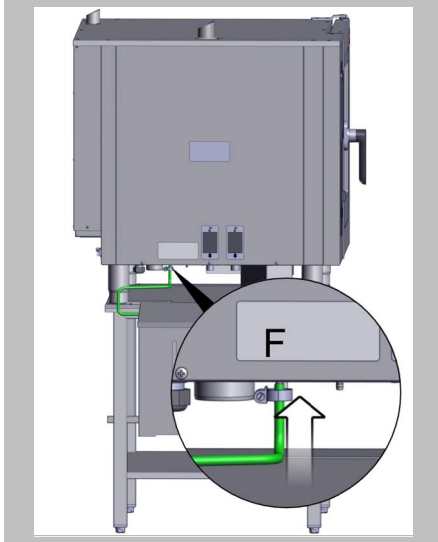

- Check the position of the canisters:
 - The surface on which the canisters sit must not lie above the level at which the appliance feet meet the appliance case.
 - The surface on which the canisters sit must not lie more than 1 metre below this level.
- Check that you have connected the tube to the correct connector.
- The rinse aid must be attached to appliance connector F.
(The colour green is used throughout.)

5.3.2 Replacing the cleaning agent canister

⚠ For your safety when using the combi oven

Before starting work, it is essential that you familiarize yourself with the rules and hazard warnings specified in the chapter 'For your safety on page 13' and in this instruction manual, and follow the instructions given there.

Materials required

- ConvoClean new or ConvoClean forte replacement canister

Replacing the cleaning agent canister

1.

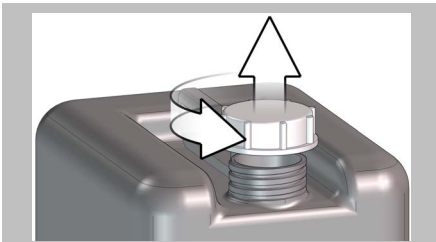

Remove the seal on the replacement canister for the ConvoClean new or ConvoClean forte cleaning agent.

2.

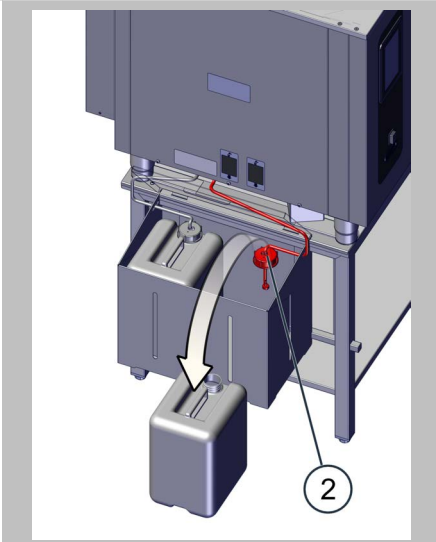

- Locate the canister that is connected by the (red) tube to the cleaning agent connector (G) underneath the appliance on the left-hand side.
- Unscrew the (red) supply tube (2) plus suction nozzle from the located canister.
- Remove the empty cleaning agent canister.

3.

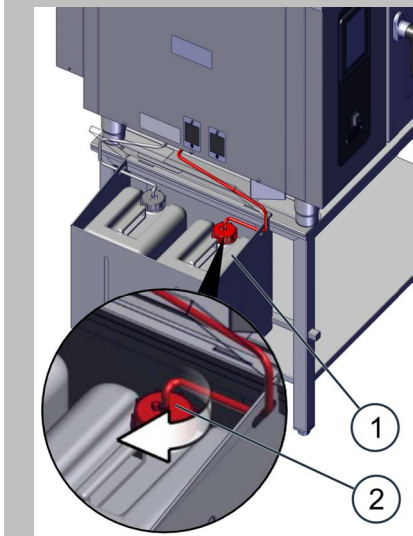

- Place ready the new canister (1) filled with cleaning agent.
- Feed the (red) supply tube plus suction nozzle (2) into the full canister (1) and screw it on.
- Make sure that there are no kinks in the tube and that the vent hole on the canister cap is unobstructed.

4.

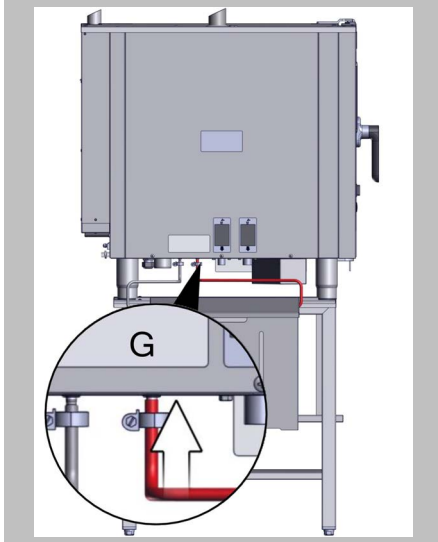

- Check the position of the canisters:
 - The surface on which the canisters sit must not lie above the level at which the appliance feet meet the appliance case.
 - The surface on which the canisters sit must not lie more than 1 metre below this level.
- Check that you have connected the tube to the correct connector.
- The cleaning agent must be attached to appliance connector G.
(The colour red is used throughout.)

5.3.3 Removing and fitting the suction panel

⚠ For your safety when using the combi oven

Before starting work, it is essential that you familiarize yourself with the rules and hazard warnings specified in the chapter 'For your safety on page 13' and in this instruction manual, and follow the instructions given there.

Prior knowledge required

You need to know these operations:

- Opening and closing the appliance door safely 33
- Inserting and removing racks 39

Materials required

Wide flat-blade screwdriver

Requirements

- The appliance is off and entirely without power.
- The cooking chamber has cooled down to < 60 °C after its last use.
- The left-hand rack has been removed.

Removing the suction panel

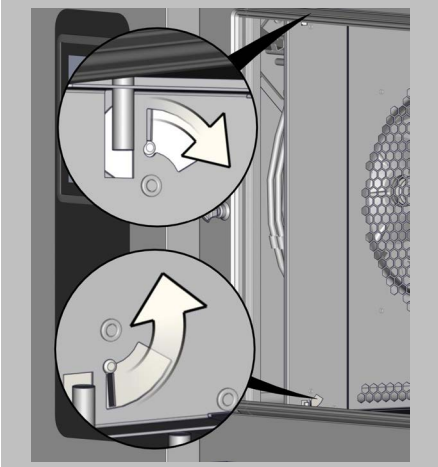
1.  Use the tool to release the fasteners, top and bottom.

2. 
 - Pull the suction panel away slightly from the securing studs at top and bottom.
 - Detach the suction panel from the rear fixing stud and take it out of the cooking chamber.

Fitting the suction panel

1.

2.



To fit the suction panel, follow the steps for removal in the reverse order.

Make sure that the top and bottom fasteners are secured in place.

5.3.4 Removing and fitting the hygienic plug-in gasket

⚠ For your safety when using the combi oven

Before starting work, it is essential that you familiarize yourself with the rules and hazard warnings specified in the chapter 'For your safety on page 13' and in this instruction manual, and follow the instructions given there.

Prior knowledge required

You need to know these operations:

- Opening and closing the appliance door safely

33

Requirements

- The cooking chamber has cooled down to < 60 °C after its last use.
- The appliance door is open.

Removing the hygienic plug-in gasket

1.



Pull off the hygienic plug-in gasket from around the mouth of the appliance door, starting from the corners.

Fitting the hygienic plug-in gasket

1.

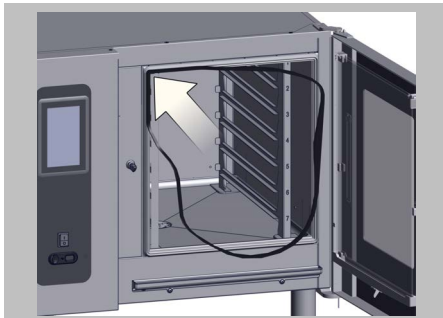

Refit the hygienic plug-in gasket first in the four corners, starting from one of the top corners.

2.

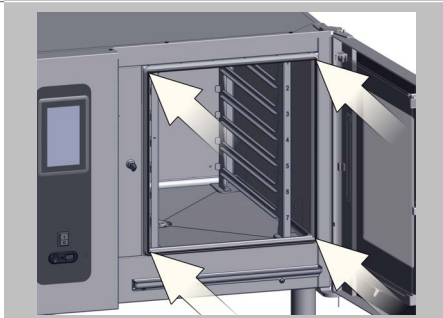

- Once all the corner sections are fitted, press the hygienic plug-in gasket carefully into the straight sections of the guide.
- Make sure that the hygienic plug-in gasket is seated tightly against the door and does not contain any kinks or curves.

5.3.5 Removing and fitting the interior glass panel of the triple glass door

⚠ For your safety when using the combi oven

Before starting work, it is essential that you familiarize yourself with the rules and hazard warnings specified in the chapter 'For your safety on page 13' and in this instruction manual, and follow the instructions given there.

Prior knowledge required

You need to know these operations:

- Opening and closing the appliance door safely

33

Requirements

- The cooking chamber has cooled down to ambient temperature after its last use.
- Your hands are clean and dry so that you can grip the interior glass panel securely.

Removing the interior glass panel

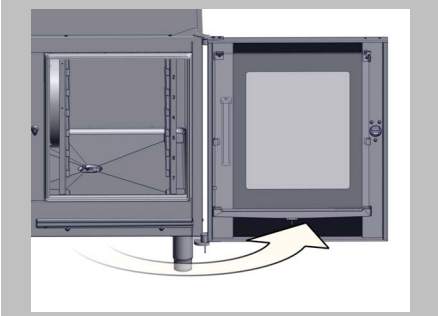
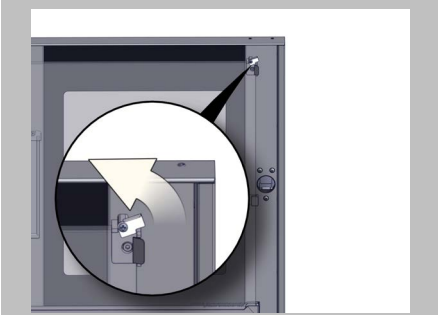
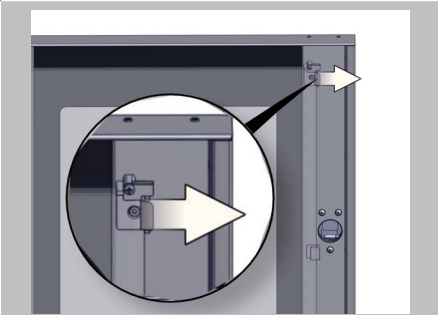
-  1. Open the appliance door.
-  2. Rotate upwards the catch for the interior glass panel on the top right bracket.
-  3. Push on the spring clip on the top right bracket and pivot the interior glass panel slightly out of the bracket.

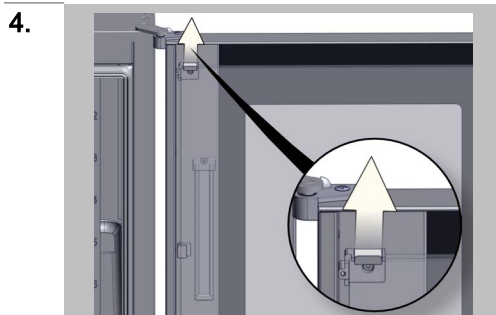

- Hold the interior glass panel firmly from the top.
- Press on the spring clip on the top left bracket.

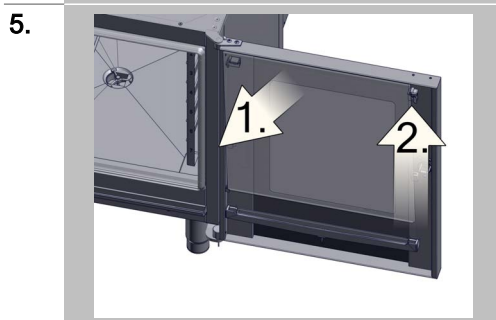

- Pivot (1) the interior glass panel slightly away from the top bracket.
- Lift (2) the interior glass panel out of the door drip tray and place it down safely.

Fitting the interior glass panel

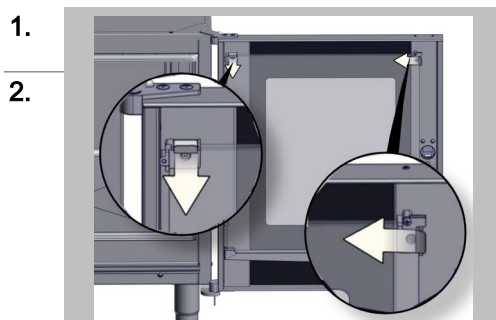

To fit the interior glass panel, follow the steps for removal in the reverse order.

Check that the spring clips are securing the interior glass panel again correctly at the top left and right, and that the catch on the top right bracket is closed. The appliance door cannot close until this is the case.

5.3.6 Removing and fitting the intermediate glass panel of the triple glass door

⚠ For your safety when using the combi oven

Before starting work, it is essential that you familiarize yourself with the rules and hazard warnings specified in the chapter 'For your safety on page 13' and in this instruction manual, and follow the instructions given there.

Prior knowledge required

You need to know these operations:

- Opening and closing the appliance door safely 33
- Removing and fitting the interior glass panel of the triple glass door 64

Materials required

Allen key, size 3 mm

Requirements

- The cooking chamber has cooled down to ambient temperature after its last use.
- Your hands are clean and dry so that you can grip the intermediate glass panel securely.
- The appliance door is open and the interior glass panel of the triple glass door has been removed.

Removing the intermediate glass panel

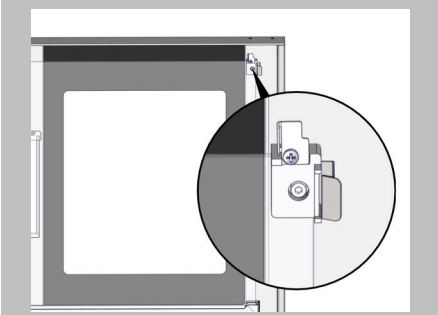
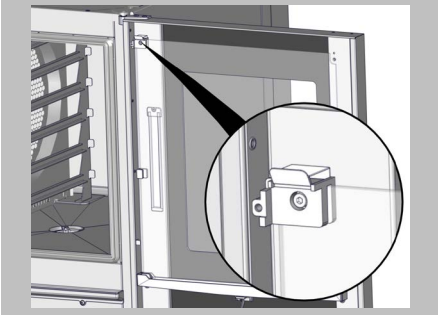
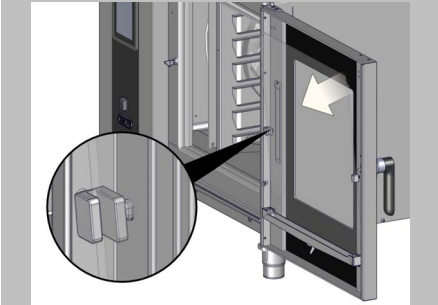
1. 
 - Unscrew the retaining screw in the top right bracket using the Allen key.
 - Pull the top right bracket away from the intermediate glass panel.
2. 
 - Hold the intermediate glass panel firmly from the top.
 - Unscrew the retaining screw in the top left bracket using the Allen key.
 - Pull the top left bracket away from the intermediate glass panel.
3. 

Pivot the top of the intermediate glass panel slightly away from the door; the spacers at the side are pulled slightly out of the door in the process.

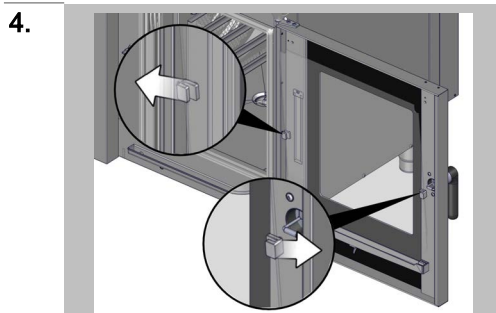

Slide the two spacers sideways away from the intermediate glass panel. The spacers stay fitted on the door.

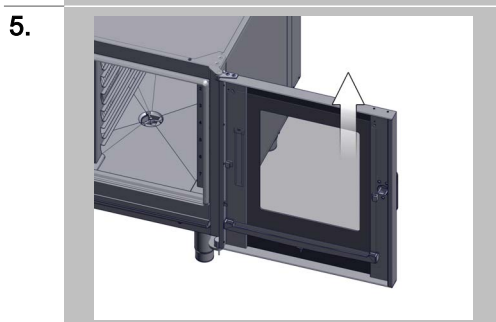

Lift the intermediate glass panel out of the door drip tray and place it down safely.

Fitting the intermediate glass panel

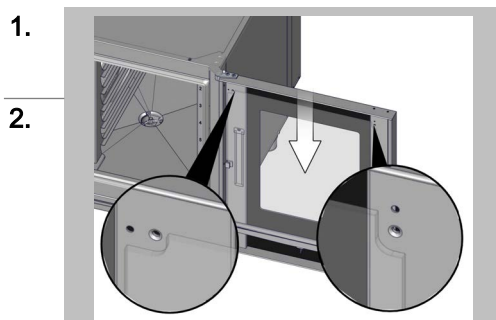

Make sure you fit the intermediate glass panel the correct way round. The two notches in the intermediate glass panel face upwards and have a different contour.

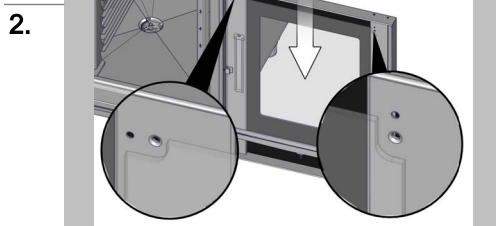

To fit the intermediate glass panel, follow the steps for removal in the reverse order.

6 Servicing procedures

6.1 Basic principles for servicing

6.1.1 Contact customer service

Required information

Please have the following appliance data to hand when contacting our customer service:

- Part number of your appliance (see 'Identifying your combi oven' on page 7)
- Serial number of your appliance (see 'Identifying your combi oven' on page 7)

Contact details for Convotherm Germany

Convotherm Elektrogeräte GmbH
 Welbilt
 Talstraße 35
 82436 Eglfing
 Germany

Head office	
Phone	(+49) (0) 8847 67 - 0
Fax	(+49) (0) 8847 414
e-mail	info@convotherm.de
Internet	www.convotherm.com www.welbilt.com
Application support	
Hotline	(+49) (0) 8847 67 - 899
e-mail	convotherm.chefshotline@welbilt.com
Sales	
Phone (appliances/accessories)	(+49) (0) 8847 67 - 890
e-mail (appliances/accessories)	convotherm.order@welbilt.com
Phone (spare parts)	(+49) (0) 8847 67 - 821 (+49) (0) 8847 67 - 822 (+49) (0) 8847 67 - 827
e-mail (spare parts)	convotherm.spares@welbilt.com
Customer service	
Technical hotline (office hours)	(+49) (0) 8847 67 - 541
Technical Hotline (outside office hours)	(+49) (0) 175 405 41 09
e-mail	convotherm.service@welbilt.com
Documents download centre (spare-parts lists, circuit diagrams, service manuals, brochures, instructions)	www.convotherm.com

Contact details for Welbilt Asia

SEA Region	
Welbilt Asia Pacific	627A Aljunied Road, #05-03 Biztech Centre, Singapore 389842
Phone	+65 6420 0800
e-mail	info.apac@welbilt.com
CHINA	
Welbilt Shanghai	255 Yangzhai Road, Bldg 5, 5A, Changning District, Shanghai, China 200051
Phone	+86 21 61526100
JAPAN	
Welbilt Japan	Hibiya Eisen Building 707, 1-6-3 Yurakucho, Chiyoda-ku, Tokyo 100-0006
Phone	+81 03 6550 8234
Fax	+81 03 6550 8235
INDIA	
Welbilt Foodservice India	3rd Floor, Plot no. 117 , Sector 44. Gurugram -122003 Haryana, India
Phone	+91 124 4763700
e-mail	sales.india@welbilt.com

6.1.2 Warranty information

Warranty information

Warranty claims involving your combi oven will only be honoured if the unit has been installed by a qualified Service Engineer from an authorized service company in accordance with the instructions in the installation manual. The manufacturer must be in receipt of a fully completed checklist, enclosed with the appliance, before a warranty claim can be dealt with.

The warranty does not cover damage resulting from improper setup, installation, use, cleaning, use of cleaning agents, servicing, repair or descaling.

To extend the spare parts warranty to 2 years, you need to register the appliance on the manufacturer's homepage (www.convotherm.de) after installing the appliance.

6.1.3 Servicing schedule

Rules for servicing the appliance

The combi oven must be serviced regularly to ensure it can operate safely and reliably. Servicing includes maintenance tasks that can be performed by the user as well as maintenance work that must be carried out by a qualified Service Engineer from an approved customer service office.

Whenever servicing is performed:

- The appliance must be cleaned after any servicing work.

Servicing tasks that the user can perform

What must be serviced?	When?	Parts required
Replacing the hygienic plug-in gasket	If the hygienic plug-in gasket is cracked or greasy	As listed in the spare parts list: 1 hygienic plug-in gasket
Keeping the core temperature probe (option) in working order	Perform a weekly test in boiling water, checking the reading on the temperature display	-

Servicing tasks that Customer services must perform

What must be serviced?	How often / When?
General servicing	Annually
Water treatment must be adjusted correctly	If there is a white deposit in the cooking chamber

6.2 Troubleshooting

6.2.1 Error codes

Errors and required responses

The following table lists the errors that you may be able to resolve yourself. If the combi oven continues to display the error after you have tried to resolve it, please contact customer service. Always contact customer service for help if any error messages appear that are not listed here.

Error no.	Description of error	Required response
E01.x	Low water	Switch on water supply / both water supplies
E02	Temp. electrical area too high	<ul style="list-style-type: none"> ▪ Clean the fan grille located outside at the bottom of the appliance ▪ Clear air intake in base of appliance
E10	Error from water filter	Replace the water treatment cartridge
E58.0	Error from cleaning-agent dispensing pump	<ul style="list-style-type: none"> ▪ Fill canister with the correct cleaning agent and restart the appliance ▪ Repeat as necessary until the tubes are filled with cleaning agent
E59.0	Error from rinse-aid dispensing pump	<ul style="list-style-type: none"> ▪ Fill canister with rinse aid and restart the appliance ▪ Repeat as necessary until the tubes are filled with rinse aid
E81.0	Cooking mode error	Download cooking profile again
E99	Communication lost	Unplug the appliance for approx. 10 seconds then restart
E99.9	Initialization error	Unplug the appliance for approx. 10 seconds then restart

6.2.2 Emergency mode

Operating the combi oven in emergency mode

Your combi oven has an emergency mode that lets you continue to use it when it has a fault that cannot be resolved quickly.

This gives you continued but limited use of the appliance even though it has a fault.

Always notify your customer service office however.

Requirements

- The appliance is in emergency mode.
- An audible signal is given.
- An error code is shown in the display.

Operating the appliance in emergency mode

1.

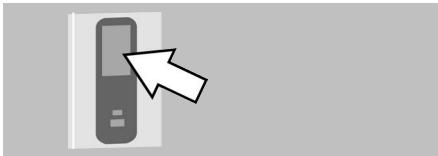

Confirm the displayed error and start a cooking profile or a cleaning profile that is based on an available operating mode.

Limitations

- Cooking times may be longer and uneven cooking may result. So pay particular attention to the cooking operation and the cooked condition of your product.
- Water consumption may increase.
- Fully automatic oven cleaning may not be possible or only have limited functions available.
- The core temperature probe (option) may not work.
- Only those functions can be selected that will not be impaired by the active fault in question.

Functions available in emergency mode

The following table lists the errors under which the appliance can still work, albeit with limitations, in emergency mode when the error cannot be resolved quickly.

Error no.	Functions available in emergency mode	Limitations / Action
E00.0	All functions	Previous fault no longer exists
E01.x	Convection at up to 140 °C	Cleaning not possible
E10	All functions	-
E21.3	Steam at exactly 100 °C	Cleaning not possible
E22.1.x E22.2.x E22.3.x E22.4.x E22.5.x	All functions, EXCEPT: ▪ Core temperature probe	No functions that use the core temperature probe
E24.1 E24.3	Convection	Cleaning not possible
E25.1 E25.3	Convection at up to 140 °C	<ul style="list-style-type: none"> ▪ Increased water consumption through constant cooling of the collector box ▪ Cleaning not possible

Error no.	Functions available in emergency mode	Limitations / Action
E27.1 E27.3 E27.4	All functions	-
E30.1 E30.3	All functions, EXCEPT: ▪ Fully automatic oven cleaning	Only affects the cleaning process
E35.0	All functions, EXCEPT: ▪ Fully automatic oven cleaning	Affects the cleaning process and Crisp&Tasty
E58.0	All functions	Error only affects fully automatic oven cleaning using connected canisters
E59.0	All functions	Error only affects fully automatic oven cleaning using connected canisters
E61.0	All functions, EXCEPT: ▪ Fully automatic oven cleaning	Only affects the cleaning process
E62.0	All functions, EXCEPT: ▪ Fully automatic oven cleaning	Only affects the cleaning process
E63.0	Convection	Cleaning not possible
E72.x	All functions	-
E73.1	All functions	-
E91.x	All functions	-
E92.x	All functions	-
E200.x	All functions	-

6.2.3 Problems during use

Problems with the food being cooked

Problem	Possible cause	Required response
Uneven browning	Suction panel not closed correctly	See 'Removing and fitting the suction panel' on page 61
	Cooking chamber not preheated	Preheat the cooking chamber
	Oven temperature too high	Select a lower oven temperature and extend the cooking time
	Heater has failed completely or part of heater is faulty	Contact customer service

Problems with the appliance

Problem	Possible cause	Required response
Appliance does not respond to any input for 10 - 20 seconds	Software crash	Press ON/OFF for 5 seconds or disconnect the appliance from the mains supply for 5 seconds
The 'kitchenconnect®' Internet icon is white	No active Internet connection	Check that the network cable is inserted securely in the network socket.
Water runs out underneath the appliance when closing the appliance door	Whatever the cause	CAUTION! Contamination hazard Discard any food that has come into contact with this water.
	Blockage or constriction in the drain pipe or wastewater system	<ul style="list-style-type: none"> ▪ Check the drain pipe and customer's wastewater system and clean out if necessary ▪ Fit funnel waste trap if necessary
	Permanent drain connection on appliances equipped with fully automatic oven cleaning	
	Air vent blocked or covered	Remove obstruction
	Appliance drain clogged	Clean appliance drain
Water standing in cooking chamber	Oven drain is blocked	Rinse out oven drain
Steam is escaping from the ventilation port on top of the appliance	Faulty valve in ventilation port	WARNING Risk of scalding from hot steam and vapour Contact customer service

Problems with cleaning

Problem	Possible cause	Required response
Black marks in the cooking chamber	Incorrect cleaning agent	Use ConvoClean forte for fully automatic oven cleaning using connected canisters
	Water too hard	Adjust water hardness; see 'Technical data' in the installation manual
Poor cleaning result	Incorrect soiling level set	Select a higher cleaning level
	Incorrect cleaning agent used	Use ConvoClean forte or ConvoClean new for fully automatic oven cleaning using connected canisters

What to do in the event of a power failure

During a cooking operation:

- After a power failure, the cooking process resumes automatically if the downtime is less than 5min. Any build-up of bacteria in the food is prevented.

During a fully automatic cleaning operation:

- After a power failure, the cleaning process resumes automatically in a defined state. No cleaning product mix is left in the cooking chamber.

6.3 Servicing tasks

6.3.1 Replacing the hygienic plug-in gasket

▲ For your safety when using the combi oven

Before starting work, it is essential that you familiarize yourself with the rules and hazard warnings specified in the chapter 'For your safety on page 13' and in this instruction manual, and follow the instructions given there.

Prior knowledge required

You need to know these operations:

- Opening and closing the appliance door safely 33
- Removing and fitting the hygienic plug-in gasket 63

Spare parts contents

Spare part required as listed in the spare parts list:

- 1 hygienic plug-in gasket

Requirements

- The cooking chamber has cooled down to < 60 °C after its last use.
- The appliance door is open.
- The newly supplied gasket has been checked for damage and is intact.

Replacing the hygienic plug-in gasket

To remove the old hygienic plug-in gasket and to fit the new hygienic plug-in gasket, follow the instructions given in 'Removing and fitting the hygienic plug-in gasket' on page 63.

Engineered in Germany

Combi oven Cmx eT 6.10 ES / Cmx eT 10.10 ES

Serial no.

Item no.

Order no.

Additional technical documentation can be found in the download center at :
www.convotherm.com



Welbilt offers fully-integrated kitchen systems and our products are backed by KitchenCare® aftermarket parts and service. Welbilt's portfolio of award-winning brands includes **Cleveland™**, **Convotherm®**, **Crem®**, **Delfeld®**, **fit-kitchenSM**, **Frymaster®**, **Garland®**, **Kolpak®**, **Lincoln™**, **Manitowoc®**, **Merco®**, **Merrychef®** and **Multiplex®**.

Bringing innovation to the table • welbilt.com