

SEL CO SK 4

NUMERICAL CONTROL
BEAM SAW

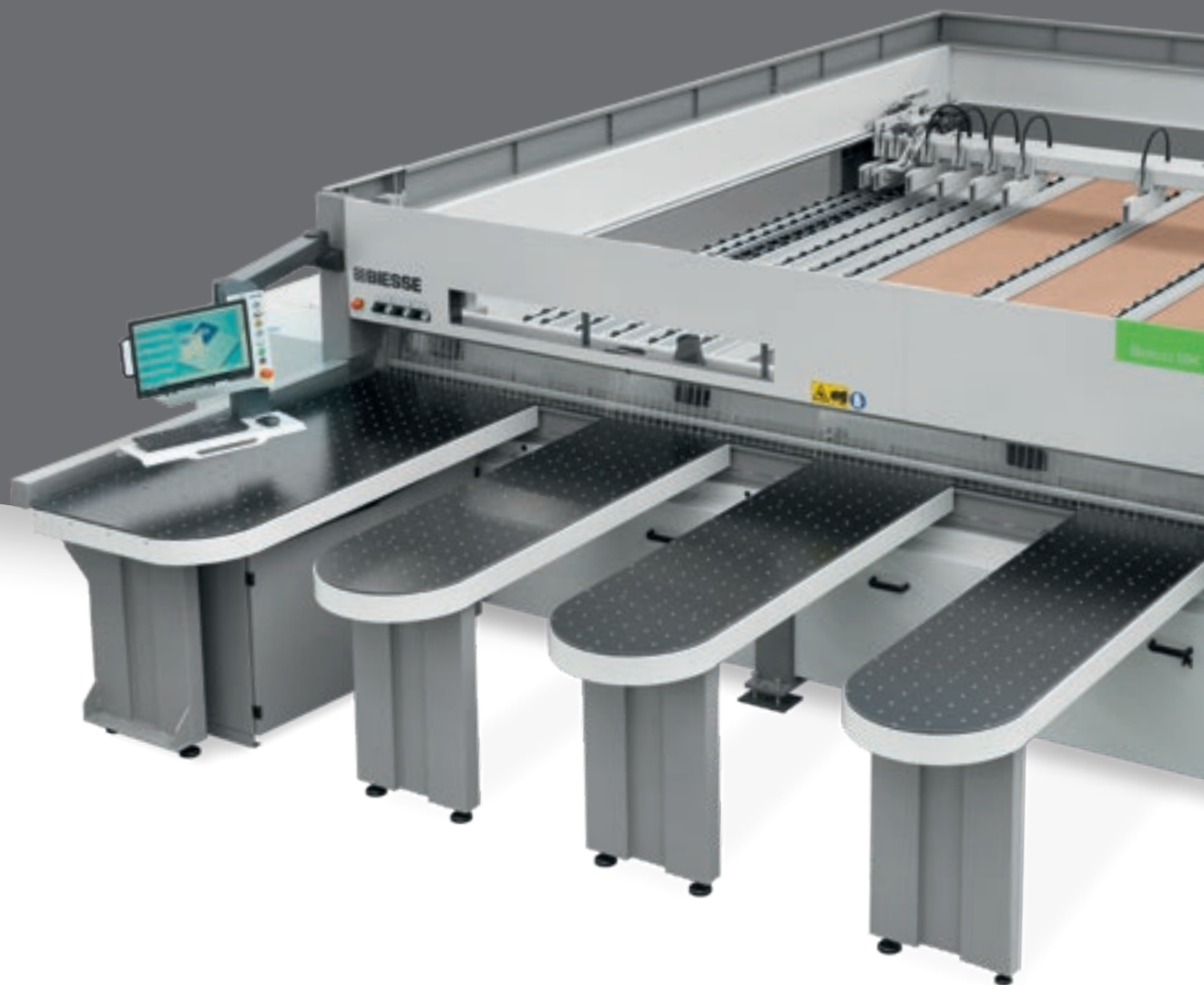

INTUITIVE CUTTING-EDGE TECHNOLOGY WITH REDUCED FOOTPRINT



THE MARKET EXPECTS

a change in manufacturing processes, enabling companies to **accept the largest possible number of orders**. This is coupled with the need to maintain high quality standards whilst offering product customisation **with quick and defined delivery times**.

BIESSE MEETS

these requirements with **technological solutions** which enhance and support technical expertise as well as process and material knowledge. **Selco SK 4** is the range of cutting centres designed to satisfy the needs of small to medium-sized enterprises. It is easy to use, has advanced technical solutions and features great standard equipment. The Selco SK 4 has become the reference point in its sector.



SELCO SK 4

- **BEST PERFORMANCE IN ITS CATEGORY**
- **EASY AND QUICK TO ADJUST FOR REDUCED CYCLE TIMES**
- **LEAN, EFFICIENT PRODUCTION FLOWS**
- **PRODUCTION INCREASE OF UP TO 25%**
- **EASY TO USE, WITH OPTIMISED MACHINING OPERATIONS**

CUTTING QUALITY

Robust, balanced structure ensuring maximum stability. Specially-designed technologies to guarantee precision and rigidity.



The base of the machine is constructed from solid steel, supported by robust legs which guarantee perfect stability. The carriage rails ensure the machine remains perfectly parallel and straight, maintaining optimal tool-holder carriage balance.

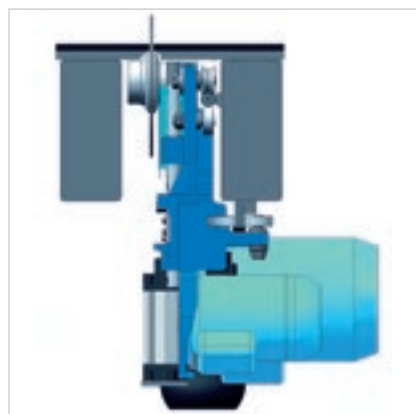

The blade is not subject to any vibration, thanks to the **upper guide**, positioned next to the blade-holder spindle.

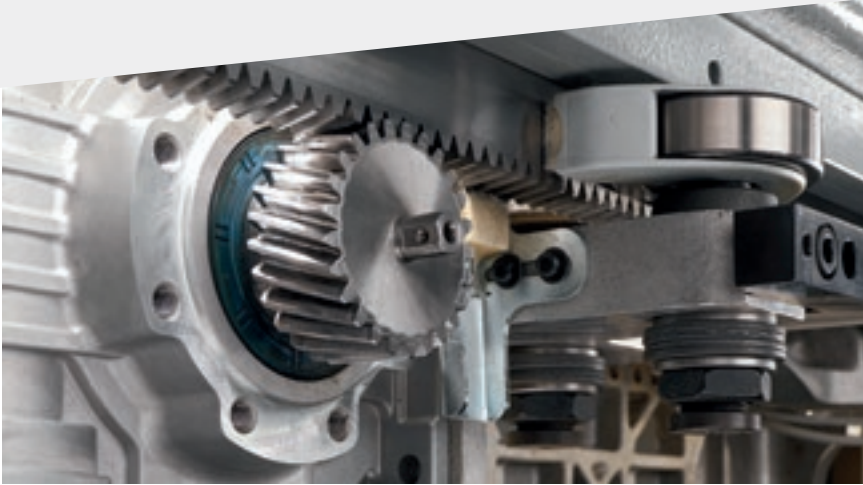

The perfectly linear movement of the tool holder carriage is achieved through a helical rack and pinion system and is driven by a brush-less servomotor.

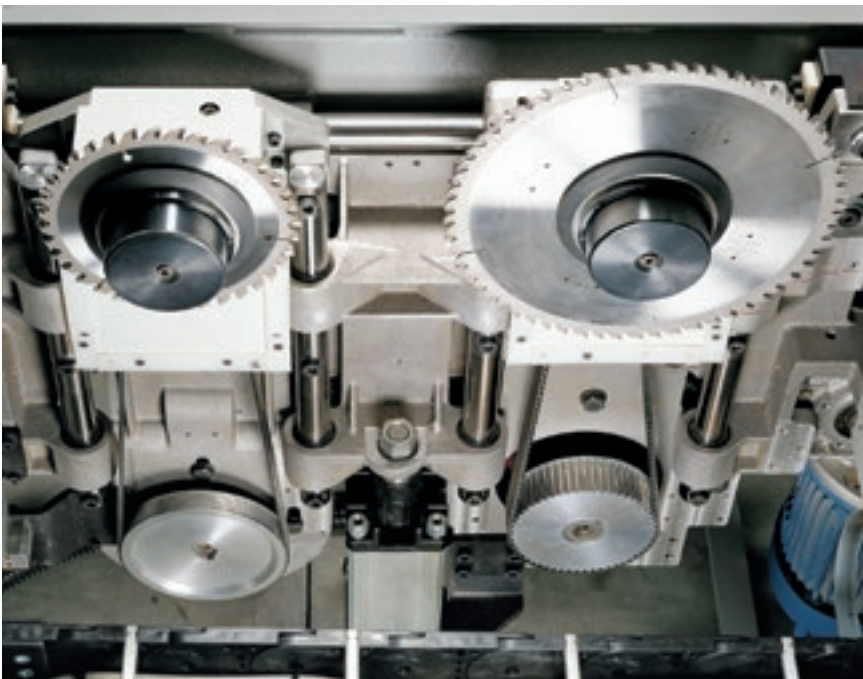

The superior cutting quality is achieved through independent rise and fall movements of the main blade and the scoring blade.

The **projection of the main blade** is automatically adjusted by the numerical control according to the thickness of the book to be cut, obtaining the best quality cut under any working conditions. On the Selco SK 450 K1, the automatic blade projection is regulated on two levels.



BEST PERFORMANCE IN ITS CATEGORY

Unique technical solutions on the market, to satisfy even the most rigorous production demands, in terms of both precision and flexibility.



The **presser** boasts a single-element structure which guarantees consistent, controlled pressure on the book of panels to be cut. The opening is automatically optimised according to the thickness of the book of panels, in order to achieve the best cut quality and to reduce cycle times.



Fast, accurate positioning of the panels for optimum cutting precision, thanks to the robust pusher carriage activated by a brushless motor. The slide surface below the pushing device is fitted with independent rollers to avoid making any marks on panels with a delicate surface.



The self-levelling, independent grippers ensure that the panels are firmly locked in place, and allow for the full expulsion of sectioned stacks from the cutting line.

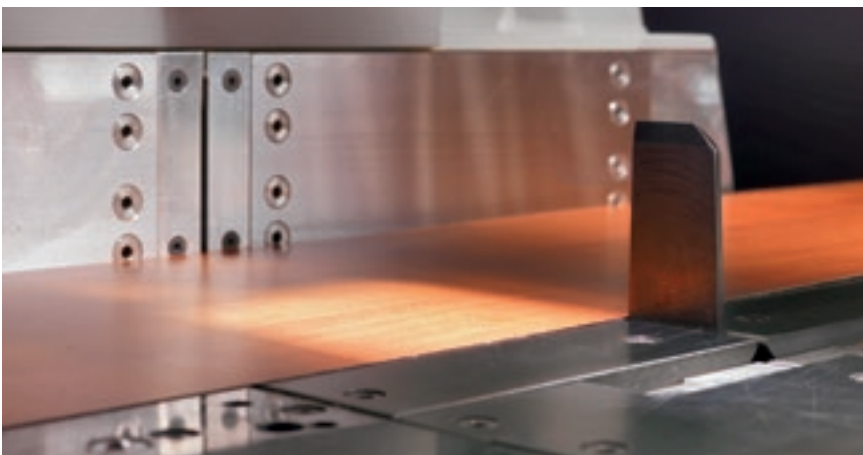

Perfect alignment of very thin and/or flexible panels, minimising cycle times thanks to the **side alignment stop** integrated in the blade carriage.



FAST AND EASY ADJUSTMENT FOR REDUCED CYCLE TIMES



The **Quick change** system, patented by Biesse, is the quickest, safest and most ergonomic device for replacing blades without using specific tools.



Fast, accurate setting of the scoring and main blades, using **Digiset system**. The system also stores the information for each set of blades, ensuring repeatable and accurate alignment every time.

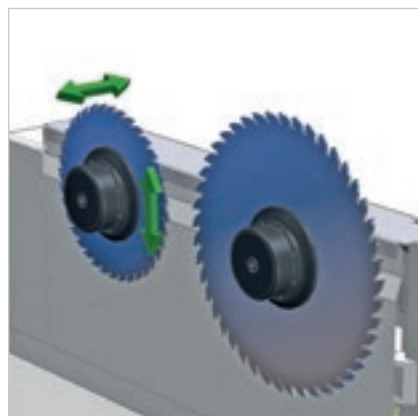

REDUCED PANEL LOADING AND UNLOADING TIMES

On request special solutions are available for the movement of packs and to permit the loading and unloading of panels.



The compact, integrated **lifting table** allows for packs of panels of up to 630 mm to be loaded directly onto the steel profiles. The lifting table can also be installed as an option.



The **grippers** automatically pick up the required amount of panels according to the working programme underway, increasing the efficiency and safety of the beam saw without affecting the compact overall dimensions

TWIN PUSHER

TWO BEAM SAWS IN ONE

The Twin Pusher, an exclusive patent for all Biesse beam saws, consists of two complementary pushing devices. An additional stop allows independent cutting of strips of up to 650 mm wide.

Increased productivity by up to 25%, optimum management of production efficiencies and a ROI within the first year.

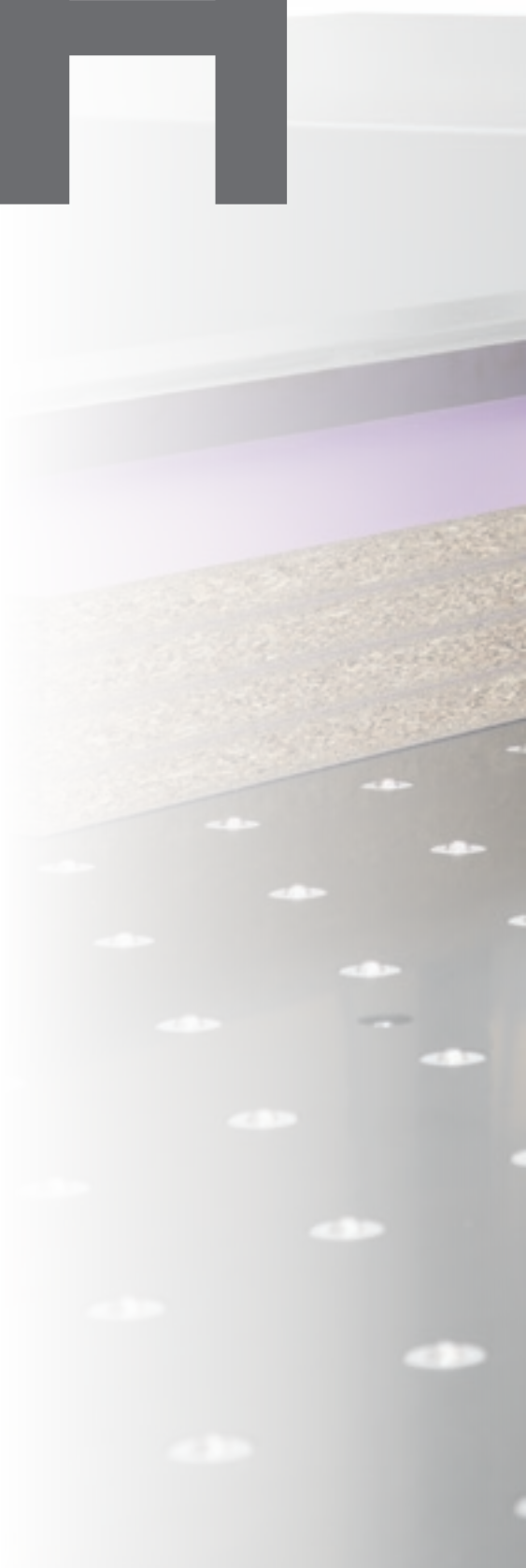

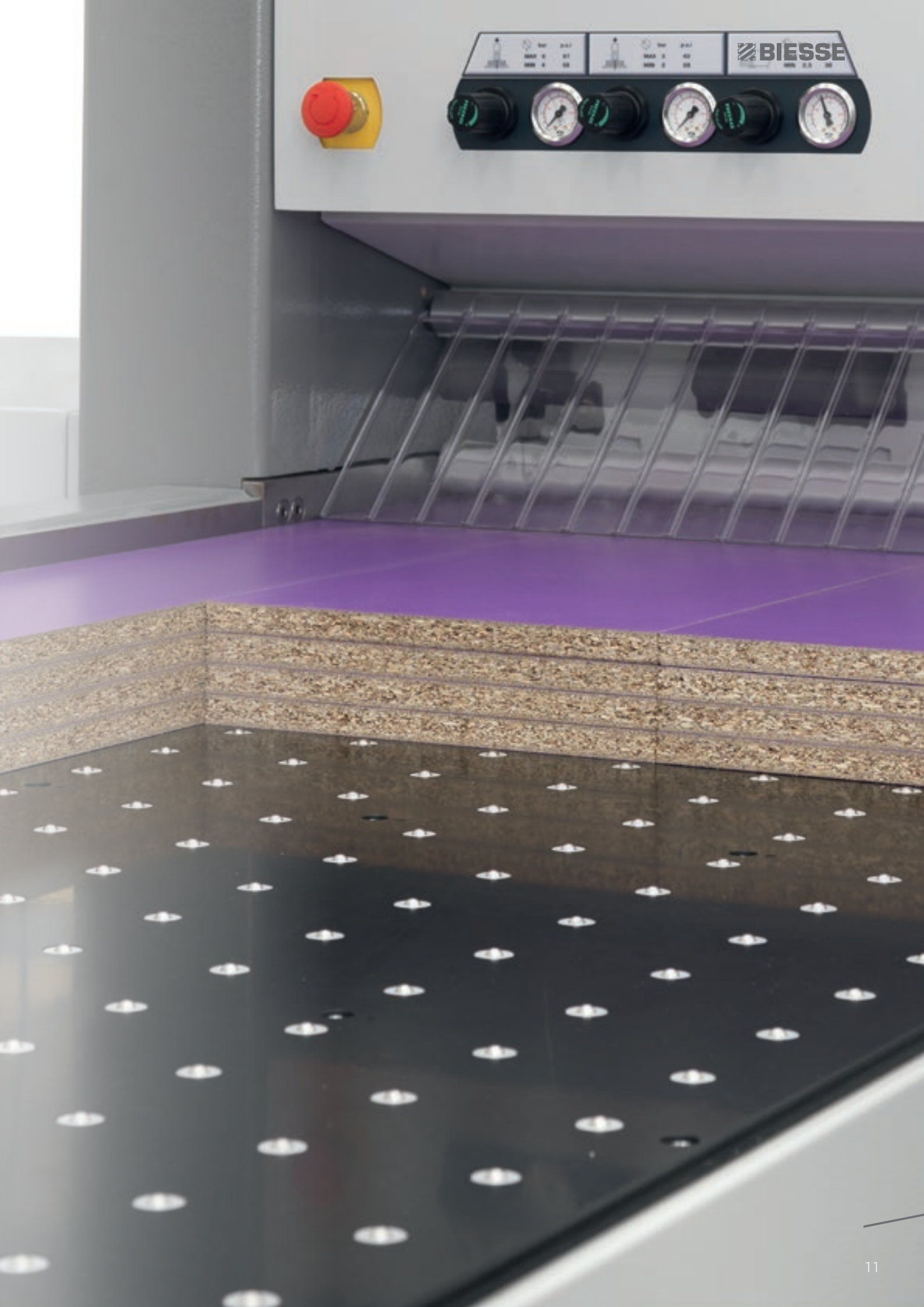

BIESSE

PRODUCTIVITY INCREASE OF UP TO 25%

Two cutting stations
on a single beam saw.



The **Twin Pusher** system offers an additional pushing device consisting of two fixed collets. It permits simultaneous cutting, which drastically reduces the cycle time.



Differentiated cross cut.



Differentiated cross cut for narrow strips.

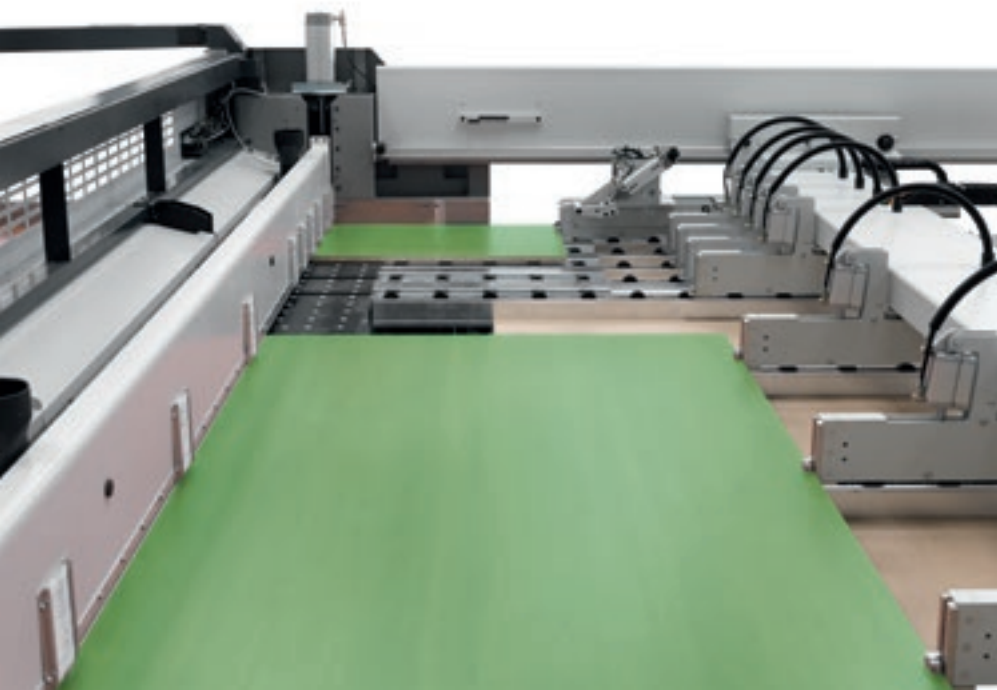

Rip and cross-cuts are performed at the same time. An additional stop allows independent cutting of strips of up to 650 mm wide.

TECHNOLOGICAL SOLUTIONS FOR EVERY MACHINING NEED



System for the automatic execution of grooves, the width of which can be programmed via the numerical control. The groove depth can be adjusted manually from the outside of the machine and with the blades moving.



Excellent product quality, thanks to the air cushioned working surface, which protects delicate materials. In addition, this characteristic ensures the surface next to the blade is kept constantly clean.

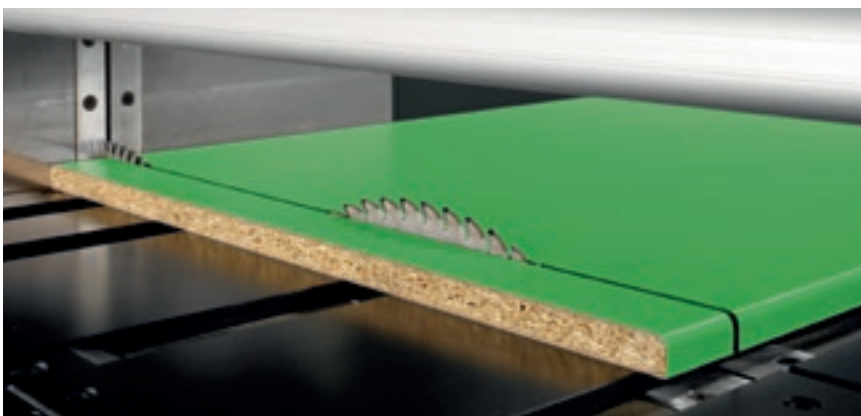

PFS function for making cuts on soft and post-formed panels. A special NC program that ensures the perfect finish of both the entrance point and the exit profile, preventing any splintering of fragile, delicate materials (patented).

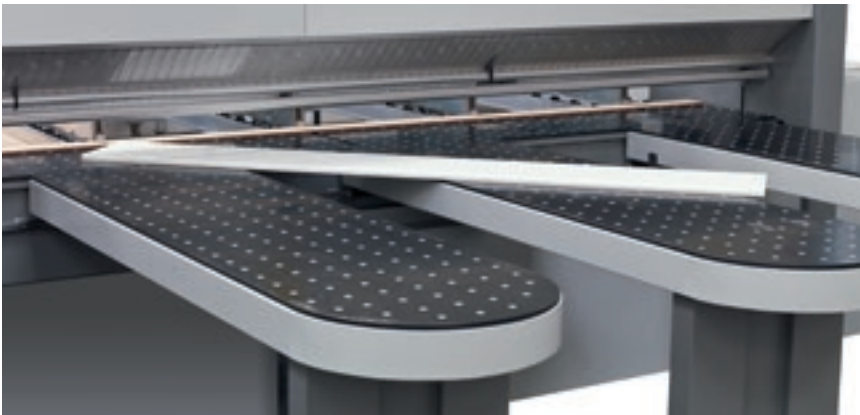

Automatic device for making angled cuts.



Grippers with specific stops for processing books of laminated materials with protruding edges.

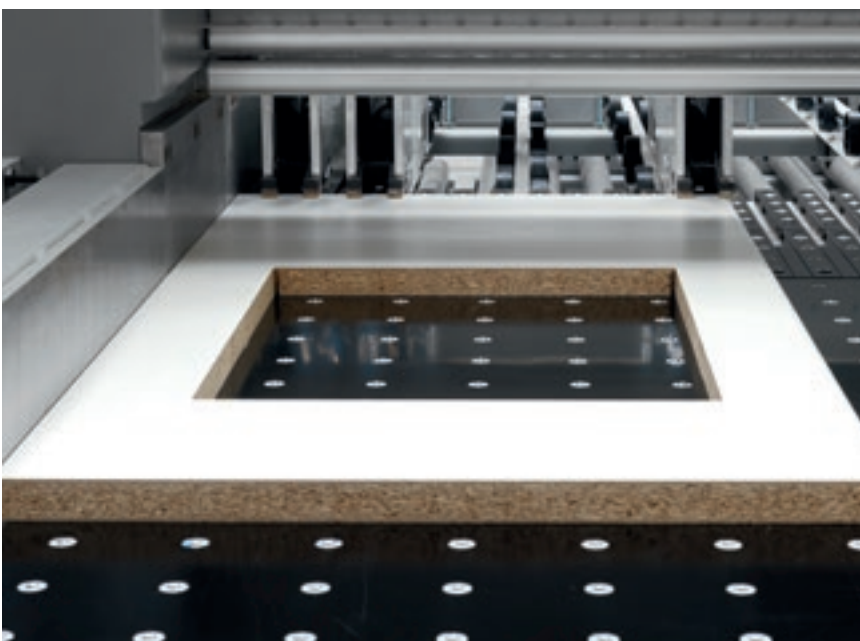

Software for making window cuts on panels. The layouts can be stored on the numerical control.

PRODUCTION



COMPETITIVE CUSTOMISATION

Made-to-measure turnkey factories, plus the integration of Biesse Group solutions with complementary software and machinery, with over 1000 systems installed worldwide.

Biesse Systems is a team of highly trained engineers for large scale production processes. Biesse Systems offers integrated cells and systems that are capable of maximising customer competitiveness by combining mass production techniques with a high degree of customisation to meet customers' exact requirements.



EASY TO USE, WITH OPTIMISED MACHINING OPERATIONS

The OSI (Open Selco Interface) numerical control guarantees the management of the execution of cutting patterns, and optimizes all movements relative to controlled axis (i.e. Pusher and Saw Carriage, pressure beam, blade height). It ensures the blade protrudes from the book to the correct degree during sectioning, and calculates the most suitable cutting speed on the basis of the book height and trim cut width. It helps ensure the best cutting quality at all times.

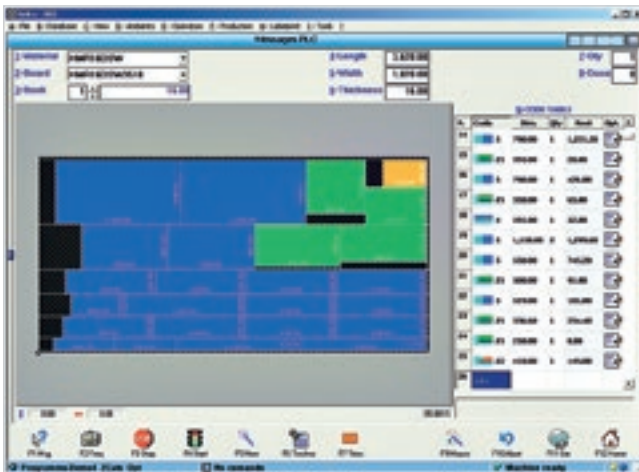

Easy cutting pattern programming.



Graphic simulation in real time, with messages and information for the operator.

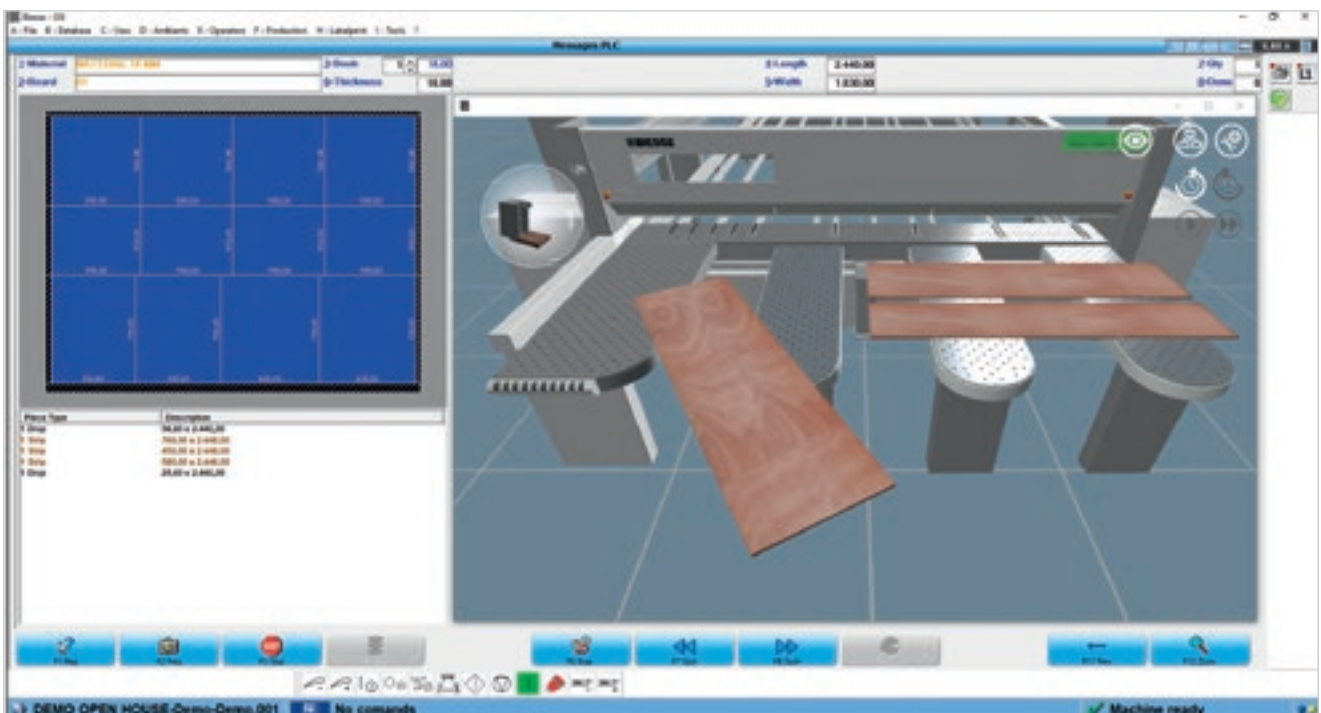



Interactive program for the quick, easy execution of cuts and grooves, even on recycled panels.



An effective diagnosis and troubleshooting program provides complete information (photos and text) to ensure that any problems are quickly resolved.

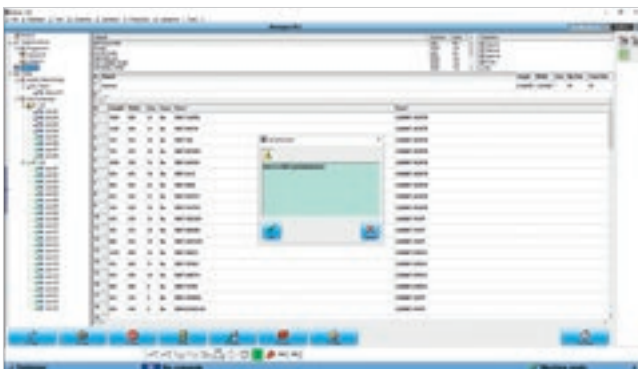

Quick Opti
Simple, intuitive software for optimising the cutting patterns directly on the machine.



Barcode scanner
Device for automatically accessing machine operation patterns, for automated management of the remaining reusable cut material.

Labelling
A special software creates individual labels and prints them in real time, on the machine.



TECHNICAL SPECIFICATIONS

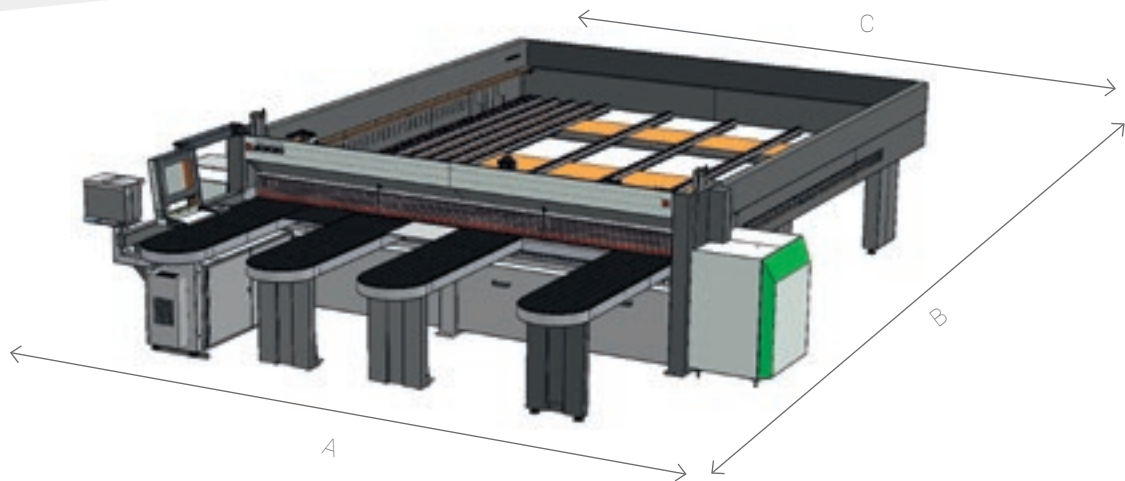

SELCO SK 4

	3200X3200	3800X3200	3800X3800	4300X4400
	mm/inch	mm/inch	mm/inch	mm/inch
A	5240/206	5840/230	5840/230	6340/250
B	6520/257	6520/257	7200/283	7670/302
C	3640/143	4240/167	4240/167	4740/187

		450 K1 / 450 K2	470 K1 / 470 K2
Maximum blade protrusion	mm/inch	75/2.9	90/3.5
Main blade motor	kW	7.5	11
Engraver blade motor	kW	2.2	
Blade carriage transfer		brushless	
Blade carriage speed	m/min - ft/min	1-120 / 3.2-394	
Pushing device transfer		brushless	
Pushing device speed	m/min - ft/min	60 - 197	

The technical specifications and drawings are non-binding. Some photos may show machines equipped with optional features. Biesse Spa reserves the right to carry out modifications without prior notice.

Weighted surface noise level A (Lp_{fA}) dB(A) 83,95. Weighted noise level A (L_{wA}) dB(A) 104,95. Uncertainty of measurement K = 4 dB (A).

The measurement was carried out in compliance with UNI EN ISO 3746, UNI EN ISO 11202 and subsequent modifications. The noise levels indicated are output levels and do not necessarily represent safe operational levels. Even though there is a relation between emission levels and exposure levels, this cannot be used reliably to establish whether or not further precautions are necessary. The factors determining the actual noise levels to which the operative personnel are exposed to include the length of exposure, the characteristics of the work environment, other emission sources, i.e. the number of machines and machining operations in the vicinity. In any case, this information will help the machine user to better assess the danger and risks involved.

MANAGING PRODUCTION IN A SIMPLE, USER-FRIENDLY MANNER

SMART CONNECTION
Powered by Retuner



SMARTCONNECTION IS A SOFTWARE PACKAGE FOR MANAGING JOB ORDERS WITHIN THE COMPANY - FROM THE GENERATION PHASE TO SCHEDULING AND PRODUCTION START-UP - IN JUST A FEW SIMPLE, INTUITIVE STEPS.

THANKS TO SMARTCONNECTION, PRODUCTION SITE MACHINES CAN BE LINKED UP TO TRANSFORM THE COMPANY INTO A 4.0 ENTITY..



SmartConnection is a web-based solution that can be used by any device.



i Biesse is extending SmartConnection across all geographical areas.
To check availability in your country, get in touch with your commercial contact.

SOFTWARE FOR THE SMART, ASSISTED MANAGEMENT OF CUTTING PATTERNS



B_OPTI IS THE SOFTWARE FOR OPTIMISING CUTTING PATTERNS, DEVELOPED ENTIRELY BY BIESSE.

BASED ON THE LIST OF PIECES TO BE PRODUCED AND THE PANELS AVAILABLE, IT CAN CALCULATE THE BEST SOLUTION TO MINIMISE MATERIAL CONSUMPTION, SECTIONING TIMES AND PRODUCTION COSTS.

- Simple, user-friendly interface.
- Excellent reliability of the calculation algorithms for production batches in small and large companies.
- Automatic import of the cutting list generated by the software for the design of furniture items and/or ERP management systems.





CUSTOMER CARE IS WHO WE ARE

SERVICES is a new experience for our customers, to offer not just excellent technology but the added value of an increasingly direct connection with the company, the professionals who work there and the experience they embody.



ADVANCED DIAGNOSTICS

Digital channels for remote interaction online 24/7. Always ready to intervene on-site seven days a week.



A WORLDWIDE NETWORK

39 branch offices, over 300 certified agents, retailers in 120 countries, and spare parts warehouses in America, Europe and the Far East.



SPARE PARTS AVAILABLE IMMEDIATELY

Identification, shipping and delivery of spare parts for every need.



EVOLVED TRAINING OPPORTUNITIES

Lots of on-site, online and classroom training modules for personalised growth.



VALUABLE SERVICES

A wide range of services and software packages to help our customers achieve continuous improvements in performance.

AN EXCELLENT LEVEL OF SERVICE

+550

HIGHLY SPECIALISED
TECHNICIANS AROUND
THE WORLD, READY TO HELP
CUSTOMERS WITH EVERY
NEED

90%

OF MACHINE DOWN CASES
WITH RESPONSE TIME
UNDER 1 HOUR

+100

EXPERTS IN DIRECT
CONTACT THROUGH
REMOTE CONNECTIONS
AND TELESERVICE

92%

OF SPARE PARTS ORDERS
FOR MACHINE DOWNTIME
PROCESSED WITHIN 24
HOURS

+50.000

ITEMS IN STOCK IN THE
SPARE PARTS WAREHOUSES

+5.000

PREVENTIVE MAINTENANCE
VISITS

80%

OF SUPPORT REQUESTS
SOLVED ONLINE

96%

OF SPARE PARTS ORDERS
DELIVERED IN FULL ON TIME

88%

OF CASES SOLVED WITH
THE FIRST ON-SITE VISIT

MADE WITH BIESSE

INCREASING COMPETITIVENESS WITH SOFTWARE

Artinvest is a 20 years old company and one of the leading company in Serbian market in selling material for furniture production and at the same time finished furniture.

We have ten shops dislocated from the central workshop; customers come to our shop, they have some ideas or some specification of elements and fittings, they can say 'I need this element which this color, this elements with this edgbanding', or we can even help him if is not familiar with that kind of business, so they can produce alone their own furniture.

Then we use Optiplanning, a Biesse's program for optimization of cutting, we collect different orders from customers and put it automatically in the system here in the headquarter of our company, and then we put it in production. We need to finish everything,

to produce the elements and then we need to deliver them to customers without any mistakes and right on time.

"Without the help of software we would be blind: we cannot do anything"
Sasa Kostic, General Manager.

The Whole system prepares the boards for the next cutting with the look ahead function or during the night, and cutting is automated on that way that the operator cannot make some mistakes or choose some other color. When we finish we're going on drilling on skipper machine or on Rover. With this software we have now, from Biesse, and with some other software we want to integrate together with your software, I think that our advantage in comparison with the competition will go on some higher level with all of this".

"When we started to think about this investment and we recognized that we need something like this, we contacted five biggest producers in Europe. There are many elements if you want to make some decision like this: trust, price, quality of the equipment, even delivery, and very important after sales service. Biesse really listened to us, we know that Biesse have service in Serbia with many technicians, and it is very important for us to have really good support in after sales. In this few months after installation we had really good support from Biesse, machines are working properly and everything is ok and I can say that we're satisfied with our choice".

Founded in Italy,
international native.

We are an international company that manufactures integrated lines and machines to process wood, glass, stone, plastic and composite materials and what will come next.

Thanks to our rooted competence nurtured by an ever-growing worldwide network, we support your business evolution – empowering your imagination.

Master of materials, since 1969.

We simplify your
manufacturing
process to make
the potential of
any material
shine.



Join the
Biesse world.

[biesse.com](https://www.biesse.com)



