

GLASS AND DISHWASHERS



ECOMAX 402/452/502 (incl. Australian 452-90/502)

INSTALLATION AND OPERATION INSTRUCTIONS

(original instructions)

IMPORTANT NOTES

USE IN ACCORDANCE WITH REGULATIONS

The machine is technical work equipment for express use in the work place.

The machine is exclusively to be used to wash ware such as plates, cups, glasses, cutlery, trays etc.

Do not use for electrically heated cooking and heat conservation appliances.

SAFETY:

Never hose down the machine.



**The “Attention” symbol is shown beside instructions that are essential for the safe operation of the machine.
Please read these passages thoroughly.**

LIABILITY:

Installations and repairs which are carried out by non-authorized technicians or the use of other than original spare parts, and any technical alterations to the machine, may affect the warranty set out in the standard conditions of sale.

MACHINE NOISE LEVEL:

The machine noise level is < 70 dB (A).

CONNECTING TENSIONS:

The machine described in this operation manual has following connecting tensions:
400 V/50 Hz/3 Ph/N/PE or 230 V/50 Hz/1 Ph/N/PE

GENERAL INFORMATION ON WASHING GLASSES AND CUTLERY:

The local supply water quality has a major impact on the wash and rinse result. A high content of minerals which are dissolved in the water during the drying process may become visible in the form of spots and streaks.

Authorised service personnel can determine the content of minerals by measuring the electrical conductivity. Values of less than 80 Microsiemens/cm indicate a low content of minerals. Higher contents need to be reduced below the critical level by demineralising the water using specific demineralisation cartridges or a reverse osmosis system.

Please contact your authorised service partner for support.

We recommend the use of specific glass racks. These racks hold the glasses in slightly inclined positions – this will improve the rinse efficiency.

To avoid unpleasant smelling glasses, specific chlorine-free detergent for glass washing should be used.

Before washing new glasses the first time with a commercial glass washer, intensive basic cleaning is mandatory to reduce the greasy film which is on most glasses for protection during production. If not, water drainage is impaired and streaks and spots may remain on glasses.

We recommend carrying out the basic cleaning manually in a sink (using gloves and a brush for cleaning) with a much higher chemical concentration of detergent (minimum 10 g of detergent per liter).

1. INSTALLATION	4
1.1. Location	4
1.2. Electrical connection.....	4
1.3. Water connection	5
1.4. Drain connection	5
2. CONTROLS	6
3. START-UP	7
3.1. Detergent	7
3.2. Rinse aid.....	7
3.3. Priming the suction hoses	8
3.4. Softener (optional)	9
4. OPERATION	10
4.1. Preparation	10
4.2. Run	11
5. SWITCH-OFF AND CLEANING THE MACHINE.....	12
5.1. Switch-off.....	12
5.2. Cleaning (daily).....	12
5.3. Cleaning (weekly).....	12
6. SETTINGS.....	13
6.1. Open setting menu	13
6.2. Adjustment of detergent dosage quantity.....	13
6.3. Adjustment of rinse aid dosage quantity	13
6.4. Adjustment of water hardness	14
7. FROST PREVENTION	15
8. MAINTENANCE	16
9. TROUBLESHOOTING GUIDE	17
9.1. Poor wash result	17
9.2. Other faults.....	18
9.3. Malfunctions.....	18

1. INSTALLATION

1.1. LOCATION



Low temperatures during transport/stocking may lead to damage of water containing components. Before installing the machine it should be exposed to normal room temperature (min. 15°C) for 24h.

- Rear wall clearance not required.
- Level machine by turning the feet.
- Distribute machine weight equally onto all feet

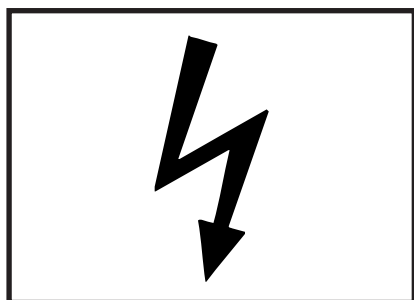

1.2. ELECTRICAL CONNECTION



Must be carried out by an authorized technician according to the local and national codes.

For Australia: in accordance with AS/NZS3500.1

- The electrical supply shall comply with the name-plate data.
- Line fuses and cable cross section shall comply with the requirements.

NOTE: A cut-off device shall be provided to connect the supply cord (isolating switch or accessible plug device). According to EN 60 335 the appliance must be connected to an equipotential conductor. The connecting screw (▽) is located beside the cable inlet.

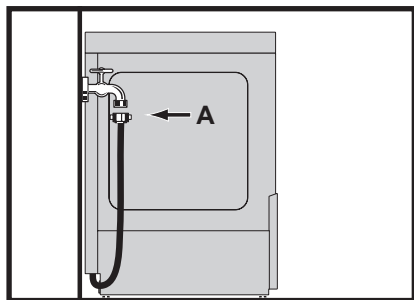

1.3. WATER CONNECTION



Must be carried out by an authorized technician according to the national and local codes.

The machine must be operated with potable water. For water with an extremely high mineral content an external demineralisation is strongly recommended

- Connect to warm water, if possible (max. 60°C).
- Water hardness:
 - Machines without softener: max. 3.75° Clark = 0.5 mmol/l.
 - Machines with softener: max. 37.5° Clark = 5.3 mmol/l.
- Line flow pressure
 - **with integrated rinse pressure pump:**
Line flow pressure 0,8 – 6 bar.
> 6 bar: pressure reducer valve necessary.
 - **without integrated rinse pressure pump:**
Line flow pressure: 3 – 6 bar.
< 3 bar: provide a rinse pump at site.
> 6 bar: pressure reducing valve necessary.
- Connect the union nut “A” (3/4”) of the water supply hose to the site shut off valve.
- Do not kink or cut the supply hose. If an extended supply hose is required, use one of the same specifications as the original.

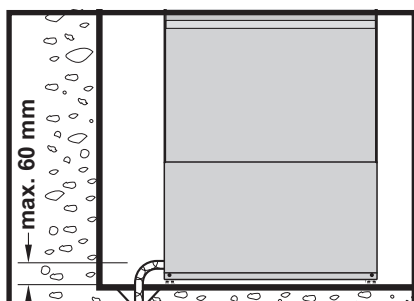

1.4. DRAIN CONNECTION

Machine without drain pump

- Ensure gravity drain.
- For these machine types, a floor drain is mandatory as the drain hose exits the machine at approx. 60 mm above floor level. Otherwise, residual water may remain in the tank and hose.
- Do not kink drain hose.

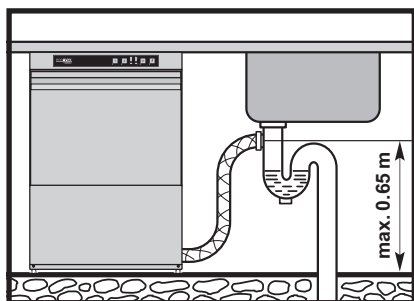

Machine with drain pump

- Connection between machine and site drain must not exceed max. height of 0,65 m.
- Do not place the drain hose loosely on the floor (the hose could be rubbed through). Fix it at site!
- Do not kink drain hose!

2. CONTROLS

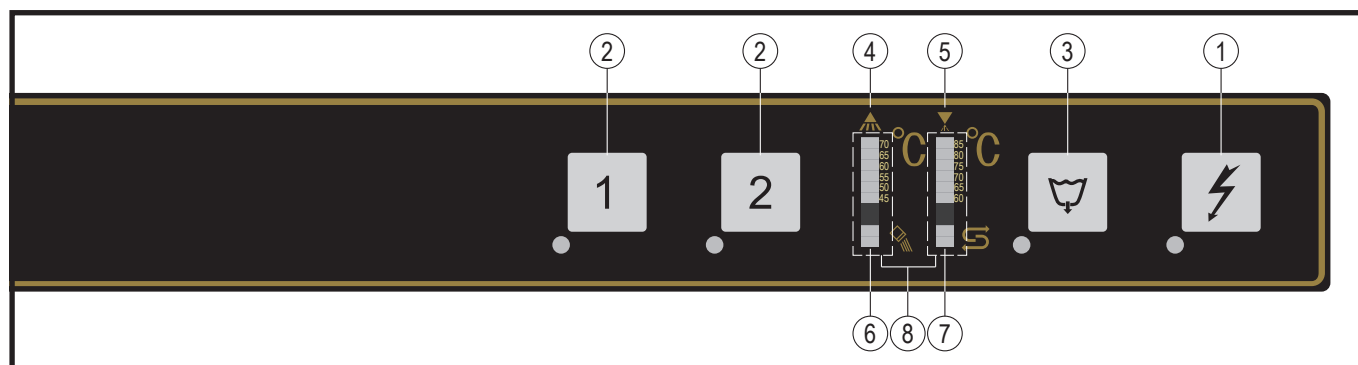

- ① Machine ON/STOP button
 Pushing this button switches the machine on.
 The LED lights up
 - flashing = Machine is filling and heating
 - permanent = Machine is ready
 In case of operating error or faults, it is possible to switch-off the machine immediately without the drain cycle, by pushing this button.
 After switch off, the machine is not voltage free!

- ② Program buttons
 By pushing these buttons, it is possible to select between short cycle (1) and standard cycle (2).
 The appropriate LED lights up.

- ③ Drain/OFF button
 By pushing and holding (3 seconds) this button, the self-cleaning cycle starts. At the end of the cycle, the machine switches off automatically. Machines with optional drain pump will drain the tank automatically.
 After switch off, the machine is not voltage free!

- ④ Temperature indication Wash
- ⑤ Temperature indication Rinse

- ⑥ Salt required
 Indicating the need for regeneration-salt to be added (only with built-in softener).

- ⑦ Regeneration indicator
 Softener regeneration active. The cycle running time can be extend.

- ⑧ Indicator for setting functions
 The individual LEDs are also used for various settings and special functions:

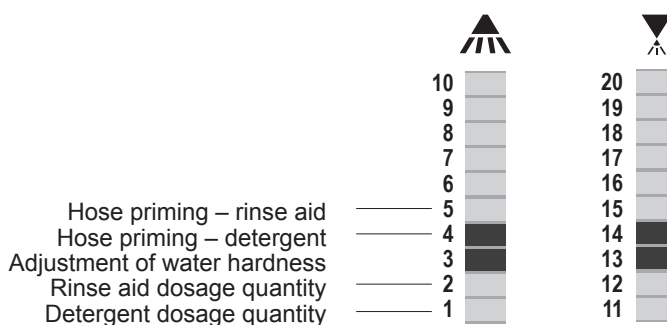

Left display: The LEDs 1 to 6 illuminate according to the selected function.

Right display: Indicates the adjusted value



Attention:

The maximum suction head of the dosing pumps is 1.5 m. Do not confuse the containers.
Use only detergent and rinse aid for commercial applications. Please pay attention to the manufacturer's safety instructions. Changing the chemical products requires to flush the supply hoses with water. The direct contact of different types of chemicals might lead to crystallization and as a consequence damage of the hoses. For the flushing just proceed similar as for the filling of the chemical hoses (see below).

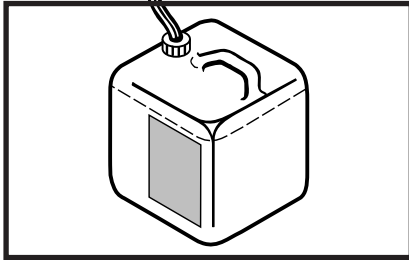

3.1. DETERGENT

- Do not use any acidic detergent products with the optional built-in detergent pump! (The ph-value has to be higher than 7)
- Place the suction hose into the external detergent container. Fill the suction hose according to chapter section 3.3.

3.2. RINSE AID

- Place the suction hose (blue marking) into the external rinse aid container. Fill the suction hose according to chapter section 3.3.

3.3. PRIMING THE SUCTION HOSES



ATTENTION:

The machine has to be switched off.

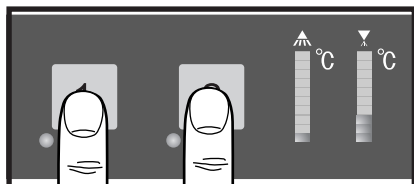

- Open the door.
- Push Program buttons ② simultaneously.
 - LEDs light up.
 - In display ⑧, the LEDs 1 and 11–20 illuminate (dependent on basic setting).

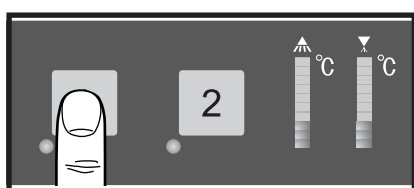

- Push Program button "1" repeatedly, until the display LED 3 lights up.
- Close the door.
- Push Program button "1" again.
 - In display ⑧ LED 4 lights up.

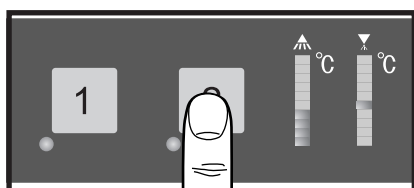

3.3.1. DETERGENT SUCTION HOSE

- Only with built in detergent pump.
- Push and hold Program button "2".
 - Hose will be filled.
 - moving light display ⑧ LEDs 15–18
- Releasing the button interrupts hose priming.

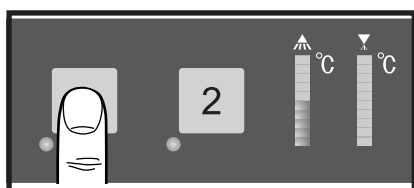

3.3.2. RINSE AID SUCTION HOSE

- Push Program button "1" again.
 - In display ⑧ LED 5 lights up.

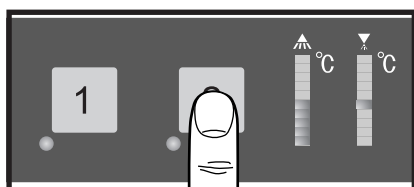

- Push and hold Program button "2".
 - hose will be filled.
 - moving light display ⑧, LEDs 15–18
- Releasing the button interrupts hose priming.
- Termination of hose priming: Open door or do not press any button for 30 seconds.

3.4. SOFTENER (OPTIONAL)

NOTE: For the first run, the softener has to be filled with regeneration salt and potable water.



Attention:
Filling the salt reservoir with cleaning agent will damage the water softener.

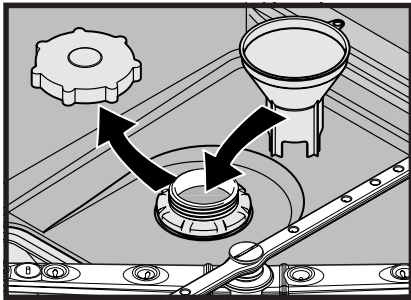

- Open the door.
- Unscrew the softener lid and fill the softener with 1.5 kg of “Granular regeneration salt” (2-8 mm) do not use salt tablets).
- Fill up the softener with potable water (only at the first run). Clean seal and rim of softener lid carefully, before closing the lid.
- Close lid and tighten.



Attention:
In order to prevent corrosion it is necessary to remove any salt residues from tank bottom. After manual removal, start a wash cycle to completely eliminate any remaining salt residue.

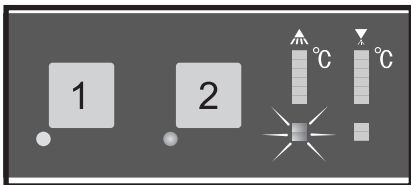

- Adjust the water hardness according to section 6.4. !
When the Salt indicator ⑥ flashes during operation, the softener has to be refilled with regeneration salt.
There will be a slight delay before salt light goes out after refill.

4. OPERATION

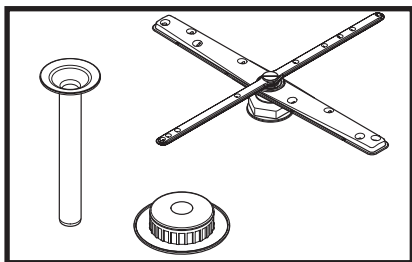

4.1. PREPARATION

- Check correct position of wash/rinse arms, strainer and overflow pipe.
- Open shut-off valve.
- Switch on main switch or put the plug in.

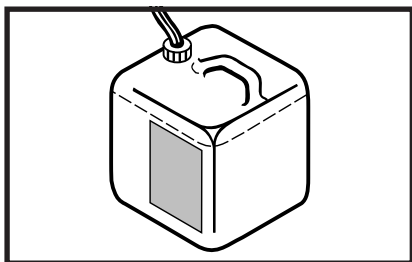

- Check level of detergent and rinse aid containers.

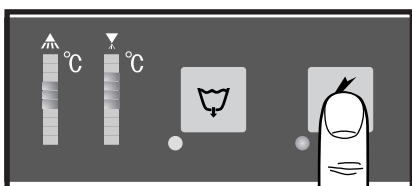

- Close door and push the ON button ①
 - tank will be filled.
 - The button LED flashes during fill and heating cycle. This process can take several minutes.
 - When the LED changes to steady burning light, machine is ready for operation.

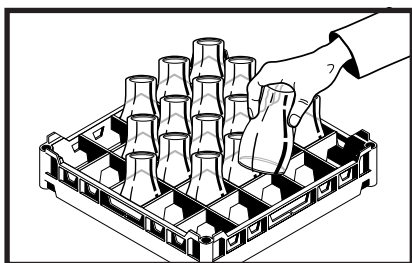

- Place glasses and cups face downwards into the rack.

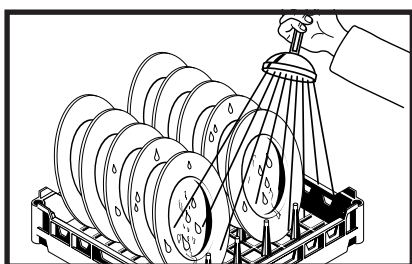

- Remove any food debris before loading plates into rack.
- Spray off greasy food leftovers.

4.2. RUN

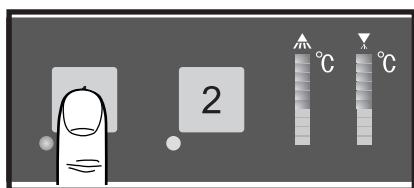
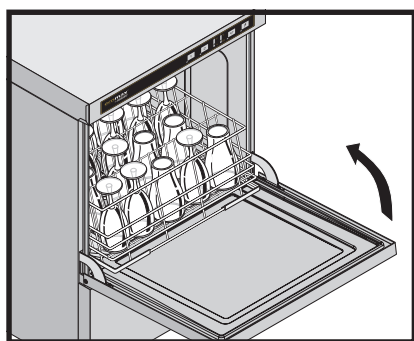

- Put rack into the machine and close the door.

- Start the program by pressing the desired program button 1 or 2.

Button "1" = Short cycle

Button "2" = Standard cycle

- The Program button LED flashes, wash cycle is running.
 - As soon as the LED changes to a steady light, the wash cycle is finished.
- Open the door and take out rack.
 - Allow dishes to dry for 1 minute approx.

5. SWITCH-OFF AND CLEANING THE MACHINE

5.1. SWITCH-OFF

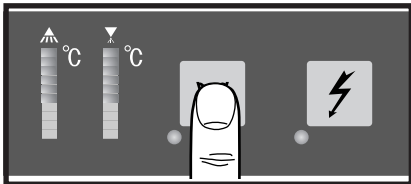
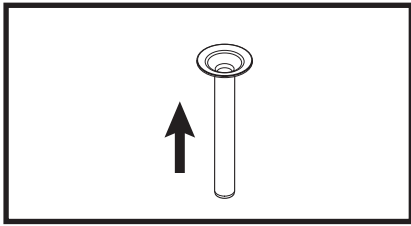

- Versions with overflow pipe: remove
- Close the door.

- Push and hold (min. 3 seconds) the Drain button ③
 - LED lights up.

The self-cleaning cycle will be started and the machine interior is cleaned automatically.

NOTE: A final inspection is recommended to remove any food debris.

- Machines with optional drain pump will drain the tank automatically.
- At the end of program, the machine switches off automatically.
- Switch off main switch or unplug. Close the shut-off valve.

5.2. CLEANING (DAILY)

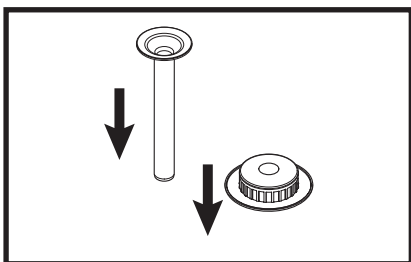
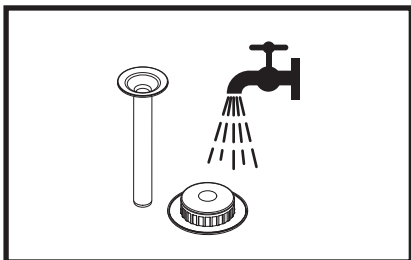

Attention:

To clean the machine do not use any chloric, acidic or abrasive products and no metallic brushes.

- Open door, take out strainer and overflow pipe.
Please ensure that food debris does not enter pump intake.
- Clean interior of the machine.
- Put strainer and overflow pipe back into place.

5.3. CLEANING (WEEKLY)

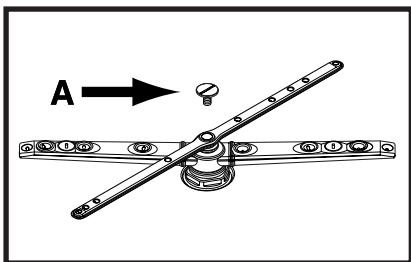

- Loosen the retaining screws (A) by turning them counter-clockwise.
- Take out and clean wash and rinse arms.
- Put all components back into place.

6.1. OPEN SETTING MENU



ATTENTION:
The machine has to be switched off.

- Open the door.

If the door is closed or if no button is pressed for 30 seconds, the indicator automatically switches off and the new settings will be saved. Therefore the setting procedure can be interrupted at any time.

- Push Program buttons ② simultaneously.
 - LEDs light up.
 - In the left display the bottom LED 1 is illuminated.

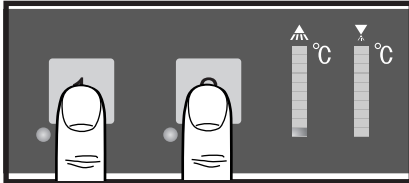

6.2. ADJUSTMENT OF DETERGENT DOSAGE QUANTITY

Only with built in detergent pump.

- If the LED 1 is lighted the right display indicates the adjusted value of the detergent dosage time: one LED corresponds to approx. 3.5 s \approx 1 g/l
- Pre-adjusted value: “11–13” = 10.5 s \approx 3 g/l.
- To adjust the detergent dosage time, push Program button “2” repeatedly, until the desired value (0–35 s \approx 0–10 g/l) is indicated.

Adjustment should be done in accordance with chemical suppliers recommendations.

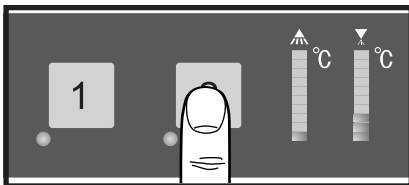

6.3. ADJUSTMENT OF RINSE AID DOSAGE QUANTITY

- Push Program button “1” again until
 - LEDs 1 and 2 illuminate in the left display.
 - the right display indicates the adjusted value of the rinse aid dosage time: One LED corresponds to approx. 2.5 s \approx 0,1 g/l.
- Pre-adjusted value: “11–13” = 7.5 s \approx 0,3 g/l.
- To adjust the rinse aid dosage time, push Program button “2” repeatedly, until the desired value (0–25 s \approx 0–1.0 g/l) is indicated.

Adjustment should be done in accordance with chemical suppliers recommendations.

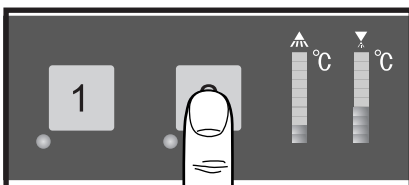
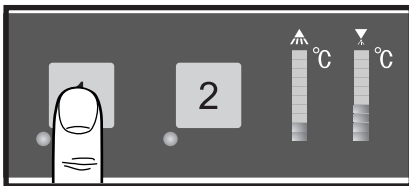

6.4. ADJUSTMENT OF WATER HARDNESS

NOTE: To enter the menu for setting the softener, see section 6.1. (previous page).

NOTE:

- With optional softener only.
- To adjust the softener to the local water hardness (obtain details from local water authority):
- Push Program button “1” again until
 - LEDs 1 to 3 illuminate in the left display

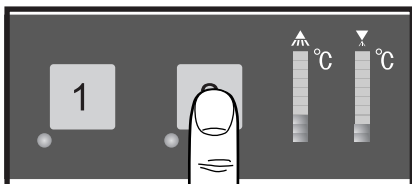
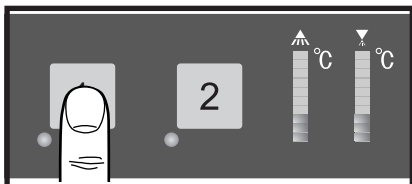

- Push Program button “2” repeatedly, until the LEDs in the left display correspond to the required value.

LED "on"	Range	Water hardness*
11	H01	up to 7°eh
11 and 12	H02	8 to 14°eh
11 to 13	H03	15 to 21°eh
11 to 14	H04	22 to 30°eh

* (°eh = Clark)

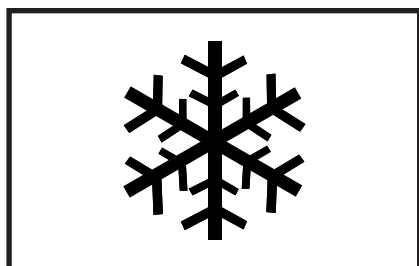

This should be carried out by service personnel!

In case of frost or longer operation pauses (e.g. for seasonal operations) the machine must be completely drained.

Reset for operation according to section 3.

8. MAINTENANCE



In order to maintain the warranty, as well as a permanently safe, efficient, and trouble-free operation of the machine, the required maintenance must be carried out by authorized service technicians.

For this reason, we recommend the conclusion of an inspection and maintenance contract which assures qualified support by specially trained service technicians according to a time scheduled based on the operating conditions.

9.1. POOR WASH RESULT

TYPE OF FAILURE	POSSIBLE CAUSE	REMEDY
Washware are not clean.	Wash arms stiff (you should be able to turn them easily by hand).	Take out wash arms and clean them thoroughly. Check water outlet from machine to wash arms is clear.
	Wash arm nozzles are clogged (visual check).	Take out wash arm, remove cleaning cap and rinse the wash arm thoroughly until soil is removed. Replace correctly.
	Rinse arm nozzles are clogged (possibly by lime deposit)	Remove rinse arms and decalcify them in separate container.
	Detergent concentration is too low or too high.	Check setting of detergent concentration. See also operating instructions point 6.1.
	Coarse strainer soiled.	Take out strainer, empty and clean it.
	Wrong program selected for heavily soiled washware.	Select program with longer wash cycle.
Dishes or glasses do not dry properly.	Rinse aid concentration too low.	Increase concentration. See also operating instructions point 6.2.
	Items to be washed still greasy.	Detergent concentration too low: increase (see instructions). Check if detergent is appropriate. If not choose a stronger one. Drain soiled water and refill machine. Check pre-scrapping procedure.
	Rack is not suitable for type of washware.	Use appropriate racks to create a sloping position which allows water to drain away from cavities.
	Washware stays too long in the machine at the end of program.	Take out washware as soon as cycle is completed to enable the ware to dry.
Stripes and stains on dishes or glasses.	Rinse aid concentration too high.	Reduce quantity (see instructions).
	Hard water or high mineral content.	Check water quality. Obtain details from local water authority. Recommended values: Ideal degree of hardness is 4° Clark. Ideal conductivity value for glasses is max. 150 µS/cm and for dishes max. 400 µS/cm.
	Rack is not suitable for type of washware.	Use appropriate racks to create a sloping position which allows water to drain away from cavities.
	Insufficient rinse aid concentration causes stains	Increase quantity (see instructions)
	Machine with softener: Wrong type of salt used.	Use only granular regeneration salt.

9.2. OTHER FAULTS

TYPE OF FAILURES	POSSIBLE CAUSE	REMEDY
Glasses are totally or partially cloudy	Surface of glasses is rough and porous, this is called glass corrosion	This is not caused by a malfunction on the machine. Replace with new glasses.
Glass breakages.	Use of inappropriate dish or glass racks.	Use appropriate racks.

9.3. MALFUNCTIONS

TYPE OF FAILURES	POSSIBLE CAUSE	REMEDY
Machine suddenly stops during wash program.	Machine is connected to an energy management system which cuts out the energy consumer at a given point, or machine is interlocked with another energy consumer unit.	Connect machine separately (call electrician).
	Blown site fuse.	Check site fuses.
	Temperature probe rinse booster or tank defective.	Call the after sales service.
	Pressure transmitter rinse booster or tank defective.	Call the after sales service.
The four button LEDs flash.	Control defective.	Call the after sales service.

HOBART GmbH
Robert-Bosch-Str. 17
77656 Offenburg
Tel. +49(0)781.600-0
Fax +49(0)781.600-23 19
E-Mail: info@hobart.de
Internet: www.hobart.de

As continued product improvement is a policy of HOBART,
specifications are subject to change without notice.