

Installation Manual

PanCake® Level Sensor PR 6251



Foreword

Must be followed!

Any information in this document is subject to change without notice and does not represent a commitment on the part of Minebea Intec unless legally prescribed. This product should only be operated/installed by trained and qualified personnel. In correspondence concerning this product, the type, name, and release number/serial number as well as all license numbers relating to the product have to be cited.

Note

This document is partially protected by copyright. It may not be changed or copied, and it may not be used without purchasing or written permission from the copyright owner (Minebea Intec). The use of this product constitutes acceptance by you of the abovementioned provisions.

Table of contents

1	Introduction.....	3
1.1	Read the manual.....	3
1.2	This is what operating instructions look like.....	3
1.3	This is what lists look like.....	3
1.4	This is what menu items and softkeys look like.....	3
1.5	This is what the safety instructions look like.....	3
1.6	Hotline.....	4
2	Safety instructions.....	5
2.1	General notes.....	5
2.2	Intended use.....	5
2.3	Initial inspection.....	5
2.4	Before operational startup.....	5
3	Recommendations for installation.....	6
3.1	Load cell arrangement.....	6
3.2	Number of sensors.....	6
3.3	Selecting maximum capacity.....	6
4	Specifications.....	7
4.1	Equipment supplied with the load cell.....	7
4.2	General information.....	7
4.3	Possible marking of the load cell for the Ex area.....	8
4.4	Dimensions.....	9
4.5	Ordering information.....	10
4.6	Technical data.....	10
5	Installation.....	12
5.1	Safety instructions.....	12
5.2	Level sensor 500 kg...5 t with transition plate PR 6051/00S and base plate PR 6051/12S.....	13
5.3	Level sensor 10 t...16 t with transition plate PR 6051/00S and base plate PR 6051/12S.....	14
6	Connection.....	15
6.1	General information.....	15
6.2	Level sensor.....	16
6.2.1	Connecting a level sensor.....	17
6.2.2	Connecting two level sensors.....	17
6.3	Cable connections.....	18
7	Preparing for calibration.....	19
7.1	General notes.....	19
7.2	Smart Calibration.....	19

7.3	Mechanical height adaptation	20
8	Troubleshooting	21
8.1	General Notes	21
8.2	Visual inspection	21
8.3	Metrological controls	21
8.3.1	Checking the zero output signal of the load cell	21
8.3.2	Checking the strain gauge bridge of the load cell	21
8.3.3	Checking the insulation impedance of the load cell	22
8.3.4	Checking the insulation impedance of the connecting cable	22
9	Maintenance/repairs/cleaning	23
9.1	Maintenance	23
9.2	Repairs	23
9.3	Cleaning	23
10	Disposal	24
11	Accessories	25
11.1	Mounting plates and screw-in adapters	25
11.2	Connecting cables	25
11.3	Cable junction boxes	25
12	Certificates/safety instructions/control drawing	27
12.1	BVS 16 ATEX E 005	28
12.2	IECEX BVS 16.0005	32
12.3	TÜV 03 ATEX 2301X	36
12.4	IECEX TUN 17.0025X	42
12.5	MIN16ATEX001X	46
12.6	FM17CA0138	48
12.7	FM17US0276	51
12.8	4012 101 5688	54
12.9	MEU17031	55
12.10	RU Д-DE.A301.B.05345	61

1 Introduction

1.1 Read the manual

- Please read this manual carefully and completely before using the product.
- This manual is part of the product. Keep it in a safe and easily accessible location.

1.2 This is what operating instructions look like

1. - n. are placed before steps that must be done in sequence.
 - ▶ is placed before a step.
 - ▷ describes the result of a step.

1.3 This is what lists look like

- indicates an item in a list.

1.4 This is what menu items and softkeys look like

[] frame menu items and softkeys.

Example:

[Start]- [Applications]- [Excel]

1.5 This is what the safety instructions look like

Signal words indicate the severity of the danger involved when measures for preventing hazards are not followed.

DANGER

Warning of personal injury

DANGER indicates death or severe, irreversible personal injury which will occur if the corresponding safety measures are not observed.

- ▶ Take the corresponding safety precautions.

WARNING

Warning of hazardous area and/or personal injury

WARNING indicates that death or severe, irreversible injury may occur if appropriate safety measures are not observed.

- ▶ Take the corresponding safety precautions.

CAUTION

Warning of personal injury.

CAUTION indicates that minor, reversible injury may occur if appropriate safety measures are not observed.

- ▶ Take the corresponding safety precautions.

NOTICE**Warning of damage to property and/or the environment.**

NOTICE indicates that damage to property and/or the environment may occur if appropriate safety measures are not observed.

- ▶ Take the corresponding safety precautions.
-

Note:

User tips, useful information, and notes.

1.6 Hotline

Phone: +49.40.67960.444

Fax: +49.40.67960.474

eMail: help@minebea-intec.com

2 Safety instructions

2.1 General notes

NOTICE

Warning of damage to property and/or the environment.

The product was in perfect condition with regard to safety features when it left the factory.

- ▶ To maintain this condition and to ensure safe operation, the user must follow the instructions and observe the warnings in this manual.

2.2 Intended use

The level sensor PR 6251 is specially designed for easy weighing of silos and horizontal tanks, but also bulk and liquid materials.

The level sensor PR 6251 (hereinafter also referred to as sensor or load cell) may be used only for tank level measurements or weighing tasks as intended.

In intrinsically safe circuits, only load cells PR 6251/..LE may be used.

The dimensions of all mounting and structural components must be calculated so that sufficient overload capacity is ensured for all loads which may occur while taking the relevant standards into account. In particular, upright weighing objects must be safeguarded against the weighing installation turning over or being shifted, thus eliminating danger to people, animals, or goods even in the case of a break in a load cell or mounting element.

Installation and repair work must only be carried out by expert/qualified personnel.

The load cell reflects the state of the art. The manufacturer does not accept any liability for damage caused by third-party system components or due to incorrect use of the product.

2.3 Initial inspection

Check the contents of the consignment for completeness. Check the contents visually to determine whether any damage has occurred during transport. If there are grounds for rejection of the goods, a claim must be filed with the carrier immediately. The Minebea Intec sales or service organization must also be notified.

2.4 Before operational startup

NOTICE

Perform visual inspection.

- ▶ Before operational startup as well as after storage or transport, inspect the load cell visually for signs of mechanical damage.

3 Recommendations for installation

3.1 Load cell arrangement

- The supporting structure of the scale (i.e. the load cell support) and the vessel must be stable enough to withstand the specified loads, be horizontal (water level!) and flat.
- Transverse and/or horizontal forces and torques exceeding the permissible limits are disturbances which can generate measuring errors and, in the worst case, may damage the load cell.
- If the object to be measured is constrained properly, damage and measuring errors can be prevented without affecting the required space for movement in the direction of the measurement.

Consideration should be given to the fact that thermal expansion and contractions may constrict the required space for movement of the object to be weighed and could thereby lead to significant falsification of the measuring results.

Therefore, special attention should be paid to the design, arrangement, and condition of the constrainers.

3.2 Number of sensors

Number of vessel feet	Model	Number of sensors
3	PR 6251/..L, PR 6251/..LE	1 or 3
4	PR 6251/..L, PR 6251/..LE	2 or 4
3	PR 6251/..LA	1
4	PR 6251/..LA	2

3.3 Selecting maximum capacity

Parameters may change or the level sensor can be damaged when the safe load limit E_{lim} of the level sensor is exceeded.

If the destructive load E_d of the level sensor is exceeded, there is danger of mechanical destruction.

If the safe load limit E_{lim} of the level sensor can be exceeded, e.g. by falling loads, then mechanical limiting in load direction is strongly recommended.

The maximum capacity for the sensor is determined using the weight on the vessel foot.

Examples:

Container weight + max. content [t]	Sensor [pcs.]	Vessel feet [pcs.]	Weight per foot [t]	Maximum capacity (for each sensor) [t]
12	1 (3)	3	4.00	5
11	2 (4)	4	2.75	3

4 Specifications

4.1 Equipment supplied with the load cell

No.	Description
1	Level sensor
2	Quick guide
3	Calibration Certificate
4	Only with Ex-load cells: Safety information for Ex-load cells

4.2 General information

Load cell material	Load graduations 500 kg...5 t: Stainless steel 1.4057 acc. to DIN EN 10088-3 Load graduations 10 t und 16 t: Stainless steel 1.4542 acc. to DIN EN 10088-3
Protection against environmental influences	Hermetically sealed by welding. Filled with polyurethane.
Protection classes	in compliance with IEC 529 or DIN EN 60529 IP66/IP68/IP69: Dust-proof and leak-tight against water, with harmful effects when immersed, (1.5 m water depth, 10,000 h) and water jets (high pressure and temperature). Explosion: Suitable for explosion subgroup IIC and IIIC.
Protection type	Intrinsic safety for PR 6251/..LE
Ambient temperature in the Ex area	see additional information "safety instructions for Ex load cells"
Cable diameter	5 mm
Cable length	5 m
Cable gauge	4x0.35 mm ²
Cable bend radius	≥25 mm (fixed installation) ≥75 mm (flexible installation)
Cable sheath material	Thermoplastic elastomer (TPE)
Cable sheath color	Gray (standard version) Blue (Ex version) Green (LA version)

4.3 Possible marking of the load cell for the Ex area

Zone	Marking	Certificate no.	for
0 and 1	II 1G Ex ia IIC T6 Ga Ex ia IIC T6 Ga	BVS 16 ATEX E 005 IECEX BVS 16.0005	only PR 6251/..LE
20 and 21	II 1D Ex ta IIIC T160 °C Da Ex ta IIIC T160 °C Da	TÜV 03 ATEX 2301X IECEX TUN 17.0025X	only PR 6251/..L
2	II 3G Ex nA IIC T6 Gc	MIN16ATEX001X	only PR 6251/..L
22	II 3D Ex tc IIIC T85 °C Dc	MIN16ATEX001X	only PR 6251/..L
	IS CL I, II, III, DIV 1, GP A, B, C, D, E, F, G Entity - 4012 101 5688 NI CL I, II, III, DIV 2, GP A, B, C, D, E, F, G - 4012 101 5688; NIFW T4A Ta= -40°C to 70°C; T5 Ta= -40°C to 55°C	FM17US0276	only PR 6251/..L
	IS CL I, II, III, DIV 1, GP A, B, C, D, E, F, G Entity - 4012 101 5688 NI CL I, II, III, DIV 2, GP A, B, C, D, E, F, G - 4012 101 5688; NIFW T4A Ta= -40°C to 70°C; T5 Ta= -40°C to 55°C	FM17CA0138	only PR 6251/..L

NOTICE

Installation in the Ex area

- For installations in the Ex area, it is imperative to observe the Ex safety instructions in the installation manuals.

4.4 Dimensions

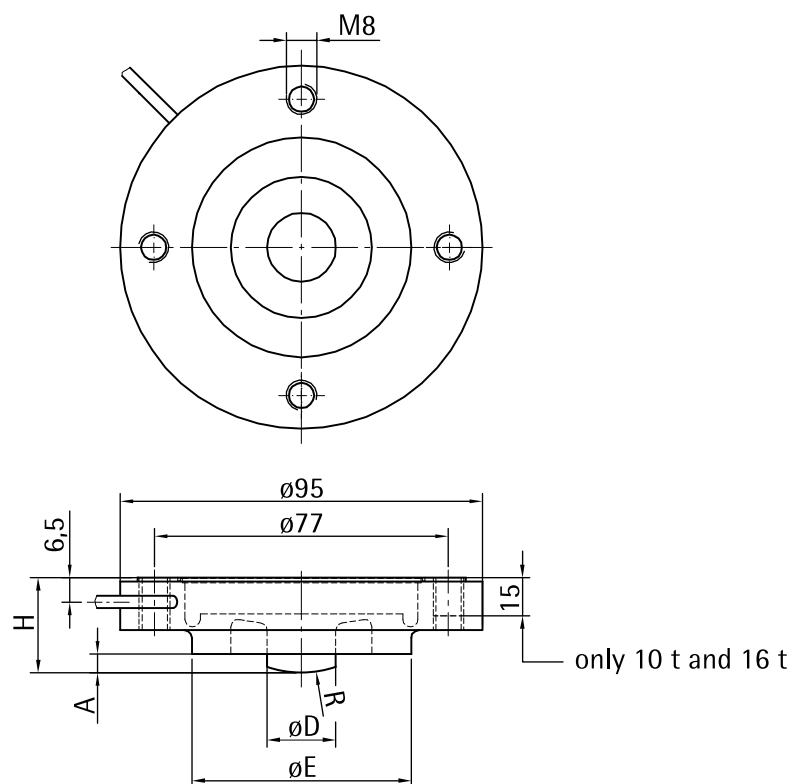

all dimensions in mm

Model	A [mm]	D [mm]	E [mm]	H [mm]	R [mm]
PR 6251/52	5	18	57.5	25	25
PR 6251/13:	5	18	57.5	25	25
PR 6251/23	5	18	57.5	25	25
PR 6251/33	5	18	57.5	25	50
PR 6251/53	3	18	63.0	25	50
PR 6251/14:	8	21.7	57.5	35	70
PR 6251/24:	5	23	67	35	100

4.5 Ordering information

Model	Max. capacity E_{max}	Type
PR 6251/52	500 kg	..L/LA/LE
PR 6251/13	1 t	..L/LA/LE
PR 6251/23	2 t	..L/LA/LE
PR 6251/33	3 t	..L/LA/LE
PR 6251/53	5 t	..L/LA/LE
PR 6251/14	10 t	..L/LA/LE
PR 6251/24	16 t	..L/LA/LE

Legend		
L	=	Standard
LA	=	with amplifier
LE	=	Ex version

4.6 Technical data

Designation	Description	Abbr.	L/LE	LA	Unit
Accuracy class			0.5	0.5	% E_{max}
Minimum dead load	lowest limit of specified measuring range	E_{min}	0	5	% E_{max}
Maximum capacity	highest limit of specified measuring range	E_{max}	See Chapter 4.5		
Safe load limit	maximum load without irreversible damage	E_{lim}	150	120	% E_{max}
Destructive load	danger of mechanical destruction	E_d	>300	>300	% E_{max}
Rated output	relative output at maximum capacity	C_n	2 mV/V	16 mA	
Tolerance on rated output	permissible deviation from rated output C_n	d_c	<4	<4	% C_n
Zero output signal	load cell output signal under unloaded condition	S_{min}	$0 \pm 4 \% C_n$	$4 \text{ mA} \pm 4 \% C_n$	
Repeatability	max. change in load cell output for repeated loading	ϵ_R	<0.1	<0.1	% C_n
Creep	max. change of output signal at E_{max} during 30 minutes	d_{cr}	<0.1	<0.1	% C_n

Designation	Description	Abbr.	L/LE	LA	Unit
Non-linearity ¹⁾	deviation from best straight line through zero	d _{Lin}	<0.25	<0.25	% C _n
Hysteresis ¹⁾	max. difference in LC output between loading and unloading	d _{hy}	<0.15	<0.15	% C _n
Temperature effect on S _{min}	max. change of S _{min} in ambient temperature range	TK _{Smin}	<0.15	<0.15	% C _n /10 K
Temperature effect on C ¹⁾	max. change of C in ambient temperature range	TK _C	<0.1	<0.1	% C _n /10 K
Input impedance	between supply terminals	R _{LC}	645 ±60	...	Ω
Output impedance	between measuring terminals	R ₀	635 ±15	...	Ω
Insulation impedance	between measuring circuit and housing, U _{DC} = 100 V	R _{IS}	>5000	...	MΩ
Recommended supply voltage	to hold the specified performance	B _u	4...24	20...28	V
Max. supply voltage	permissible for continuous operation without damage	U _{max}	32/25	28	V
Nominal ambient temp. range	to hold the specified performance	B _T	-10...+70/ -10...+55	-10...+55	°C
Usable ambient temp. range	permissible for continuous operation without damage	B _{Tu}	-30...+95	-30...+70	°C
Storage temperature range	without electrical and mechanical stress	B _{Ti}	-40...+95	-40...+80	°C
Permissible eccentricity	permissible displacement from nominal load line	S _{ex}	10	10	mm
Vibration resistance	resistance against oscillations (IEC 60068-2-6-Fc)		20 g, 100 h, 10...150 Hz	20 g, 100 h, 10...150 Hz	
Barometric pressure influence	influence of barometric pressure on output	PK _{Smin}	<20	<20	g/kPa
Nominal deflection	elastic deformation under maximum capacity	S _{nom}	up to 2 t <0.1/ up to 16 t <0.2	up to 2 t <0.1/ up to 16 t <0.2	mm

1) The data for non-linearity (d_{Lin}), hysteresis (d_{hy}) and and temperature effect on C (TK_C) are typical values.
For OIML R60 or NTEP approved load cells the sum of these values is within the permissible cumulative error limits.

Definitions acc. to OIML R60

The technical data given are intended solely as a product description and should not be interpreted as guaranteed properties in the legal sense.

5 Installation

5.1 Safety instructions

NOTICE

Welding or lightning strike current flowing through the sensor may damage it.

All electrical welding on the weighing system must be finished before mounting the sensors.

- ▶ Immediately bypass the sensor when installing.

During any additional electrical welding work near the sensor:

- Disconnect the sensor cables.
- Bypass the sensor.
- Make sure that the grounding clamp of the welding set is fitted as closely as possible to the welding joint.

The following must be observed during installation:

- Do not lift or transport the sensor by pulling on the cable.
- Avoid shock stress (falling down, hard shocks).
- Load forces must act in the exact measuring direction of the level sensors.

NOTICE

Changes of temperature >15 K/h may influence the measuring accuracy.

- ▶ Make sure to protect the load cells from direct heating or cooling effects (sun, wind, heat radiation, fan heaters), e.g., heat protection screens or heat protection housings are to be installed if necessary.

NOTICE

Force shunts may cause measuring errors.

- ▶ All incoming and outgoing lines (hoses, pipes, cables) must be coupled to the measured object as flexibly as possible.

5.2 Level sensor 500 kg...5 t with transition plate PR 6051/00S and base plate PR 6051/12S

Note:

For further information, see Chapter [11.1](#) and any supplementary information on the respective accessories.

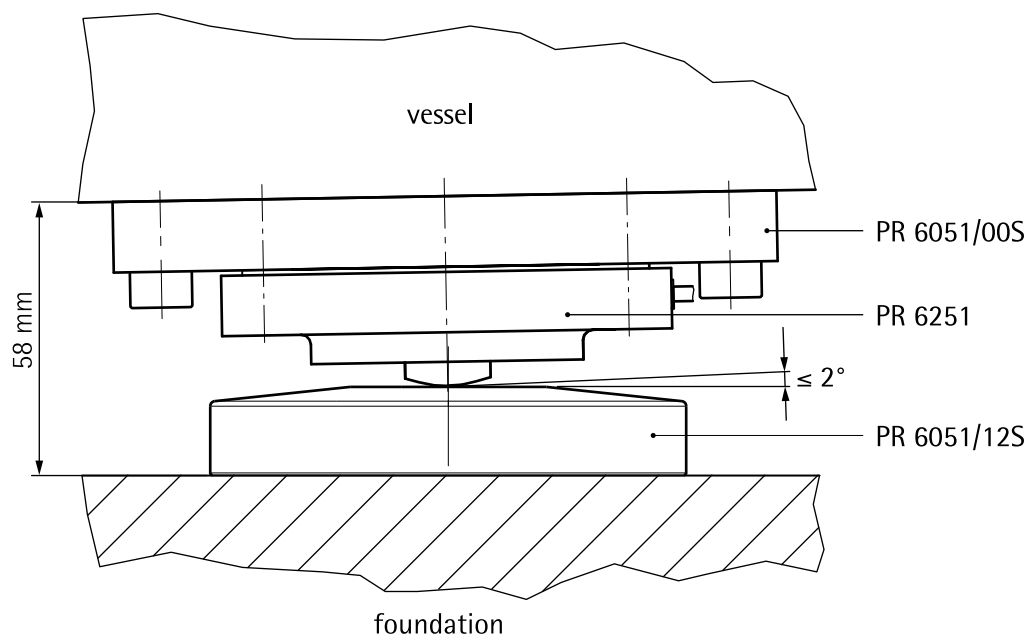

5.3 Level sensor 10 t...16 t with transition plate PR 6051/00S and base plate PR 6051/12S

Note:

For further information, see Chapter [11.1](#) and any supplementary information on the respective accessories.

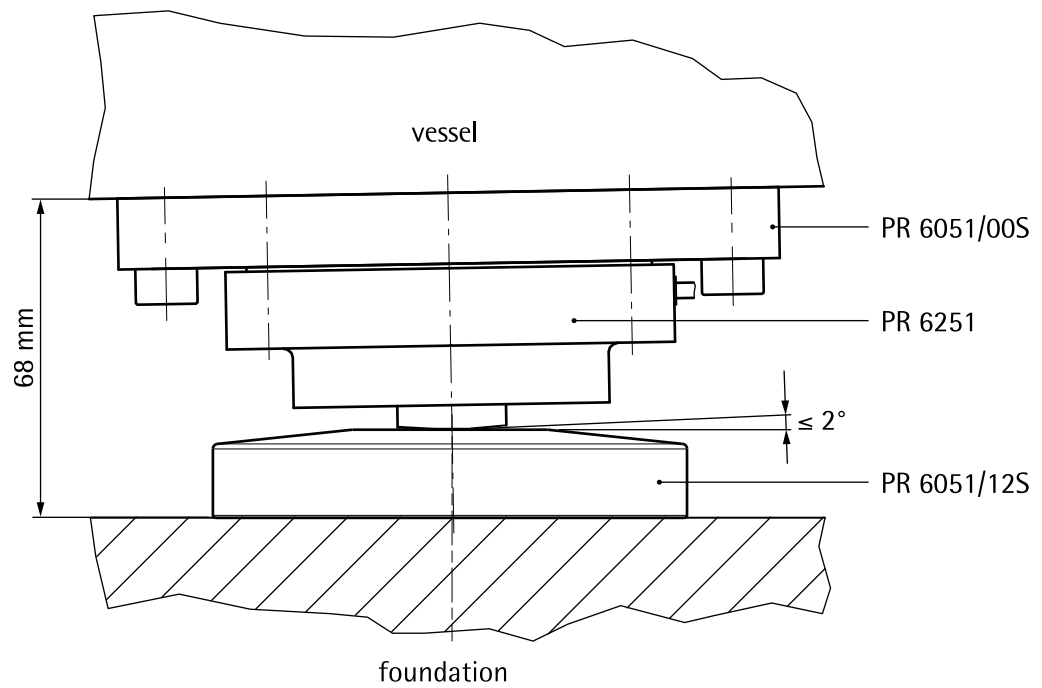

6 Connection

6.1 General information

- Protect the cable ends against contamination. Moisture must not get into the open end of the cable.
- Do not shorten the load cell connecting cable. Connect the prepared cable end and roll up the remaining cable.
- The screen of the load cell cable and the screen of the connecting cable must not be connected inside the cable junction box if connection of both ends is not permissible according to the regulations for installation in the explosion-prone area.
- Keep the load cell cables away from power cables.
- The distance between measurement cables and power cables and/or components under high voltage should be at least 1 m (reference value).
- We recommend laying the load cell cables in separate cable trays or armored steel pipes.
- Power cables should be crossed at right angles while taking into account the minimum distance of 1 m (reference value).

Note:

If hum interference occurs, the cable screens should only be connected on one side.

Depending on the design of the cable junction box used, either the jumper J3 must be removed or the cable screens must be disconnected from the terminal contacts highlighted in yellow.

⚠ WARNING**When installing in potentially explosive atmospheres:**

It is imperative that you follow the application-dependent installation instructions!

- ▶ Always check whether it is permissible to bilaterally connect the screens to the equipotential bonding.
-

6.2 Level sensor

Color Code

rd	=	red
gn	=	green
bu	=	blue
gy	=	gray

Standard (type L, LE)

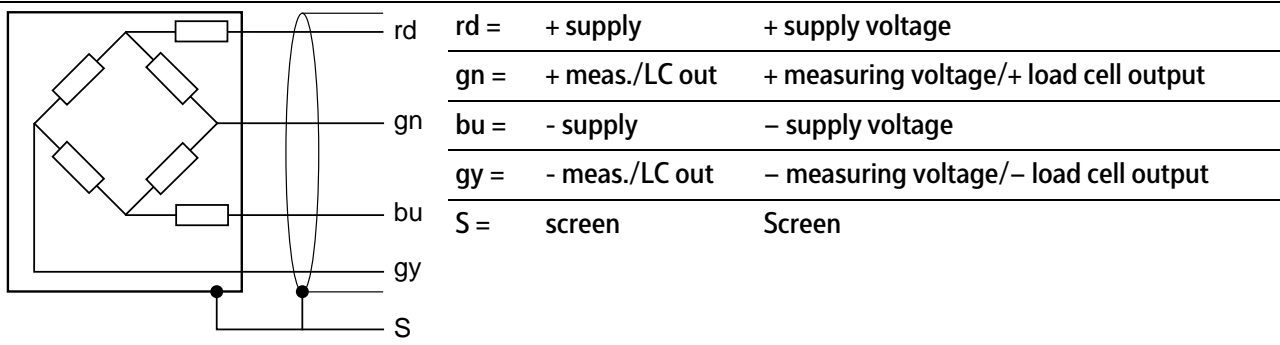

Load cell with integrated amplifier (Type LA)

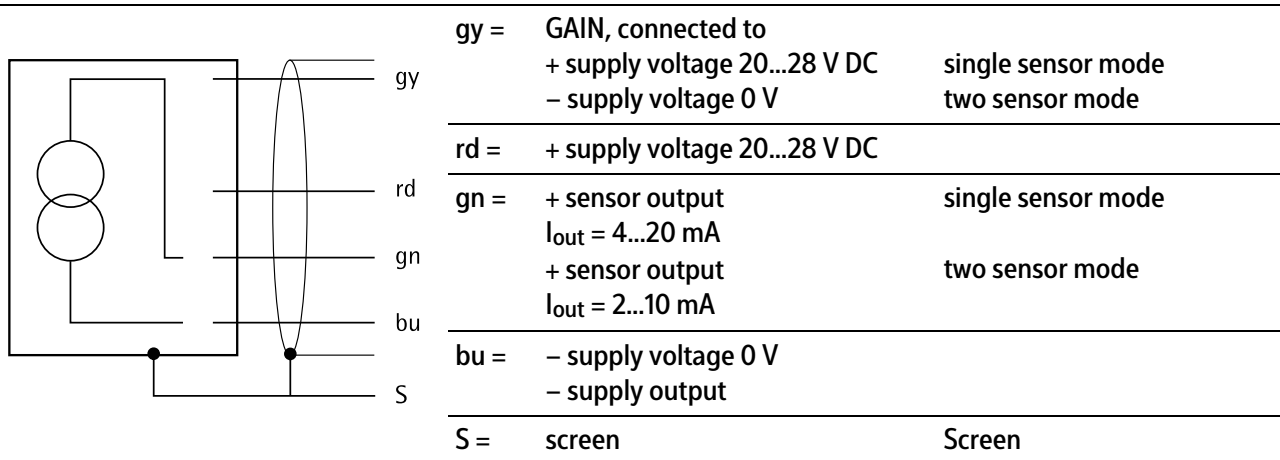

6.2.1 Connecting a level sensor

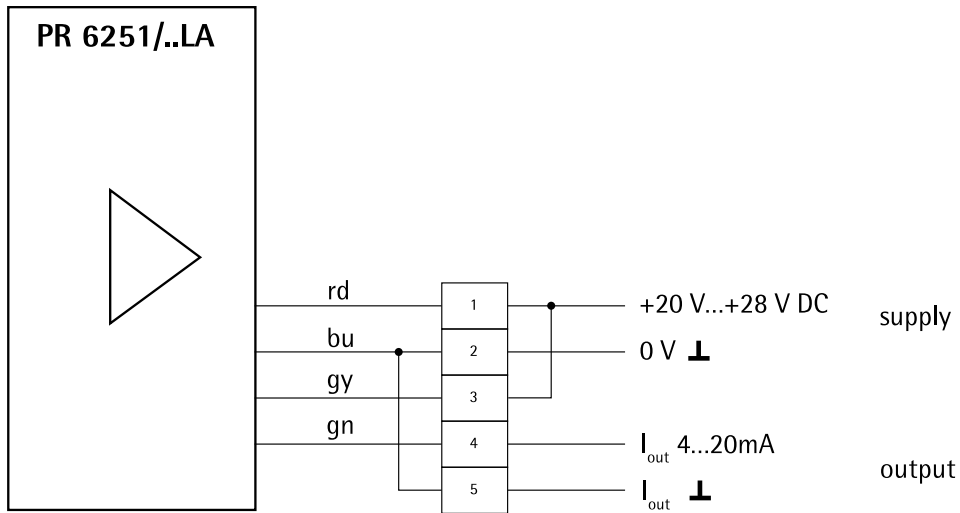

6.2.2 Connecting two level sensors

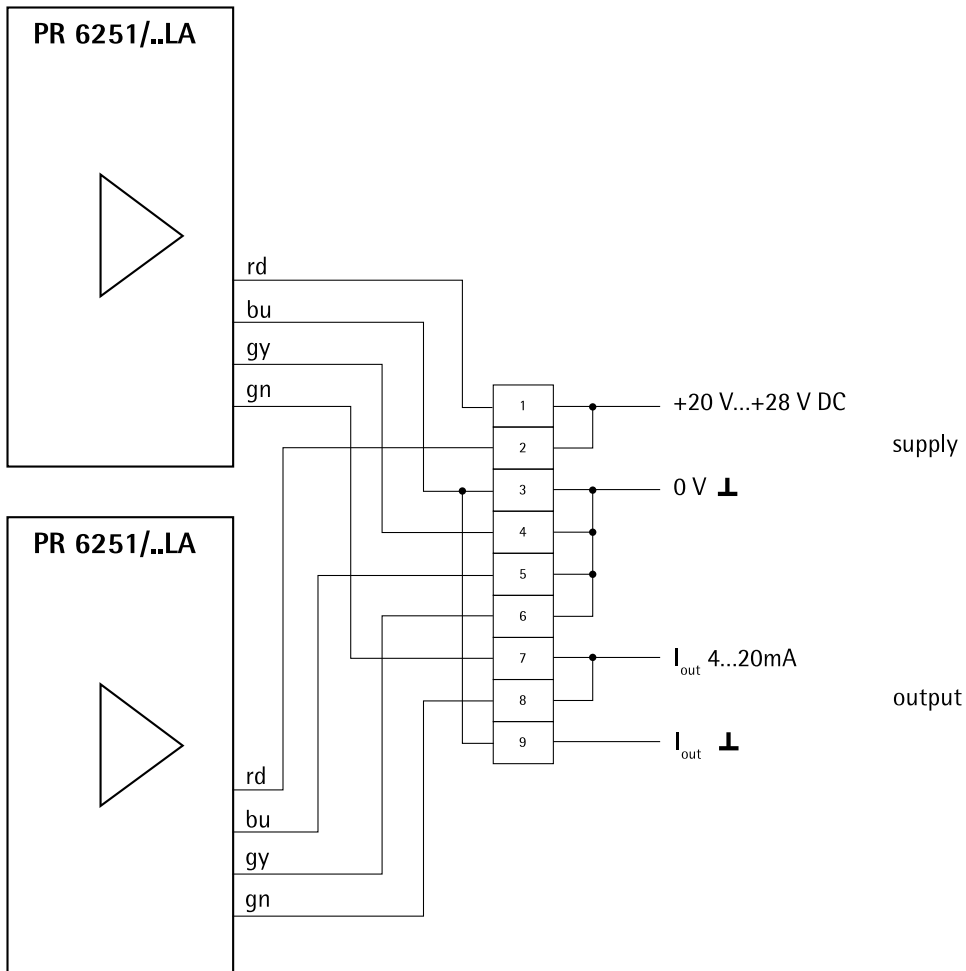

6.3 Cable connections

Note:

All components are only shown schematically.

Color code

bk	=	black
bu	=	blue
gn	=	green
gy	=	gray
rd	=	red
wh	=	white

Connection example: Type L, LE

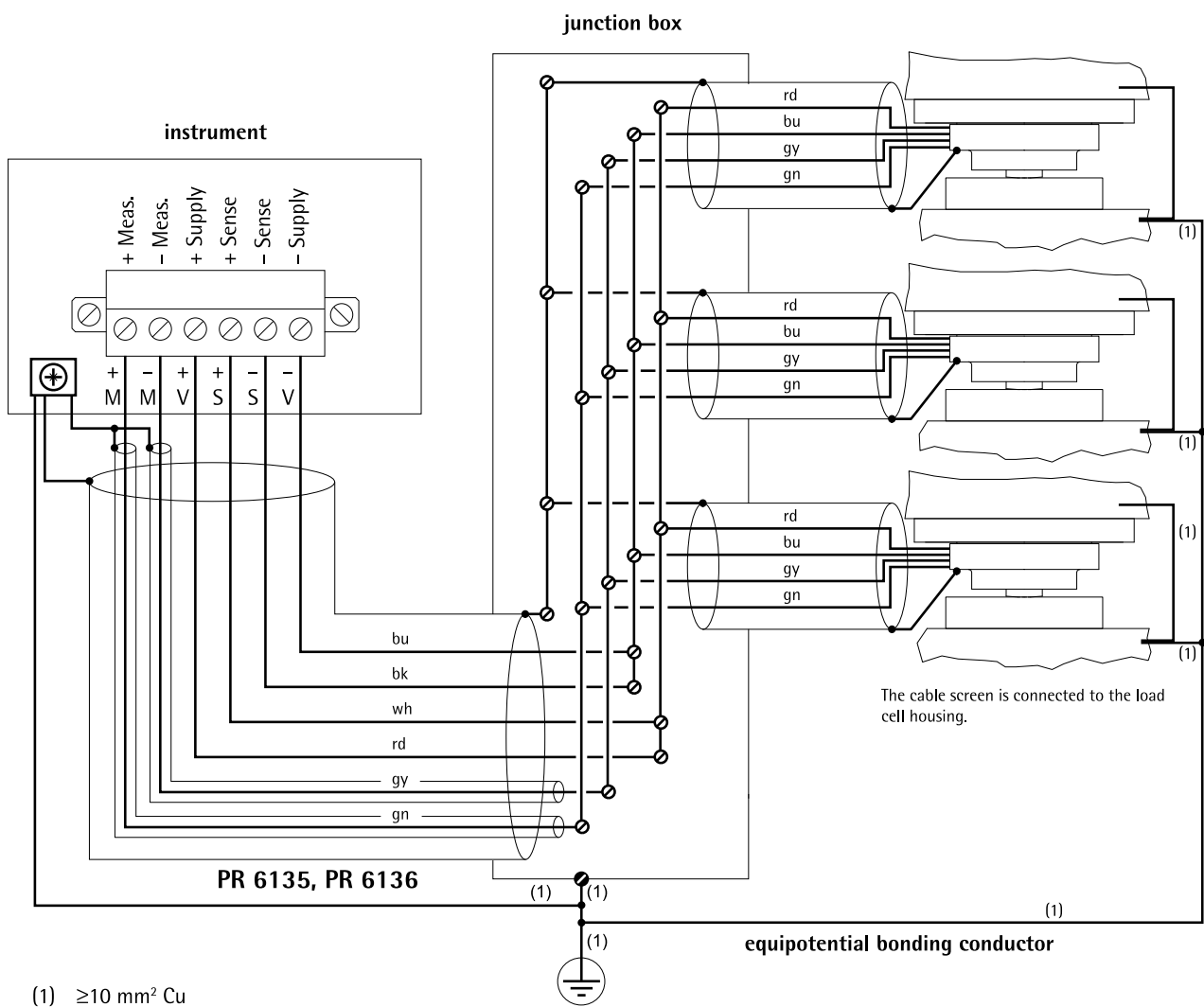

7 Preparing for calibration

7.1 General notes

Note:

For calibration of the measuring system, please refer to the manual of the corresponding indicator.

7.2 Smart Calibration

When using Minebea Intec devices, we recommend always running "Smart Calibration" first.

This allows all required values to be extracted from the Calibration Certificate supplied.

- The "Hysteresis correction values for Smart Calibration" listed on the Calibration Certificate are entered for [Correction A] and [Correction B] under [Hysteresis error] - [specified] in the indicator.

If the values are not available on the Calibration Certificate, [Hysteresis error] - [not specified] must be selected.

- The value listed under "Output at max. capacity" on the Calibration Certificate is entered in the indicator under [LC output at max. capacity].
- The value listed under "Output impedance" on the Calibration Certificate is entered in the indicator under [LC output impedance].

By performing these steps, a logical and highly accurate reading (typically better than 0.1%) is generated before the scale is even loaded for the first time.

7.3 Mechanical height adaptation

To distribute the load over the load cells as evenly as possible, height adaptation is required in systems with more than 3 load cells prior to calibration.

Note:

Height adaptation is only possible for level sensors of types L and LE.

Procedure:

1. Place the dead load (e.g. empty vessel) onto the load cells of the scale structure.
2. Energize the load cells in parallel with a stabilized voltage (e.g.: $U_{DC} = 12\text{ V}$).
3. Measure the output voltages of each individual load cell by means of a digital voltmeter and compare the individual values.
 - ▷ Given deviation between the output voltages of the load cells, the load on the load cell with the lowest output voltage must be increased by putting shims between mounting plate and weighing construction.
4. Lift the weighing object immediately beside the affected load cell.
5. Place thin, deburred sheets of metal (0.5–2 mm thick) between the transition plate and the vessel.
6. Measure the output voltages of the load cells again and adjust the height of this load cell or of another one.

8 Troubleshooting

8.1 General Notes

The following hints will enable a technician to do an initial diagnostic or help in case of incorrect or non-reproducible weighing results after commissioning and calibration.

8.2 Visual inspection

Component	Possible errors
Weighing object	Are all pipes, hoses and cables free from shunt forces? Are the connections pliable and connected horizontally? Are elements with a solid connection to the scale in direct contact with the surroundings? Has friction developed between the weighing object and its surroundings (e. g. dusty openings, ...)?
Cable junction box	Has moisture intruded? Do all soldering and screw connections have secure contact?
Connecting cables	Is the sheath damaged? Has moisture intruded?
Load cell	Is the load cell parallel to the contact area? Is the sheath of the load cell cable damaged? Has moisture penetrated into the load cell cable?

8.3 Metrological controls

8.3.1 Checking the zero output signal of the load cell

- Unload load cell.
- Disconnect the load cell measuring outputs.
- Check whether the output voltage without load is within the limits.

Type	Output voltage
L, LE	0 mV \pm 0.08 mV/V
LA	3.2... 4 mA GAIN connected to +supply voltage 24 \pm 4 V, see Chapter 6.2.1 .

8.3.2 Checking the strain gauge bridge of the load cell

Note:

Only possible for level sensors of type L and LE.

- Do not exceed the test voltage.
- Check whether the values of the resistors are within the permissible limits.

Max. test voltage

- Type L: $U_{DC} = 32\text{ V}$
- Type LE: $U_{DC} = 25\text{ V}$

Type	Input impedance (red core, blue core)	Output impedance (green core, gray core)
L, LE	$645\ \Omega \pm 60\ \Omega$	$635\ \Omega \pm 15\ \Omega$

8.3.3 Checking the insulation impedance of the load cell**NOTICE****Possible destruction of load cell**

- ▶ Never apply test voltage between two cores of the load cell cable.
- ▶ Insulate the load cell cores.

Note:

Only possible for level sensors of type L and LE.

Max. test voltage

- Type L: $U_{DC} = 100\text{ V}$
- Type LE: $U_{AC} = 500\text{ V}$

Insulation impedance	Core – housing	>5000 M Ω
	Core – screen	>5000 M Ω
	Screen – housing	>5000 M Ω

8.3.4 Checking the insulation impedance of the connecting cable

- Disconnect connecting cable from measuring instrument and load cells.
- Insulate the cores of the connecting cable.

Insulation impedance	Core – core	>120 M $\Omega \times \text{km}$
	Core – screen	>120 M $\Omega \times \text{km}$

9 Maintenance/repairs/cleaning

9.1 Maintenance

The load cell PR 6251 is maintenance-free.

Load cell grease must be applied to the level sensor mounting parts.

The load cell can be extensively sprayed with off-shore all-weather protection spray in aggressive environments.

Load cell grease specification

- good water/media resistance
- good corrosion protection properties
- good oxidization and aging stability
- good temperature resistance
- and, where appropriate, good compatibility with foodstuffs

The requirements referred to apply when taking into account the specific operating/usage conditions.

The grease also serves as protection against wear (low friction).

9.2 Repairs

The load cell PR 6251 is designed to be as robust as possible for the required measuring accuracy and is highly reliable.

Should an electrical or mechanical defect nevertheless occur, the load cell must be replaced.

Load cell repair is not possible.

9.3 Cleaning

Dirt on the load cell and movable parts of the scale must be cleaned as quickly as possible

- if it influences weighing, or
- if it is corrosive to the cell or cable material.

NOTICE

Some cleaning agents may not be compatible with the load cell material.

- ▶ When using cleaning agents, ensure that their compatibility with the load cell material has been tested and approved (see Chapter [4.2](#)).

10 Disposal

Our products and their packaging should not be disposed of in municipal waste (e.g. garbage can for recyclable packaging, garbage can for paper packaging, etc.). They can either be recycled by the customer themselves, providing this complies with requirements set out by electrical or electronic waste or packaging waste laws, or sent back to Minebea Intec at a charge.

This option of returning the product is intended to provide proper recycling or reuse in a manner that is collected separately from municipal waste.

Before disposing of or scrapping the old products, any single-use or rechargeable batteries should be removed and taken to a suitable collection point. The type of battery used is specified in the technical data.

Please see our General Terms and Conditions for further information.

Service addresses for repair acceptance and collection points can be found on the product information enclosed with the product as well as on our website (www.minebea-intec.com).

Should you have any further questions, please contact your local service representative or our service center.

Minebea Intec GmbH

Repair center

Meiendorfer Strasse 205 A

22145 Hamburg, Germany

Phone: +49.40.67960.333

service.HH@minebea-intec.com

We reserve the right not to accept products that are contaminated with hazardous substances (ABC contamination).

11 Accessories

11.1 Mounting plates and screw-in adapters

To install the load cell, the following mounting plates and screw-in adapters are recommended:

No.	Description	Max. capacity	Order no.
1	Transition plate PR 6051/00S (1.4301)		9405 361 51002
2	Base plate PR 6051/12S (1.4542)		9405 361 51122
3	Screw-in adapter PR 6051/20S (1.4301; can be used in combination with base plate PR 6051/12S)	500 kg...2 t	9405 360 51202
4	Screw-in adapter PR 6051/21S (1.4301; can be used in combination with base plate PR 6051/12S)	500 kg...5 t	9405 360 51212
5	Screw-in adapter PR 6051/22S (1.4301; can be used in combination with base plate PR 6051/12S)	10 t	9405 360 51222

11.2 Connecting cables

To connect the junction box to the weighing electronics, we recommend using the following connecting cables:

No.	Description	Order no.
1	PR 6135/xx	9405 361 35xx2
2	PR 6135/01A (armored)	9405 361 35019
3	PR 6136/xx (for installation inside the explosion-hazarded area)	9405 361 36xx1
4	PR 6136/01A (armored, for installation inside the explosion-hazarded area)	9405 361 36019

11.3 Cable junction boxes

We recommend using the following junction boxes:

No.	Description	Order no.
1	PR 6130/04 (aluminum, 1–4 load cells, IP67; not for PR 6251/..LA)	9405 361 30044
2	PR 6130/08 (polycarbonate, 1–8 load cells, IP66; not for PR 6251/..LA)	9405 361 30084
3	PR 6130/34Sa (1.4301, 1–4 load cells, IP68, IP69, verifiable; not for PR 6251/..LA)	9405 361 30344
4	PR 6130/35S (1.4301, 1–4 load cells, IP68, IP69, verifiable; not for PR 6251/..LA)	9405 361 30354
5	PR 6130/38S (1.4404, 1–8 load cells, IP68, IP69, verifiable; not for PR 6251/..LA)	9405 361 30384
6	PR 6130/64Sa (1.4301, 1–4 load cells, IP68, IP69, verifiable, ATEX, IECEx, FM; not for PR 6251/. LA)	9405 361 30644

No.	Description	Order no.
7	PR 6130/65S (1.4301, 1–4 load cells, IP68, IP69, verifiable, ATEX, IECEx, FM; not for PR 6251/. LA)	9405 361 30654
8	PR 6130/68S (1.4404, 1–8 load cells, IP68, IP69, verifiable, ATEX, IECEx, FM; not for PR 6251/. LA)	9405 361 30684

12 Certificates/safety instructions/control drawing

Ser. no.	Description	Document no.	see Chapter
1	EC-Type Examination Certificate	BVS 16 ATEX E 005	12.1
2	Certificate of Conformity	IECEX BVS 16.0005	12.2
3	EU-Type Examination Certificate	TÜV 03 ATEX 2301X	12.3
4	Certificate of Conformity	IECEX TUN 17.0025X	12.4
5	Manufacturer's Certificate	MIN16ATEX001X	12.5
6	Certificate of Conformity FM	FM17CA0138 FM17US0276	12.6 12.7
7	Control drawing FM	4012 101 5688	12.8
8	EU-Declaration of Conformity	MEU17031	12.9
9	Certificate of Conformity TR CU 020	RU Д-DE.A301.B.05345	12.10

12.1 BVS 16 ATEX E 005



(1) **EG-Baumusterprüfbescheinigung**

(2) Geräte und Schutzsysteme zur bestimmungsgemäßen Verwendung in explosionsgefährdeten Bereichen - Richtlinie 94/9/EG

(3) Nr. der EG-Baumusterprüfbescheinigung: **BVS 16 ATEX E 005**

(4) Gerät: **Wägezelle Typ PR62**/**E**

(5) Hersteller: **Sartorius Mechatronics T&H GmbH**

(6) Anschrift: **Meiendorfer Straße 205, 22145 Hamburg**

(7) Die Bauart dieses Gerätes sowie die verschiedenen zulässigen Ausführungen sind in der Anlage zu dieser Baumusterprüfbescheinigung festgelegt.

(8) Die Zertifizierungsstelle der DEKRA EXAM GmbH, benannte Stelle Nr. 0158 gemäß Artikel 9 der Richtlinie 94/9/EG des Europäischen Parlaments und des Rates vom 23. März 1994, bescheinigt, dass das Gerät die grundlegenden Sicherheits- und Gesundheitsanforderungen für die Konzeption und den Bau von Geräten und Schutzsystemen zur bestimmungsgemäßen Verwendung in explosionsgefährdeten Bereichen gemäß Anhang II der Richtlinie erfüllt. Die Ergebnisse der Prüfung sind in dem Prüfprotokoll BVS PP 16.2012 EG niedergelegt.

(9) Die grundlegenden Sicherheits- und Gesundheitsanforderungen werden erfüllt durch Übereinstimmung mit

EN 60079-0:2012 + A11:2013 Allgemeine Anforderungen
EN 60079-11:2012 Eigensicherheit „I“

(10) Falls das Zeichen „X“ hinter der Bescheinigungsnummer steht, wird in der Anlage zu dieser Bescheinigung auf besondere Bedingungen für die sichere Anwendung des Gerätes hingewiesen.

(11) Diese EG-Baumusterprüfbescheinigung bezieht sich nur auf die Konzeption und die Baumusterprüfung des beschriebenen Gerätes in Übereinstimmung mit der Richtlinie 94/9/EG. Für Herstellung und Inverkehrbringen des Gerätes sind weitere Anforderungen der Richtlinie zu erfüllen, die nicht durch diese Bescheinigung abgedeckt sind.

(12) Die Kennzeichnung des Gerätes muss die folgenden Angaben enthalten:

Ex II 1G Ex ia IIC T6 Ga

DEKRA EXAM GmbH
Bochum, den 20.01.2016



Zertifizierungsstelle



Fachbereich

Seite 1 von 2 zu BVS 16 ATEX E 005
Dieses Zertifikat darf nur vollständig und unverändert weiterverbreitet werden.

DEKRA EXAM GmbH, Dinnendahlstraße 9, 44809 Bochum, Deutschland
Telefon +49.234.3696-105, Telefax +49.234.3696-110, zs-exam@dekra.com



(13) Anlage zur

(14) **EG-Baumusterprüfbescheinigung
BVS 16 ATEX E 005**

(15) 15.1 Gegenstand und Typ

Wägezelle Typ PR62**/**E

Anstelle der *** werden in der vollständigen Benennung Buchstaben und Ziffern eingefügt, die unterschiedliche Typen kennzeichnen:

Wägezelle Typ PR62 * * / * * E

Unterschiedliche Ausführungen (01, 02, 11, 12, 21, 41, 46, 51, 61), die sich elektrisch und / oder mechanisch unterscheiden

Laststufe (nicht Ex-relevant, nur für Informationszwecke)

15.2 Beschreibung

Die Wägezellen dienen zur Umwandlung von Kraft in ein elektrisches Signal. Die Zellen haben ein Metallgehäuse mit eingebauten Dehnungsmessstreifen. Der elektrische Anschluss erfolgt über eine fest angeschlossene Leitung. Die Zellen sind „einfache elektrische Betriebsmittel“.

15.3 Kenngrößen

Spannung	U _i	DC	25	V
Strom	I _i		160	mA
Leistung	P _i		2	W
Umgebungstemperaturbereich	T _a		-30 °C bis +55 °C	

(16) Prüfprotokoll

BVS PP 16.2012 EG, Stand 20.01.2016

(17) Besondere Bedingungen für die sichere Anwendung

Keine

Seite 2 von 2 zu BVS 16 ATEX E 005
Dieses Zertifikat darf nur vollständig und unverändert weiterverbreitet werden.

DEKRA EXAM GmbH, Dinnendahlstraße 9, 44809 Bochum, Deutschland
Telefon +49.234.3696-105, Telefax +49.234.3696-110, zs-exam@dekra.com











Translation EC-Type Examination Certificate

(1) Equipment and protective systems intended for use in potentially explosive atmospheres - Directive 94/9/EC

(2) No. of EC-Type Examination Certificate: **BVS 16 ATEX E 005**

(3) Equipment: **Load cell type PR62**/*E**

(4) Manufacturer: **Sartorius Mechatronics T&H GmbH**

(5) Address: **Meiendorfer Straße 205, 22145 Hamburg, Germany**

(6) The design and construction of this equipment and any acceptable variation thereto are specified in the appendix to this type examination certificate.

(7) The certification body of DEKRA EXAM GmbH, notified body no. 0158 in accordance with Article 9 of the Directive 94/9/EC of the European Parliament and the Council of 23 March 1994, certifies that this equipment has been found to comply with the Essential Health and Safety Requirements relating to the design and construction of equipment and protective systems intended for use in potentially explosive atmospheres, given in Annex II to the Directive. The examination and test results are recorded in the Test and Assessment Report BVS PP 16.2012 EG.

(8) The Essential Health and Safety Requirements are assured by compliance with:

EN 60079-0:2012 + A11:2013 General requirements
EN 60079-11:2012 Intrinsic Safety "i"

(9) If the sign "X" is placed after the certificate number, it indicates that the equipment is subject to special conditions for safe use specified in the appendix to this certificate.

(10) This EC-Type Examination Certificate relates only to the design, examination and tests of the specified equipment in accordance to Directive 94/9/EC. Further requirements of the Directive apply to the manufacturing process and supply of this equipment. These are not covered by this certificate.

(11) The marking of the equipment shall include the following:

 **II 1G Ex ia IIC T6 Ga**

DEKRA EXAM GmbH
Bochum, dated 2016-01-20

Signed: Dr. Eickhoff

Certification body

Signed: Dr. Wittler

Special services unit

Page 1 of 2 of BVS 16 ATEX E 005
This certificate may only be reproduced in its entirety and without any change.

DEKRA EXAM GmbH, Dinnendahlstrasse 9, 44809 Bochum, Germany,
telephone +49.234.3696-105, Fax +49.234.3696-110, zs-exam@dekra.com



(13) Appendix to

(14) **EC-Type Examination Certificate**
BVS 16 ATEX E 005

(15) 15.1 Subject and type

Load cell type PR62**/**E

Instead of the *** in the complete denomination letters and numerals will be inserted which characterize different cell types:

Load cell type PR62

*	*
---	---

 /

*	*
---	---

 E

Different versions (01, 02, 11, 12, 21, 41, 46, 51, 61) which differ electrically and / or mechanically

Load level (not Ex relevant, for information purposes only)

15.2 Description

The load cells are used for converting a load into an electrical signal. The cells have a metal enclosure with inside fixed resistance strain gauges. The electrical connection is carried out by a permanently connected cable. The cells are "simple apparatus".

15.3 Parameters

Voltage	U _i	DC	25	V
Current	I _i		160	mA
Power	P _i		2	W
Ambient temperature range	T _a		-30 °C up to +55 °C	

(16) Test and Assessment Report

BVS PP 16.2012 EG as of 2016-01-20

(17) Special conditions for safe use

None

We confirm the correctness of the translation from the German original.
In the case of arbitration only the German wording shall be valid and binding.

DEKRA EXAM GmbH
44809 Bochum, 2016-01-20
BVS-/Hil/Schu/Mu A 20150360

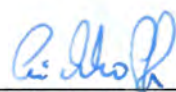

 Certification body





 Special services unit



Page 2 of 2 of BVS 16 ATEX E 005
This certificate may only be reproduced in its entirety and without any change.

DEKRA EXAM GmbH, Dinnendahlstrasse 9, 44809 Bochum, Germany,
telephone +49.234.3696-105, Fax +49.234.3696-110, zs-exam@dekra.com

12.2 IECEx BVS 16.0005

		<h2>IECEX Certificate of Conformity</h2>	
INTERNATIONAL ELECTROTECHNICAL COMMISSION IEC Certification Scheme for Explosive Atmospheres <small>for rules and details of the IECEx Scheme visit www.iecex.com</small>			
Certificate No.:	IECEX BVS 16.0005	Issue No.:	1
Status:	Current	Certificate history: Issue No. 1 (2017-7-6) Issue No. 0 (2016-1-21)	
Date of Issue:	2017-07-06	Page 1 of 4	
Applicant:	Minebea Intec GmbH Meiendorfer Straße 205 22145 Hamburg Germany		
Equipment: Optional accessory:	Load cell type PR 62**/*E		
Type of Protection:	Equipment protection by intrinsic safety "i"		
Marking:	Ex ia IIC T6 Ga		
Approved for issue on behalf of the IECEx Certification Body:	Dr. F. Eickhoff		
Position:	Deputy Head of Certification Body		
Signature: (for printed version)			
Date:	2017-07-06		
1. This certificate and schedule may only be reproduced in full. 2. This certificate is not transferable and remains the property of the issuing body. 3. The Status and authenticity of this certificate may be verified by visiting the Official IECEx Website.			
Certificate issued by:			
DEKRA EXAM GmbH Dinnendahlstrasse 9 44809 Bochum Germany		On the safe side.	

		IECEX Certificate of Conformity
Certificate No.:	IECEX BVS 16.0005	
Date of Issue:	2017-07-06	Issue No.: 1
		Page 2 of 4
Manufacturer:	Minebea Intec GmbH Meiendorfer Straße 205 22145 Hamburg Germany	
Additional Manufacturing location(s):		
<p>This certificate is issued as verification that a sample(s), representative of production, was assessed and tested and found to comply with the IEC Standard list below and that the manufacturer's quality system, relating to the Ex products covered by this certificate, was assessed and found to comply with the IECEx Quality system requirements. This certificate is granted subject to the conditions as set out in IECEx Scheme Rules, IECEx 02 and Operational Documents as amended.</p>		
STANDARDS: The electrical apparatus and any acceptable variations to it specified in the schedule of this certificate and the identified documents, was found to comply with the following standards:		
IEC 60079-0 : 2011 Edition: 6.0	Explosive atmospheres - Part 0: General requirements	
IEC 60079-11 : 2011 Edition: 6.0	Explosive atmospheres - Part 11: Equipment protection by intrinsic safety "i"	
<p><i>This Certificate does not indicate compliance with electrical safety and performance requirements other than those expressly included in the Standards listed above.</i></p>		
TEST & ASSESSMENT REPORTS: A sample(s) of the equipment listed has successfully met the examination and test requirements as recorded in:		
<u>Test Report:</u> DE/BVS/ExTR16.0007/00		
<u>Quality Assessment Report:</u> DE/PTB/QAR13.0007/02		

		IECEX Certificate of Conformity
Certificate No.:	IECEX BVS 16.0005	
Date of Issue:	2017-07-06	Issue No.: 1
		Page 3 of 4
Schedule		
EQUIPMENT: <i>Equipment and systems covered by this certificate are as follows:</i>		
General product information:		
The load cells are used for converting a load into an electrical signal. The cells have a metal enclosure with inside fixed resistance strain gauges. The electrical connection is carried out by a permanently connected cable. The cells are "simple apparatus".		
Technical parameters		
Voltage	Ui	DC 25 V
Current	Ii	160 mA
Power	Pi	2 W
Ambient temperature range	Ta	-30 °C up to +55 °C
Type Designation		
See Annex		
SPECIFIC CONDITIONS OF USE: NO		

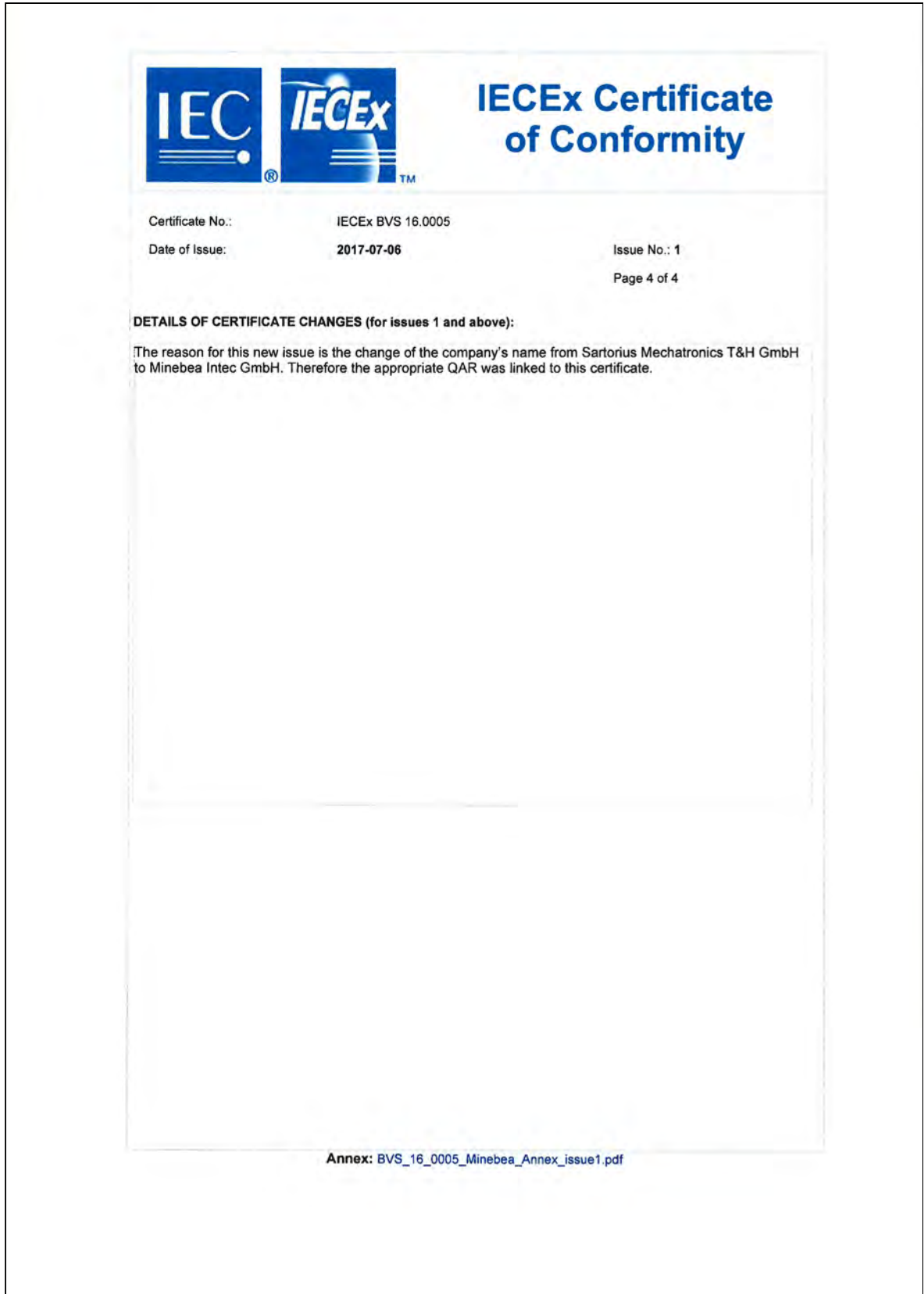

12.3 TÜV 03 ATEX 2301X



(1) **EU-Baumusterprüfbescheinigung**

(2) Geräte und Schutzsysteme zur bestimmungsgemäßen Verwendung in explosionsgefährdeten Bereichen, Richtlinie 2014/34/EU



(3) **Bescheinigungsnummer:** TÜV 03 ATEX 2301 X **Ausgabe:** 00

(4) für das Produkt: Wägezellen Typ PR 62.../.. und MP76/...

(5) des Herstellers: Minebea Intec GmbH

(6) Anschrift: Meiendorfer Str. 205 A, 22145 Hamburg

Auftragsnummer: 8000475687

Ausstellungsdatum: 14.11.2017

(7) Die Bauart dieses Produktes sowie die verschiedenen zulässigen Ausführungen sind in der Anlage und den darin aufgeführten Unterlagen zu dieser EU-Baumusterprüfbescheinigung festgelegt.

(8) Die TÜV NORD CERT GmbH bescheinigt als notifizierte Stelle Nr. 0044 nach Artikel 17 der Richtlinie 2014/34/EU des Europäischen Parlaments und des Rates vom 26. Februar 2014 die Erfüllung der wesentlichen Gesundheits- und Sicherheitsanforderungen für die Konzeption und den Bau dieses Produktes zur bestimmungsgemäßen Verwendung in explosionsgefährdeten Bereichen gemäß Anhang II der Richtlinie.
Die Ergebnisse der Prüfung sind in dem vertraulichen ATEX Prüfungsbericht Nr. 17 203 206448 festgelegt.

9) Die wesentlichen Gesundheits- und Sicherheitsanforderungen werden erfüllt durch Übereinstimmung mit:
EN 60079-0:2012+A11:2013 EN 60079-31:2014
ausgenommen die unter Abschnitt 18 der Anlage gelisteten Anforderungen.

(10) Falls das Zeichen "X" hinter der Bescheinigungsnummer steht, wird auf die Besonderen Bedingungen für die Verwendung des Produktes in der Anlage zu dieser Bescheinigung hingewiesen.

(11) Diese EU-Baumusterprüfbescheinigung bezieht sich nur auf Konzeption und Prüfung des festgelegten Produktes. Weitere Anforderungen dieser Richtlinie gelten für die Herstellung und das Bereitstellen dieses Produktes. Diese Anforderungen werden nicht durch diese Bescheinigung abgedeckt.

(12) Die Kennzeichnung des Produktes muss die folgenden Angaben enthalten:

 II 1 D Ex ta IIIC T160 °C Da

TÜV NORD CERT GmbH, Langemarkstraße 20, 45141 Essen, notifiziert durch die Zentralstelle der Länder für Sicherheitstechnik (ZLS), Ident. Nr. 0044, Rechtsnachfolger der TÜV NORD CERT GmbH & Co. KG Ident. Nr. 0032

Der Leiter der notifizierten Stelle

Meyer

Geschäftsstelle Hannover, Am TÜV 1, 30519 Hannover, Tel. +49 511 998-61455, Fax +49 511 998-61590

Diese Bescheinigung darf nur unverändert weiterverbreitet werden.
Auszüge oder Änderungen bedürfen der Genehmigung der TÜV NORD CERT GmbH

P17-F-001 Rev. 01/014.16 Seite 1/3

(13) **ANLAGE**(14) **EU-Baumusterprüfbescheinigung Nr. TÜV 03 ATEX 2301 X Ausgabe 00**

(15) Beschreibung des Produktes

Die Wägezellen Typen PR62../... und MP76/... gemäß der unten aufgeführten Tabelle dienen zur Messung von Kräften mittels einer DMS Brücke mit Kompensations- und Abgleichwiderständen. Die Gehäuse der Wägezellen sowie die eingesetzten Membranen bestehen aus Edelstahl. Alle Gehäuseteile und die Membranen sind gasdicht verschweißt.

Die Wägezellen dürfen in durch Staub explosionsgefährdeten Bereichen für EPL Da-Betriebsmittel bzw. EPL Db-Betriebsmittel installiert werden.

Der zulässige Umgebungstemperaturbereich beträgt -20 °C ... 55°C.

Auflistung der Typen und Gehäuseformen

Typen	Gehäuseform
PR 6201/...	Zylinder
PR 6202/...	Zylinder
PR 6203/...	Zylinder
PR 6221/...	Zylinder
PR 6211/...	Kreisplatte
PR 6212/...	Kreisplatte
PR 6251/...	Kreisplatte
PR 6261/...	Kreisplatte
PR 6241/...	S-Form
PR 6246/...	S-Form
MP 76/...	S-Form

Elektrische Daten

Versorgungs- und
Signalstromkreis
(fest angeschlossenes Kabel)

nur zum Anschluss an einen bescheinigten
eigensicheren Stromkreis

Höchstwert:

$P_i = 2 \text{ W}$

Die wirksame innere Induktivität und Kapazität sind vernachlässigbar klein.

Verwendung als EPL Da-Betriebsmittel

Schutzniveau des Stromkreises: ia

Verwendung als EPL Db-Betriebsmittel

Schutzniveau des Stromkreises: ia oder ib

(16) Zeichnungen und Dokumente sind im ATEX Prüfungsbericht Nr. 17 203 206448 aufgelistet.



Anlage zur EU-Baumusterprüfbescheinigung Nr. TÜV 03 ATEX 2103 X Ausgabe 00

(17) Besondere Bedingungen für die Verwendung

1. Die freien Leitungsenden der Anschlüsse sind außerhalb des explosionsgefährdeten Bereiches oder in einem geeigneten, für den Einsatz in durch Staub explosionsgefährdeten Bereichen bescheinigten Klemmenkasten zu verdrahten.

2. Der Anschluss von nichteigensicheren Stromkreisen

- mit einer sicheren Begrenzung der verfügbaren Leistung auf 2W und
 - einer sicheren galvanischen Trennung vom Erdpotential (für Wägezellen ohne zusätzlichen Erdanschluss erforderlich)
- an die Wägezellen mit EPL Db ist zulässig.

3. Die Wägezellen sind so zu errichten, dass die Gehäuse sicher mit Erdpotential verbunden sind (z. B. über die Erdungsklemme; die Betriebsanleitung des Herstellers ist zu beachten).

(18) Wesentliche Gesundheits- und Sicherheitsanforderungen

keine zusätzlichen

- Ende der Bescheinigung -

Translation

(1) **EU-Type Examination Certificate**

(2) Equipment and protective systems intended for use in potentially explosive atmospheres, **Directive 2014/34/EU**

(3) **Certificate Number** TÜV 03 ATEX 2301 X **issue:** 00

(4) for the product: Load cell type PR 62../... and MP76/...

(5) of the manufacturer: Minebea Intec GmbH
 (6) Address: Meiendorfer Str. 205 A, 22145 Hamburg

Order number: 8000475687

Date of issue: 2017-11-14

- (7) The design of this product and any acceptable variation thereto are specified in the schedule to this EU-Type Examination Certificate and the documents therein referred to.
- (8) The TÜV NORD CERT GmbH, Notified Body No. 0044, in accordance with Article 17 of the Directive 2014/34/EU of the European Parliament and the Council of 26 February 2014, certifies that this product has been found to comply with the Essential Health and Safety Requirements relating to the design and construction of products intended for use in potentially explosive atmospheres given in Annex II to the Directive.
 The examination and test results are recorded in the confidential ATEX Assessment Report No. 17 203 206448.
- (9) Compliance with the Essential Health and Safety Requirements has been assured by compliance with:
 EN 60079-0:2012+A11:2013 EN 60079-31:2012
 except in respect of those requirements listed at item 18 of the schedule.
- (10) If the sign "X" is placed after the certificate number, it indicates that the product is subject to the Specific Conditions for Use specified in the schedule to this certificate.
- 11) This EU-Type Examination Certificate relates only to the design, and construction of the specified product. Further requirements of the Directive apply to the manufacturing process and supply of this equipment. These are not covered by this certificate.
- (12) The marking of the product shall include the following:

 II 1 D Ex ta IIIC T160 °C Da

TÜV NORD CERT GmbH, Langemarckstraße 20, 45141 Essen, notified by the central office of the countries for safety engineering (ZLS), Ident. Nr. 0044, legal successor of the TÜV NORD CERT GmbH & Co. KG Ident. Nr. 0032

The head of the notified body

 Meyer

Hanover office, Am TÜV 1, 30519 Hannover, Tel. +49 511 998-61455, Fax +49 511 998-61590

This certificate may only be reproduced without any change, schedule included.
 Excerpts or changes shall be allowed by the TÜV NORD CERT GmbH

(13) **SCHEDULE**(14) **EU-Type Examination Certificate No. TÜV 03 ATEX 2301 X issue 00**

(15) Description of product

The load cells type PR62../... and MP76../... according to the table mentioned below are used for measuring forces by means of a strain gauge with resistors for compensation and adjustment.

The housings of the load cells as well as the used membranes consist of stainless steel. All parts of the housing and the membranes are welded gas-tight.

The load cells are allowed to be installed in explosion hazardous areas caused by dust for EPL Da apparatus resp. for EPL Db apparatus.

The permissible ambient temperature range is -20 °C ... 55 °C.

Listing of types and shape of housings

Types	Shape of housing
PR 6201/...	Cylinder
PR 6202/...	Cylinder
PR 6203/...	Cylinder
PR 6221/...	Cylinder
PR 6211/...	Circle plate
PR 6212/...	Circle plate
PR 6251/...	Circle plate
PR 6261/...	Circle plate
PR 6241/...	S-shape
PR 6246/...	S-shape
MP 76/...	S-shape

Supply- and
signal circuit
(Cable connected fixed)

only for connection to a certified
intrinsically safe circuit

Maximum value:

$P_i = 2 \text{ W}$

The effective internal inductance and capacitance
are negligibly small.

Use as EPL Da apparatus

Level of protection of the circuit: ia

Use as EPL Db apparatus

Level of protection of the circuit: ia or ib

(16) Drawings and documents are listed in the ATEX Assessment Report No. 17 203 206448



Schedule to EU-Type Examination Certificate No. TÜV 03 ATEX 2301 X issue 00

(17) Specific Conditions for Use

1. The free cable ends of the connections have to be wired outside of the explosion hazardous area or in a suitable terminal box, suitably certified for the application in explosion hazardous areas caused by dust.

2. The connection of non-intrinsically safe circuits
- with a safe limitation of the available power of 2 W and
- a safe galvanic separation from earth potential (necessary for load cells without an additional earth connection)
to the load cells of EPL Db is permissible.

3. The load cells have to be installed in such a way, that the housings are safely connected with earth potential (e. g. via the earth terminal; observe manual of the manufacturer).



(18) Essential Health and Safety Requirements



no additional ones

- End of Certificate -

12.4 IECEx TUN 17.0025X

		IECEX Certificate of Conformity	
INTERNATIONAL ELECTROTECHNICAL COMMISSION IEC Certification Scheme for Explosive Atmospheres <small>for rules and details of the IECEx Scheme visit www.iecex.com</small>			
Certificate No.:	IECEX TUN 17.0025X	issue No.:0	Certificate history:
Status:	Current		
Date of Issue:	2017-11-14	Page 1 of 3	
Applicant:	Minebea Intec GmbH Meiendorfer Str. 205 22145 Hamburg Germany		
Equipment: <i>Optional accessory:</i>	Weighing cells type PR 62.. /... and MP76/...		
Type of Protection:	Equipment dust ignition protection by enclosure "t"		
Marking:	Ex ta IIIC T160°C Da		
Approved for issue on behalf of the IECEx Certification Body:	Andreas Meyer		
Position:	Head of IECEx Certification Body		
Signature: <i>(for printed version)</i>			
Date:			
1. This certificate and schedule may only be reproduced in full. 2. This certificate is not transferable and remains the property of the issuing body. 3. The Status and authenticity of this certificate may be verified by visiting the Official IECEx Website .			
Certificate issued by:			
TÜV NORD CERT GmbH Hanover Office Am TÜV 1, 30519 Hannover Germany			

		IECEX Certificate of Conformity
Certificate No.:	IECEX TUN 17.0025X	Issue No.: 0
Date of Issue:	2017-11-14	Page 2 of 3
Manufacturer:	Minebea Intec GmbH Meiendorfer Str. 205 22145 Hamburg Germany	
Additional Manufacturing location(s):		
<p>This certificate is issued as verification that a sample(s), representative of production, was assessed and tested and found to comply with the IEC Standard list below and that the manufacturer's quality system, relating to the Ex products covered by this certificate, was assessed and found to comply with the IECEX Quality system requirements. This certificate is granted subject to the conditions as set out in IECEX Scheme Rules. IECEX 02 and Operational Documents as amended.</p>		
STANDARDS: The electrical apparatus and any acceptable variations to it specified in the schedule of this certificate and the identified documents, was found to comply with the following standards:		
IEC 60079-0 : 2011 Edition: 6.0	Explosive atmospheres - Part 0: General requirements	
IEC 60079-31 : 2013 Edition: 2	Explosive atmospheres - Part 31: Equipment dust ignition protection by enclosure "I"	
<p><i>This Certificate does not indicate compliance with electrical safety and performance requirements other than those expressly included in the Standards listed above.</i></p>		
TEST & ASSESSMENT REPORTS: A sample(s) of the equipment listed has successfully met the examination and test requirements as recorded in		
<u>Test Report:</u> DE/TUN/EXTR17.0023/00		
<u>Quality Assessment Report:</u> DE/PTB/QAR13.0007/02		

		IECEX Certificate of Conformity
Certificate No.:	IECEX TUN 17.0025X	
Date of Issue:	2017-11-14	Issue No.: 0
		Page 3 of 3
Schedule		
EQUIPMENT: <i>Equipment and systems covered by this certificate are as follows:</i>		
<p>The load cells type PR62./... and MP76/... according to the table mentioned below are used for measuring forces by means of a strain gauge with resistors for compensation and adjustment. The housings of the load cells as well as the used membranes consist of stainless steel. All parts of the housing and the membranes are welded gas-tight. The load cells are allowed to be installed in explosion hazardous areas caused by dust for EPL Da apparatus resp. for EPL Db apparatus. The permissible ambient temperature range is -20 °C ... +55 °C.</p> <p>See attachment for further details.</p>		
SPECIFIC CONDITIONS OF USE: YES as shown below:		
<ol style="list-style-type: none">1.The free cable ends of the connections have to be wired outside of the explosion hazardous area or in a suitable terminal box, certified for the application in explosion hazardous areas caused by dust.2.The connection of non intrinsically safe circuits - with a safe limitation of the available power of 2W and - a safe galvanic separation from earth potential (necessary for load cells without an additional earth connection) to the load cells of the category 2 is permissible.3.The load cells have to be installed in such a way, that the housings are connected with earth potential.		
Annex: _Attachment_load cells TUN 17.0025 X (2).pdf		

TÜV NORD CERT GmbH
 Hanover Office
 Am TÜV 1
 30519 Hannover
 Germany



Page 1 of 1
 Attachment to IECEx TUN 17.0025 X issue 00

The load cells type PR62./... and MP76/... according to the table mentioned below are used for measuring forces by means of a strain gauge with resistors for compensation and adjustment. The housings of the load cells as well as the used membranes consist of stainless steel. All parts of the housing and the membranes are welded gas-tight. The load cells are allowed to be installed in explosion hazardous areas caused by dust for category 1 apparatus resp. for category 2 apparatus. The permissible ambient temperature range is -20 °C ... 55 °C.

Listing of types and shape of housings

Types	Shape of housing
PR 6201/...	Cylinder
PR 6202/...	Cylinder
PR 6203/...	Cylinder
PR 6221/...	Cylinder
PR 6211/...	Circle plate
PR 6212/...	Circle plate
PR 6251/...	Circle plate
PR 6261/...	Circle plate
PR 6241/...	S-shape
PR 6246/...	S-shape
MP 76/...	S-shape

Supply- and signal circuit
 (Cable connected fixed)

only for connection to a certified intrinsically safe circuit

Maximum value:
 $P_i = 2 \text{ W}$

The effective internal inductance and capacitance are negligibly small.

Use as category 1 apparatus

Level of protection of the circuit: ia

Use as category 2 apparatus

Level of protection of the circuit: ia or ib

Specific Conditions of Use

1. The free cable ends of the connections have to be wired outside of the explosion hazardous area or in a suitable terminal box, suitably certified for the application in explosion hazardous areas caused by dust.
2. The connection of non intrinsically safe circuits
 - with a safe limitation of the available power of 2 W and
 - a safe galvanic separation from earth potential (necessary for load cells without an additional earth connection)
 to the load cells of the category 2 is permissible.
3. The load cells have to be installed in such a way, that the housings are safely connected with earth potential (e. g. via the earth terminal; observe manual of the manufacturer).

12.5 MIN16ATEX001X



Herstellerbescheinigung Manufacturer's certificate



Nummer
Number

MIN16ATEX001X

Hersteller
Manufacturer

Minebea Intec GmbH
Meiendorfer Straße 205A
22145 Hamburg, Germany

erklärt in alleiniger Verantwortung, dass das Produkt
declares under sole responsibility that the product

Geräteart
Device type

Wägezelle
Load cell

Baureihe
Type series

PR 6201, PR 6202, PR 6203, PR 6207, PR 6211 D1(500kg-10t), PR 6212, PR 6221, PR 6241,
PR 6246, PR 6251, PR 6261 | (ohne Typ / without type LA or LT)

auf das sich diese Bescheinigung bezieht, mit der/den folgenden Norm(en) oder normativen
Dokument(en) übereinstimmt (siehe Seite 2) gemäß den Bestimmungen der „Richtlinie 2014/34/EU
des Europäischen Parlaments und des Rates vom 26. Februar 2014 zur Harmonisierung der
Rechtsvorschriften der Mitgliedstaaten für Geräte und Schutzsysteme zur bestimmungsgemäßen
Verwendung in explosionsgefährdeten Bereichen“. Das Produkt wird wie folgt gekennzeichnet:
*to which this certification relates is in conformity with the following standard(s) or other normative
document(s) (see page 2) pursuant to the provisions of the "Directive 2014/34/EU of the European
Parliament and of the Council of 26 February 2014 on the harmonisation of the laws of the Member
States relating to equipment and protective systems intended for use in potentially explosive
atmospheres". This product is labelled as follows:*

Kennzeichnung
Marking

II 3G Ex nA IIC T6 Gc
II 3D Ex tc IIIC T85°C Dc
MIN16ATEX001X

Minebea Intec GmbH
Hamburg, 14.07.2022

Dr. K. Sommer
Managing Director

Dr. A. Böttger
CTO

Torben Hiller
Ex Approval Manager

Diese Erklärung bescheinigt die Übereinstimmung mit den genannten EU-Richtlinien, ist jedoch keine Zusicherung von
Eigenschaften. Bei einer mit uns nicht abgestimmten Änderung des Produktes verliert diese Erklärung ihre Gültigkeit. Die
Sicherheitshinweise der zugehörigen Produktdokumentation sind zu beachten.
*This declaration certifies conformity with the above mentioned EC Directives, but does not guarantee product attributes.
Unauthorized product modifications make this declaration invalid. The safety information in the associated product
documentation must be observed.*



Herstellerbescheinigung Manufacturer's certificate



Die grundlegenden Sicherheits- und Gesundheitsanforderungen werden erfüllt durch Übereinstimmung mit:

Compliance with the Essential Health and Safety Requirements has been assured by compliance with:

Normen Standards

EN IEC 60079-0:2018

Explosionsgefährdete Bereiche – Teil 0: Geräte – Allgemeine Anforderungen
Explosive atmospheres – Part 0: Equipment – General requirements

EN 60079-15:2010

Explosionsfähige Atmosphäre – Teil 15: Geräteschutz durch Zündschutzart „n“
Explosive atmospheres – Part 15: Equipment protection by type of protection „n“

EN 60079-31:2014

Explosionsfähige Atmosphäre – Teil 31: Geräte-Staubexplosionsschutz durch Gehäuse „t“
Explosive atmospheres – Part 31: Equipment dust ignition protection by enclosure „t“

Diese Bescheinigung wurde auf Basis des folgenden Prüfberichts erstellt:

This certificate was drawn on the basis of the following test report:

Prüfbericht Test Report

MTR17001

Minebea Intec GmbH, Hamburg, Germany

Sicherheitshinweise Safety instructions

949905947901

Umgebungstemperatur Ambient temperature

-30°C ... +55°C

IP-Schutz IP protection

IP6X

Für diese Produkt gelten folgende besonderen Bedingungen für den sicheren Gebrauch:

For this product the following special conditions for safe use apply:

besondere Bedingungen special Conditions

Für Anwendungen in Umgebungen mit brennbaren Stäuben ist eine elektrostatische Aufladung zu vermeiden.

For application in environments with combustible dust, electrostatic charging shall be avoided.

Bei Verwendung der Zündschutzart "Ex nA" ist eine Transientenschutzeinrichtung vorzusehen welche einen Maximalwert von 140% des Spitzenspannungswertes von 85V sicherstellt.

When applied in type of protection non sparking "Ex nA", a transient protection device shall be set at a level not exceeding 140% of the peak rated voltage value of 85 V.

12.6 FM17CA0138

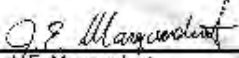
CERTIFICATE OF CONFORMITY		
1. HAZARDOUS LOCATION ELECTRICAL EQUIPMENT PER CANADIAN REQUIREMENTS		
2. Certificate No:	FM17CA0138	
3. Equipment: (Type Reference and Name)	Model PR 6201, PR 6202, PR 6203, PR 6211, PR 6212, PR 6221, PR 6241, PR 6246, PR 6251, PR 6261 Load Cells	
4. Name of Listing Company:	Minebea Intec GmbH	
5. Address of Listing Company:	Meien dorfer Str. 205A 22145 Hamburg Germany	
6. The examination and test results are recorded in confidential report number: 3053046 dated 22 nd July 2014		
7. FM Approvals LLC, certifies that the equipment described has been found to comply with the following Approval standards and other documents: CAN/CSA-C22.2 No. 213: 2013, CAN-C22.2 No. 157-92: 2012, CSA-C22.2 No. 1010.1: 2004, CAN/CSA-C22.2 No. 25: 2009		
8. If the sign 'X' is placed after the certificate number, it indicates that the equipment is subject to specific conditions of use specified in the schedule to this certificate.		
9. This certificate relates to the design, examination and testing of the products specified herein. The FM Approvals surveillance audit program has further determined that the manufacturing processes and quality control procedures in place are satisfactory to manufacture the product as examined, tested and Approved.		
10. Equipment Ratings: Intrinsically safe (Entity) for use in Class I, II and III Division 1, Groups A, B, C, D, E, F and G indoor and outdoor Hazardous Locations, Temperature Class T4A Ta= -40°C to +70°C and T5 Ta= -40°C to +55°C when installed per Control Drawing 4012 101 5688. Nonincendive (NIFW) for use in Class I, Division 2, Groups A, B, C, and D indoor and outdoor Hazardous Locations, Temperature Class T4A Ta= -40°C to +70°C and T5 Ta= -40°C to +55°C when installed per Control Drawing 4012 101 5688.		
Certificate issued by:		
 J.E. Marquedant VP, Manager - Electrical Systems		30 July 2020 Date
To verify the availability of the Approved product, please refer to www.approvalsusa.com		
<u>THIS CERTIFICATE MAY ONLY BE REPRODUCED IN ITS ENTIRETY AND WITHOUT CHANGE</u>		
FM Approvals LLC, 1151 Boston-Providence Turnpike, Norwood, MA 02062 USA T: +1 (1) 781 762 4300 F: +1 (1) 781 762 9375 E-mail: information@fmapprovals.com www.fmapprovals.com		
F 349 (Mar 16)	Page 1 of 3	

<u>SCHEDULE</u>	
	
Canadian Certificate Of Conformity No: FM17CA0138	
Dust Ignition protected for Class II, III Division 2, Groups E, F and G indoor and outdoor Hazardous Locations, Temperature Class T4A Ta= -40°C to +70°C and T5 Ta= -40°C to +55°C when installed per Control Drawing 4012 101 5688	
11. The marking of the equipment shall include:	IS CL I, II, III, DIV 1, GP A,B,C,D,E,F,G Entity - 4012 101 5688 NI CL I, II, III, DIV 2, GP A,B,C,D, E, F, G - 4012 101 5688; NIFW T4A Ta= -40°C to 70°C; T5 Ta= -40°C to 55°C
12. Description of Equipment:	<p>General - The Model PR 62xx Series Load Cells are precision compression load cells designed to meet the specific requirements of a wide range of weighing installations.</p> <p>Construction - The Model PR 62xx Series Load Cells are constructed of welded stainless steel, hermetically sealed, and filled with inert gas.</p> <p>Ratings - The Model PR 62xx Series Load Cells are rated for an operating temperature range of -40°C to 70°C. Entity and Nonincendive Field Wiring parameters are as defined below.</p> <p>PR 62a/bc d e. Load Cell.</p> <p>Entity/Nonincendive Field Wiring Parameters: Ui = 25 V, li = 160 mA, Pi = 2 W; Ci= 0 µF, Li= 0 mH.</p> <p>a = 01, 02, 03, 11, 12, 21, 41, 46, 51, 61 b = up to three numbers denoting the maximum capacity (may be separated by a dot) c = Unit of measurement: blank or t d = Accuracy: up to three numbers or letters (may be separated by dots) e = Special: F or blank</p>
13. Specific Conditions of Use:	None
14. Test and Assessment Procedure and Conditions:	This Certificate has been issued in accordance with FM Approvals Canadian Certification Scheme.
15. Schedule Drawings	A copy of the technical documentation has been kept by FM Approvals.
16. Certificate History	Details of the supplements to this certificate are described below:
<u>THIS CERTIFICATE MAY ONLY BE REPRODUCED IN ITS ENTIRETY AND WITHOUT CHANGE</u>	
FM Approvals LLC, 1151 Boston-Providence Turnpike, Norwood, MA 02062 USA T: +1 (1) 781 762 4300 F: +1 (1) 781 762 9375 E-mail: information@fmapprovals.com www.fmapprovals.com	
F 348 (Mar 16)	Page 2 of 3

SCHEDULE

Canadian Certificate Of Conformity No: FM17CA0138

Date	Description
22 nd July 2014	Original Issue.
6 th October 2017	<u>Supplement 3:</u> Report Reference: – RR210028 dated 6 th October 2017. Description of the Change: Company name change from Sartorius Mechatronics T&H GmbH. Certificate reformed.
10 th November 2017	<u>Supplement 4:</u> Report Reference: – RR211742 dated 10 th November 2017. Description of the Change: Addition of option a = 03.
24 th October 2018	<u>Supplement 5:</u> Report Reference: – RR215447 dated 24 th October 2018 . Description of the Change: Update lower operating temperatures from -30°C to -40°C.
30 th July 2020	<u>Supplement 6:</u> Report Reference: – RR224030 dated 30 th July 2020. Description of the Change: Added load cell variation PR 6261.

THIS CERTIFICATE MAY ONLY BE REPRODUCED IN ITS ENTIRETY AND WITHOUT CHANGE

FM Approvals LLC, 1151 Boston-Providence Turnpike, Norwood, MA 02062 USA
 T: +1 (1) 781 762 4300 F: +1 (1) 781 762 9375 E-mail: information@fmaprovals.com www.fmaprovals.com

F 348 (Mar 16)

Page 3 of 3

12.7 FM17US0276



CERTIFICATE OF CONFORMITY

1. HAZARDOUS (CLASSIFIED) LOCATION ELECTRICAL EQUIPMENT PER US REQUIREMENTS
2. Certificate No: FM17US0276
3. Equipment: Model PR 6201, PR 6202, PR 6203, PR 6211, PR 6212, PR 6221, PR 6241, PR 6246, PR 6251, PR 6261 Load Cells
(Type Reference and Name)
4. Name of Listing Company: Minebea Intec GmbH
5. Address of Listing Company: Majendorfer Str. 205A
22145 Hamburg
Germany
6. The examination and test results are recorded in confidential report number:

3001200 dated 12th August 1999
7. FM Approvals LLC, certifies that the equipment described has been found to comply with the following Approval standards and other documents:

FM Class 3600:2018, FM Class 3610:2010, FM Class 3611:2004, FM Class 3810:2005
8. If the sign 'X' is placed after the certificate number, it indicates that the equipment is subject to specific conditions of use specified in the schedule to this certificate.
9. This certificate relates to the design, examination and testing of the products specified herein. The FM Approvals surveillance audit program has further determined that the manufacturing processes and quality control procedures in place are satisfactory to manufacture the product as examined, tested and Approved.
10. Equipment Ratings:

Intrinsically safe (Entity) for use in Class I, II and III Division 1, Groups A, B, C, D, E, F and G indoor and outdoor Hazardous (C classified) Locations, Temperature Class T4A Ta= -40°C to +70°C and T5 Ta= -40°C to +55°C when installed per Control Drawing 4012 101 5688.
Nonincendive (NIFW) for use in Class I, II and III Division 2, Groups A, B, C, D, E, F and G indoor and outdoor Hazardous (C classified) Locations, Temperature Class T4A Ta= -40°C to +70°C and T5 Ta= -40°C to +55°C when installed per Control Drawing 4012 101 5688.

Certificate issued by:

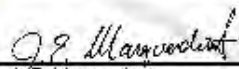

 J/E. Marquardt
 VP, Manager - Electrical Systems

 30 July 2020
 Date

To verify the availability of the Approved product, please refer to www.fmapprovals.com

THIS CERTIFICATE MAY ONLY BE REPRODUCED IN ITS ENTIRETY AND WITHOUT CHANGE

FM Approvals LLC, 1151 Boston-Providence Turnpike, Norwood, MA 02062 USA
 T: +1 (1) 781 762 4300 F: +1 (1) 781 762 9375 E-mail: inquiries@fmapprovals.com, www.fmapprovals.com

F 347 (Mar 16) Page 1 of 3

<u>SCHEDULE</u>	
	
US Certificate Of Conformity No: FM17US0276	
11.	<p>The marking of the equipment shall include:</p> <p>IS CL I, II, III, DIV 1, GP A,B,C,D,E,F,G Entity - 4012 101 5688 NI CL I, II, III, DIV 2, GP A,B,C,D,E,F,G - 4012 101 5688; NIFW T4A Ta= -40°C to 70°C; T5 Ta= -40°C to 55°C</p>
12.	<p>Description of Equipment:</p> <p>General - The Model PR 62xx Series Load Cells are precision compression load cells designed to meet the specific requirements of a wide range of weighing installations.</p> <p>Construction - The Model PR 62xx Series Load Cells are constructed of welded stainless steel, hermetically sealed, and filled with inert gas.</p> <p>Ratings - The Model PR 62xx Series Load Cells are rated for an operating temperature range of -40°C to 70°C. Entity and Nonincendive Field Wiring parameters are as defined below.</p> <p>PR 62a/bc d e. Load Cell.</p> <p>Entity/Nonincendive Field Wiring Parameters: Ui = 25 V, Ii = 160 mA, Pi = 2 W; Ci = 0 µF, Li = 0 mH.</p> <p>a = 01, 02, 03, 11, 12, 21, 41, 46, 51, 61 b = up to three numbers denoting the maximum capacity (may be separated by a dot) c = Unit of measurement: blank or t d = Accuracy: up to three numbers or letters (may be separated by dots) e = Special: F or blank</p>
13.	<p>Specific Conditions of Use:</p> <p>None</p>
14.	<p>Test and Assessment Procedure and Conditions:</p> <p>This Certificate has been issued in accordance with FM Approvals US Certification Requirements.</p>
15.	<p>Schedule Drawings</p> <p>A copy of the technical documentation has been kept by FM Approvals.</p>
<u>THIS CERTIFICATE MAY ONLY BE REPRODUCED IN ITS ENTIRETY AND WITHOUT CHANGE</u>	
<p>FM Approvals LLC, 1151 Boston-Providence Turnpike, Norwood, MA 02062 USA T: +1 (1) 781 762 4300 F: +1 (1) 781 762 9375 E-mail: information@fmaprovals.com www.fmaprovals.com</p>	
F 347 (Mar 16)	Page 2 of 3

SCHEDULE

US Certificate Of Conformity No: FM17US0276



Member of the FM Global Group

16. Certificate History

Details of the supplements to this certificate are described below:

Date	Description
12 th August 1999	Original Issue.
6 th October 2017	<u>Supplement 7:</u> Report Reference: – RR210028 dated 6 th October 2017. Description of the Change: Company name change from Sartorius Mechatronics T&H GmbH. Certificate reformed.
10 th November 2017	<u>Supplement 8:</u> Report Reference: – RR211742 dated 10 th November 2017. Description of the Change: Addition of option a = 03.
24 th October 2018	<u>Supplement 9:</u> Report Reference: – RR215447 dated 24 th October 2018. Description of the Change: Update lower operating temperatures from -30°C to -40°C. Update FM Class 3600 from 2011 to 2018.
30 th July 2020	<u>Supplement 10:</u> Report Reference: – RR224030 dated 30 th July 2020. Description of the Change: Added load cell variation PR 6261.

THIS CERTIFICATE MAY ONLY BE REPRODUCED IN ITS ENTIRETY AND WITHOUT CHANGE

FM Approvals LLC, 1151 Boston-Providence Turnpike, Norwood, MA 02062 USA
T: +1 (1) 781 762 4300 F: +1 (1) 781 762 9375 E-mail: information@fmaprovals.com www.fmaprovals.com

F 347 (Mar 16)
Page 3 of 3

12.8 4012 101 5688

Weitergabe sowie Vervielfältigung dieses Dokuments, Verwertung und Mitteilung seines Inhaltes sind verboten, soweit nicht ausdrücklich gestattet. Zuwiderhandlungen verpflichten zu Schadensersatz. Alle Rechte für den Fall der Patent-, Gebrauchsmuster oder Geschmacksmusterertragung vorbehalten.

The copying, distribution and utilization of this document as well as the communication of its contents to others without expressed authorization is prohibited. Offenders will be held liable for the payment of damages. All rights reserved in the event of the grant of a patent, utility model or ornamental design registration.

Hazardous (Classified) Location
Class I, II, III, Division 1, Groups A,B,C,D,E,F,G

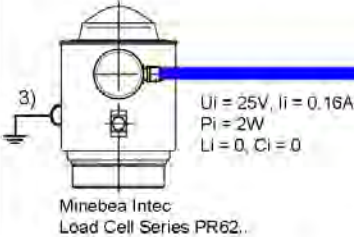

$U_i = 25V, I_i = 0.16A$
 $P_i = 2W$
 $L_i = 0, C_i = 0$

Minebea Intec
Load Cell Series PR62..

FM Approved Apparatus (USA) or product is suitably certified for use in Canada with Entity Concept parameters (see note 5) (V_o, I_o, C_o, L_o) appropriate for connection to intrinsically safe apparatus with Entity Concept parameters.

Hazardous (Classified) Location
Class I, II, III, Division 2, Groups A,B,C,D,E,F,G

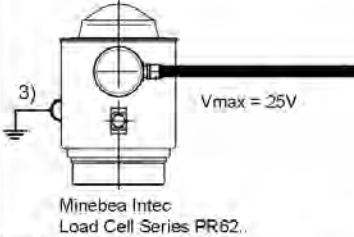

$V_{max} = 25V$

Minebea Intec
Load Cell Series PR62..

FM Approved Apparatus (USA) or product is suitably certified for use in Canada with nonincendive field wiring and output voltage of $25V_{max}$ to the load cells.

Notes

- 1) In the **USA**: The installation must be in accordance with the National Electrical Code[®], NFPA 70 and ANSI / ISA-RP 12.06.01.
 In **Canada**: The installation must be in accordance with the Canadian Electrical Code[®], Part 1.
- 2) The apparatus must not be connected to any device that uses or generates in excess of 250Vrms or DC.
 $U_{in} = 250V$.
- 3) In the **USA**: The Apparatus must be connected to a suitable ground electrode per National Electrical Code[®], NFPA 70, Article 504. The resistance of the ground pad must be less than 1 ohm.
 In **Canada**: The Apparatus must be connected to a suitable ground electrode per Canadian Electrical Code[®], Part 1. The resistance of the ground pad must be less than 1 ohm.
 The load cell ground (housing) must be insulated from the surface on which it is mounted or be at the same potential of the NRTL approved apparatus ground as per installation drawings.
- 4) **Connection must be made in accordance with the manufacturer's instructions** of the NRTL approved apparatus.
- 5) The Entity Concept allows interconnection of intrinsically safe apparatus with associated apparatus not specifically examined in combination as a system when the approved values of V_o and I_o of the associated apparatus are less than or equal to V_i and I_i of the intrinsically safe apparatus and the approved values of C_o and L_o of the associated apparatus are greater than C_i and L_i of the intrinsically safe apparatus plus all cable parameters.
- 7) Ambient temperature range:
 $-40^{\circ}C \dots +55^{\circ}C$ ($-40^{\circ}F \dots +131^{\circ}F$) for T5 and $-40^{\circ}C \dots +70^{\circ}C$ ($-40^{\circ}F \dots +158^{\circ}F$) for T4A.
- 8) **WARNING:** SUBSTITUTION OF COMPONENTS MAY IMPAIR INTRINSIC SAFETY
AVERTISSEMENT: LA SUBSTITUTION DE COMPOSANTS PEUT COMPROMETTRE LA SÉCURITÉ INTRINSÈQUE.

	Datum Date	Name	Material			Maßstab / Scale
Erstellt Written by	20.08.18	Schallhorn		Benennung / Title Load Cells Series PR62..		1:1
Geprüft Reviewed by	20.08.18	Hiller				
Freigabe Released by	20.08.18	Schallhorn	Ausgabe / Revision 04	Änderung / Alteration PA50180542	Zeichnungs-Nr. / Drawing number 4012 101 5688	Teildok. Nr. / Part doc. no 592

12.9 MEU17031



MEU17031

EU-Declaration of Conformity



1. Product model / product number / solely valid for project number:
 PanCake Level Sensor / PR 6251 / —
2. Name and address of the manufacturer (2.1) and his authorized representative (2.2):
 2.1 Minebea Intec GmbH, Meiendorfer Straße 205 A, 22145 Hamburg, Germany
 2.2 /
3. This declaration of conformity is issued under the sole responsibility of the manufacturer.
4. Object(s) of the declaration:
 4.1 PR 6251/___L
 4.2 PR 6251/___L (A.1)
 4.3 PR 6251/___L (A.2)
 4.4 PR 6251/___LE
 4.5 PR 6251/___LA
 4.6 PR 6251/___LAC
5. The object(s) of the declaration described above is in conformity with the relevant Union harmonization legislation:

	(4.1)	(4.2)	(4.3)	(4.4)	(4.5)	(4.6)
5.1 2014/30/EU	(6.1)	(6.1)	(6.1)	(6.1)	(6.1)	(6.1)
5.2 2011/65/EU	(6.2)	(6.2)	(6.2)	(6.2)	(6.2)	(6.2)
5.3 2014/34/EU		(6.3)	(6.4)	(6.5)		
6. References to the relevant harmonized standards used or references to the other technical specifications in relation to which conformity is declared:

6.1 2014/30/EU	EN 61326-1:2013, EN 61000-4-20:2010
6.2 2011/65/EU	EN 50581:2012
6.3 2014/34/EU	EN 60079-0:2012+A11:2013, EN 60079-15:2010, EN 60079-31:2014
6.4 2014/34/EU	EN 60079-0:2012+A11:2013, EN 60079-31:2014
6.5 2014/34/EU	EN 60079-0:2012+A11:2013, EN 60079-11:2012
7. The notified body w performed x and issued the certificate y relevant for z:

	w	x	y	z
7.1 /		Manufacturer's certificate	MIN16ATEX001X	(4.2)
7.2 0032		EC-Type Examination Certificate	TÜV 03 ATEX 2301 X	(4.3)
7.3 0158		EC-Type Examination Certificate	BVS 16 ATEX E 005	(4.4)
7.4 0102		Production Quality Assessment Notification	PTB 02 ATEX Q010	(4.3), (4.4)

Minebea Intec GmbH
 Hamburg, 29. May. 2017

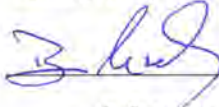

Dr. Bodo Krebs
President



Oliver Freitag
CE Certification

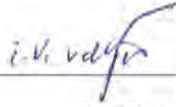

Kay v.d. Heydt
Ex Approval Manager

1/6



MEU17031

EU-Declaration of Conformity

Minebea
intec
The true measure

A. Additional information on ()::

A.1	(7.1)	Marking		II 3G Ex nA IIC T6 Gc II 3D Ex tc IIIC T85°C Dc MIN. 16 ATEX 001 X
A.2	(7.2)	Marking		II 1 D Ex t IIIC T ₅₀₀ 77 °C Da IP 65 TÜV 03 ATEX 2301 X
A.3	(7.3)	Marking		II 1G Ex ia IIC T6 Ga BVS 16 ATEX E 005
A.4	(6.4)	The above-mentioned product is in line with the requirements of the directive 2014/34/EU. One or more of the European Standards mentioned are already replaced by new editions. The manufacturer declares that the product also complies with these new editions, as the changed requirements of the new Standards do not affect the product.		



EU-Declaration of Conformity



MEU17031

Български (bg)
 Декларация за съответствие
 1. Модел на продукта / Номер на продукта / валякът също за номера на проекта:
 2. Наименование и адрес на производителя (2.1) и на неговия упълномощен представител (2.2)
 3. Настоящата декларация за съответствие е издадена на отговорността на производителя
 4. Предмет(и) на декларацията:
 5. Предметът (ите) на декларацията, описан(и) по-горе отговаря(т) на съответното законодателство на Съюза за хармонизиране:
 6. Посочване на приложимите хармонизирани стандарти или позоваване на други технически спецификации, по отношение на които се декларира съответствие.
 7. Упълномощеният орган в извършил и издаде сертификата у, отнасян се за:
 A. Допълнителна информация за ():
 A.1 Маркировка
 A.2 Маркировка
 A.3 Маркировка
 A.4 Горепосоченият продукт съответства на изискванията на Директива 2014/34/ЕС, Емисия или повече от приложимите европейски стандарти вече са заменени от нови издания. Производителят декларира, че продуктът съответства и на тези нови издания, тъй като промените изисквания на новите стандарти не засягат продукта.

Сетина (cs)
 Prohlášení o shodě
 1. Model výrobku / číslo výrobku / platné pouze pro číslo projektu:
 2. Jméno a adresa výrobce (2.1) a jeho zplnomocněného zástupce (2.2)
 3. Toto prohlášení o shodě se vydává na výhradní odpovědnost výrobce.
 4. Předmět(y) prohlášení:
 5. Výše popsaný předmět / Výše popsané předměty prohlášení je/ jsou ve shodě s příslušnými harmonizačními právními předpisy Unie
 6. Odůvodně na příslušné harmonizační normy, které byly použity, nebo na jiné technické specifikace, na jejichž základě se shoda prohlašuje.
 7. Označený subjekt v provedl s a vydal certifikát v relevantní z hlediska z:
 A. Další informace o ():
 A.1 Označení
 A.2 Označení
 A.3 Označení
 A.4 Výše uvedený výrobek je v souladu s požadavky směrnice Evropského parlamentu a Rady 2014/34/EU, jedná nebo více uvedených evropských norem již byly nahrazeny novými vydáními. Výrobce prohlašuje, že výrobek je v souladu s těmito novými vydáními, neboť upravené požadavky těchto nových norem nemají na výrobek vliv.

датски (da)
 Overensstemmelseserklæring
 1. Produktmodel / produktnummer / gælder kun for projektnummer:
 2. Fabrikantens (2.1) og dennes bemyndigede repræsentants (2.2) navn og adresse:
 3. Denne overensstemmelseserklæring udstedes på fabrikantens ansvar.
 4. Genstand(ene) for erklæringen:
 5. Genstand(ene) for erklæringen, som beskrevet ovenfor, er i overensstemmelse med den relevante EU-harmoniseringslovgivning.
 6. Referencer til de relevante anvendte harmoniserede standarder eller til de andre tekniske specifikationer, som der erklæres overensstemmelse med.
 7. Det bemyndigede organ har foretaget x og udstedt atesten y, der gælder for z:
 A. Supplerende oplysninger om ():
 A.1 Mærkning
 A.2 Mærkning
 A.3 Mærkning
 A.4 Ovenstående produkt opfylder kravene i direktiv 2014/34/EU. En eller flere af de anførte europæiske standarder er allerede blevet erstattet af nye udgaver. Fabrikanten erklærer, at produktet også er i overensstemmelse med de nye udgaver, idet de ændrede krav i de nye standarder ikke berører produktet.

Deutsch (de)
 Konformitätserklärung
 1. Produktmodell / Produktnummer / gilt ausschließlich für Projekt-Nr.:
 2. Name und Anschrift des Herstellers (2.1) und seines Bevollmächtigten (2.2)
 3. Die alleinige Verantwortung für die Ausstellung dieser Konformitätserklärung trägt der Hersteller.
 4. Gegenstände der Erklärung:
 5. Die oben beschriebenen Gegenstände der Erklärung erfüllen die einschlägigen Harmonisierungsrechtsvorschriften der Union
 6. Angabe der einschlägigen harmonisierten Normen oder der anderen technischen Spezifikationen, die der Konformitätserklärung zugrunde gelegt wurden:
 7. Die zuständige Stelle w hat x und die für z relevante Bescheinigung y ausgestellt.
 A. Zusatzangaben zu ():
 A.1 Kennzeichnung
 A.2 Kennzeichnung
 A.3 Kennzeichnung
 A.4 Das oben genannte Produkt erfüllt die Anforderungen der Richtlinie 2014/34/EU. Mindestens eine der aufgeführten europäischen Normen ist bereits durch eine neue Ausgabe ersetzt worden. Der Hersteller erklärt, dass das Produkt mit diesen neuen Ausgaben ebenfalls konform ist, da die geänderten Anforderungen der neuen Normen das Produkt nicht betreffen.

Ελληνικά (el)
 Δήλωση συμμόρφωσης
 1. Μοντέλο προϊόντος / αριθμός προϊόντος / ισχύει μόνο για τον αριθμό του έργου:
 2. Όνομα και διεύθυνση του κατασκευαστή (2.1) και του εξουσιοδοτημένου αναπαραστάτη του (2.2)
 3. Η παρούσα δήλωση συμμόρφωσης εκδίδεται με αποκλειστική ευθύνη του κατασκευαστή.
 4. Στόχος της δήλωσης:
 5. Ο στόχος της δήλωσης που περιγράφεται παραπάνω είναι σύμφωνα με τη σχετική ενωσιακή νομοθεσία ενωμοσύνης.
 6. Παραπομπές στα σχετικά ευρωπαϊκά πρότυπα που χρησιμοποιήθηκαν ή παραπομπές στις κοινές τεχνικές προδιαγραφές σε σχέση με τις οποίες δηλώνεται η συμμόρφωση.
 7. Ο κοστοποιήμενος οργανισμός w διεξήγαγε x και εξέδωσε το πιστοποιητικό y όπως απαιτείται για z:
 A. Προσθήκες πληροφοριών σχετικά με ():
 A.1 Σημείωση
 A.2 Σημείωση
 A.3 Σημείωση
 A.4 Το προαναφερθέν προϊόν συμμορφώνεται με τις απαιτήσεις της οδηγίας 2014/34/ΕΕ. Ένα ή περισσότερα από τα αναφερόμενα ευρωπαϊκά πρότυπα έχουν αντικατασταθεί ήδη από νέες εκδόσεις. Ο κατασκευαστής δηλώνει ότι το προϊόν συμμορφώνεται επίσης με τις εν λόγω νέες εκδόσεις, καθώς οι τροποποιημένες απαιτήσεις των νέων προτύπων δεν επηρεάζουν το προϊόν.

español (es)
 Declaración de conformidad
 1. Modelo de producto/número de producto / únicamente válido para el número de proyecto
 2. Nombre y dirección del fabricante (2.1) y de su representante autorizado (2.2)
 3. La presente declaración de conformidad se expide bajo la exclusiva responsabilidad del fabricante.
 4. Objeto(s) de la declaración:
 5. El/Los objeto(s) de la declaración descritos anteriormente son conformes con la legislación de armonización pertinente de la Unión Europea.
 6. Referencias a las normas armonizadas pertinentes utilizadas o referencias a las otras especificaciones técnicas respecto a las cuales se declara la conformidad.
 7. El organismo notificado W ha efectuado X y expedido el certificado Y relevante para Z.
 A. Información adicional en ():
 A.1 Marcado
 A.2 Marcado
 A.3 Marcado
 A.4 El producto mencionado anteriormente cumple con los requisitos de la directiva 2014/34/UE. Una o más de las normas europeas mencionadas ya se han substituído por nuevas ediciones. El fabricante declara que el producto también cumple con estas nuevas ediciones, ya que los requisitos modificados de las nuevas normas no afectan al producto.



EU-Declaration of Conformity

MEU17031

Minebea
intec
The Hue Measure

azeti keel (et)

Vastavusdeklaratsioon
1. Tootemudel / tootenumber / heliti) vaid järgmise projekti puhul:
2. Tootja nimi ja aadress (2.1) ning tema volitatud esindaja (2.2);
3. Käesolev vastavusdeklaratsioon on välja antud tootja autorisatsioonil;
4. Deklareeritav toode;
5. Olulised andmed deklareeritav toode on kooskõlas asjaomaste liidu ühildatavusaktidega;
6. Viited kasutatud harmoneeritud standarditele või viited muudele tehnilistele spetsifikatsioonidele, millele vastavus deklareeritakse;
7. Teavitatud asutus ja teostas, s) ja aadress) välja toetada z, mis on asjakohane y-le;
A. Lisateave järgmise kohta ():
A.1 Märgistus
A.2 Märgistus
A.3 Märgistus
A.4 Olulised andmed toode on kooskõlas direktiivi 2014/34/EÜ nõuetega. Üks või mitu nimetatud Euroopa standardit on asendatud juba uute väljannetega. Tootja kinnitab, et toode on kooskõlas ka nende uute väljannetega, kuna uute standardite muudetud nõuded ei mõjuta toodet.

français (fr)

Déclaration de conformité
1. Modèle / numéro de produit / valable uniquement pour le numéro de projet;
2. Nom et adresse du fabricant (2.1) et de son mandataire (2.2);
3. La présente déclaration de conformité est établie sous la seule responsabilité du fabricant;
4. Objet(s) de la déclaration;
5. Le ou les objets de la déclaration décrits ci-dessous est (sont) conforme(s) à la législation d'harmonisation de l'Union applicable;
6. Références des normes harmonisées pertinentes appliquées ou des autres spécifications techniques par rapport auxquelles la conformité est déclarée;
7. L'organisme notifié w a effectué x et a établi l'attestation y applicable à z;
A. Informations complémentaires relatives à ():
A.1 Marquage
A.2 Marquage
A.3 Marquage
A.4 Le produit mentionné est conforme aux exigences de la directive 2014/34/UE. Une ou plusieurs des normes européennes mentionnées ont déjà été remplacées par de nouvelles éditions. Le fabricant déclare que le produit est également conforme à ces nouvelles éditions, dans la mesure où les exigences modifiées des nouvelles normes n'affectent pas le produit.

hollandis (hr)

Izjava o skladnosti
1. Model proizvoda / broj proizvoda / važeći samo za broj projekta;
2. Naziv i adresa proizvođača (2.1) i njegovog ovlaštenog zastupnika (2.2);
3. Za izdavanje ove izjave o skladnosti odgovoran je isključivo proizvođač;
4. Predmet(i) izjave;
5. Predmet(i) navedene izjave po/su u skladu s mjerodavnim zakonodavstvom Unije o usklađivanju;
6. Pozivaju na relevantne primjenjene usklađene norme ili pozivaju na ostale tehničke specifikacije u vezi s kojima se izjavljuje skladnost;
7. Povoljeno tijelo w provelo je x i izdalo certifikat y koji je relevantan za z;
A. Dodatne informacije o proizvodu ():
A.1 Označavanje
A.2 Označavanje
A.3 Označavanje
A.4 Prethodno navedeni proizvod u skladu je sa zahtjevima Direktive 2014/34/EU. Jedna ili više navedenih europskih normi već je zamijenjeno novim izdanjima. Proizvođač izjavljuje da je proizvod u skladu i s tim novim izdanjima, jer se izmjenjeni zahtjevi ili novih normi ne odnose na proizvod.

magyar (hu)

Megfelelőségi nyilatkozat
1. Termékmódel / termékszám / kizárólag az alábbi projektszámhoz érvényes;
2. A gyártó (2.1) vagy adott esetben meghatalmazott képviselőjének (2.2) neve és címe;
3. Ezt a megfelelőségi nyilatkozatot a gyártó kizárólagos felelőssége mellett adja ki;
4. A nyilatkozat tárgya(i);
5. A fent ismertetett nyilatkozat tárgya megfelel a vonatkozó uniós harmonizációs jogszabványoknak;
6. Az alkalmazott harmonizált szabványokra való hivatkozás vagy az azokra az egyéb műszaki leírásokra való hivatkozás, amelyekkel kapcsolatban megfelelőségi nyilatkozatot tettek;
7. A(z) w bejelentett szervezet elvégezte a(z) x eljárást, és kiállította a(z) y kapcsolódó y tanúsítványt;
A. További információk ():
A.1 Jelölés
A.2 Jelölés
A.3 Jelölés
A.4 A fentebb megnevezett termék megfelel a 2014/34/EU irányelvben foglalt követelményeknek. Egy vagy több említett európai szabvány a kiállítás óta frissült. A gyártó kijelenti, hogy a termék megfelel a szabványok legújabb kiadásában foglalt követelményeknek, mivel a szabvány módosításai nem érintik az adott terméket.

italiano (it)

Dichiarazione di conformità
1. Modello di prodotto / numero di prodotto / valido unicamente per numero di progetto;
2. Nome e indirizzo del fabbricante (2.1) e del relativo rappresentante autorizzato (2.2);
3. La presente dichiarazione di conformità è rilasciata sotto la responsabilità esclusiva del fabbricante;
4. Oggetto della dichiarazione;
5. L'oggetto o gli oggetti della dichiarazione di cui sopra sono conformi alla pertinente normativa di armonizzazione dell'Unione;
6. Riferimento alle pertinenti norme armonizzate utilizzate o riferimenti alle altre specifiche tecniche in relazione alle quali è dichiarata la conformità;
7. L'organismo notificato w ha effettuato x e rilasciato il certificato y pertinente a z;
A. Informazioni aggiuntive su ():
A.1 Marcatura
A.2 Marcatura
A.3 Marcatura
A.4 Il prodotto menzionato in precedenza è conforme alle prescrizioni della direttiva 2014/34/UE. Una o più norme UE menzionate sono già state sostituite da nuove versioni. Il fabbricante dichiara che il prodotto è conforme anche alle nuove versioni in quanto le prescrizioni modificate delle nuove norme non interessano il prodotto.

latvian (lv)

Atbilstības deklarācija
1. Gatavības modeļis / gatavības numurs / galīgais (tik projekta numuram);
2. Gatavotāja (2.1) un viņa ietītoņa (2.2) pavadnības un adrese;
3. Šī atbilstības deklarācija izdotā tik gatavotāja atbildībā;
4. Deklarācijas objekts (objekti);
5. Pirmās apliecinātās deklarācijas objekts (objekti) atbilst saskaņotus derīguma termiņus Savienības tiesību aktos;
6. Saskaņotaj ūktyu darījumu standartu norodot arba kty ucilmināt specifikāciju, pgal kuras buvo deklarāta atbilstība, norodot;
7. Notifikotoji iestāga w atliko x ir izdāve sertifikāta y del z;
A. Papildoma informācija ():
A.1 Zīmkināmas
A.2 Zīmkināmas
A.3 Zīmkināmas
A.4 Pirmais norādītais gatavības atbilstība Direktīvas 2014/34/ES ietilpavims. Vienas ar keli mudojti Europos standartu jau pakēsti muijā redakcija. Gatavotājs patvārina, ka gatavības (atp) pat atbilsta naujajā redakcijā, nes pakēsti naujaj standartu ietilpavimi gatavimti povelkti neturi.



EU-Declaration of Conformity



MEU17031

latvian (lv)
 Atbilstības deklarācija
 1. Produkta modeļa / produkta numurs / derīgā tika projekta Nr.:
 2. Ražotāja (2.1.) un tā pilnvarotā pārstāvja (2.2.) nosaukums un adrese:
 3. Šī atbilstības deklarācija ir izdota vienīgi uz ražotāja atbildību
 4. Deklarācijas priekšmets vai priekšmeti:
 5. Iepriekš aprakstītā deklarācijas priekšmets vai priekšmeti atbilst attiecīgajam Savienības noteikuma aktam
 6. Atsauces uz attiecīgajiem izstrādājumiem saskaņotajiem standartiem vai uz citām tehniskajām specifikācijām, attiecībā uz ko tiek deklarēta atbilstība:
 7. Paziņotā struktūra w ir veikusi x un izsniegusi sertifikātu y, kas attiecas uz z:
 A. Papildu informācija par ():
 A.1 Marķējums
 A.2 Marķējums
 A.3 Marķējums
 A.4. Iepriekš minētās produkta atbilst Direktīvas 2014/34/ES prasībām. Viens vai vairāki no minētajiem Eiropas standartiem jauti ir atzīmēti ar jaunām versijām. Ražotājs apliecinā, ka produkts atbilst arī šīm jaunajām versijām, jo jāmāo saskaņotu minētās prasības noteiktām produktā.

italian (it)
 Dichiarazione di conformità
 1. Modello (tal-prodott / numru tal-prodott / valida bass għan-numri tal-prodott):
 2. L-ismen u l-indirizz tal-manifattur (2.1) u l-ar-rappreżentanti awtorizzati tiegħa (2.2):
 3. Din id-dikjarazzjoni ta' konformità tindareg tal-ir-responsabbiltà unika tal-manifattur
 4. L-għan(jiet) tad-dikjarazzjoni:
 5. L-għan(jiet) tad-dikjarazzjoni deskritt(i) huw(n) fuq luwa(h)uwa) konformi mal-legislazzjoni ta' armonizzazzjoni rilevanti tal-Unjoni:
 6. Ir-referenzi għall-istandards armonizzati rilevanti li nużaw, jew ir-referenzi għall-specifikazzjonijiet teknici l-oħra li s-konform qad tigi ddikjarata l-konformità:
 7. Il-korp notifikat w wettaq x u hareg id-certifikat u rilevanti għal z:
 A. Informazzjoni addizzjonali fuq ():
 A.1 Immarkar
 A.2 Immarkar
 A.3 Immarkar
 A.4 Il-prodott msemmi luwa fuq luwa l-konformità mar-rekwiżiti tad-Direttiva 2014/34/UE. Wieheh jew aktar null-standards Ewropej imsemmija digi jew sostitwiti l-edizzjonijiet godda bass. Il-manifattur jidkljarah li l-prodott luwa konformi wkoll ma' dawn l-edizzjonijiet godda, għax ir-rekwiżiti tal-standards il-godda ma jaffettwaw il-prodott

dutch (nl)
 Conformiteitsverklaring
 1. Productmodel / productnummer / uitstaand geldig voor projectnummer:
 2. Naam en adres van de fabrikant (2.1) en zijn gemachtigde (2.2):
 3. Deze conformiteitsverklaring wordt verstrekt onder volledige verantwoordelijkheid van de fabrikant.
 4. Voorwerpen van de verklaring:
 5. Het (de) hierboven beschreven voorwerpen (is (zijn)) in overeenstemming met de desbetreffende harmonisatiewetgeving van de Unie.
 6. Vermelding van de toegepaste relevante geharmoniseerde normen of van de overige technische specificaties waarop de conformiteitsverklaring betrekking heeft.
 7. De aangemelde instantie w heeft een x uitgevoerd en het certificaat w verstrekt dat relevant is voor z:
 A. Aanvullende informatie over ():
 A.1 Markering
 A.2 Markering
 A.3 Markering
 A.4 Het bovengenoemde product voldoet aan de eisen van Richtlijn 2014/34/EU. Een of meer van de genoemde Europese normen zijn inmiddels vervangen door nieuwe versies. De fabrikant verklaart dat het product ook aan deze nieuwe versies voldoet, aangezien de gewijzigde eisen van de nieuwe normen geen gevolgen hebben voor het product.

polish (pl)
 Deklaracja zgodności
 1. Model produktu / numer produktu / ważny wyłącznie dla projektu o numerze:
 2. Nazwa i adres producenta (2.1) oraz jego upoważnionego przedstawiciela (2.2).
 3. Niniejsza deklaracja zgodności wydana zostaje na wyłączną odpowiedzialność producenta.
 4. Przedmiot(-y) deklaracji:
 5. Wymieniony powyżej przedmiot (lub przedmioty) niniejszej deklaracji jest zgodny z odnośnymi wymaganiami unijnego prawodawstwa harmonizacyjnego:
 6. Odwołania do odnośnych norm zharmonizowanych, które zastosowano, lub do innych specyfikacji technicznych w stosunku do których deklarowana jest zgodność:
 7. Jednostka notyfikowana w przeprowadziła x i wydała certyfikat y odpowiedni dla z:
 A. Informacje dodatkowe o ():
 A.1 Czynkowanie
 A.2 Czynkowanie
 A.3 Czynkowanie
 A.4 Wyżej wymieniony produkt jest zgodny z wymaganiami Dyrektywy 2014/34/UE.
 Co najmniej jedna wymieniona norma europejska została już zastąpiona nowymi wydaniami. Producent oświadcza, że produkt spełnia wymagania także takich nowych wydań norm, gdyż zmienione wymagania zawarte w nowych normach nie mają wpływu na produkt.

portuguese (pt)
 Declaração de conformidade
 1. Modelo do produto / número do produto / somente válido para o número de projeto:
 2. Nome e endereço do fabricante (2.1) e do seu mandatário (2.2).
 3. A presente declaração de conformidade é emitida sob a exclusiva responsabilidade do fabricante.
 4. Objeto(s) da declaração:
 5. O(s) objeto(s) da declaração acima descrito(s) estão(ão) em conformidade com a legislação aplicável de harmonização da União:
 6. Referências às normas harmonizadas aplicáveis utilizadas ou às outras especificações técnicas em relação às quais é declarada a conformidade:
 7. O organismo notificado w realizou x e emitiu o certificado y relevante para z:
 A. Informações complementares relativa a ():
 A.1 Marcação
 A.2 Marcação
 A.3 Marcação
 A.4 O produto acima mencionado está em consonância com os requisitos da diretiva 2014/34/UE. Uma ou mais das Normas Europeias mencionadas acima já foram substituídas por novas edições. O fabricante declara que o produto também está em conformidade com essas novas edições, uma vez que os requisitos alterados dessas novas Normas não afetam o produto.

romanian (ro)
 Declarație de conformitate
 1. Modelul de produs / Număr produs / validă numai pentru numărul proiectului:
 2. Denumirea și adresa producătorului (2.1) și a reprezentantului său autorizat (2.2).
 3. Prezenta declarație de conformitate este emisă pe răspunderea exclusivă a producătorului.
 4. Obiectul (obiectele) declarației:
 5. Obiectul (obiectele) declarației descrise mai sus sunt în conformitate cu legislația relevantă de armonizare a Uniunii:
 6. Trimiten la standardele armonizate relevante folosite sau trimiten la celelalte specificații tehnice în legătură cu care se declară conformitatea:
 7. Organismul notificat w a efectuat x și a emis certificatul y corespunzător pentru z:
 A. Informații suplimentare despre ():
 A.1 Marcă
 A.2 Marcă
 A.3 Marcă
 A.4 Produsul menționat anterior respectă cerințele directivei 2014/34/UE. Unul sau mai multe din standardele europene menționate sunt deja înlocuite de noi ediții. Producătorul declară faptul că produsul respectă de asemenea aceste noi ediții, ășadar cerințele modificate ale noilor standarde nu afectează produsul.



EU-Declaration of Conformity

MEU17031

Minebea
intec
The Hue Measure

slovenščina (sl)

Vyhlašenje o zhlode
1. Model výroba / číslo výroba / platné lan pre číslo projekta.
2. Meno/názov a adresa výroba (2.1) a jeho spoločného zástupcu (2.2).
3. Toto vyhlášení o zhlode sa vydáva na vlastnú zodpovednosť výroba.
4. Predmet(-y) vyhlášení.
5. Uvedený predmet či uvedené predmety vyhlášení sú v zhode s príslušnými harmonizačnými právnymi predpismi Únie.
6. Odhady na príslušné použité harmonizačné normy alebo odkazy na tie technické špecifikácie, v súvislosti s ktorými sa zhlode vyhlášení.
7. Notifikovaný orgán w vykonal x a vydal certifikát y relevantný pre z:
A.1 Označenie
A.2 Označenie
A.3 Označenie
A.4 Vyššie uvedení výroba je v súlade s požiadavkami smernice 2014/34/EU. Jedna alebo viaceré z uvedených európskych noriem sú už nahradené novými vydávanými. Výroba vyhlášení. Je výroba je v zhode aj s týmito novými vydávanými, pretože zmena požiadavky nových noriem nemá na výroba vplyv.

slovenščina (sl)

Izjava o skladnosti
1. Model proizvoda / serijska številka proizvoda / veljavno samo za številko projekta.
2. Ime in naslov proizvajalca (2.1) ter njegovega pooblaščenega zastopnika (2.2).
3. Za izdajo te izjave v skladnosti je odgovoren izključno proizvajalec.
4. Predmet(i) izjave:
5. Predmet(i) navedene izjave je (so) v skladu z ustrezno zakonodajo Unije o harmonizaciji.
6. Sklepevanja na uporabljene ustrezne harmonizirane standarde ali sklepevanja na druge tehnične specifikacije v zvezi s skladnostjo, ki je navedena v izjavi.
7. Priglaseni organ w je izvedel x in izdal certifikat y, pomemben za z:
A.1 Označba
A.2 Označba
A.3 Označba
A.4 Zgornji navedeni proizvod je v skladu z zahtevami direktive 2014/34/EU. Enega ali več omenjenih evropskih standardov so že nadomestile nove izdaje. Proizvajalec izjavlja, da je proizvod skladen s temi novimi izdajami, saj spremenjena zahteva novih standardov ne vplivajo na proizvod.

slovenščina (sl)

Vaatimustenmukaisuusvakuutus
1. Tuotteen / tuotenumero / koskee vain projektinumero.
2. Valmistajan (2.1) ja valtuutetun edustajan (2.2) nimi ja osoite.
3. Tämä vaatimustenmukaisuusvakuutus on annettu valmistajan yksinomaista vastuulla.
4. Vakuutuksen kohde (kohdet):
5. Edellä kuvattu (kuvatut) vakuutuksen kohde (kohdet) on (ovat) asiaa koskevan unionin yhdenmukaistamissääntöjen vaatimusten mukainen (mukaisia).
6. Viittaus niihin asiaa koskeviin yhdenmukaistettuihin standardeihin, joita on käytetty, tai viittaus muihin teknisiin eritelmiin, joiden perusteella vaatimustenmukaisuusvakuutus on annettu.
7. Ilmoitettu laitos w suoritti x ja antoi todistuksen y liittyen z:
A.1 Lisätietoja ():
A.1 Merkintä
A.2 Merkintä
A.3 Merkintä
A.4 Yllä mainittu tuote vastaa direktiivin 2014/34/EU vaatimuksia. Yksi tai useampi mainittuista eurooppalaisista standardeista on jo korvattu uusilla painoksilla. Valmistaja vakuuttaa, että tuote vastaa myös niitä uusia painoksia, koska uusien standardien muutokset määrityksiä eivät vaikuta tuoteseen.

svenska (sv)

Försäkran om överensstämmelse
1. Produktmodell / produktnummer / gäller endast för projektnummer.
2. Tillverkarens namn och adress (2.1) och dess auktoriserade representant (2.2).
3. Denna försäkran om överensstämmelse utdödas på tillverkarens eget ansvar.
4. Föremål för försäkran.
5. Föremålet/föremålen för försäkran öyut överensstämmer med den relevanta harmoniserade unionslagstiftningen.
6. Hänvisningar till de relevanta harmoniserade standarder som antas eller hänvisningar till de andra tekniska specifikationer enligt vilka överensstämmelsen försäkras.
7. Det nämnda organet w har utfört x och utfärdat intyget y relevant för z:
A. Ytterligare information om ():
A.1 Märkning
A.2 Märkning
A.3 Märkning
A.4 Övan nämnda produkt är i linje med kraven i direktiv 2014/34/EU. En eller flera av de nämnda europeiska standarderna har redan ersatts av nya upplagor. Tillverkaren försäkrar att produktén även överensstämmer med dessa nya upplagor, då de antralde kraven i de nya standarderna inte påverkar produktén.

12.10 RU Д-DE.A301.B.05345

	ЕВРАЗИЙСКИЙ ЭКОНОМИЧЕСКИЙ СОЮЗ ДЕКЛАРАЦИЯ О СООТВЕТСТВИИ
<p>Заявитель Общество с ограниченной ответственностью «ДС Компания». Основной государственный регистрационный номер: 1107746937374. Место нахождения: 105037, Российская Федерация, город Москва, улица 3-я Парковая, дом 9, квартира 18 Телефон: 89660273663, адрес электронной почты: dc.company2000@gmail.com в лице Генерального директора Ежова Олега Олеговича</p>	
<p>заявляет, что Товары/услуги типов: PR6201, PR6202, PR6211, PR6212, PR6251, PR6221, PR6261, PR6224, PR6204, PR6246, PR6241, PR6207 Продукция изготовлена в соответствии с Директивой 2014/30/ЕС «Электромагнитная совместимость» изготовитель Minebea Intec GmbH. Место нахождения: ГЕРМАНИЯ, Meiendorfer Strasse 205, 22145 Hamburg</p>	
<p>код ТН ВЭД ЕАЭС 9031 80 380 0</p>	
<p>Серийный выпуск соответствует требованиям Технического регламента Таможенного союза ТР ТС 020/2011 "Электромагнитная совместимость технических средств"</p>	
<p>Декларация о соответствии принята на основании протокола испытаний № 314-04/12-СТ от 13.04.2017 года, выданного испытательной лабораторией «Серт-Тест» Общества с ограниченной ответственностью «Серт и Ко», регистрационный № РОСС RU.04ИДЮ0.002: руководства по эксплуатации; паспорта</p>	
<p>Схема декларирования: Id</p>	
<p>Дополнительная информация Условия хранения продукции в соответствии с требованиями ГОСТ 15150-69. Срок хранения (службы, годности) указан в прилагаемой к продукции эксплуатационной документации. Стандарты, обеспечивающие соблюдение требований Технического регламента Таможенного союза ТР ТС 020/2011 "Электромагнитная совместимость технических средств": ГОСТ 30804.3.2-2013 "Совместимость технических средств электромагнитная. Эмиссия гармонических составляющих тока техническими средствами с потребляемым током не более 16 А (в одной фазе). Нормы и методы испытаний", ГОСТ 30804.3.3-2013 "Совместимость технических средств электромагнитная. Ограничение изменений напряжения, колебаний напряжения и фликера в низковольтных системах электроснабжения общего назначения. Технические средства с потребляемым током не более 16 А (в одной фазе), подключаемые к электрической сети при несоблюдении определенных условий подключения. Нормы и методы испытаний"</p>	
<p>Декларация о соответствии действительна с даты регистрации по 12.04.2022 включительно.</p>	
	<p>Ежов Олег Олегович <small>(подпись и печать уполномоченного представителя лиц, зарегистрированных в качестве индивидуального предпринимателя)</small></p>
<p>Сведения о регистрации декларации о соответствии: Регистрационный номер декларации о соответствии: ЕАЭС № RU Д-DE.A301.B.05345 Дата регистрации декларации о соответствии 13.04.2017</p>	

Published by
Minebea Intec GmbH | Meiendorfer Strasse 205 A | 22145 Hamburg, Germany
Phone: +49.40.67960.303 | Email: info@minebea-intec.com
www.minebea-intec.com

