

# High performance steel processing systems

---

First class,  
sustainable steel  
products



**KALTENBACH**

POWERFUL SOLUTIONS - PASSIONATE PEOPLE

 [www.kaltenbach.com](http://www.kaltenbach.com)



## ■ POWERFUL SOLUTIONS - PASSIONATE PEOPLE

Sawing, drilling, thermal cutting, shot blasting or painting - working with steel means creating for the future. With more than 135 years of experience, KALTENBACH is one of the leading companies in high-quality steel processing and conservation equipment, worldwide.

Creative and innovative solutions to guarantee the quality of your steel products. Durable and robust. Most environmentally friendly machines, with considerable savings on energy and consumables and best costs of ownership. Special attention is given to a safe, healthy and pleasant working environment.

Our passionate teams have worked for years to create and optimize products that give you a competitive advantage in your business.



## High performance steel processing systems. First class, sustainable steel products

Steel processing stands for the fabrication of new long lasting structures. While producing such durable materials and products, you will need the most powerful and reliable machines. From small fabrication shops to steel construction, from bridge building to automotive industry. Our enthusiastic team of professionals knows your business and the challenges you have to face every day. Many years of experience and high innovation rates enable us to set the standard in the industry, especially in the areas of sustainability and cost effective processing. As a trend setter and technology leader, we are able to supply premium quality solutions, combined with an attractive and functional machine design.

Our product ranges bring total solutions and special machines for sawing, drilling, plate processing, as well as coping robots. In order to drive your efficiency, we provide solutions with smart logistics, including reliable transport systems and the latest software technology to boost your automation level. Powerful, highly versatile systems, whereby quick return on investment is made possible by means of a high level of performance and productivity.

Our software, machinery and skilled service and spare parts department enable to install and run your machine with the highest uptime and lowest cost of ownership.

### ■ Cutting-edge sawing, drilling and plate processing technology



#### EXCEPTIONAL RELIABILITY AND MAXIMUM UPTIME

Our systems are characterized by an outstanding and industry-leading durability. The robust and reliable design enables extraordinary operating times, even with the most intensive loads.



#### MOST ENVIRONMENTALLY FRIENDLY SOLUTIONS

Our systems are designed to be robust, energy friendly and require little maintenance. This ensures a long service life, with minimal wear and tear. Your products will be produced with most durable constructions, including significant energy saving possibilities.



#### LOWEST COST OF OWNERSHIP

Thanks to our efficient machines, your products will be produced with the lowest possible energy consumption, a minimum usage of consumables and reduced maintenance costs. High-quality steel products made at the lowest cost of ownership.

# Integrated high-quality solutions for the steel industry

## OVER 135 YEARS OF ACCUMULATED KNOW-HOW

With complete high-performance lines and special machinery, we know how to boost your efficiency and productivity. You will be assured of the right solution for any requirement. Effective, reliable and safe.

### Circular and Band Sawing

In order to produce high-quality products, speed, quality and precision are crucial factors. From simple straight or mitre cuts to multiple overlapping saw cuts at different angles. Circular or band, KALTENBACH will have the perfect saw for your business.

### Drilling

Improved drilling performance. Efficient and accurate milling of notches, chamfers, slots and pockets. Thanks to powerful drives, high torques and fast rotational speeds, you will get the best model for your needs.

### Coping

Unique coping robots with enormous possibilities give you the freedom to cut complex parts automatically, with a high accuracy and minimum rework. Consistent high quality, even with complex cutting processes. Modern software components enable simulations, feasibility tests and collision control.

### Plate Processing

Multiple technologies in one machine enable to produce your plates in the most efficient way. The high automation level of our KALTENBACH machines will boost your productivity and profitability. Highly effective technologies for cutting plates. Guaranteed speed, efficiency and profitability.

■ We know how to boost your efficiency and productivity

### Transporting and Measuring

Efficient material handling and precise measurement not only ensure the quality of your products, they also increase your productivity. Thanks to our modular design, individual solutions can be easily combined to realize a successful plant integration within your production environment.

Help and advice from our staff in Sales, Technical Services and Support are an integral part of KALTENBACH systems. Whatever your question and wherever you are in the world – we are there for you.

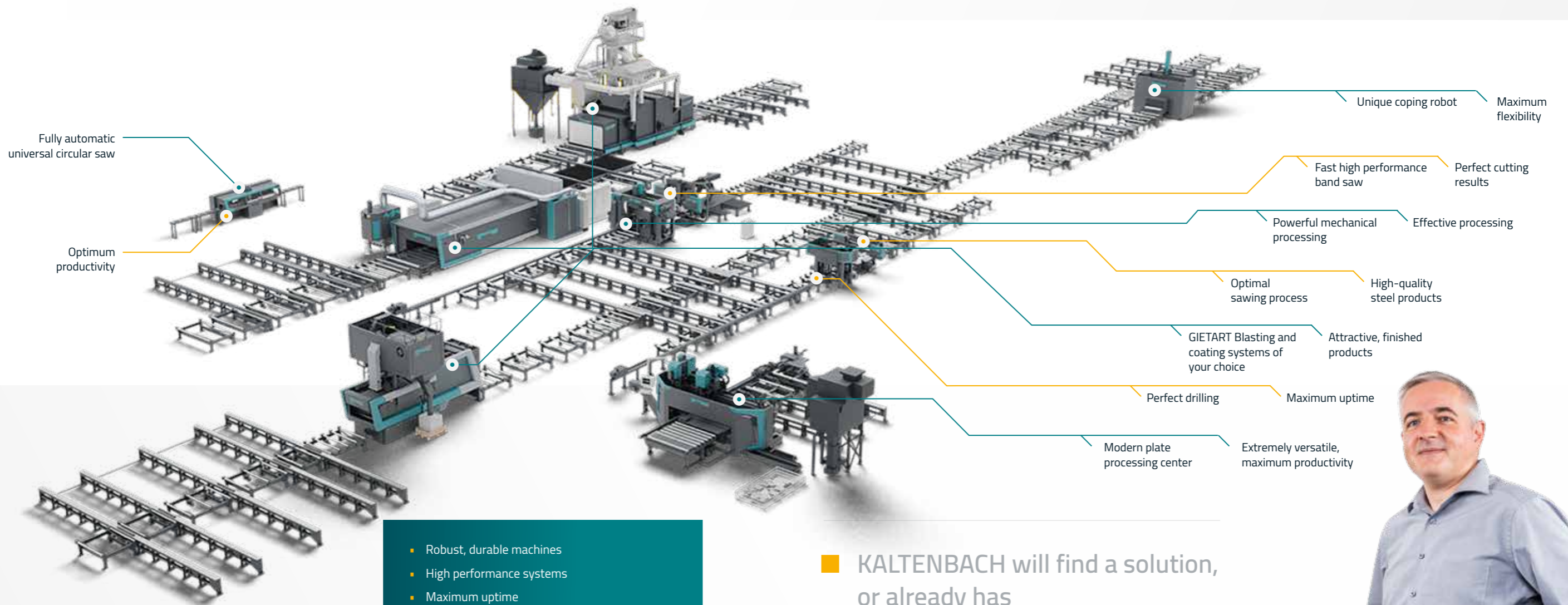

- Robust, durable machines
- High performance systems
- Maximum uptime
- Lowest cost of ownership
- Intelligent automation possibilities

■ KALTENBACH will find a solution, or already has



- Fast and reliable sawing

**INCREASED PRODUCTIVITY,  
NOTICEABLY REDUCED COSTS**



- Rapid and powerful sawing
- High level of production flexibility
- Economical design
- High cutting performance
- Precise setting of cutting angle
- Low saw band wear

An highly innovative steel profile band saw which delivers outstanding cutting performance. With this mitring saw you will be assured of the best possible saw for your business. Fast, precise and comfortable sawing of steel profiles ensures a high level of production flexibility, up to +/- 60°.

Capacity range 90°, 600 x 410 or 1,000 x 410 mm  
Band saw with mitre unit for light steel fabrication and service centers

**BENEFITS AT A GLANCE**

- High level of production flexibility up to +/- 60°
- Precise setting of cutting angle with NC-controlled drive
- Rapid working feed concept for shorter idle times, thanks to ball screw spindle
- Cut monitoring system incl. cutting pressure and slippage control for perfect quality
- Small footprint and low energy consumption
- Laser-assisted cutting edge visualization for manual cuts

H T L U - O □



- Precision plus power equals quality

**HIGHLY VERSATILE BAND SAW FOR  
EXCELLENT STEEL PRODUCTS**



- Best cutting results
- Robust construction
- Rapid and powerful sawing
- Perfect cutting performance
- High level of production flexibility
- Precise setting of cutting angle

Achieve the utmost flexibility in your factory with KALTENBACH's high level band saws for processing steel profiles. Powerful, automated and comfortable sawing of single beams, bundles or layers. Whatever your requirements, our team of experts can advise you on implementing the best solution.

Capacity range 90°, from 400 x 350 to 1,010 x 500 mm  
Band saws with mitre unit (+60°/-45°) for light and medium steel fabrication and service centers

**BENEFITS AT A GLANCE**

- Long saw band life and the best cutting quality
- Robust, low-vibration design for perfect cutting results
- Very solid and reliable clamping system
- Laser-assisted cutting edge visualization for manual cuts
- Cut monitoring system incl. cutting pressure and slippage control for perfect quality

H T L U - O □



Speed,  
quality,  
precision

**CONSISTENT HIGH PROCESSING STANDARDS**



- High-performance technology
- First class steel products
- Powerful clamping system
- Sturdy construction
- Enhanced automation opportunities
- High level of flexibility

Industry 4.0 Ready

Specially developed band saws for perfect steel processing. Constructed on the basis of high cutting performance, full automation and low maintenance requirements. We are happy to apply our knowledge and expertise for customers looking to distinguish themselves in the market!

Capacity range 90°, from 750 x 500 to 1,350 x 500 mm  
Band saws with mitre unit (-45°/90°/+60°/-50°/+30°) for light- to heavy-duty steel fabrication and service centers

**BENEFITS AT A GLANCE**

- Robust, low-vibration design for perfect cutting results
- Automatic control of saw band angle by Auto-Feed-Control
- Powerful drive motor
- Long blade life, optimum cutting quality
- Highest automation opportunities for short piece handling
- Rapidly working feed concept for shorter idle times due to ball screw spindles

H T L U - O □

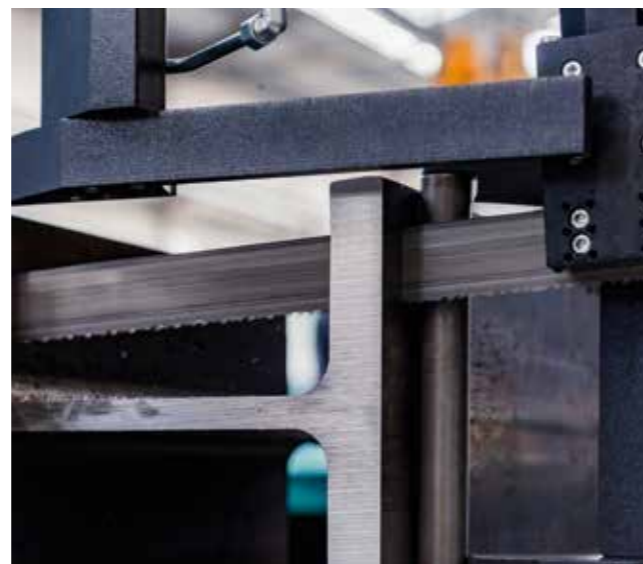

An excellent  
machine for  
maximum  
productivity

**HIGH-PERFORMANCE,  
PERFECT CUTTING RESULTS**



- Unrivalled quality
- Very short cutting times
- Precise positioning
- Perfect angle setting
- High process reliability
- Long service life

Refit solution

The HDM 1432 is a high-performance, heavy section sawing system, specifically designed for heavy-duty steel fabrication and steel service centers. The machine is suitable for sawing individual parts, layers and bundles. It works with perfect cutting results and shorter cutting times. Large steel profiles can be sawn in a record breaking speed. Contact us for all interesting details!

Capacity range 90°, 1,200 x 450 mm  
Semi-automatic circular sawing machine with one segmental saw blade Ø 1,430 mm, for sawing structural profiles with mitre cut device

**BENEFITS AT A GLANCE**

- Vertical saw on robust pivot bearing
- Powerful drive for high-performance cutting
- Single cuts in addition to layer and bundle cuts possible
- NC-controlled cutting-angle setting
- A drill can be incorporated to create a saw-drill combination
- Perfect cutting results and long blade life

H T L U - O □



- Powerful drilling, every single time

**A PERFECT AND TOTALLY RELIABLE PACKAGE**



- High-performance drilling
- Wide range of machining capabilities
- State-of-the-art technology
- Robust low-vibration design
- Rapidly working feed concept for higher uptime
- Direct drive motor spindles

Fast, automated and accurate steel processing. Powerful systems for all modern processing technologies, such as milling, drilling, tapping, counter-sinking and marking. With a robust low-vibration design to extend the life of machinery and tools. Choose KALTENBACH drilling systems and achieve excellent quality! Our compact and economically built machines provide increased flexibility to meet your needs regarding steel processing.

Capacity range 410 x 600 or 410 x 1,000 mm  
Drilling machines with tool changer for 5 tools per axis for light- and medium-duty steel fabrication and service centers

**BENEFITS AT A GLANCE**

- > Efficient drilling, milling, marking, tapping and counter-sinking
- > Compact design for perfect processing performance
- > Long service life
- > Tool changer for 5 tools per axis for less set-up times
- > Intelligent software solutions for optimum machining results
- > A saw can be incorporated to create a saw-drill combination



H T L U - □

- Dynamic processing of complex tasks

**MEETING THE HIGHEST DEMANDS IN DRILLING STEEL**

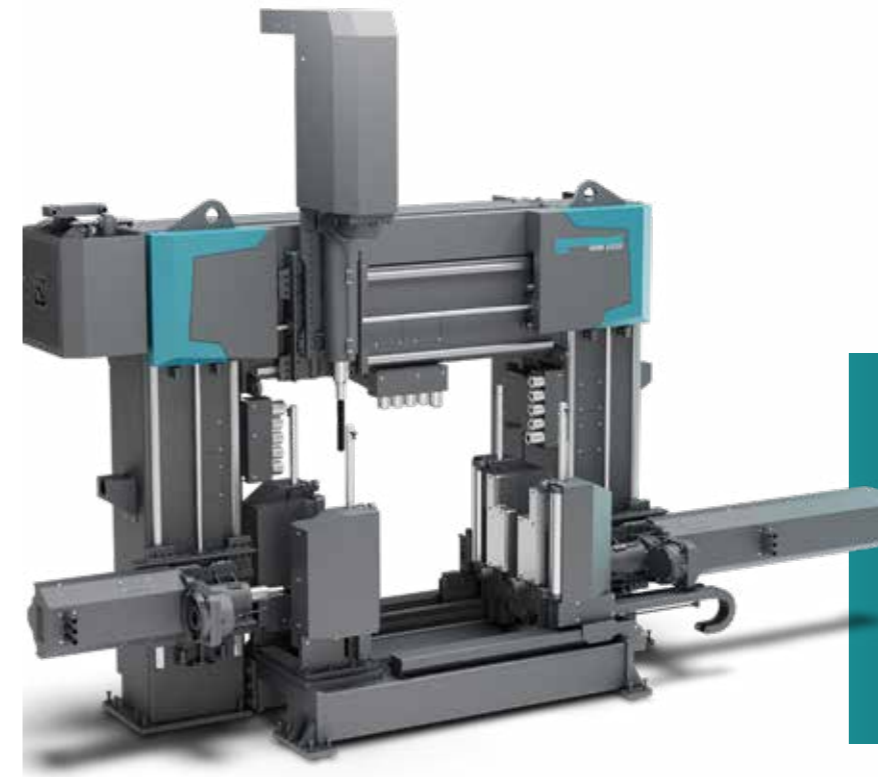

- High-performance drilling
- Wide range of machining capabilities
- Automatic tool change system
- Rapidly working feed concept for shorter idle times
- Powerful clamping system, prolonged tool life
- Lowest cost of ownership

Our valuable expertise in the field of drilling enables us to produce highly effective machines. Most environmentally friendly solutions with maximum uptime. You will be assured of the most modern, powerful, automated steel processing systems. Easy to operate drills, provided with all modern processing technologies like milling, carbide drilling, tapping, counter-sinking and marking.

Capacity range 90°, 500 x 600 or 500 x 1,000 mm  
Drilling machines with tool changer for 5 tools per axis for light, medium and heavy steel fabrication and service centers

**BENEFITS AT A GLANCE**

- > Robust low-vibration design
- > Tool changer for 5 tools per axis for less set-up times
- > Highly efficient drilling, milling, marking, tapping and counter-sinking
- > Intelligent material measurement, high process reliability
- > Powerful drive for maximum processing performance
- > High-precision axis positioning and feed control



H T L U - □

- Highly productive, parallel and versatile machining

**UNIQUE 3 AXIS DRILLING AND MACHINING**



► **Industry 4.0 Ready**

- High-quality steel products
- 500 mm sub-axis for increased flexibility and fast processing
- High range of milling possibilities
- Large automatic tool change system
- Smart software solutions
- Integrated, intelligent material measurement

High-performance steel processing systems, perfectly suited for a wide range of machining capabilities, with parallel processes. Unique drilling machines with advanced machining techniques such as milling, carbide drilling, tapping, counter-sinking and marking. You will be able to realize a remarkable quality and outstanding productivity on every job.

Capacity range from 750 x 600 to 1,300 x 600 mm  
Drilling machine with tool changer for 12 tools per axis for medium and heavy steel fabrication and service centers

**BENEFITS AT A GLANCE**

- Highly efficient drilling, milling, marking, tapping and counter-sinking
- Easy to operate, low maintenance system
- Robust clamping system and spindle design
- Automatic material measurement and tolerance correction
- Additional sub-axis for parallel processing of each axis
- Optimum machining results



H T L U - O □

- You will be able to meet your production needs with total precision

**ULTRA-PRECISE POSITIONING, CONSISTENT HIGH QUALITY**



- Free shape 3D cutting
- Ultimate versatile coping system
- Intelligent software for minimum rework of cuts
- Fully enclosed
- High, operational safety
- Optimum process quality

Enhance your manufacturing level with the intelligent coping robots of KALTENBACH. Sophisticated systems for applying a wide variety of chamfers, internal contours, longitudinal cuts, slots, holes, mitre and straight cuts. Innovative, mechanized systems for both plasma and oxyfuel cutting. Secure your capital with machinery of excellence!

Working range (w x h), 1,220 x 475 mm  
Marks and cuts structural steel on 4 sides  
Profile processing robot with advanced motion control

**BENEFITS AT A GLANCE**

- Automatic generation of robot programs
- Machining simulation and collision control for trouble-free operation
- User-friendly operation and programming
- Consistently high quality, even with complex cutting processes



H T L U - O □

**DURABLE DESIGN,  
 VERSATILE PROCESSING**



- Fully automatic handling
- Highly convenient system operation
- Clean working environment
- Fast set-up times
- Easy maintenance
- Maximum uptime

Achieve the highest productivity and efficiency with our oxy-fuel cutting, plasma cutting and plate drilling systems. Various operations such as drilling, milling, tapping, counter-sinking, pop-marking, contour-marking, hard stamping and thermal cutting can be carried on one single machine. Contact one of our experts to upgrade your production process.

Capacity range (w x l), from 2,100 to 3,100 x 6000 mm (optional 12,000 mm)  
 Advanced plate processing and drilling center for plates

**BENEFITS AT A GLANCE**

- ▶ Up to 2 drilling heads and plasma heads for maximum output
- ▶ Powerful motor drives for perfect drilling and milling
- ▶ Highly efficient, cost-effective production
- ▶ Wastage limited to a minimum
- ▶ Maximum performance
- ▶ Optimal cutting quality



Maximum performance and optimal cutting quality

**Transport systems**

**ROLLER CONVEYORS**

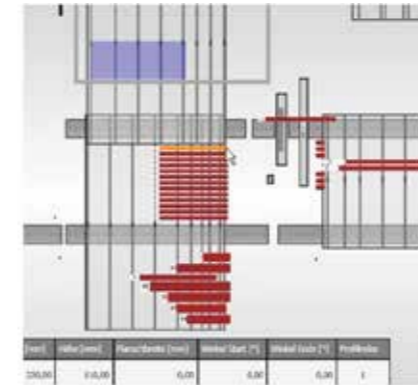

Material visualisation and tracking

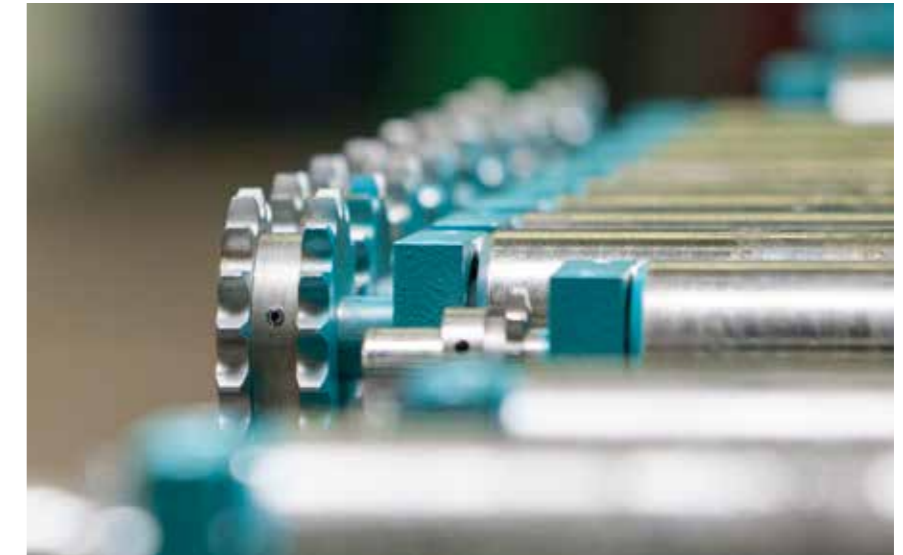

Robust construction capable of handling up to 1,000 kg/m

**CROSS-CONVEYORS**



Cross-conveyor with drag chains for robust and low-maintenance transport.



Cross-conveyor with lifting pins for conveyance in two directions.



Cross-conveyor with lifting carriage especially for profile bundles, layers and plates.

**SHORT PIECE REMOVAL SYSTEMS**



Pusher for easy removal of short good parts and even heavy parts.



Short piece gripper for the rational removal of short parts.



Automatic removal of good parts on/to up to six sorting positions.



- Unique modular systems, easy adjustable to your specific requirements

**PUSHERS, GRIPPERS AND MEASURING SYSTEMS**



- Optimal process flow
- Intelligent control solutions
- Fast material transport
- Efficient batch processing
- Fully automated processes
- Lowest cost of ownership

Logistics around the machine are one of the most important processes to increase the capacity of the line. Our measuring and transport systems are specially designed to ensure an optimal process flow, and therefore the most effective processing of material in your production area. Contact us and we can help you to increase your productivity.

Measuring carriages with various types of pushers and grippers  
Custom made conveyor systems for profile bundles, layers and plates



**BENEFITS AT A GLANCE**

- ▶ Accurate positioning of material
- ▶ Excellent material visualization and tracking
- ▶ Flexible measurement systems
- ▶ Flexible connection interfaces to various ERP/MRP systems
- ▶ Possibilities to handle a wide range of products

H T L U - O □

- Increased productivity, noticeably reduced costs

**KALTENBACH SAW DRILL COMBINATION KBB/KDB**

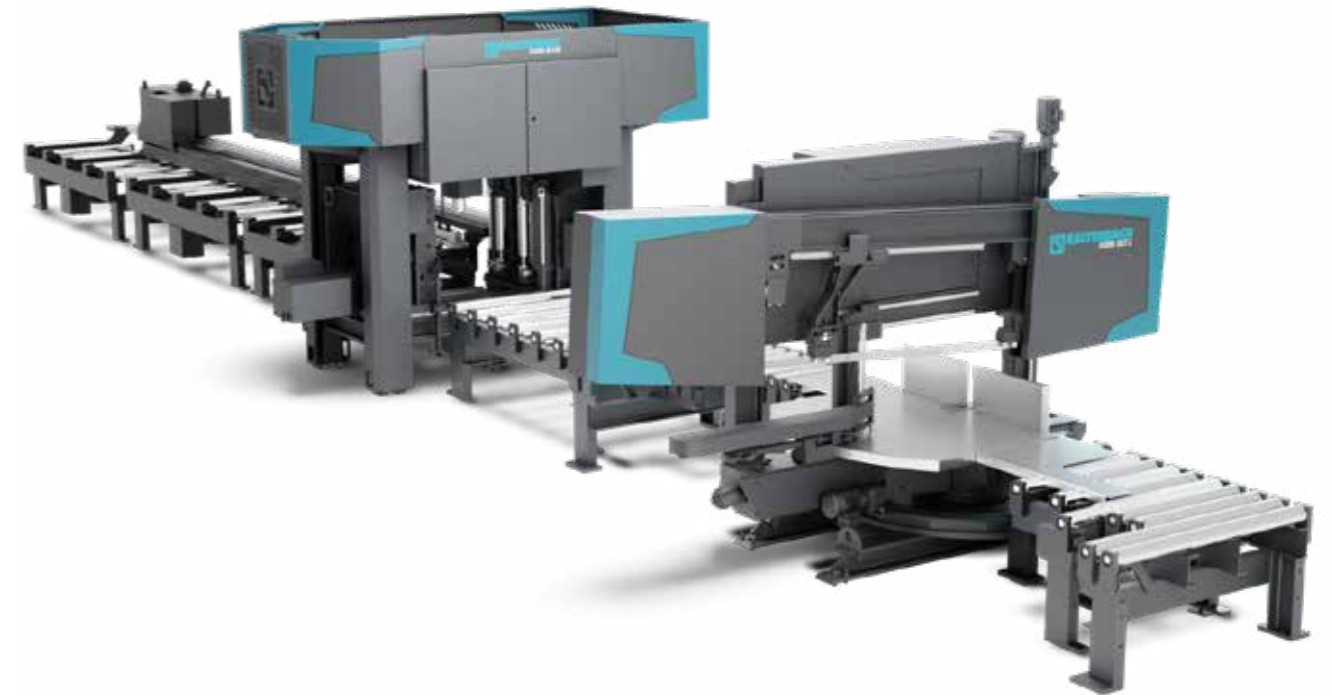

**KALTENBACH SAW DRILL COMBINATION KBP/KDP WITH SHORT PIECE GRIPPER**



- A remarkable quality and outstanding productivity on every job













# Markets

## AT HOME IN YOUR INDUSTRY

Process innovation, cost reduction, a safe and healthy environment are key elements in the various branches of steel processing. KALTENBACH has an in-dept knowledge of the challenges you have to deal with, worldwide.



### MARKETS

-  Automotive
-  Bridge Building
-  Crane Building
-  Locksmith's Shops
-  Machine Construction
-  Metal Construction
-  Ship Building
-  Steel Fabrication
-  Steel Service Center
-  Structural Engineering
-  Surface Treatment Service Center
-  Transmission Towers

■ State-of-the-art equipment, sustainable solutions. Contact our experts for advice and support.



■ Total design consultancy and customized solutions

## HIGH-PERFORMANCE PRODUCTION LINE FOR STEEL SERVICE CENTERS

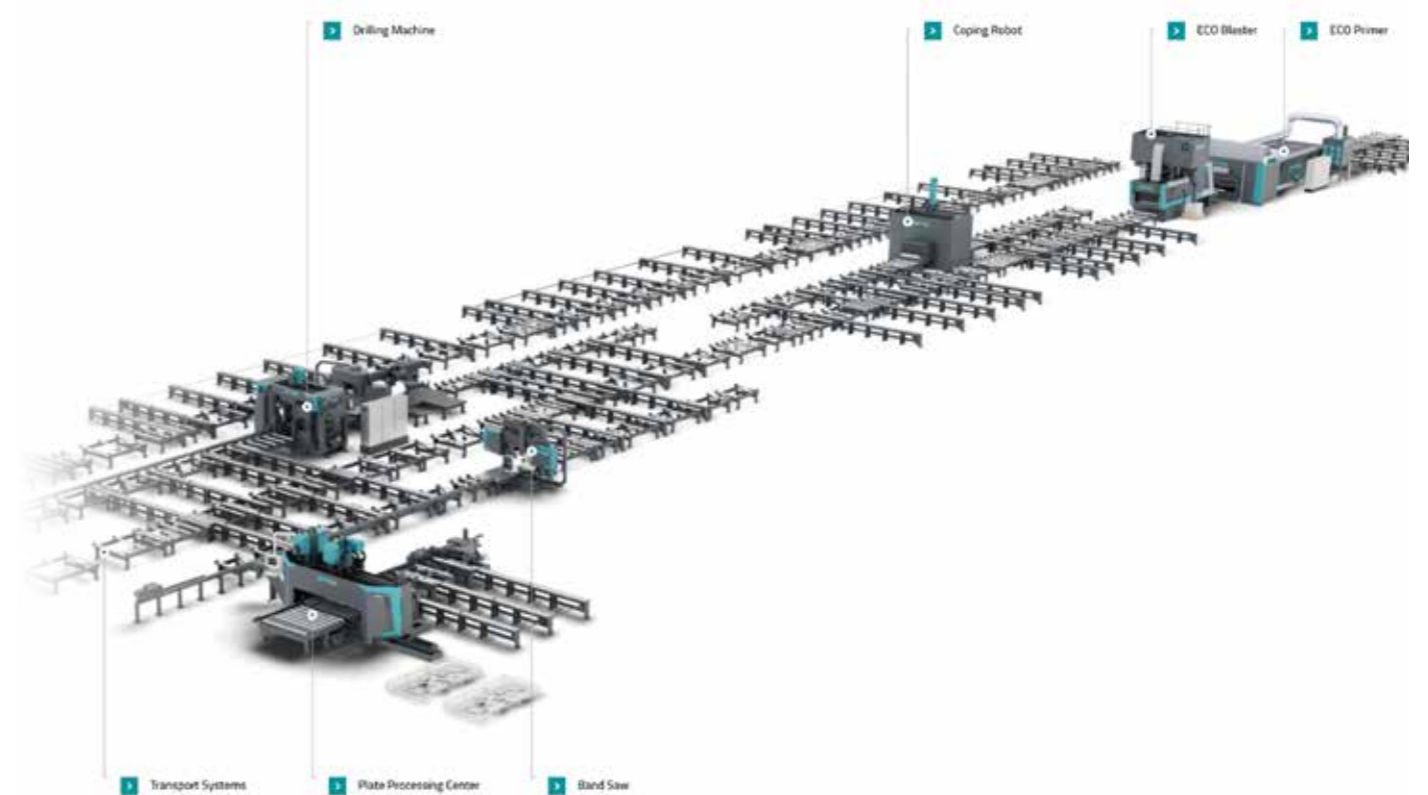

## COMPLETELY CUSTOMIZED SET-UP FOR STEEL FABRICATION FACTORIES

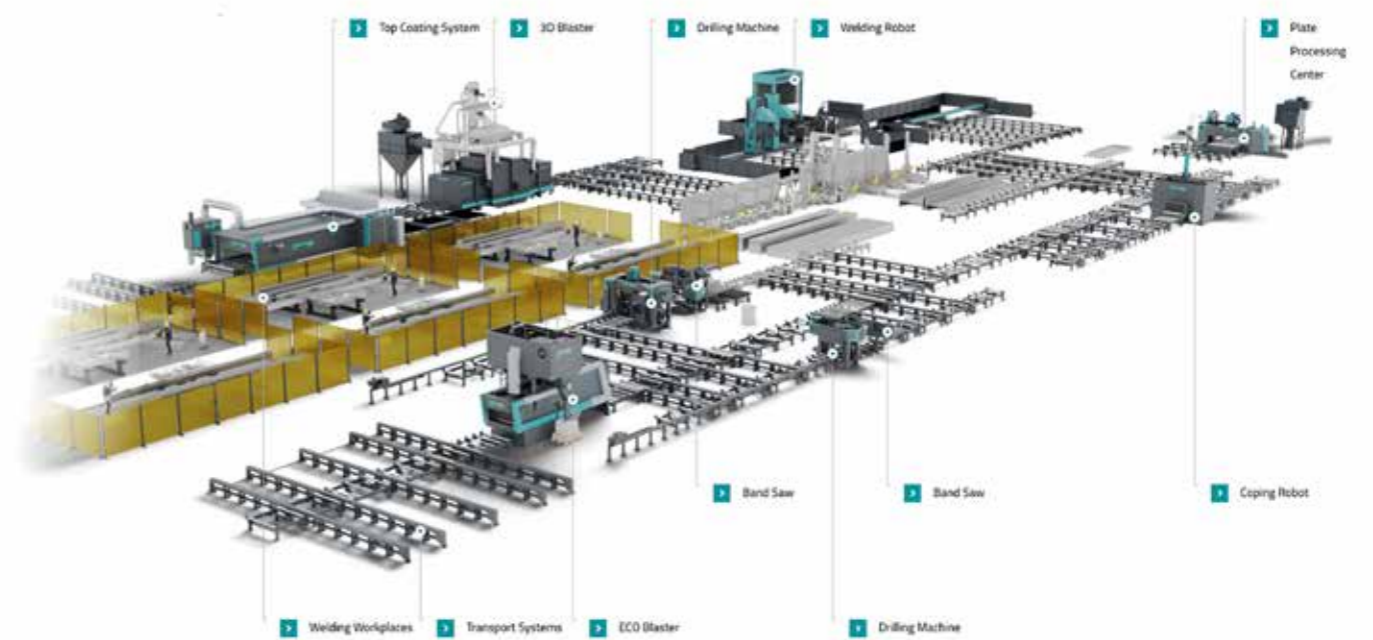

■ Our experts know your business and the challenges you have to face every day

# Automation

## AUTOMATED SOLUTIONS FOR EACH LEVEL OF REQUIREMENT

Process optimization and a wide range of automation possibilities enable an individual adjustment of production and transport processes, according to your requirements. From unique machine software to complete management information systems, KALTENBACH will be your system supplier. Please get in touch, anytime!



## INTELLIGENT AUTOMATION POSSIBILITIES

- > Creating valuable information on process optimization
- > Digital tracking and visualization of material in production
- > Complete management information on performance of the machine (uptime, energy consumption etc.)
- > Pro-active information on need for service and spare parts
- > Pro-active management of quality/material flow
- > Automated infeed/outfeed, transport and storage

## BENEFITS OF AUTOMATION

- > Low staffing requirements up to low staffed shifts
- > Faster material transport for higher tonnages
- > Full transparency about material position and production progress



# Service

## OPTIMAL AVAILABILITY AND PERFORMANCE

With 135 years in business, we are the experts in steel processing and surface treatment. Our custom made service solutions guarantee that you benefit from an optimal performance, availability and continuous high quality output of your investment.

### EXCELLENT PREVENTIVE MAINTENANCE PACKAGES

Maximum uptime can be ensured thanks to our excellent preventive maintenance packages. Together with you, our skilled engineers will keep your equipment up to date, improve your process efficiency and give advice to meet new market demands.

### ADVANCED PROCESS MONITORING SYSTEMS

With the help of advanced process monitoring systems, you will get a clear insight in your machine performance, and preventive maintenance can be planned in time.



### PROFESSIONAL HELPDESK

For fast and immediate assistance, you can rely on our help desk. Spare parts and assistance will be quickly on site, whenever and wherever needed.

### ORIGINAL SPARE PARTS AND STARTER KITS

Original spare parts stand for optimum efficiency, higher uptime and a longer service life of your machine. In order to safeguard production continuity and short down time, you can make use of various starter kits. In that case you will have all parts you need on stock.

### FIRST CLASS ASSISTANCE ON SITE

Knowledge, experience and a passionate commitment to support our customers in the best possible way is what makes our service strong. Together, we will look for the best manufacturing methods for your products.

### EFFECTIVE TRAINING

Taylor-made training programs will improve the productivity of your machine, as well as the skills of your employees.



## GET IN TOUCH WITH OUR SERVICE DEPARTMENT!

T +49 (0) 7621 175 244  
E [service@kaltenbach.de](mailto:service@kaltenbach.de)

Or check [www.kaltenbach.com](http://www.kaltenbach.com)

# Project approach

## TRUSTWORTHY PARTNERSHIPS



### PROJECT SPECIFICATION

Creating a clear scope of supply and functionality, including interfaces is always our basis. Taylor-made solutions.



### PROJECT MANAGEMENT

We are always with you, from the first approval of the project till site acceptance test, including preparations at your site.



### ENGINEERING

Product, process and production line. We will design a working and robust solution within the agreed specifications of the project.



### MANUFACTURING

Every day, our employees are dedicated and passionate about producing quality equipment that brings you an obvious added value.



### INSTALLATION AND COMMISSIONING

With our team of experts you will be assured of quick production starts and excellent knowledge transfer to your employees.



### AFTER SALES

Preventive maintenance, expert advice and extensive training, driven by a relentless focus on improving the quality and value of your installations.

# Contact us!

## WE ARE THERE - WHEREVER YOU NEED US

As technological leader in the field of steel processing systems, KALTENBACH excels in product quality, innovation and design. It is our passion to supply the most reliable solution against the lowest cost of ownership, worldwide.

This includes a clear focus on the environment and saving energy and material. With our latest automation devices, you will get an optimal insight into your production process. Operation and maintenance of our solutions will be easy and user-friendly. For all questions and in all cases you can rely on the fact, we are there. Wherever you need us.



#### ■ KALTENBACH GmbH + Co. KG

Blasiring 4,  
79539 Lörrach, Germany  
Telephone: +49 (0) 7621 175-0  
E-Mail: [info@kaltenbach.de](mailto:info@kaltenbach.de)

#### ■ KALTENBACH B.V. - GIETART

Pruisische Veldweg 20,  
7552 AC Hengelo, The Netherlands  
Telephone: +31 (0) 74 2452 452  
E-Mail: [info-nl@kaltenbach.com](mailto:info-nl@kaltenbach.com)

#### ■ KALTENBACH Constructions de Machines S.A.S.

Z.I. de la Doller, 6 Rue de la Plaine d'Alsace  
68520 Burnhaupt Le Haut, France  
Telephone: +33 3 89 48 99 89  
E-Mail: [commercial@kaltenbach.fr](mailto:commercial@kaltenbach.fr)

#### ■ KALTENBACH Ltd.

3 Caxton Park, Caxton Road  
Bedford, MK41 0TY, United Kingdom  
Telephone: +44 (1234) 213201  
E-Mail: [sales@kaltenbach.co.uk](mailto:sales@kaltenbach.co.uk)

#### ■ KALTENBACH Middle East FZC

P6-029 Saif Zone  
PO Box 122696, Sharjah, United Arab Emirates  
Telephone: +971 6 557 4624  
E-Mail: [info@kaltenbach.ae](mailto:info@kaltenbach.ae)

#### ■ KALTENBACH Ges.m.b.H.

Kremstraße 1  
4053 Haid-Ansfelden, Austria  
Telephone: +43 7229 81932  
E-Mail: [office@kaltenbach.co.at](mailto:office@kaltenbach.co.at)

#### ■ KALTENBACH Schweiz GmbH

Dättwilerstrasse 43  
5405 Baden-Dättwil, Switzerland  
Telephone: +41 56 4704030  
E-Mail: [info@kaltenbach-schweiz.ch](mailto:info@kaltenbach-schweiz.ch)

#### ■ KALTENBACH s.r.o.

Mestecko 9  
66461 Rajhrad u Brna, Czech Republic  
Telephone: +420549248077  
E-Mail: [info@kaltenbach.cz](mailto:info@kaltenbach.cz)

#### ■ KALTENBACH Machinery (Shanghai) Co. Ltd.

Yuzhou Plaza, 299. Jin Gang Lu, Rm. 1205,  
Pudong Yinqu, 201206 Shanghai, China  
Telephone: +86 21 5059 1560  
E-Mail: [info.china@kaltenbach.com](mailto:info.china@kaltenbach.com)

#### ■ KALTENBACH Asia PTE Ltd.

Block 439 Choa Chu Kang  
Avenue 4 #12-439, Singapore 680439  
Telephone: +65 6769 0261  
E-Mail: [kalten@singnet.com.sg](mailto:kalten@singnet.com.sg)

KALTENBACH reserves the right to bring changes in equipment, construction, and technical characteristics without preliminary notification. All rights reserved. No part of this publication may be reproduced in any form or by any means without prior permission in writing. Although care has been taken that the information in this publication is accurate, KALTENBACH does not accept any liability for errors or omissions.

[www.kaltenbach.com](http://www.kaltenbach.com)



# Convince yourself of the knowledge from 135 years of experience

With 135 years of experience in steel processing and surface treatment, KALTENBACH is able to face the challenge of a constantly changing global market with relentless innovation, high-quality process systems and an outstanding machine design.

Most environmentally friendly. Effective, safe and reliable. Our production lines and machines guarantee the right solution for any requirement in your business. Benefit from our industry expertise and generate added value - every day.

[www.kaltenbach.com](http://www.kaltenbach.com)

---

**Product videos:**

[www.youtube.com/kaltenbachGroup](https://www.youtube.com/kaltenbachGroup)

**Follow us on LinkedIn:**

[www.Linkedin.com/company/kaltenbach](https://www.Linkedin.com/company/kaltenbach)