

ENGLISH



ENGLISH



ENGLISH



ENGLISH

Installation and User Manual

version 1.02

TLKWF

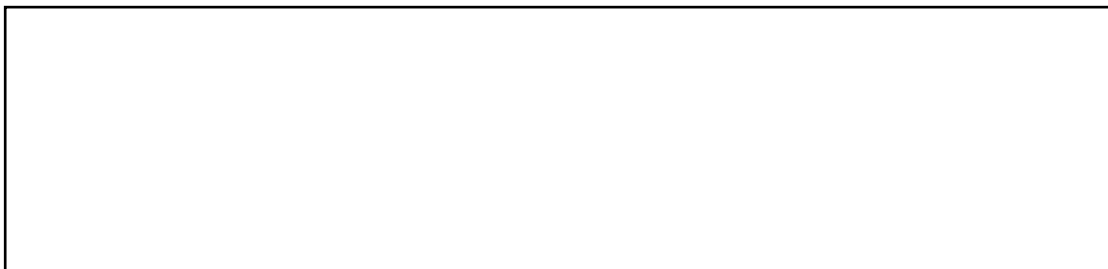

SYMBOLS

Here are the symbols used in the manual to draw the reader's attention:



Caution! Risk of electric shock.



Caution! This operation must be performed by skilled personnel.



Pay particular attention to the following instructions.



Further information.

WARRANTY

24 months from the date of the delivery note. Warranty covers only failures of defective components (due to construction defects or defects in materials) and includes replacement or repair of the components and related labor costs.

Warranty is automatically forfeited in the event of:

- tampering, deletion, removal of the identification label and/or serial number of the product
- misuse, transformation, alteration, repair of products not carried out by Laumas personnel

Laumas provides a 1-year warranty from the date of the delivery note on defects in material or manufacture of the battery.

GUIDELINES FOR PROPER DISPOSAL



**Sealed Lead Acid
Battery
Must be recycled
Properly**

This symbol on the product or packaging indicates that:

- This is electrical/electronic equipment and cannot be disposed of as municipal solid waste, but must be delivered to a recycling center
- Improper use or disposal can pollute the environment or damage human health
- Non-compliance with these guidelines will be penalized in accordance with the regulations in force in the country of destination
- It is recommended to dispose of the packing and packaging as required by local regulations

TABLE OF CONTENTS

USER WARNINGS	1
RECOMMENDATIONS FOR CORRECT INSTALLATION OF WEIGHING INSTRUMENTS ...	1
RECOMMENDATIONS FOR CORRECT INSTALLATION OF THE LOAD CELLS.....	2
LOAD CELL INPUT TEST (QUICK ACCESS)	4
LOAD CELL TESTING.....	4
MAIN SPECIFICATIONS OF THE INSTRUMENT	5
TECHNICAL SPECIFICATIONS	5
ELECTRICAL CONNECTIONS.....	6
BASIC INFORMATION.....	6
WIRING DIAGRAM.....	7
LED AND KEY FUNCTION	8
MENU MAP	9
SETPOINT	9
SYSTEM PARAMETERS	9
INSTRUMENT COMMISSIONING.....	10
PROGRAMMING OF SYSTEM PARAMETERS.....	11
THEORETICAL CALIBRATION.....	11
<i>MAXIMUM CAPACITY</i>	<i>12</i>
<i>TARE WEIGHT ZERO SETTING</i>	<i>12</i>
<i>ZERO VALUE MANUAL ENTRY.....</i>	<i>12</i>
REAL CALIBRATION (WITH SAMPLE WEIGHTS).....	13
FILTER ON THE WEIGHT	14
<i>ANTI PEAK.....</i>	<i>14</i>
ZERO PARAMETERS	15
<i>RESETTABLE WEIGHT SETTING FOR SMALL WEIGHT CHANGES.....</i>	<i>15</i>
<i>AUTOMATIC ZERO SETTING AT POWER-ON</i>	<i>15</i>
<i>ZERO TRACKING</i>	<i>15</i>
SETTING UNITS OF MEASURE.....	16
<i>DISPLAY COEFFICIENT</i>	<i>16</i>
NET FUNCTIONS	17
OUTPUTS AND INPUTS CONFIGURATION	18
SEMI-AUTOMATIC TARE (NET/GROSS).....	19
PRESET TARE (SUBTRACTIVE TARE DEVICE).....	20
SEMI-AUTOMATIC ZERO (WEIGHT ZERO-SETTING FOR SMALL VARIATIONS)	20
PEAK	21
SERIAL COMMUNICATION SETTING.....	21
<i>RS232 SERIAL COMMUNICATION</i>	<i>22</i>
<i>RS485 SERIAL COMMUNICATION</i>	<i>23</i>
<i>DIRECT CONNECTION BETWEEN RS485 AND RS232 WITHOUT CONVERTER</i>	<i>23</i>
WIFI COMMUNICATION SETTING	24
<i>CONNECTION TO PC BY VIRTUAL WIFI/ETHERNET PORT.....</i>	<i>29</i>

WEBSITE	30
REMOTE WEIGHT READING	32
WEIGHT READING VIA SERIAL PORT	33
RS485 CONNECTION	35
RS232 CONNECTION	35
WEIGHT READING VIA WIFI	36
TEST	38
ENERGY SAVING	38
INFO MENU	38
SETPOINT PROGRAMMING	39
USE WITH W SERIES INSTRUMENTS	40
CONNECTION TO THE WEIGHT INDICATOR	40
CONNECTION VIA RS485 PORT	40
CONNECTION VIA WIFI	40
ADDITIONAL MENU MAP	41
TLKWF REMOTE CONTROL	41
REMOTE KEYPAD LOCKING	42
ADDITIONAL ALARMS	42
ALARMS	43
ALARMS AND MESSAGES CONCERNING THE WIFI MODULE	44
OPTIONS	45
OPZBATTWF: INTERNAL BATTERY	45
BATEXT: EXTERNAL BATTERY	46
CONNECTING THE BATTERY TO THE INSTRUMENT	46
RESERVED FOR THE INSTALLER	47
MENU LOCKING	47
MENU UNLOCKING	47
TEMPORARY MENU UNLOCKING	47
SETTING UNLOCK PASSWORD	47
DATA DELETION AND PROGRAM SELECTION	47
KEYPAD OR DISPLAY LOCKING	48
DECLARATION OF CONFORMITY - EU	49
DECLARATION OF CONFORMITY - UKCA	50

USER WARNINGS

RECOMMENDATIONS FOR THE PROPER USE OF WEIGHING INSTRUMENT

- Keep away from heat sources and direct sunlight
- Repair the instrument from rain (except special IP versions)
- Do not wash with water jets (except special IP versions)
- Do not dip in water
- Do not spill liquid on the instrument
- Do not use solvents to clean the instrument
- Do not install in areas subject to explosion hazard (except special Atex versions)

RECOMMENDATIONS FOR CORRECT INSTALLATION OF WEIGHING INSTRUMENTS

The terminals indicated on the instrument's wiring diagram to be connected to earth must have the same potential as the weighed structure (same earthing pit or earthing system). If you are unable to ensure this condition, connect with an earthing wire the terminals of the instrument (including the terminal –SUPPLY) to the weighed structure.

The cell cable must be individually led to its panel input and not share a conduit with other cables; connect it directly to the instrument terminal strip without breaking its route with support terminal strips. Use "RC" filters on the instrument-driven solenoid valve and remote control switch coils.

Avoid inverters in the instrument panel; if inevitable, use special filters for the inverters and separate them with sheet metal partitions.

The panel installer must provide electric protections for the instruments (fuses, door lock switch etc.). It is advisable to leave the equipment always switched on to prevent the formation of condensation.

MAXIMUM CABLE LENGTHS

- RS485: 1000 metres with AWG24, shielded and twisted cables
- RS232: 15 metres for baud rates up to 19200

RECOMMENDATIONS FOR CORRECT INSTALLATION OF THE LOAD CELLS

SIZING OF LOAD CELLS CAPACITY

For safety reasons, in case of static weighing, it is advisable to use the load cells at a maximum of 70-80% of its nominal capacity (assuming that the load is uniformly distributed over the entire weighed structure); depending on the handling mode of the load to weigh, consider to further reduce the % of load with respect to the nominal capacity (ex.: forklifts handling, bridge cranes, etc.).

In case of weighing with dynamic loads, the installer has to estimate the thrust speed, the acceleration, the frequency, etc.

INSTALLING LOAD CELLS

The load cells must be placed on rigid, stable in-line structures; it is important to use the mounting modules for load cells to compensate for misalignment of the support surfaces.

CONNECTING SEVERAL CELLS IN PARALLEL

Connect several cells in parallel by using - if necessary - a watertight junction box with terminal box. The cell connection extension cables must be shielded, led individually into their piping or conduit and laid as far as possible from the power cables (in case of 4-wire connections, use cables with 4x1 mm² minimum cross-section).

PROTECTION OF THE CELL CABLE

Use water-proof sheaths and joints in order to protect the cables of the cells.

MECHANICAL RESTRAINTS (pipes, etc.)

When pipes are present, we recommend the use of hoses and flexible couplings with open mouthpieces with rubber protection; in case of hard pipes, place the pipe support or anchor bracket as far as possible from the weighed structure (at a distance at least 40 times the diameter of the pipe).

WELDING

Avoid welding with the load cells already installed. If this cannot be avoided, place the welder ground clamp close to the required welding point to prevent sending current through the load cell body.

WINDY CONDITIONS - KNOCKS – VIBRATIONS

The use of weigh modules is strongly recommended for all load cells to compensate for misalignment of the support surfaces. The system designer must ensure that the plant is protected against lateral shifting and tipping relating to: shocks and vibration; windy conditions; seismic conditions in the installation setting; stability of the support structure.

EARTHING THE WEIGHED STRUCTURE

By means of a copper wire with suitable cross-section, connect the cell upper support plate with the lower support plate, then connect all the lower plates to a single earthing system. Electrostatic charges accumulated because of the product rubbing against the pipes and the weighed container walls are discharged to the ground without going through or damaging the load cells. Failure to implement a proper earthing system might not affect the operation of the weighing system; this, however, does not rule out the possibility that the cells and connected instrument may become damaged in the future. It is forbidden to ensure earthing system continuity by using metal parts contained in the weighed structure.

FAILURE TO FOLLOW THE INSTALLATION RECOMMENDATIONS WILL BE CONSIDERED A MISUSE OF THE EQUIPMENT

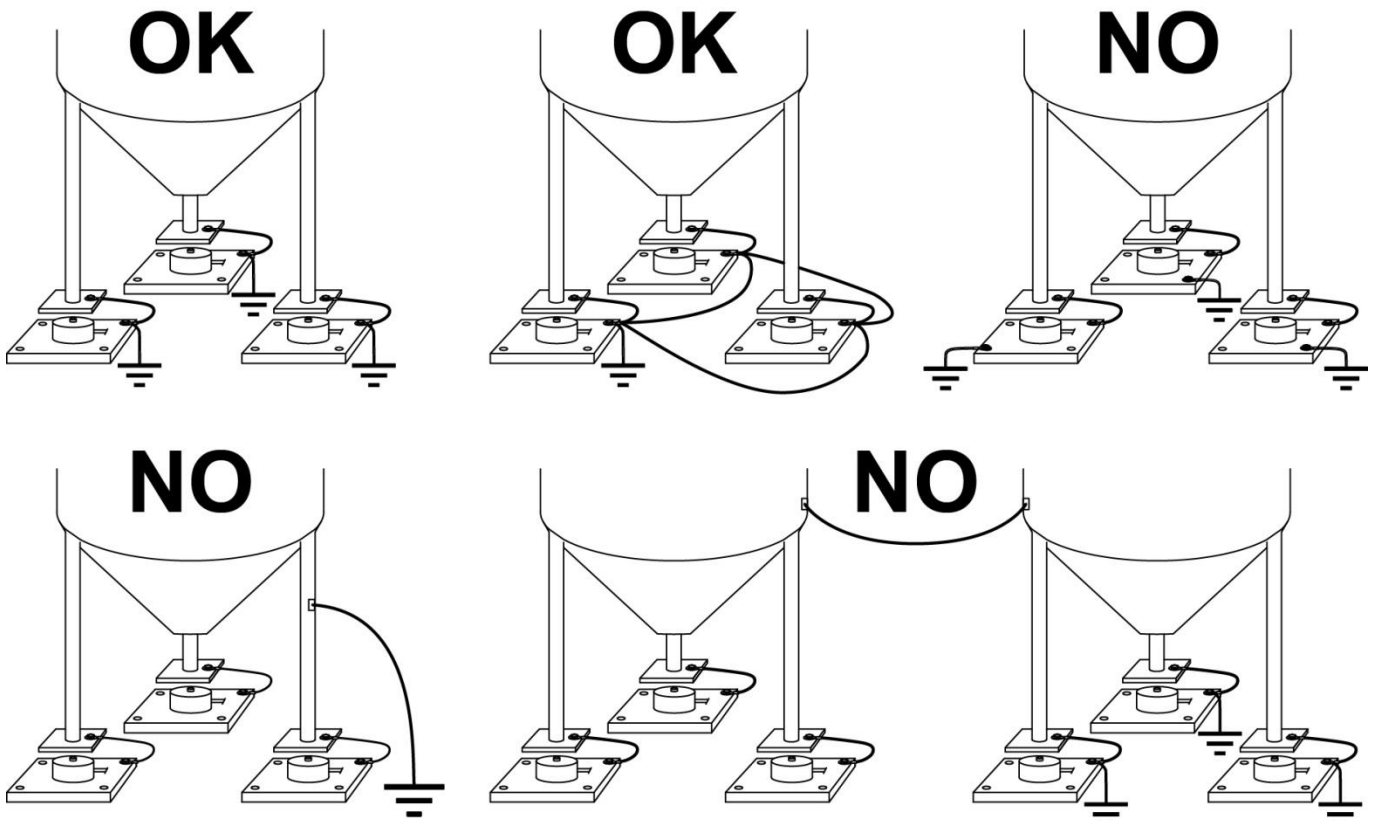

LOAD CELL INPUT TEST (QUICK ACCESS)

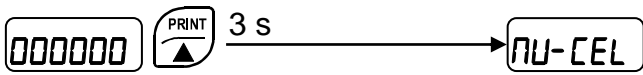

From the weight display, press  for 3 seconds; the response signal of the load cells is displayed, expressed in mV with four decimals.

LOAD CELL TESTING

Load cell resistance measurement (use a digital multimeter):

- Disconnect the load cells from the instrument and check that there is no moisture in the cell junction box caused by condensation or water infiltration. If so, drain the system or replace it if necessary.
- The value between the positive signal wire and the negative signal wire must be equal or similar to the one indicated in the load cell data sheet (output resistance).
- The value between the positive excitation wire and the negative excitation wire must be equal or similar to the one indicated in the load cell data sheet (input resistance).
- The insulation value between the shield and any other cell wire and between any other cell wire and the body of the load cell must be higher than 20 Mohm.

Load cell voltage measurement (use a digital multimeter):

- Take out the load cell to be tested from underneath the container, or alternatively, lift the container support.
- Make sure that the excitation of two wires of the load cell connected to the instrument (or amplifier) is 5 VDC $\pm 3\%$.
- Measure the response signal between the positive and the negative signal wires by directly connecting them to the tester, and make sure that it is comprised between 0 and ± 0.5 mV.
- Apply load to the cell and make sure that there is a signal increment.

IF ONE OF THE ABOVE CONDITIONS IS NOT MET, PLEASE CONTACT THE TECHNICAL ASSISTANCE SERVICE.

MAIN SPECIFICATIONS OF THE INSTRUMENT

Weight transmitter with 6-wire load cell input. Protection rating IP67. Dimensions: 170x80x65 mm; four fixing holes Ø 4 mm (centre distance 120x60 mm). Backlit alphanumeric LCD display, 38x16 mm viewing area, two-line by eight-digit (5 mm height). Six signalling LEDs. 4-key membrane keypad. Two serial ports (RS485 and RS232) for connection to: PC/PLC up to 32 instruments (max 99 with line repeaters) by ASCII Laumas, ModBus R.T.U., remote display protocol.

WiFi connectivity via serial protocols in tunnel mode and integrated web server for remote management.

The TLKWF can communicate with:

- Existing WiFi networks.
- PC, smartphone, tablet.
- Other TLKWF instruments.
- Other Laumas instruments equipped with WiFi option.

TECHNICAL SPECIFICATIONS

POWER SUPPLY and CONSUMPTION	12/24 VDC $\pm 10\%$; 2 W
NO. OF LOAD CELLS IN PARALLEL and SUPPLY	max 8 (350 ohm); 5 VDC / 120 mA
LINEARITY	< 0.01% F.S.
THERMAL DRIFT	< 0.0005% F.S./°C
A/D CONVERTER	24 bit (16000000 points)
MAX DIVISIONS (with measurement range ± 10 mV = sens. 2 mV/V)	± 999999 ; 0.01 μ V/d
MEASUREMENT RANGE	± 39 mV
MAX SENSITIVITY OF USABLE LOAD CELLS	± 7 mV/V
MAX CONVERSIONS PER SECOND	300 conversions/second
DISPLAY RANGE	± 999999
NO. OF DECIMALS / DISPLAY INCREMENTS	0÷4 / x 1 x 2 x 5 x 10 x 20 x 50 x 100
DIGITAL FILTER / READINGS PER SECOND	10 levels / 5÷300 Hz
RELAY LOGIC OUTPUTS	N. 4 – max 115 VAC; 150 mA
LOGIC INPUTS	N. 2 - 5-24 VDC PNP
SERIAL PORTS	RS485, RS232
BAUD RATE	2400, 4800, 9600, 19200, 38400, 115200
WIRELESS	WiFi module with serial protocols in tunnel mode and integrated web server
RANGE	about 100 meters line of sight
HUMIDITY (non condensing)	85%
STORAGE TEMPERATURE	-30°C +80°C
WORKING TEMPERATURE	-20°C +60°C

	RELAY OUTPUTS	N. 4 - max 30 VAC, 60 VDC; 150 mA
	WORKING TEMPERATURE	-20 °C +60 °C
	Equipment to be powered by 12-24 VDC LPS or Class 2 power source.	

ELECTRICAL CONNECTIONS

14 INPUTS TERMINAL

1	GND	13	RELAY OUTPUT No. 4
2	+SUPPLY (12/24 VDC)	14	DIGITAL OUTPUT COMMON
3	RS232: TXD		
4	RS232: RXD		
5	GND		
6	RS485 -		
7	RS485 +		
8	INPUT No. 1 (+VDC min 5 V max 24 V)		
9	INPUT No. 2 (+VDC min 5 V max 24 V)		
10	RELAY OUTPUT No. 1		
11	RELAY OUTPUT No. 2		
12	RELAY OUTPUT No. 3		

6 INPUTS TERMINAL

15	-LOAD CELL EXCITATION	18	-LOAD CELL REF/SENSE
16	+LOAD CELL EXCITATION	19	-LOAD CELL SIGNAL
17	+LOAD CELL REF/SENSE	20	+LOAD CELL SIGNAL

A flying connector is supplied for the power supply, which must be wired as follow (outer diameter of the cable: 6÷10 mm):

Flying connector	Power supply
1	GND
2	24 VDC



BASIC INFORMATION

- It is possible to supply up to eight 350 ohm load cells.
- For 4-wire load cells, make a jumper between EX- and REF- and between EX+ and REF+.
- In case of an RS485 network with several devices it is recommended to insert the 120 ohm termination resistance on the two devices located at the ends of the network, as described in the paragraph **RS485 SERIAL CONNECTION**.

WIRING DIAGRAM

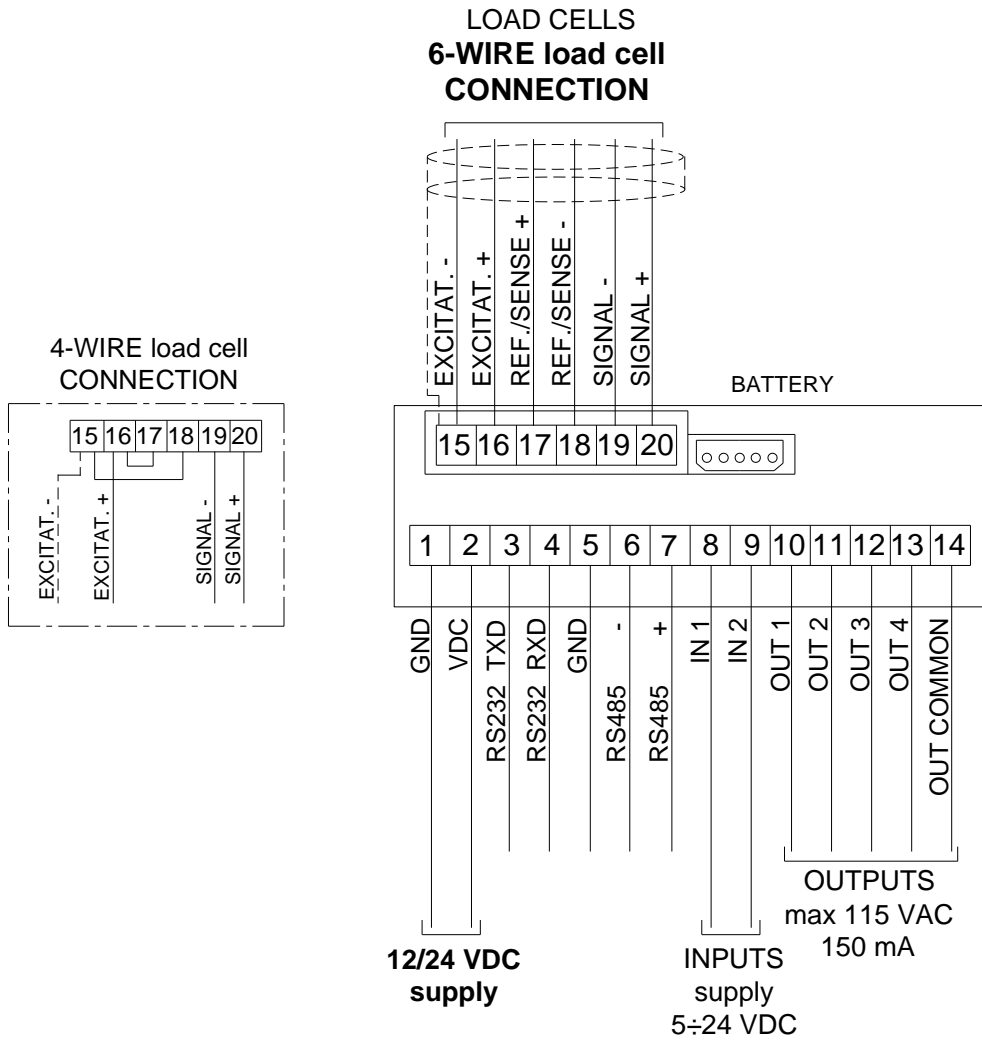











4 outputs: controlled by setpoint values or by remote device via protocol.

2 inputs: remote status reading, settable to have the following functions: **NET/GROSS WEIGHT**, **SEMI-AUTOMATIC ZERO**, **PEAK** (see section **OUTPUTS AND INPUTS CONFIGURATION**).

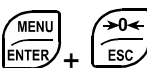
LED AND KEY FUNCTION

LED	Main function	Secondary function *
NET	net weight (semi-automatic tare or preset tare)	LED lit: input 1 closed
→0←	zero (deviation from zero not more than ±0.25 divisions)	LED lit: input 2 closed
▾	stability	LED lit: output 1 closed
kg	unit of measure: kg	LED lit: output 2 closed
g	unit of measure: g	LED lit: output 3 closed
L	unit of measure other than kg or g	LED lit: output 4 closed

*) To activate the secondary LED function, during weight display press and hold down **MENU** and **▲** keys at the same time (press **MENU** immediately followed by **▲**).

KEY	Short press	Long press (3 s)	Into menus
	Semi-automatic zero	Tare resetting	Cancel or return to previous menu
	Gross → Net	Net → Gross	Select figure to be modified or go to previous menu item.
		mV load cell test	Modify selected figure or go to next menu item
	Setting setpoint and hysteresis		Confirm or enter in submenu
	Setting general parameters (press  immediately followed by )		
	Setting preset tare (press  immediately followed by )		



Into menus LEDs light up in sequence to indicate that it is not displaying a weight.

MENU MAP

Into menus changes are applied right after pressing the **ENTER** key (no further confirmation is required).

SETPOINT

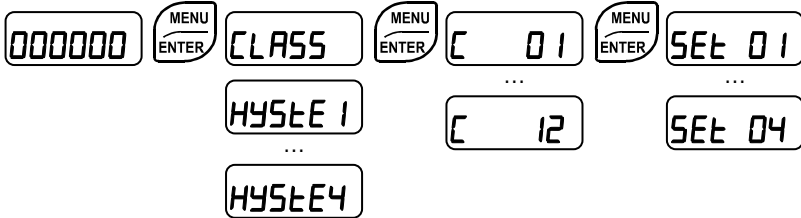

SYSTEM PARAMETERS

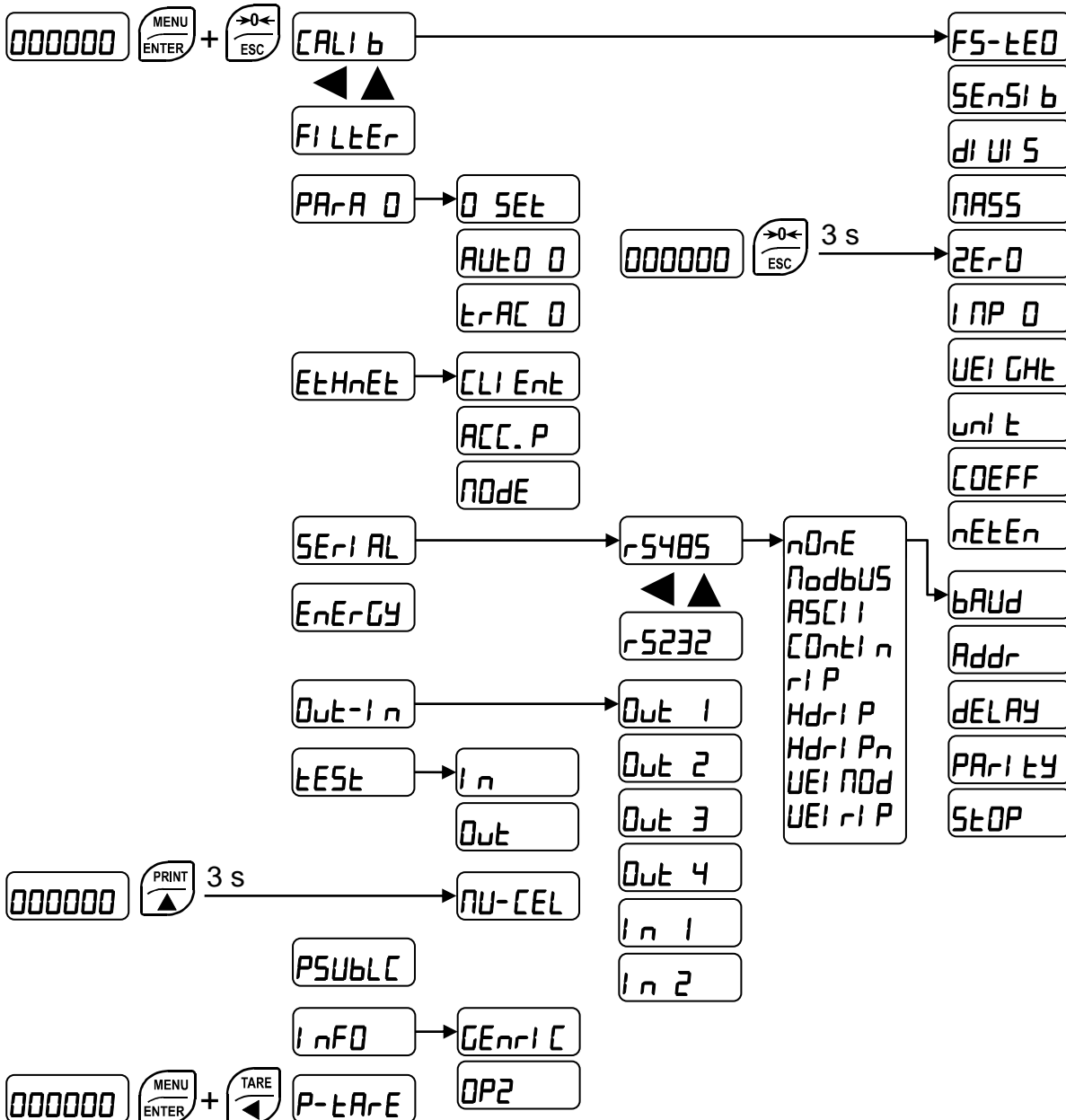

INSTRUMENT COMMISSIONING

Upon switch-on, the display shows in sequence:

- *111111* → *999999* (ONLY in case of approved program);
- instrument model (e.g.: *ELHUF*);
- *SU* followed by the software code (e.g.: *SU 50*);
- program type: *BASE* (base);
- *r* followed by the software version (e.g.: *r 1.01.00*);
- *HU* followed by the hardware code (e.g.: *HU 560*);
- serial number (e.g.: *1605 15*);

Check that the display shows the weight and that when loading the load cells there is an increase in weight. If there is not check and verify the connections and correct positioning of the load cells.

- **If the instrument has already been theoretical CALIBRATED** (plant system identification tag present on the instrument and on the cover: load cell's rated data already entered):
 - Reset to zero (see section **TARE WEIGHT ZERO SETTING**)
 - Check the calibration with sample weights and correct the indicated weight if necessary (see section **REAL CALIBRATION (WITH SAMPLE WEIGHTS)**).
- **If the instrument HAS NOT BEEN CALIBRATED** (missing plant system identification tag) proceed with calibration:
 - If load cells data are unknown, follow the procedure in section **REAL CALIBRATION (WITH SAMPLE WEIGHTS)**
 - Enter the rated data of load cells following the procedure given in section **THEORETICAL CALIBRATION**
 - Reset to zero (see section **TARE WEIGHT ZERO SETTING**)
 - Check the calibration with sample weights and correct the indicated weight if necessary (see section **REAL CALIBRATION (WITH SAMPLE WEIGHTS)**).
- If you use serial communication, set the related parameters (see section **SERIAL COMMUNICATION SETTING**).
- If you use WiFi communication, set the related parameters (see section **WIFI COMMUNICATION SETTING**)
- If setpoint are used, set the required weight values and the relevant parameters (see sections **SETPOINT PROGRAMMING** and **OUTPUTS AND INPUTS CONFIGURATION**).

PROGRAMMING OF SYSTEM PARAMETERS

From the weight display, press simultaneously keys **MENU** and **ESC** to access the parameter setting.

MENU/ENTER: to enter a menu/confirm the data entry.

▲: to modify the displayed figure or menu item.

◀: to select a new figure or modify the displayed menu item.

ESC: to cancel and return to the previous menu.

THEORETICAL CALIBRATION

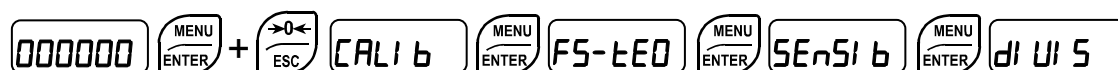

This function allows the load cell rated values to be set.

To perform the theoretical calibration set the following parameters in sequence:

- **FS-tEO** (default: **dEΠo**): the **system full scale** is given by one cell capacity multiplied by the number of cells used. Example: 4 cells of 1000 kg → FULL SCALE = 1000 x 4 = 4000. The instrument is supplied with a theoretical full scale value **dEΠo** corresponding to 10000. To restore factory values, set 0 as full scale.
- **SErSI b** (default: 2.00000 mV/V): **sensitivity** is a load cell rated parameter expressed in mV/V. Set the average sensitivity value indicated on the load cells. It's possible to set a value between 0.50000 and 7.00000 mV/V. Example of 4-cell system with sensitivity: 2.00100, 2.00150, 2.00200, 2.00250; enter 2.00175, calculated as $(2.00100 + 2.00150 + 2.00200 + 2.00250) / 4$.
- **dI UI S**: the **division** (resolution) is the minimum weight increment value which can be displayed. It is automatically calculated by the system according to the performed calibration, so that it is equal to 1/10000 of full scale. It can be changed and be variable between 0.0001 and 100 with x1 x2 x5 x10 increments.



- By modifying the theoretical full scale, the sensitivity or divisions, the real calibration is cancelled and the theoretical calibration only is considered valid.
- If the theoretical full scale and the recalculated full scale in real calibration (see section **REAL CALIBRATION (WITH SAMPLE WEIGHTS)**) are equal, this means that the calibration currently in use is theoretical; if they are different, the calibration in use is the real calibration based on sample weights.
- By modifying the theoretical full scale, the sensitivity or divisions, the system's parameters containing a weight value will be set to default values (setpoint, hysteresis, etc.).

MAXIMUM CAPACITY

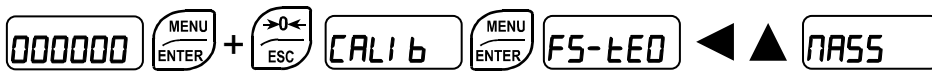

nASS: maximum displayable weight (from 0 to full scale; default: 0). When the weight exceeds this value by 9 divisions, the display shows "-----". To disable this function, set 0.

TARE WEIGHT ZERO SETTING





This menu may also be accessed directly from the weight display, holding down the  key for 3 seconds.

Perform this procedure after having set the **THEORETICAL CALIBRATION** data.

Use this function to set to zero the weight of the empty system after commissioning and then later on to compensate zero variations due to the presence of product residues.

Procedure:

- Confirm the message **zEr 0** by pressing .
- The weight value to be set to zero is displayed. In this phase all of the LEDs are flashing.
- Confirming once again, the weight is set to zero (the value is stored to the permanent memory).
- Press  to display the value of the total weight reset by the instrument, given by the sum of all of the previous zero settings.

ZERO VALUE MANUAL ENTRY



WARNING: perform this procedure only if it's not possible to reset the weighed structure tare, for example because it contains product that cannot be unloaded.

Set in this parameter the estimated zero value (from 0 to 999999; default: 0).

REAL CALIBRATION (WITH SAMPLE WEIGHTS)



After having performed the THEORETICAL CALIBRATION and TARE WEIGHT ZERO SETTING, this function allows correct calibration to be done using sample weights of known value and, if necessary, any deviations of the indicated value from the correct value to be corrected.

Load onto the weighing system a sample weight, which must be **at least 50%** of the maximum quantity to be weighed.

By confirming the message **UEI GHe** the flashing value of the weight currently on the system is displayed. In this phase all of the LEDs are off. Adjust the value on display by using the arrow keys if necessary. After confirming, the new set weight will appear with all the LEDs flashing. After an additional confirmation, the message **UEI GHe** will be restored and by repeatedly pressing the key **ESC** the weight will once again be displayed.

Example: for a system of maximum capacity 1000 kg and 1 kg division, two sample weights are available, one of 500 kg and the other one of 300 kg. Load both weights onto the system and correct the indicated weight to 800. Now remove the 300 kg weight, the system must show 500; remove the 500 kg weight too; the system must read zero. If this does not happen, it means that there is a mechanical problem affecting the system linearity.

WARNING: identify and correct any mechanical problems before repeating the procedure.



- If theoretical full scale and recalculated full scale in real calibration are equal, it means that the theoretical calibration is currently in use; otherwise, the real calibration based on sample weights is in use.
- If the correction made changes the previous full scale for more than 20%, all the parameters with settable weight values are reset to default values.

LINEARISATION OPTION ON MAX 5 POINTS:

It is possible to perform a linearisation of the weight repeating the above-described procedure up to a maximum of five points, using five different sample weights. The procedure ends by pressing the **ESC** button or after entering the fifth value; at this point it will no longer be possible to change the calibration value, but only to perform a new real calibration. To perform a new calibration, should return to the weight display and then re-entering into the calibration menu.

By pressing **▲** after having confirmed the sample weight that has been set, the full scale appears, recalculated according to the value of the maximum sample weight entered and making reference to the cell sensitivity set in the theoretical calibration (**SEnSi b**).

FILTER ON THE WEIGHT



Setting this parameter allows a stable weight display to be obtained.

To increase the effect (weight more stable) increase the value (from 0 to 9, default 4).

As seen in the diagram:

- By confirming the *FILTER* message, the currently programmed filter value is displayed.
- By changing and confirming the value, the weight is displayed and it will be possible to experimentally verify its stability.
- If stability is not satisfactory, confirming brings back the message *FILTER* and the filter may be modified again until an optimum result is achieved.

The filter enables to stabilise a weight as long as its variations are smaller than the corresponding “response time”. It is necessary to set this filter according to the type of application and to the full scale value set.

FILTER VALUE	Response times [ms]	Display and serial port refresh frequency [Hz]
0	12	300
1	150	100
2	260	50
3	425	25
4 (default)	850	12.5
5	1700	12.5
6	2500	12.5
7	4000	10
8	6000	10
9	7000	5

ANTI PEAK

When the weight is stable, the anti-peak filter removes any sudden disturbances with a maximum duration of 1 second. Confirm the filter on the weight with **ENTER** and select one of the following options:

- *ANTIPEAK*: anti peak filter enabled (default);
- *ANTIPEAKOFF*: anti peak filter disabled.

ZERO PARAMETERS



RESETTABLE WEIGHT SETTING FOR SMALL WEIGHT CHANGES

0 SEt (from 0 to full scale; default: 300; considered decimals: 300 – 30.0 – 3.00 – 0.300): this parameter indicates the maximum weight value resettable by external contact, keypad or serial protocol.

AUTOMATIC ZERO SETTING AT POWER-ON

AUt0 0 (from 0 to 10% of full scale; default: 0): if at switch-on the weight value is lower than the value set in this parameter, the weight is reset. To disable this function, set 0.

ZERO TRACKING

t-rAC 0 (from 1 to 5, default: n0nE): when the weight value is stable and, after a second, it deviates from zero by a figure in divisions smaller or equal to the figure in divisions set in this parameter, the weight is set to zero. To disable this function, set n0nE.

Example: if the parameter **dI U! S** is set to 5 and **t-rAC 0** is set to 2, the weight will be automatically set to zero for variations smaller than or equal to 10 (**dI U! S** x **t-rAC 0**).

SETTING UNITS OF MEASURE



These are the available units of measure:

HI LOG:	kilograms
G:	grams
t:	tons
Lb:	pounds*
nEUton:	newtons*
LI t r E:	litres*
bAr:	bars*
Atm:	atmospheres*
PIECE:	pieces*
nEU- π :	newton metres*
HI LO- π :	kilogram metres*
Other:	other generic units of measure not included in the list*



For the units marked with * it's possible to set also the display coefficient (parameter **COEFF**, see the related section). To use **COEFF** is necessary to enable it, closing the **COEFF** input (see section **OUTPUTS AND INPUTS CONFIGURATION**).

DISPLAY COEFFICIENT



By setting the coefficient **COEFF** the display is changed accordingly.

If one of the inputs is set to **COEFF** mode (see section **OUTPUTS AND INPUTS CONFIGURATION**) when the input is closed the value will be displayed modified according to the **COEFF** coefficient; when the input is opened the standard weight display will be restored.

COEFF: (max settable value: 99.9999; default: 1.0000) will have different meanings according to the value set in **unit t**, i.e. the selected unit of measure. (see section **SETTING UNITS OF MEASURE**).

If the unit of measure chosen is:

Lb: pounds, the value set in **COEFF** will be multiplied by the weight value currently displayed;

nEUton: newton, the value set in **COEFF** will be multiplied by the weight value currently displayed;

LITRE: litres, in **COEFF** set the specific weight in kg/l, assuming that the system is calibrated in kg;

BAR: bar, the value set in **COEFF** will be multiplied by the weight value currently displayed;

ATM: atmosphere, the value set in **COEFF** will be multiplied by the weight value currently displayed;

PIECE: pieces, in **COEFF** set the weight of one piece;

nEU-N: newton metres, the value set in **COEFF** will be multiplied by the weight value currently displayed;

HILO-N: kilogram metres, the value set in **COEFF** will be multiplied by the weight value currently displayed;

OTHER: generic unit of measure not included in the list, the value set in **COEFF** will be multiplied by the weight value currently displayed.



WARNING: All other settings (setpoint, hysteresis, calibration ...) are expressed in weight value. If you want to convert them to the new unit of measurement, perform one of the following procedures for changing the system calibration.

The parameter **COEFF** must remain set to 1.0000.

THEORETICAL CALIBRATION'S CHANGE FOR OTHER UNITS OF MEASURE

Set in the parameter **F5-LEO** the F.SCALE value divided by the conversion coefficient from kg to the new unit of measure.

Example: The 4 load cells of 1000 kg are placed under a scale for olive oil, which has a specific gravity of 0.916 kg/l. Setting the F.SCALE = $(4 \times 1000) / 0.916 = 4367$, the system works in liters of olive oil.

Also, if you set the parameter **UNIT = LITRE** (see section **SETTING UNITS OF MEASURE**), the system will display and print the symbol "l" instead of "kg".

REAL CALIBRATION'S CHANGE FOR OTHER UNITS OF MEASURE

Load a known quantity of product litres on the scale (equal to at least 50% of the maximum amount that you must weigh) and enter in the parameter **UEI GHT**, the product loaded value in litres. Also, if you set the parameter **UNIT = LITRE** (see section **SETTING UNITS OF MEASURE**), the system will display and print the symbol "l" instead of "kg".

NET FUNCTIONS



Enables or disables the semiautomatic tare and preset tare functions:

ENABLE: net functions enabled (default).

DISABLE: net functions disabled.

OUTPUTS AND INPUTS CONFIGURATION

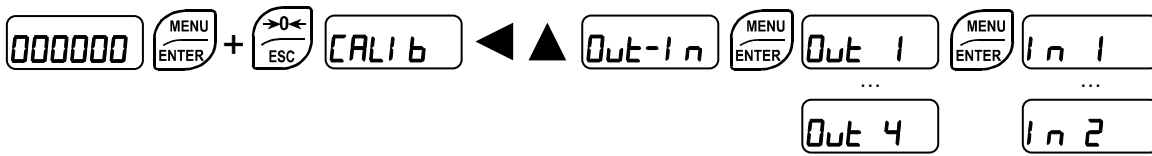

OUTPUTS

The outputs are set by default as follows: *DPE_n / SEt / GrOSS / POS_nEG / OFF*.

Possible operation modes:

- **DPE_n (normally open)**: the relay is de-energised and the contact is open when the weight is lower than the programmed setpoint value; it closes when the weight is higher than or equal to the programmed setpoint value.
- **CLDSE (normally closed)**: the relay is energised and the contact is closed when the weight is lower than the programmed setpoint value; it opens when the weight is higher than or equal to the programmed setpoint value.
- **SEt**: the contact will switch on the basis of weight, according to setpoint (see section **SETPOINT PROGRAMMING**).
- **PLC**: the contact will not switch on the basis of weight, but is controlled by remote protocol commands.
- **StAbLE**: relay switching occurs when the weight is stable.

If the operation mode *SEt* is selected, the following options are also active:

- **GrOSS**: the contact will switch on the basis of gross weight.
- **nEt**: the contact will switch on the basis of net weight (If the net function is not active, the contact will switch on the basis of gross weight).
- **POS_nEG**: relay switching occurs for both positive and negative weight values.
- **POS**: relay switching occurs for positive weight values only.
- **nEG**: relay switching occurs for negative weight values only.

By confirming with ENTER the setpoint operation can be set to the value 0:

- **OFF**: relay switching will not occur if the setpoint value is 0.
- **0_n**:
 - setpoint = 0 and switching = **POS_nEG**: relay switching occurs when the weight is 0; the relay will switch again when the weight is different from zero, taking hysteresis into account (both for positive and for negative weights).
 - setpoint = 0 and switching = **POS**: relay switching occurs for a weight higher than or equal to 0, the relay will switch again for values below 0, taking hysteresis into account.
 - setpoint = 0 and switching = **nEG**: relay switching occurs for a weight lower than or equal to 0, the relay will switch again for values above 0, taking hysteresis into account.

INPUTS

Default: input 1 = ZER0 input 2 = NET-G

Possible operation modes:

- NET-G (NET/GROSS): by closing this input for no more than one second, it's making an operation of SEMI-AUTOMATIC TARE and the display will show the net weight. To display the gross weight again, hold the NET/GROSS input closed for 3 seconds.
- ZER0: by closing the input for no more than one second, the weight is set to zero (see section **WEIGHT ZERO-SETTING FOR SMALL VARIATIONS (SEMI-AUTOMATIC ZERO)**).
- PEAK: keeping the input closed the maximum weight value reached remains on display. Opening the input the current weight is displayed.
- PLC: closing the input no operation is performed, the input status may however be read remotely by way of the communication protocol.
- CONT: closing the input for max one second the weight is transmitted over the serial connection according to the fast continuous transmission protocol only once (**only if CONT is set in the item SERIAL**).
- COEFF: when the input is closed the weight is displayed based on the set coefficient (see setting of the units of measure and coefficient), otherwise the weight is displayed.

SEMI-AUTOMATIC TARE (NET/GROSS)



THE SEMI-AUTOMATIC TARE OPERATION IS LOST UPON INSTRUMENT POWER-OFF.

To perform a net operation (SEMI-AUTOMATIC TARE), close the NET/GROSS input or press the **TARE** key for less than 3 seconds. The instrument displays the net weight (just set to zero) and the NET LED lights up. To display the gross weight again, keep the NET/GROSS input closed or press **TARE** for 3 seconds.

This operation can be repeated many times by the operator to allow the loading of several products.

Example:

Put the box on the scale, the display shows the box weight; press **TARE**, the display shows the net weight to zero; introduce the product in the box, the display shows the product weight. This operation can be repeated several times.



While the net weight is displayed, keep  pressed to display gross weight. When the key is released the net weight will be displayed again.

The semi-automatic tare operation is not allowed if the gross weight is zero.

PRESET TARE (SUBRACTIVE TARE DEVICE)

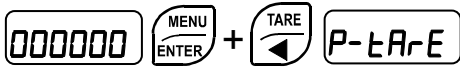

It is possible to manually set a preset tare value to be subtracted from the display value provided that the $P-tAr-E \leq \text{max capacity}$ condition is verified.

By default the instrument shows the last programmed preset tare value: to apply it press  and then **ENTER**.

After setting the tare value, going back to the weight display, the display shows the net weight (subtracting the preset tare value) and the NET LED lights up to show that a tare has been entered. To delete a preset tare and return to gross weight display, hold down **TARE** for about 3 seconds or keep the NET/GROSS input (if any) closed for the same length of time (3 seconds). The preset tare value is set to zero. The NET LED is turned off when the gross weight is displayed once again.



While the net weight is displayed, keep  pressed to display the gross weight. When the key is released the net weight will be displayed again.



- IF A SEMI-AUTOMATIC TARE (NET) IS ENTERED, IT IS NOT POSSIBLE TO ACCESS THE ENTER PRESET TARE FUNCTION.
- IF A PRESET TARE IS ENTERED, IT'S STILL POSSIBLE TO ACCESS THE SEMI-AUTOMATIC TARE (NET) FUNCTION. THE TWO DIFFERENT TYPES OF TARE ARE ADDED.



ALL THE SEMI-AUTOMATIC TARE (NET) AND PRESET TARE FUNCTIONS WILL BE LOST WHEN THE INSTRUMENT IS TURNED OFF.

SEMI-AUTOMATIC ZERO (WEIGHT ZERO-SETTING FOR SMALL VARIATIONS)

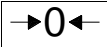
By closing the SEMI-AUTOMATIC ZERO input, the weight is set to zero; alternatively, by pressing the  key for less than 3 seconds, the **SEt** message is displayed for 3 seconds, by pressing **ENTER** the weight is set to zero.

This function is only allowed if the weight is lower than the $0 SEt$ value (see section **RESETTABLE WEIGHT SETTING FOR SMALL WEIGHT CHANGES**), otherwise the alarm **E-----** appears and the weight is not set to zero.



The zero-setting is lost upon instrument power-off.

PEAK

By keeping the PEAK input closed the maximum weight value reached remains displayed. By opening the input the current weight is displayed.



If you wish to use this input to view a sudden variation peak, set the FILTER ON THE WEIGHT to 0.

SERIAL COMMUNICATION SETTING



- *r5485 / r5232*: communication port.
 - *nOnE*: it disables any type of communication (default).
 - *ModBUS*: MODBUS-RTU protocol; possible addresses: from 1 to 99 (see Communication protocols manual).
 - *ASCI I*: ASCII bidirectional protocol; possible addresses: from 1 to 99 (see Communication protocols manual).
 - *NOdU60*
 - *NOd t d*
 - *COntI n*: continuous weight transmission protocol (see Communication protocols manual), at the frequency set in *HEr t 2* item (from 10 to 300).
 - *NOd t* (set: *PARI t Y* = *nOnE*, *StOP* = 1).
 - *NOd t d* (set: *PARI t Y* = *nOnE*, *StOP* = 1).
 - *rI P*: continuous weight transmission protocol to RIP5/20/60, RIP50SHA, RIPLD series remote displays; the remote display shows the net weight or gross weight according to its settings (set: *bAUd* = 9600, *PARI t Y* = *nOnE*, *StOP* = 1).
 - *Hdri P*: continuous weight transmission protocol to RIP6100, RIP675, RIP6125C series remote displays; the remote display shows the net weight or gross weight according to its settings (set: *bAUd* = 9600, *PARI t Y* = *nOnE*, *StOP* = 1).
 - *Hdri Pn*: continuous weight transmission protocol to RIP6100, RIP675, RIP6125C series remote displays (set: *bAUd* = 9600, *PARI t Y* = *nOnE*, *StOP* = 1).
When the remote display is set to gross weight:
 - if the instrument displays the gross weight, the remote display shows the gross weight.
 - if the instrument shows the net weight, the remote display shows the net weight alternated with the message *nEt*.
 - *UEI NOd*: weight reception mode (see section **WEIGHT READING VIA SERIAL PORT**).
 - *UEI rI P*: weight reception mode (see section **WEIGHT READING VIA SERIAL PORT**).
 - *bAUd*: transmission speed (2400, 4800, 9600, 19200, 38400, 115200; default: 9600).
 - *Addr*: instrument address (from 1 to 99; default: 1).

- **HEFEZ**: maximum transmission frequency (10 – 20 – 30 – 40 – 50 – 60 – 70 – 80 – 100 – 200 – 300; default: 10); to be set when the **COntrol** transmission protocol is selected.

Maximum setting frequency (**HEFEZ**):

- 20 Hz with minimum baud rate 2400 baud.
- 40 Hz with minimum baud rate 4800 baud.
- 80 Hz with minimum baud rate 9600 baud.
- 100 Hz with minimum baud rate 19200 baud.
- 200 Hz with minimum baud rate 38400 baud.
- 300 Hz with minimum baud rate 38400 baud.
- **DELAY**: delay in milliseconds which elapses before the instrument replies (from 0 to 200 ms; default: 0).
- **PARITY**:
 - **none**: no parity (default).
 - **EVEN**: even parity.
 - **Odd**: odd parity.
- **STOP**: stop bit (1 – 2; default: 1).



For more information about protocols and methods of communication, request the proper manual to technical assistance.

RS232 SERIAL COMMUNICATION

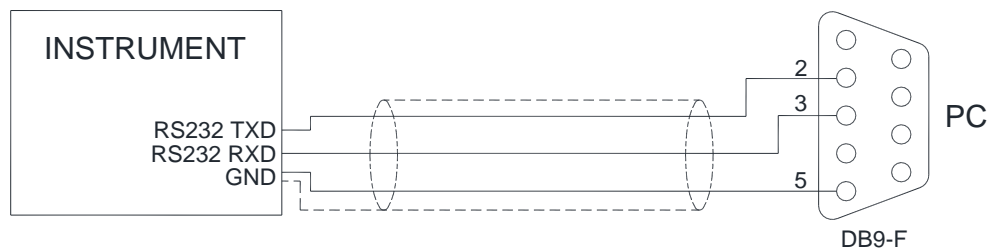

RS485 SERIAL COMMUNICATION

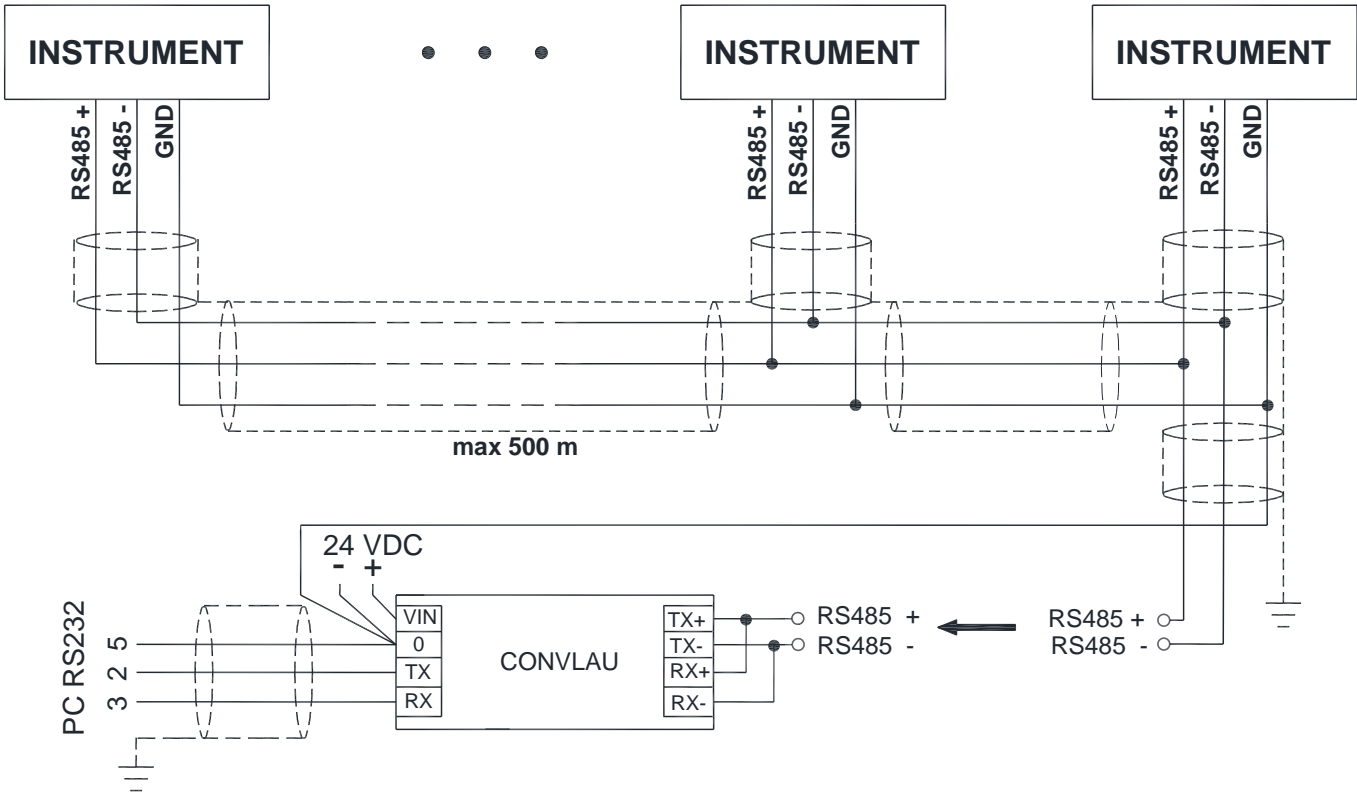

If the RS485 network exceeds 100 metres in length or baud-rate over 9600 are used, two terminating resistors are needed at the ends of the network. Two 120 ohm resistors must be connected between the “+” and “-” terminals of the line, on the terminal strip of the furthest instruments. Should there be different instruments or converters, refer to the specific manuals to determine whether it is necessary to connect the above-mentioned resistors.

DIRECT CONNECTION BETWEEN RS485 AND RS232 WITHOUT CONVERTER

Since a two-wire RS485 output may be used directly on the RS-232 input of a PC or remote display, it is possible to implement instrument connection to an RS-232 port in the following manner:

INSTRUMENT	→	RS232
RS485 -	→	RXD
RS485 +	→	GND



This type of connection allows A SINGLE instrument to be used in a ONE WAY mode.

WIFI COMMUNICATION SETTING

OPERATION AS CLIENT connecting the instrument to an existing network

000000 [MENU/ENTER] + [0/ESC] [CALI b] ◀▶ [EtHnEt] [MENU/ENTER] [CLI Ent]

- **EnAbLE**: enables the operation of the instrument as a client in a CLIENT/SERVER or CLIENT/ACCESS POINT network.
- **APSSId**: network name (it must consist of only numbers; e.g.: 123456).
- **IPAddr**: instrument IP address.
- **SUBnEt**: instrument Subnet Mask.
- **GAteWAY**: Gateway address of Ethernet network.
- **HOSTIP**: access point IP address.
- **PASSU**: login password of the access point; if no password is required, set 0. Any password must be an 8-digit number that starts with two zeros; e.g.: 00123456 (only the underlined digits can be displayed and modified by the instrument).



In order to apply the changes, turn the instrument off, wait for 10 seconds and turn it back on.

OPERATION AS ACCESS POINT connecting other devices to the network created by the instrument

000000 [MENU/ENTER] + [0/ESC] [CALI b] ◀▶ [EtHnEt] [MENU/ENTER] [ACC. P]

- **SSId**: network name (it must consist of only numbers; e.g.: 123456).
- **IPAddr**: access point IP address.
- **PASSU**: login password of the access point; in order to leave the connection open set 000000. Any password must be an 8-digit number that starts with two zeros; e.g.: 00123456 (only the underlined digits can be displayed and modified by the instrument).



In order to apply the changes, turn the instrument off, wait for 10 seconds and turn it back on.

SELECTION OF COMMUNICATION MODE

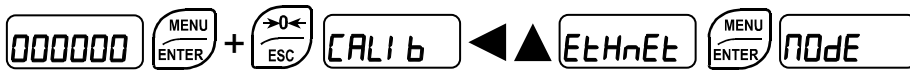

For the connection you can use both a web-socket and a virtualization software of the serial ports on ethernet.

- *nDnE*: it disables any type of communication.
- *UEbSrU*: the instrument generates a web page for remote management via web browser (see section **WEBSITE**).
- *ModBUS*: MODBUS-RTU protocol in tunneling mode; possible addresses: from 1 to 99 (see Communication protocols manual).
- *ASCII*: ASCII bidirectional protocol in tunneling mode; possible addresses: from 1 to 99 (see Communication protocols manual).
 - *ModU60*.
 - *Mod t d*.
- *Cont n*: continuous weight transmission ASCII protocol in tunneling mode (see Communication protocols manual), at the frequency set in *HEt2* item (from 10 to 300).
 - *Mod t* (set: *PARI tY* = *nDnE*, *StOP* = 1).
 - *Mod t d* (set: *PARI tY* = *nDnE*, *StOP* = 1).
- *rIP*: continuous weight transmission protocol in tunneling mode to RIP5/20/60, RIP50SHA, RIPLD series remote displays; the remote display shows the net weight or gross weight according to its settings (set: *bAUd* = 9600, *PARI tY* = *nDnE*, *StOP* = 1).
- *Hdri P*: continuous weight transmission protocol in tunneling mode to RIP6100, RIP675, RIP6125C series remote displays; the remote display shows the net weight or gross weight according to its settings (set: *bAUd* = 9600, *PARI tY* = *nDnE*, *StOP* = 1).
- *Hdri Pn*: continuous weight transmission protocol in tunneling mode to RIP6100, RIP675, RIP6125C series remote displays (set: *bAUd* = 9600, *PARI tY* = *nDnE*, *StOP* = 1); when the remote display is set to gross weight:
 - if the instrument displays the gross weight, the remote display shows the gross weight.
 - if the instrument shows the net weight, the remote display shows the net weight alternated with the message *nEt*.
- *UEI rIP*: the instrument operates as client and waits for the weight value, via RIP protocol, from a remote access point instrument connected to the same WiFi network (see section **WEIGHT READING VIA WIFI**). See this section for *ACC. P* and *CLI Ent* settings.
- *UEI Mod*: the instrument operates as client and requires the weight value, via MODBUS protocol, to a remote access point instrument connected to the same WiFi network (see section **WEIGHT READING VIA WIFI**). See this section for *ACC. P* and *CLI Ent* settings.



WARNING: both operating modes (access point and client) use communication port 10001.

EXAMPLES OF COMMUNICATION PARAMETERS SETTING

Instrument connection to an existing WiFi network (with password).

WiFi network	
SSID	123456
Access point address (HOST)	192.8.0.1
Password	00123123

Instrument configured as client		
<i>CLI Ent</i>	<i>EnAbLE</i>	YES
	<i>APSSi d</i>	123456
	<i>I PAddr</i>	192.8.0.137
	<i>SUbnEt</i>	255.255.255.0
	<i>GAtURy</i>	192.8.0.254
	<i>HOStI P</i>	—
	<i>PASSU</i>	123123
<i>ACC. P</i>	<i>SSi d</i>	—
	<i>I PAddr</i>	—
	<i>PASSU</i>	—
<i>NOdE</i>	any	

Direct connection (point-to-point) between pc/smartphone/tablet and instrument (without password).

Instrument configured as access point		
<i>CLI Ent</i>	<i>EnAbLE</i>	NO
	<i>APSSi d</i>	—
	<i>I PAddr</i>	—
	<i>SUbnEt</i>	—
	<i>GAtURy</i>	—
	<i>HOStI P</i>	—
	<i>PASSU</i>	—
<i>ACC. P</i>	<i>SSi d</i>	654321
	<i>I PAddr</i>	192.8.0.1
	<i>PASSU</i>	000000
<i>NOdE</i>	any	

Pc/smartphone/tablet configured as client	
SSID	654321
Access point address (HOST)	192.8.0.1
Password	—

Direct connection (point-to-point) in WEIRIP mode between two instruments (with password).

Instrument configured as access point		
<i>CLI Ent</i>	<i>EnAbLE</i>	NO
	<i>APSSi d</i>	—
	<i>I PAddr</i>	—
	<i>SUbnEt</i>	—
	<i>GAtURy</i>	—
	<i>HOStI P</i>	—
	<i>PASSU</i>	—
<i>ACC. P</i>	<i>SSi d</i>	654321
	<i>I PAddr</i>	192.168.0.4
	<i>PASSU</i>	112233
<i>NOdE</i>		RIP

Instrument configured as client		
<i>CLI Ent</i>	<i>EnAbLE</i>	YES
	<i>APSSi d</i>	654321
	<i>I PAddr</i>	192.168.0.1
	<i>SUbnEt</i>	—
	<i>GAtURy</i>	—
	<i>HOStI P</i>	192.168.0.4
	<i>PASSU</i>	112233
<i>ACC. P</i>	<i>SSi d</i>	—
	<i>I PAddr</i>	—
	<i>PASSU</i>	—
<i>NOdE</i>		WEIRIP

Direct connection (point-to-point) in WEIMOD mode between instrument and other Laumas devices equipped with WiFi option (without password).

Laumas device equipped with WiFi option configured as access point		
<i>CLI Ent</i>	<i>EnAbLE</i>	NO
	<i>APSSi d</i>	—
	<i>I PAddr</i>	—
	<i>SUbnEt</i>	—
	<i>GAtURy</i>	—
	<i>HOStI P</i>	—
	<i>PASSU</i>	—
<i>ACC. P</i>	<i>SSi d</i>	654321
	<i>I PAddr</i>	192.168.0.1
	<i>PASSU</i>	000000
<i>NOdE</i>		MODBUS

Instrument configured as client		
<i>CLI Ent</i>	<i>EnAbLE</i>	YES
	<i>APSSi d</i>	654321
	<i>I PAddr</i>	192.167.0.4
	<i>SUbnEt</i>	—
	<i>GAtURy</i>	—
	<i>HOStI P</i>	192.168.0.1
	<i>PASSU</i>	000000
<i>ACC. P</i>	<i>SSi d</i>	—
	<i>I PAddr</i>	—
	<i>PASSU</i>	—
<i>NOdE</i>		WEIMOD

CONNECTION TO PC BY VIRTUAL WIFI/ETHERNET PORT

A PC, by a virtual serial port, can be connected to the instrument via WiFi. To install the virtual COM port, use the CPR Manager included in the supply:

- run the file *CPR.exe* on the CD;
- add a serial port;
- set an IP address (host) and a TCP port (10001);
- save.

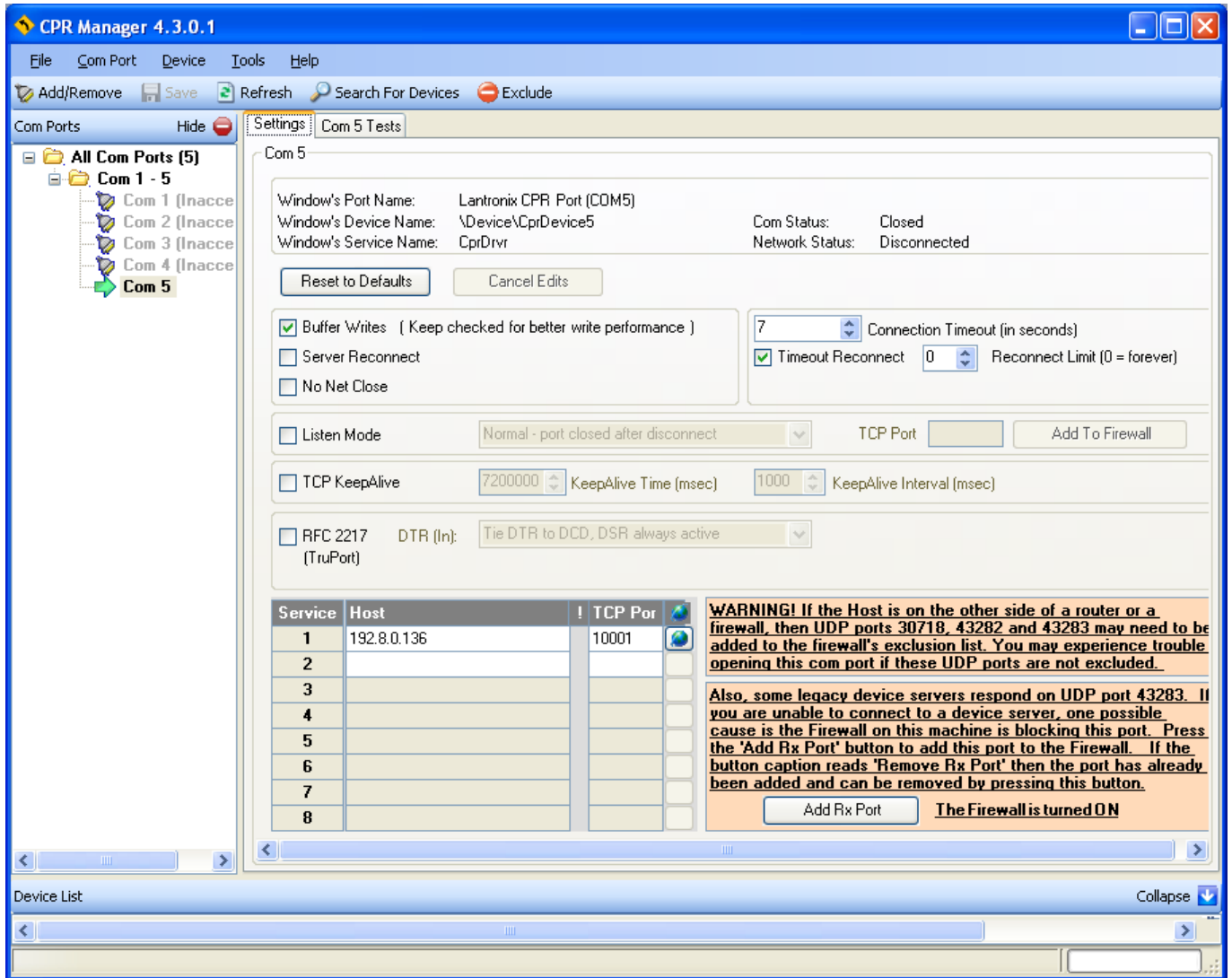

Use the just created virtual COM port to communicate with the instrument using the selected protocol (see section **WIFI COMMUNICATION SETTING**).

Alternatively connect to the instrument using a socket (e.g.: Winsock) on port 10001.

WEBSITE



WARNING: both operating modes (access point and client) use communication port 10001.

Set the *UEb5rU* communication mode (from *EEHnEt* menu of the instrument). Open your web browser and point to the instrument address to be monitored (e.g.: 192.168.0.1:10001), it will open the following page:

LAUMAS[®]
ELETTRONICA

Login

Username

Password

Login

© LAUMAS Elettronica S.r.l. - All rights reserved - Ver. 0.7 - www.laumas.com SN: 560999999

Enter the user name (if any) and the password supplied with the instrument in respective fields, then press Login to enter the status page:

LAUMAS[®]
ELETTRONICA

Status | Settings | Exit

ErCell ErAD >9 div >110% GrOver NetOver Net **Stab** ZERO

GROSS Weight 2827.4 kg

NET Weight 2827.4 kg

Inputs

Outputs

Setpoint 1	500.0	kg
Setpoint 2	1000.0	kg
Setpoint 3	3000.0	kg
Setpoint 4	1000.0	kg

Semiautomatic Tare Semiautomatic Zero GROSS Display

Keypad Lock Keypad Display Lock Keypad Display Unlock

© LAUMAS Elettronica S.r.l. - All rights reserved - Ver. 0.7 - www.laumas.com SN: 560999999

The instrument status page shows the gross and net weight read, the setpoint values set and allows you to send the main commands (Tare, Zero setting, etc.); it also shows instrument status, including possible anomalies:

- ErCell:** load cell error
- ErAD:** instrument converter error
- >9div:** weight exceeds maximum weight by 9 divisions
- >110%** weight exceeds 110% of full scale
- GrOver** gross weight over 999999
- NetOver** net weight over 999999
- Net** instrument shows the net weight
- Stab** weight is stable
- ZERO** weight is zero

Number of decimals and unit of measure are read by the instrument; if outputs are set in PLC mode, click on related icons to do a remote status check.

Click on **Settings** to enter the instrument configuration page:

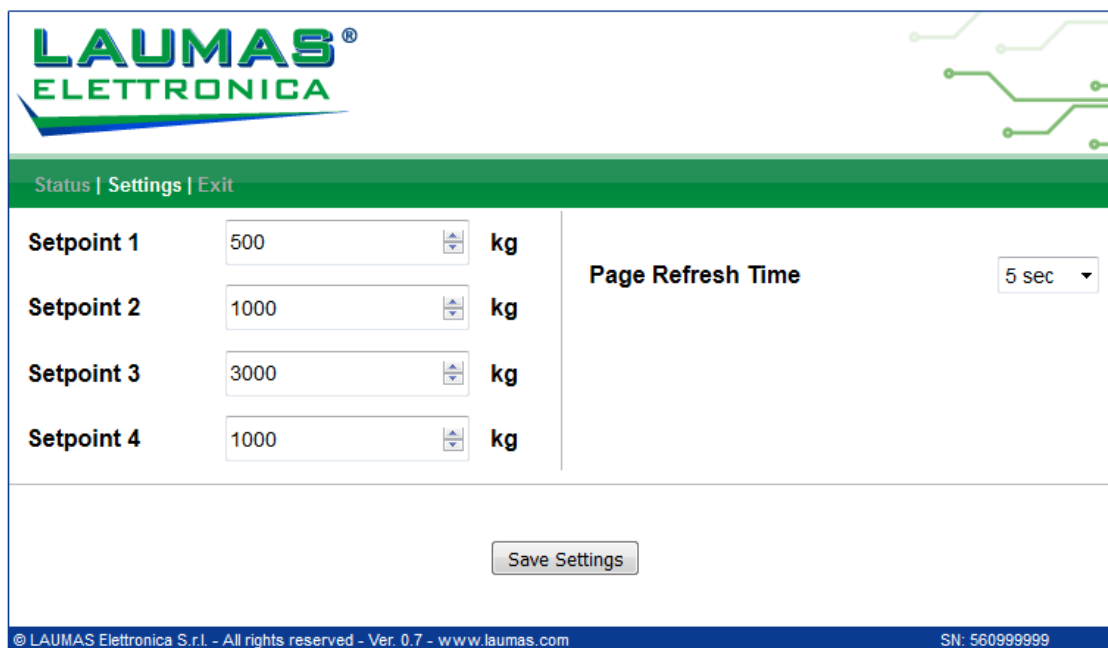

In the configuration page you can set the page refresh time and the setpoint values. By pressing **SAVE SETTINGS**, the new values are sent to the instrument and activated.

REMOTE WEIGHT READING

Overview:

By transmitting instrument, it means the one connected to the load cell.

By receiving instrument, it means the one which receives the weight via serial port or WiFi.

This function allows the instrument to read the weight by another instrument (transmitting instrument) rather than by a load cell, via the RS485, RS232 or WiFi. Outputs and serial ports continue to work as described in this manual, using as weight value the one received remotely.

The instrument supports two different modes of remote weight reading:

- *UEI PDd*

- *UEI rI P*



WARNING: in order to use the remote weight reading, the weight reading mode must be set as *SErI AL* (see section **DATA DELETION AND PROGRAM SELECTION**).



It's not possible to enable the remote weight reading on several communication devices; in case of conflict, the last device set remains active.

WEIGHT READING VIA SERIAL PORT

WEIMOD MODE

The instrument works as if it were directly connected to the load cell, therefore calibrations and zero settings can be done. The protocol used is Modbus (the receiving instrument works as master and the transmitting one as slave).

Procedure:

1. TRANSMITTING INSTRUMENT (see section **SERIAL COMMUNICATION SETTING** in the transmitting instrument manual)
 - select the desired serial port
 - set *ModBUS* protocol
 - set the serial communication parameters
 - set the desired filter value (see section **FILTER ON THE WEIGHT** in the transmitting instrument manual)
2. RECEIVING INSTRUMENT (see section **SERIAL COMMUNICATION SETTING**)
 - select the desired serial port
 - set the *WEIMOD* mode



It's not possible to enable this function on several communication devices; in case of conflict, the last device set remains active.

- set the serial communication parameters as on the transmitting instrument:
 - *BAUD*: transmission speed (2400, 4800, 9600, 19200, 38400, 115200; default: 9600)
 - *SLAVE*: transmitting instrument address (from 1 to 99; default: 1)
 - *DELAY*: delay in milliseconds which elapses before the instrument replies (from 0 to 200 ms; default: 0)
 - *PARITY*:
 - *none*: no parity (default)
 - *Even*: even parity
 - *Odd*: odd parity
 - *STOP*: stop bit (1 – 2; default: 1)



The transmitting instrument display is locked and shows the instrument model. To unlock it, disconnect the receiving instrument and follow the procedure in section **KEYPAD OR DISPLAY LOCKING** in the transmitting instrument manual.

WEIRIP MODE

The instrument receives the gross weight via serial port; calibrations and zero settings must be performed on the transmitting instrument.

Procedure:

1. TRANSMITTING INSTRUMENT (see section **SERIAL COMMUNICATION SETTING** in the transmitting instrument manual)
 - select the desired serial port
 - set *rIP* protocol
 - set the serial communication parameters
2. RECEIVING INSTRUMENT (see section **SERIAL COMMUNICATION SETTING**)
 - select the desired serial port
 - set the *UEI rIP* mode



It's not possible to enable this function on several communication devices; in case of conflict, the last device set remains active.

- set the serial communication parameters as on the transmitting instrument:
 - *bAUD*: transmission speed (2400, 4800, 9600, 19200, 38400, 115200; default: 9600)
 - *dELAY*: delay in milliseconds which elapses before the instrument replies (from 0 to 200 ms; default: 0)
 - *PARITY*:
 - *nONE*: no parity (default)
 - *EVEN*: even parity
 - *ODD*: odd parity
 - *STOP*: stop bit (1 – 2; default: 1)
- set unit of measure (*UNIT*) and number of decimals (*DECIMAL*) of the gross weight received by the transmitting instrument



The *UNIT* and *DECIMAL* menu items appear in the main menu after having set the *UEI rIP* mode.

RS485 CONNECTION

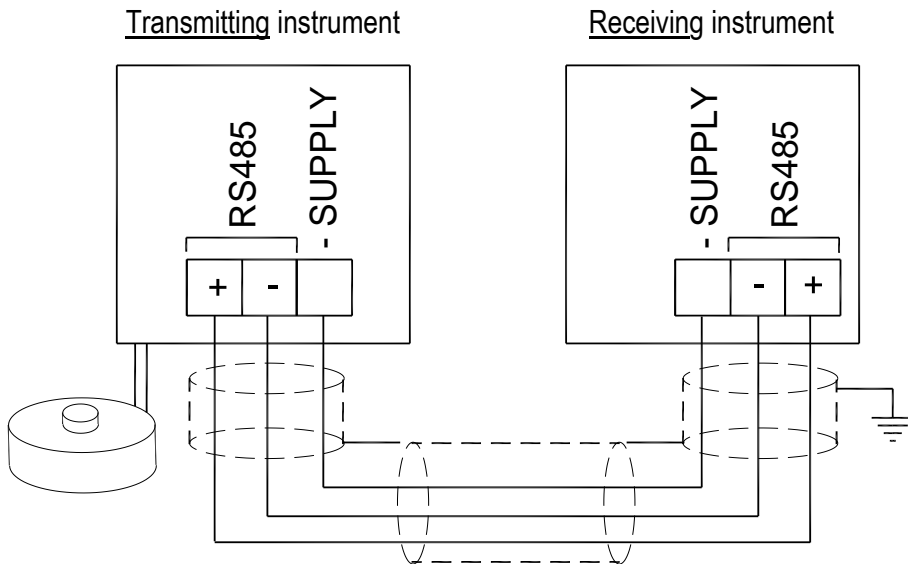

If the RS485 network exceeds 100 metres in length or baud-rate is higher than 9600, two terminating resistors are needed at the ends of the network. Two 120 ohm resistors are to be connected, between the “+” and “-” terminals of the line on terminal strip of the instrument furthest away in the network. If should be there different instruments or converters, refer to the specific manuals to determine whether it is necessary to connect the above-mentioned resistors.

RS232 CONNECTION

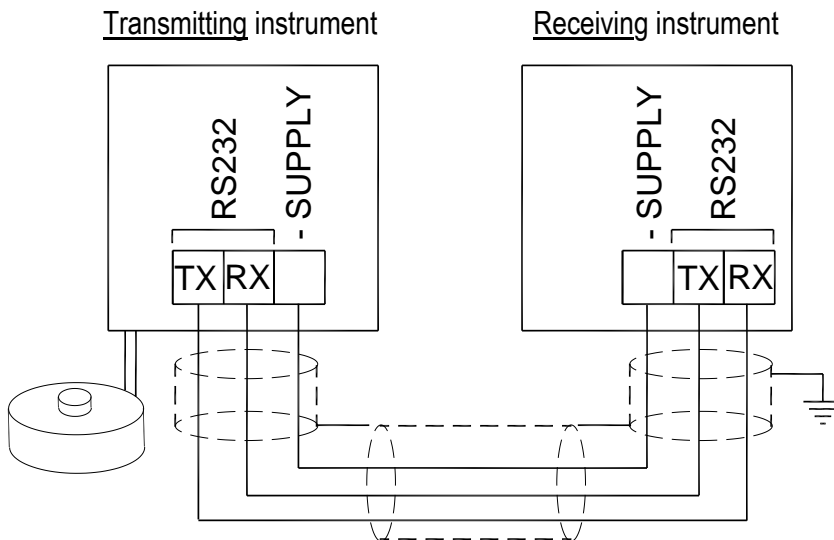

WEIGHT READING VIA WIFI

WEIMOD MODE

The instrument works as if it were directly connected to the load cell, therefore calibrations and zero settings can be done. The protocol used is Modbus (the receiving instrument works as master and the transmitting one as slave).

Procedure:

1. TRANSMITTING INSTRUMENT (see section **WIFI COMMUNICATION SETTING** in the transmitting instrument manual)
 - set the *ModBUS* communication mode
 - set the *Addr* parameter: MODBUS address of the transmitting instrument (from 1 to 99; default: 1)
 - set the instrument as *ACC. P*
 - set the WiFi communication parameters
 - set the desired filter value (see section **FILTER ON THE WEIGHT** in the transmitting instrument manual)
2. RECEIVING INSTRUMENT (see section **WIFI COMMUNICATION SETTING**)
 - set the *UEI MOD* communication mode



It's not possible to enable this function on several communication devices; in case of conflict, the last device set remains active.

- set the *SLAVE* parameter: MODBUS address of the transmitting instrument (from 1 to 99; default: 1)
- set the instrument as *CLI Ent*
- set the WiFi communication parameters as on the transmitting instrument



The transmitting instrument display is locked and shows the instrument model. To unlock it, disconnect the receiving instrument and follow the procedure in section **KEYPAD OR DISPLAY LOCKING** in the transmitting instrument manual.

WEIRIP MODE

The instrument receives the gross weight via WiFi; calibrations and zero settings must be performed on the transmitting instrument.

Procedure:

1. TRANSMITTING INSTRUMENT (see section **WIFI COMMUNICATION SETTING** in the transmitting instrument manual)
 - set the *rIP* communication mode
 - set the instrument as *ACC.P*
 - set the WiFi communication parameters
2. RECEIVING INSTRUMENT (see section **WIFI COMMUNICATION SETTING**)
 - set the *UEI rIP* communication mode

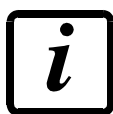

It's not possible to enable this function on several communication devices; in case of conflict, the last device set remains active.

- set the instrument as *ELI Ent*
- set the WiFi communication parameters as on the transmitting instrument
- set unit of measure (*Unit E*) and number of decimals (*dECI N*) of the gross weight received by the transmitting instrument



The *Unit E* and *dECI N* menu items appear in the main menu after having set the *UEI rIP* mode.

TEST



- Input Test:

I n: ensure that for each open input *0* is displayed, *1* is displayed when the input is closed.

- Output Test:

Out: setting *0* ensure that the corresponding output opens. Setting *1* ensure that the corresponding output closes.

- Millivolt Test:

NU-CEL: displays the load cell response signal in mV with four decimals.

ENERGY SAVING



- *nOnE*: energy saving mode disabled (default).
- *d iSP*: the display enters energy saving mode after two minutes of keypad inactivity; by pressing a key normal operations will be restored.
- **ALL (only if relays are not in use)**: the display, the WiFi module and the load cells enter energy saving mode after two minutes of keypad, serial ports or WiFi module inactivity; normal operations will be restored by pressing a key or when data are received by the serial ports. The energy saving mode is activated also if an outgoing monodirectional protocol is set. (e.g.: *Conti n* or *rl P*).

Note: the energy saving options turn off the devices involved.

INFO MENU



GENrI C: the identification data of the instrument are displayed.

- *I nStErN*: instrument model
- *SU COd*: software code
- *PrOGrN*: program type
- *FU UEr*: software version
- *SER nu*: serial number

OP2: active options are displayed.

SETPOINT PROGRAMMING

From the weight display, press **MENU** to access the setpoint setting.

MENU/ENTER: to enter a menu/confirm the data entry.

▲: to modify the displayed figure or menu item.

◀: to select a new figure or modify the displayed menu item.

ESC: to cancel and return to the previous menu.

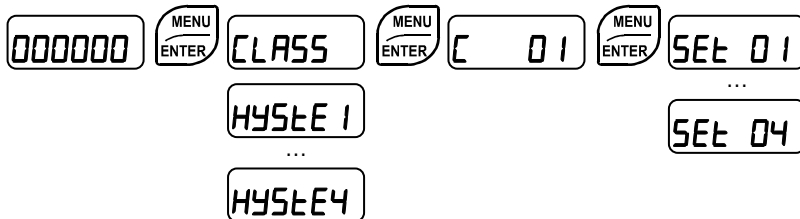

- **CLASS**: only the first class is available.
- **SEt** (from 0 to full scale; default: 0): setpoint; relay switching occurs when the weight exceed the value set in this parameter. The type of switching is settable (see section **OUTPUTS AND INPUTS CONFIGURATION**).
- **HYSLE** (from 0 to full scale; default: 0): hysteresis, value to be subtracted from the setpoint to obtain contact switching for decreasing weight. For example with a setpoint at 100 and hysteresis at 10, the switching occurs at 90 for decreasing weight.



These values are set to zero if the calibration is changed significantly (see sections **THEORETICAL CALIBRATION** and **REAL CALIBRATION (WITH SAMPLE WEIGHTS)**).

USE WITH W SERIES INSTRUMENTS



WARNING: the weight indicator must be properly configured before operating in combination with the weight transmitter (see section **DATA DELETION AND PROGRAM SELECTION** in *W* series instrument manual) and the approval status set on both instruments must be the same.

When the TLKWF is used in combination with a *W* series instrument, the load cells are connected to the weight transmitter, which transmits the weight to the indicator; all the operations of calibration and zeroing can be performed remotely through the indicator.

CONNECTION TO THE WEIGHT INDICATOR



It's not possible to enable this function on several communication devices; in case of conflict, the last device set remains active.

CONNECTION VIA RS485 PORT.

SIGNAL	TLKWF	Weight indicator
RS485 +	7	RS485 +
RS485 -	6	RS485 -
SHIELD	5	SHIELD

Weight indicator configuration

Configure, on the serial port used, the *RTS/CTS* protocol with the following parameters:

bAUD = 9600 *PARITY* = NONE *STOP* = 1

TLKWF weight transmitter configuration

Configure, on the serial port used, the MODBUS protocol with the following parameters:

bAUD = 9600 *PARITY* = NONE *STOP* = 1

CONNECTION VIA WIFI

Weight indicator configuration

Configure on WiFi communication the *RTS/CTS* protocol.

TLKWF weight transmitter configuration

Configure on WiFi communication the MODBUS protocol (see section **WIFI COMMUNICATION SETTING**).

ADDITIONAL MENU MAP



WARNING: the map shows only the additional menu items that are enabled on the W series instruments connected to the TLKWF.

Into menus changes are applied right after pressing the **ENTER** key (no further confirmation is required).

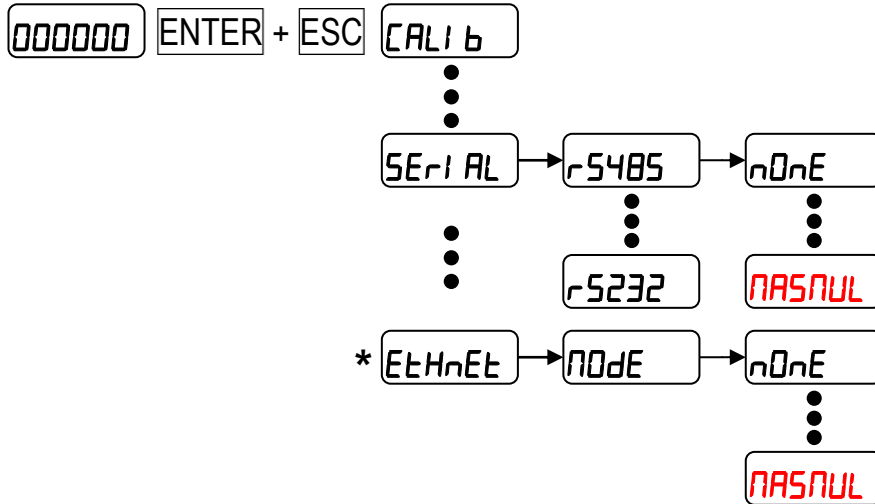

* Available only for devices with OPZW1RADIO option.

TLKWF REMOTE CONTROL

The following functions of TLKWF can be performed remotely through the weight indicator:

- INSTRUMENT COMMISSIONING
- TARE WEIGHT ZERO SETTING
- FILTER ON THE WEIGHT
- ANTI-PEAK
- TEST



WARNING: when using the weight indicator to manage the instrument, the weight indicator display replicates exactly what would be displayed on the TLKWF display.

If the configuration is performed on the TLKWF, the W series instrument connected must be restarted to allow synchronization.

REMOTE KEYPAD LOCKING

000000 ENTER + ESC CALI b ◀ ▲ n0HEyb

YES: keypad locked.

n0: keypad unlocked.

ADDITIONAL ALARMS



WARNING: the list shows only the additional alarms that are enabled on the W series instruments connected to the TLKWF.

Er CON: TLKWF is not responding, check connections and serial ports settings.

Er rES: TLKWF responds incorrectly, check serial ports settings.

ErURt: TLKWF is not responding, check connections and serial ports settings.

SYnC: the instrument is synchronizing with TLKWF, wait for the end of the operation.

ALARMS

- ErCEL:** the load cell is not connected or is incorrectly connected; the load cell signal exceeds 39 mV; the conversion electronics (AD converter) is malfunctioning; the load cell is a 4-wire and there are no jumpers between EX- and REF- and between EX+ and REF+.
- nD COP:** communication problems between transmitter and receiver; check electrical connections and instruments configuration.
- Er DL:** the weight display exceeds 110% of the full scale.
- EErDL:** weight display on transmitting instrument exceeds 110% of full scale.
- Er Ad:** internal instrument converter failure; check load cell connections, if necessary contact technical assistance.
- :** the weight exceeds the maximum capacity by 9 divisions.
- Er DF:** maximum displayable value exceeded (value higher than 999999 or lower than -999999).
- EErDF:** maximum displayable value exceeded on transmitting instrument (value higher than 999999 or lower than -999999).
- t-----:** weight too high: zero setting not possible.
- PAH-PU:** this message appears in the sample weight setting, in real calibration, after the fifth sample weight value has been entered.
- Error:** the value set for the parameter is beyond the permitted values; press **ESC** to quit the setting mode leaving the previous value unchanged. Examples: a number of decimals is selected for full scale which exceeds the instrument's display potential; value above the maximum setting value; the weight value set in sample weight verification does not match the detected mV increase.
- bLOC:** lock active on menu item, keypad or display.
- nDd SP:** It's not possible to display properly the number because is greater than 999999 or less than -999999.
- I n2Er0:** gross weight equal to zero: the semi-automatic tare operation cannot be performed.

Serial protocol alarms:

	<i>ErCEL</i>	<i>Er DL</i>	<i>Er Ad</i>	-----	<i>Er DF</i>	t-----
MODE						
Bit LSB	76543210	76543210	76543210	76543210	76543210	The response to the zero command is a 'value not valid' error (error code 3)
Status Register MODBUS RTU	xxxxxxx1	xxxx1xxx	xxxxxxx1x	xxxxx1xx	On gross: xxx1xxxx On net: xx1xxxxx	
ASCII	O-F	O-L	O-F	O-L	O-F	&aa#CR
RIP *	O-F	O-L	O-F	O-L	O-F	O-F
HDRIP-N	ERCEL	ER OL	ER AD	#####	ER OF	O SET
CONTIN	ERCEL	ER OL	ER AD	^^^^^^	ER OF	O SET

* For RIP remote displays, if the message exceeds 5 digits the display reads -----.

In case of alarm, the relays open.

ALARMS AND MESSAGES CONCERNING THE WIFI MODULE

The bottom line of the instrument display shows the WiFi module status:

- H: the WiFi module is faulty.
- P: the WiFi module is OK:
 - If configured as client, it's not connected to any network.
 - If configured as access point, it's correctly set up.
- L: the WiFi module is working and it's properly connected to an access point or a generic WiFi network.
- UPDATE**: the instrument is storing and checking the entered settings; wait until the message has disappeared to proceed.
- Error**: during the settings storage and check some error occurred; verify and enter the last settings again.

OPTIONS

OPZBATTWF: INTERNAL BATTERY

- Battery pack made up of eight 1.2 V NiMH rechargeable elements, type AA, 2450 mAh capacity, supplied already installed in the instrument, with dedicated external switch (overall size: 190x80x65 mm).
- To achieve maximum battery efficiency, run three full charge/discharge cycles on new batteries and keep working temperature within 45°C.
- The battery is automatically recharged every time the instrument is powered by an external 24 VDC power source; a full charge takes about 20 hours.
- The instrument is battery powered only when not mains powered.
- Battery power supply may be disabled through the dedicated switch.
- The bottom line of the instrument display shows the battery status:
 - -[- : charging in progress.
 - --- : charging finished.
 - F-- : charging problems, replace the battery pack.
- Use the functions of the **ENERGY** menu to optimize battery lifetime (see section **ENERGY SAVING**).

Mode	Maximum operating time (hours)
4 load cells (350 ohm), energy saving: ALL	24
4 load cells (350 ohm), energy saving: di SP	11
4 load cells (350 ohm), energy saving: nOnE	10

Approx. maximum operating time for typical use with fully charged battery.

BATEXT: EXTERNAL BATTERY

- 12 V rechargeable lead battery, 2800 mAh capacity, supplied in IP67 box (dimensions: 160x80x85 mm).
- The battery is automatically recharged every time the instrument is powered by an external 24 VDC power source; a full charge takes about 8 hours.
- The instrument is battery powered only when not mains powered.
- Two LEDs inside the IP67 box show the battery status:
 - green LED lit: charging in progress.
 - red LED lit: charging problems, replace the battery pack.
- Use the functions of the *EnErGy* menu to optimize battery lifetime (see section **ENERGY SAVING**).

Mode	Maximum operating time (hours)
4 load cells (350 ohm), energy saving: <i>ALL</i>	26
4 load cells (350 ohm), energy saving: <i>dI SP</i>	13
4 load cells (350 ohm), energy saving: <i>nOnE</i>	12

Approx. maximum operating time for typical use with fully charged battery.

CONNECTING THE BATTERY TO THE INSTRUMENT

Attach the connector on the left to the instrument and the connector on the right to the power supply. Two flying connectors are supplied for the connections, which must be wired as follow (outer diameter of the cable: 6÷10 mm):

Male connector	Instrument
1	GND
2	+SUPPLY







Female connector	Power supply
1	GND
2	24 VDC





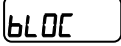

RESERVED FOR THE INSTALLER

MENU LOCKING



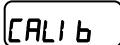

Through this procedure, it's possible to block the access to any menu on the instrument. Select the menu that you wish to lock:

   press  and  simultaneously for 3 seconds, the display shows  (the left point on the text indicates that this menu item is now locked). If the operator tries to enter this menu, the access is denied and the display shows .

MENU UNLOCKING

   press  and  simultaneously for 3 seconds, the unlock password is requested (if enabled) and the display shows  (the left point on the text is off to indicate that this menu item is unlocked).

TEMPORARY MENU UNLOCKING

   press  and  simultaneously for 3 seconds, the unlock password is requested (if enabled): it is now possible to enter and modify all menus including those which are locked. By returning to weight display, the menu lock is restored.

SETTING UNLOCK PASSWORD

  +     



The password must contain 6 characters; in order to change a customized password, the current password is required.

By setting  (default) the unlock password is disabled.



DATA DELETION AND PROGRAM SELECTION



WARNING: operations must only be performed after contacting technical assistance.

After each operation the display shows , press  to continue.

By pressing  the procedure is cancelled and no changes are made.

Upon instrument power-on hold down the  key until the display shows , then proceed as follows:

CONSTANTS RESTORE (does not erase the calibration): confirm **P-DC**, use arrow keys to select **PA55U**, set code 6935 and confirm.

PROGRAM SELECTION: confirm **P-DC** and use the arrow keys to select the desired program:

bASE: basic program, setpoint management only.

r iP: weight remote display program with setpoint.

- Set the weight reading mode (except for **r iP** program):
 - **CELL**: the weight is received by load cells.
 - **SERIAL**: the weight is received remotely (**WEIMOD** or **WEIRIP** mode).
 - Set the approval status (only if one of the following has not been set: **r iP**, **SERIAL**)
 - **NOLEG**: not approved program;
 - **LEGAL**: approved program, single interval*;
 - **LEGN**: approved program, multi-interval*;
 - **LEGNr**: approved program, multiple range*;
- * Contact technical assistance to request the proper manual and the correct procedures for approval, indicating mandatory hardware code and serial number (see section **INSTRUMENT COMMISSIONING**).

By confirming, the instrument is restored to default and data is erased.



If you do not have a specific manual for the newly set program, you can request it to technical assistance.

KEYPAD OR DISPLAY LOCKING

Press **ESC** immediately followed by **▲** hold them down for about 5 seconds (this operation is also possible via the MODBUS and ASCII protocols):

- **FREE**: no lock.
- **HEY**: keypad lock: if active, when a key is pressed the message **BLDC** is displayed for 3 seconds.
- **dI 5P**: keypad and display lock: if active, the keypad is locked and the display shows the instrument model (weight is not displayed); by pressing a key the display shows **BLDC** for 3 seconds.

DECLARATION OF CONFORMITY - EU

LAUMAS

Innovation in Weighing

SISTEMI DI PESATURA INDUSTRIALE - CELLE DI CARICO - BILANCE

LAUMAS Elettronica S.r.l.
Via I Maggio 6 - 43022 Montechiarugolo (PR) Italy
C.F. - P.IVA IT01661140341

Tel. (+39) 0521 683124
Fax (+39) 0521 681091

Email: laumas@laumas.it
Web: <http://www.laumas.com>

Fabbricante metrico Prot. N. 7340 Parma - R.E.A. PR N. 169833 - Reg. Imprese PR N.19393 - Registro Nazionale Pile
N. IT09060P00000982 - Registro A.E.E. N. IT0802000002494 - N. Mecc. PR 008385 - Cap. Sociale € 100.000 int. vers.

SISTEMA QUALITÀ CERTIFICATO UNI EN ISO 9001 - SISTEMA GESTIONE AMBIENTALE ISO 14001 - MODULO D: GARANZIA DELLA QUALITÀ DEL PROCESSO DI PRODUZIONE

I	Dichiarazione di conformità	Dichiariamo che il prodotto al quale la presente dichiarazione si riferisce è conforme alle norme di seguito citate.
GB	Declaration of conformity	We hereby declare that the product to which this declaration refers conforms with the following standards.
E	Declaración de conformidad	Manifestamos en la presente que el producto al que se refiere esta declaración está de acuerdo con las siguientes normas
D	Konformitäts-erklärung	Wir erklären hiermit, dass das Produkt, auf das sich diese Erklärung bezieht, mit den nachstehenden Normen übereinstimmt.
F	Déclaration de conformité	Nous déclarons avec cela responsabilité que le produit, auquel se rapporte la présente déclaration, est conforme aux normes citées ci-après.
CZ	Prohlášení o shode	Tímto prohlašujeme, že výrobek, kterého se toto prohlášení týká, je v souladu s níže uvedenými normami.
NL	Conformiteit-verklaring	Wij verklaren hiermede dat het product, waarop deze verklaring betrekking heeft, met de hierna vermelde normen overeenstemt.
P	Declaração de conformidade	Declaramos por meio da presente que o produto no qual se refere esta declaração, corresponde às normas seguintes.
PL	Deklaracja zgodności	Niniejszym oświadczamy, że produkt, którego niniejsze oświadczenie dotyczy, jest zgodny z poniższymi normami.
RUS	Заявление о соответствии	Мы заявляем, что продукт, к которому относится данная декларация, соответствует перечисленным ниже нормам.

Models: TLKWF

Mark Applied	EU Directive	Standards
CE	2014/35/EU Low Voltage Directive	<i>Not Applicable (N/A)</i> for VDC type EN 61010-1:2010+A1:2019 for 230/115 VAC type
CE	2014/30/EU EMC Directive	EN 55011:2016+A1+A11:2020 EN 61000-6-2:2019 EN 61000-6-4:2019 EN 61000-4-2:2009 EN 61000-4-3:2006+A2:2010 EN 61000-4-4:2012 EN 61000-4-5:2014+A1:2017 EN 61000-4-6:2014
CEM (only if "M" mark is applied)	2014/31/EU NAWI Directive	EN 45501:2015 OIML R76-1:2006
CE	2014/53/EU RED Directive	EN 300 328 V2.1.1 EN 301 489-1 V2.1.1 EN 301 489-17 V3.1.1 EN 62311:2008 EN60950-1:2006+A1:2010+A12:2011+A2:2013

Montechiarugolo (PR), 16/11/2022

LAUMAS Elettronica s.r.l.
M. Consonni
(Legal Representative)

M. Consonni

DECLARATION OF CONFORMITY - UKCA

LAUMAS

Innovation in Weighing

SISTEMI DI PESATURA INDUSTRIALE - CELLE DI CARICO - BILANCE

LAUMAS Elettronica S.r.l.
Via I Maggio 6 - 43022 Montechiarugolo (PR) Italy
C.F. - P.IVA IT01661140341

Tel. (+39) 0521 683124
Fax (+39) 0521 681091

Email: laumas@laumas.it
Web: <http://www.laumas.com>

Fabbricante metrico Prot. N. 7340 Parma - R.E.A. PR N. 169833 - Reg. Imprese PR N.19393 - Registro Nazionale Pile N. IT09060P00000982 - Registro A.E.E. N. IT0802000002494 - N. Mecc. PR 008385 - Cap. Sociale € 100.000 int. vers.

SISTEMA QUALITÀ CERTIFICATO UNI EN ISO 9001 - SISTEMA GESTIONE AMBIENTALE ISO 14001 - MODULO D: GARANZIA DELLA QUALITÀ DEL PROCESSO DI PRODUZIONE

I	Dichiarazione di conformità	Dichiariamo che il prodotto al quale la presente dichiarazione si riferisce è conforme alle norme di seguito citate.
GB	Declaration of conformity	We hereby declare that the product to which this declaration refers conforms with the following standards.
E	Declaración de conformidad	Manifestamos en la presente que el producto al que se refiere esta declaración está de acuerdo con las siguientes normas
D	Konformitäts-erklärung	Wir erklären hiermit, dass das Produkt, auf das sich diese Erklärung bezieht, mit den nachstehenden Normen übereinstimmt.
F	Déclaration de conformité	Nous déclarons avec cela responsabilité que le produit, auquel se rapporte la présente déclaration, est conforme aux normes citées ci-après.
CZ	Prohlášení o shode	Tímto prohlašujeme, že výrobek, kterého se toto prohlášení týká, je v souladu s níže uvedenými normami.
NL	Conformiteit-verklaring	Wij verklaren hiermede dat het product, waarop deze verklaring betrekking heeft, met de hierna vermelde normen overeenstemt.
P	Declaração de conformidade	Declaramos por meio da presente que o produto no qual se refere esta declaração, corresponde às normas seguintes.
PL	Deklaracja zgodności	Niniejszym oświadczamy, że produkt, którego niniejsze oświadczenie dotyczy, jest zgodny z poniższymi normami.
RUS	Заявление о соответствии	Мы заявляем, что продукт, к которому относится данная декларация, соответствует перечисленным ниже нормам.

Models: TLKWF

Mark Applied	UK legislation	Standards
UK CA	Electrical Equipment (Safety) Regulations 2016	<i>Not Applicable (N/A)</i> for VDC type BS EN 61010-1:2010+A1:2019 for 230/115 VAC type
UK CA	Electromagnetic Compatibility Regulations 2016	BS EN 55011:2016+A1+A11:2020 BS EN 61000-6-2:2019 BS EN 61000-6-4:2019 BS EN 61000-4-2:2009 BS EN 61000-4-3:2006+A2:2010 BS EN 61000-4-4:2012 BS EN 61000-4-5:2014+A1:2017 BS EN 61000-4-6:2014
UK CA M (only if "M" mark is applied)	Non-automatic Weighing Instruments Regulations 2016	BS EN 45501:2015
UK CA	Radio Equipment Regulations 2017	ETSI EN 300 328 V2.1.1 ETSI EN 301 489-1 V2.1.1 ETSI EN 301 489-17 V3.1.1 BS 62311:2008 BS 60950-1:2006+A1:2010+A12:2011+A2:2003

Montechiarugolo (PR), 16/11/2022

LAUMAS Elettronica s.r.l.
M. Consonni
(Legal Representative)

M. Consonni

On our website www.laumas.com there are videos on the guidelines for correct installation of weighing systems and video tutorials on configuring our transmitters and weight indicators.

All Laumas product manuals are available online. You can download the manuals in PDF format from www.laumas.com by consulting the Products section or the Download Area. Registration is required.

Think about the environment before you print!

CERTIFICATION OF THE ENVIRONMENTAL MANAGEMENT SYSTEM
in accordance with UNI EN ISO 14001.

Laumas contributes to environmental protection by saving on paper consumption.