

VARI-CART

500 SERIES

VARI-CART

SINGLE WIDTH / 500 SERIES



It's all in the name....Vari-Cart.

A varied-use, staple cart for every hospital ward. From its simple construction through to its durable finish, our 500 Series single width Vari-Cart range with upgradeable security options, is fit for purpose in even the most challenging working environments.

Tool-less parts and maintenance further extend the product life without expensive bills for replacement carts. The choice from 8 frame colours, together with tray choice and combination, come as standard on all models.

[Explore our 500 series Vari-Cart range >](#)

FW3100
OPEN

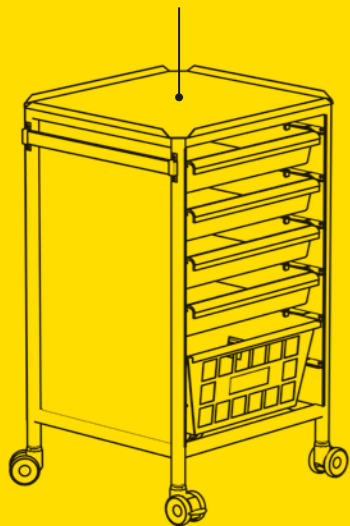

FW3100ECD
**ENCLOSED
CLEAR DOOR**

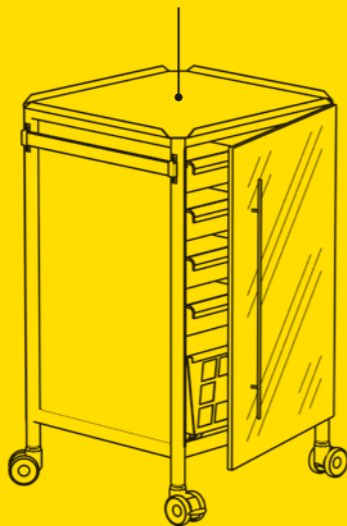

FW3100EWD
**ENCLOSED
TRESPA® DOOR**

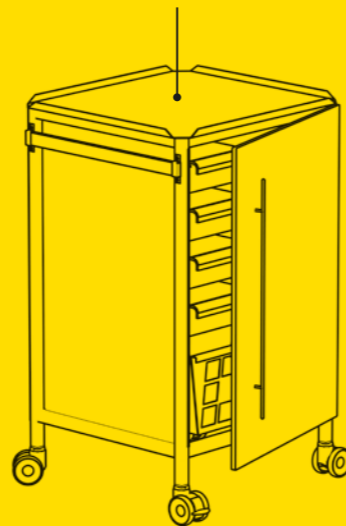

○ **What is included on the base models?**

The base model for any of our 500 Series Vari-Cart products includes the option to choose the cart height, the colour of your cart and your combination of storage trays at no extra cost!

If you would like to upgrade components or add optional extras, there are plenty to choose from so you can easily create the cart that suits your needs.

**1. CHOOSE YOUR
IDEAL HEIGHT
(8 available)**

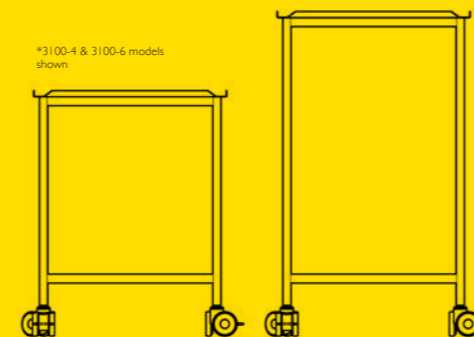

**2. CHOOSE YOUR
FRAME COLOUR
(8 available)**



**3. CHOOSE YOUR
STORAGE TRAYS
(in any combination)**

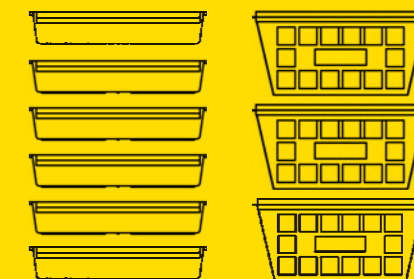

4. CHOOSE YOUR HOOK-OVER ACCESSORIES* (optional, see pages 22-25)

*3100-6 model shown throughout

WHY BUY FREEWAY? BECAUSE ALL OF THESE FEATURES ARE STANDARD!



Frame Colour Choice

Every Vari-Cart in the range can be painted in one of 8 colours available, to help you brighten wards and organise and code by colour.



Ultra heavy-duty castors

Featuring a triple ball-race bearing set, our castors and rubberised tyres are built to last and ensure effortless manoeuvring of a fully stocked cart.



Super-Tough Nylon Paint

All components used, large or small, are resistant to everyday knocks and scrapes with an extremely durable and easy-clean nylon powder coat paint finish.



Any Tray Configuration

Choose your configuration of trays with a unique option to mix acrylic open trays and metal open baskets, based on your requirements.



Rear Security Panel

The rear security panel, on all enclosed Vari-Cart models, provides protection to the rear of the cart from theft or loss of stock or consumables.



Fully Assembled

The Vari-Cart range comes to you fully assembled and ready to roll into use. Simply unpack from the box and your cart can be put into action.

It's simple: choose the height that is the best fit for your requirements!

The vast choice of frame heights gives endless tray configurations and the ability to maximise the storage capacity within any given space.

SELECTING THE RIGHT HEIGHT...

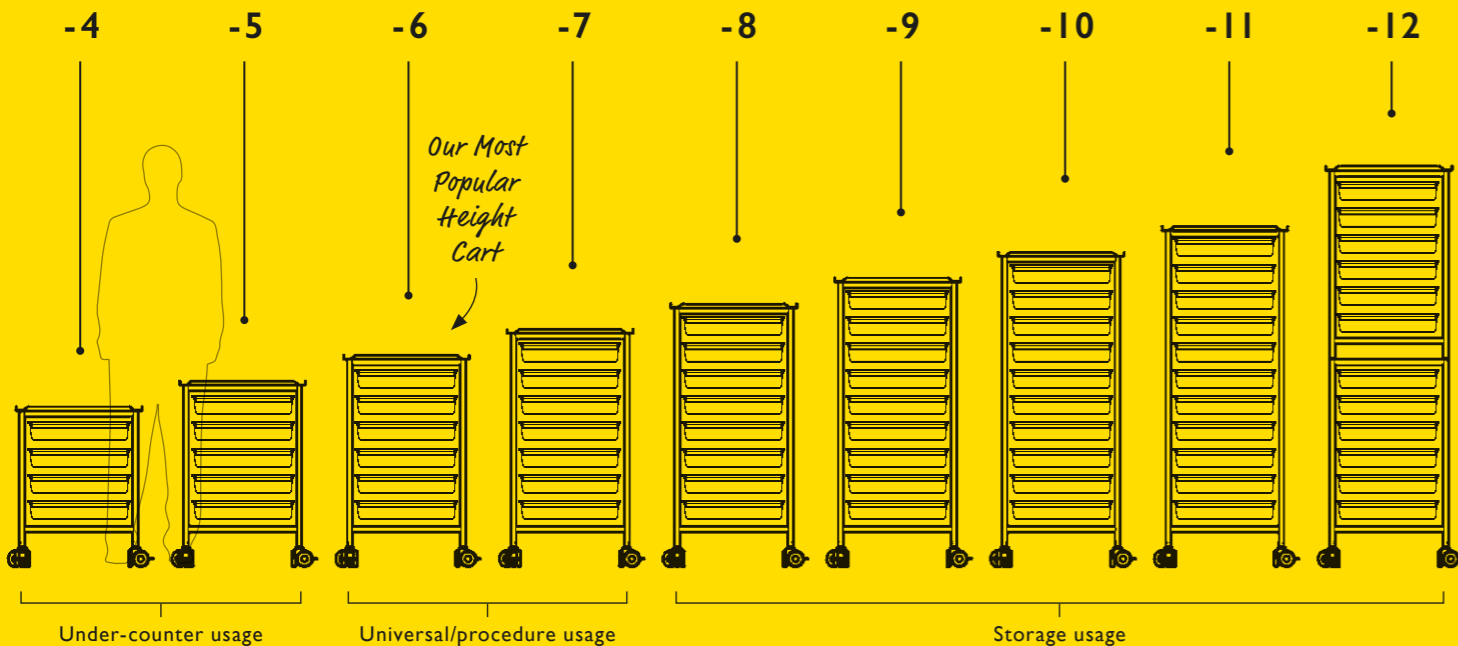

VARI-CART 500 SERIES MODEL FINDER

OPEN

PRODUCT CODE	HEIGHT (MM)	PAGE
FW3100-4	710	46
FW3100-5	815	47
FW3100-6	920	48
FW3100-7	1025	49
FW3100-8	1130	50
FW3100-9	1235	51
FW3100-10	1340	52
FW3100-11	1445	53
FW5040-12	1725	54
FW5080-12	1725	55

ENCLOSED CLEAR DOOR

PRODUCT CODE	HEIGHT (MM)	PAGE
FW3100 ECD-4	710	58
FW3100 ECD-5	815	60
FW3100 ECD-6	920	62
FW3100 ECD-7	1025	64
FW3100 ECD-8	1130	66
FW3100 ECD-9	1235	68
FW3100 ECD-10	1340	70
FW3100 ECD-11	1445	72
FW5050 ECD-12	1725	74
FW5090 ECD-12	1725	76

ENCLOSED TRESPA® DOOR

PRODUCT CODE	HEIGHT (MM)	PAGE
FW3100 EWD-4	710	59
FW3100 EWD-5	815	61
FW3100 EWD-6	920	63
FW3100 EWD-7	1025	65
FW3100 EWD-8	1130	67
FW3100 EWD-9	1235	69
FW3100 EWD-10	1340	71
FW3100 EWD-11	1445	73
FW5060 EWD-12	1725	75
FW5100 EWD-12	1725	77



500 SERIES **VARI-CART** OPEN

- Open front and back
- 2 medical rails
- 8 frame colours available
- Any tray combination
- 4 ultra-durable castors/2 brakes
- Upgradeable worktop

- Simple modular construction - the Vari-Cart's greatest asset.



The Vari-Cart Open has been designed to make your life simple. Whether routine deep-cleaning or replacing a damaged part, the Vari-Cart's construction makes it simple. To disassemble the cart, just remove 4 thumbscrews – no tools, no hassle.



VARI-CART OPEN - 500 SERIES / 4 TRAY SPACE



PRODUCT CODE
FW3100-4 Open Vari-Cart 500 Series

Our standard Open Vari-Cart with 4 tray spaces, whilst the smallest in the range, does not lack space. It provides the perfect solution for storage and transport whilst still slotting under counters to ensure it does not get in the way, even in the tightest of spaces on a ward. The user will not be disappointed with the flexibility and manoeuvrability of our Vari-Cart open with 4 tray spaces.

DIMENSIONS
Height = 710mm Width = 540mm Depth = 540mm

PRODUCT ELEVATIONS

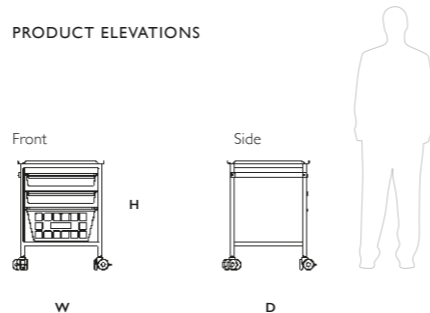

FRAME/WORKTOP COLOURS *(included in price)*

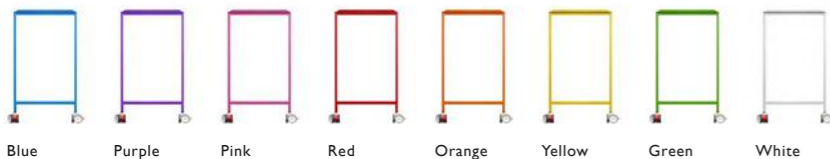

Blue Purple Pink Red Orange Yellow Green White

STORAGE TRAY CHOICE *(included in price)*

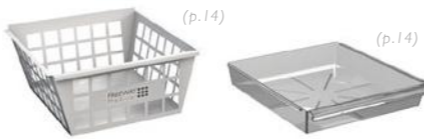

Double-space metal basket Single-space acrylic tray

VARI-CART OPEN - 500 SERIES / 5 TRAY SPACE

PRODUCT CODE
FW3100-5 Open Vari-Cart 500 Series

A 5 tray capacity on this Open Vari-Cart offers useful storage and can be customised too. Try adding a splash of colour for your frame to make it really look the part. This model, alongside the rest of our range, is available in a selection of 8 durable and easy-to-clean colours at no extra cost.

DIMENSIONS
Height = 815mm Width = 540mm Depth = 540mm

PRODUCT ELEVATIONS

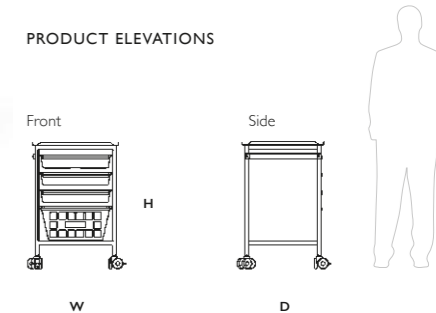

WORKTOP UPGRADES

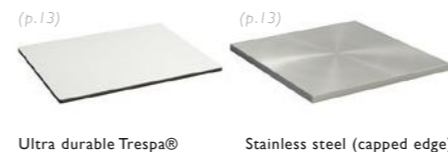

Ultra durable Trespa® Stainless steel (capped edge)

HOOK-OVER ACCESSORIES *(optional)*



(p.22)
*Consumables not included.

STORAGE COMBINATIONS *(included in price)*



VARI-CART OPEN - 500 SERIES / 6 TRAY SPACE



PRODUCT CODE
FW3100-6 Open Vari-Cart 500 Series

The 6 tray space Open Vari-Cart is the most popular height cart and is perfect for universal or procedure usage, offering space and convenience for both storage and transportation of medicine and equipment. Speak to one of our team today to find out what height model would be most suited to you and your needs – we are here to understand your requirements.

DIMENSIONS
Height = 920mm Width = 540mm Depth = 540mm

PRODUCT ELEVATIONS

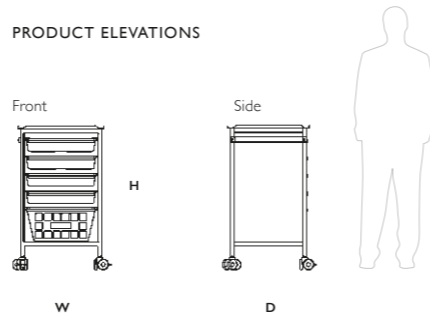

FRAME/WORKTOP COLOURS (included in price)



Blue Purple Pink Red Orange Yellow Green White

STORAGE TRAY CHOICE (included in price)

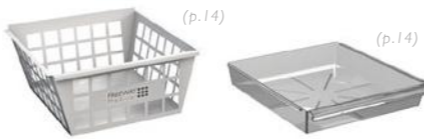

Double-space metal basket Single-space acrylic tray

VARI-CART OPEN - 500 SERIES / 7 TRAY SPACE



PRODUCT CODE
FW3100-7 Open Vari-Cart 500 Series

The Open Vari-Cart range is undeniably premium for design, durability and manoeuvrability. Our ultra heavy-duty castors are built to last and ensure effortless movement of even the most fully stocked cart.

DIMENSIONS
Height = 1025mm Width = 540mm Depth = 540mm

PRODUCT ELEVATIONS

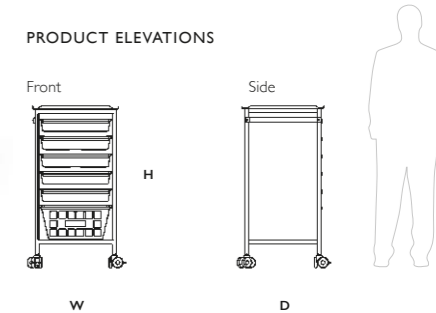

WORKTOP UPGRADES

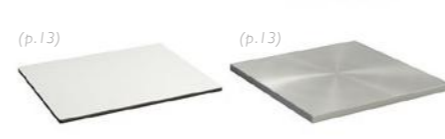

Ultra durable Trespa® Stainless steel (capped edge)

HOOK-OVER ACCESSORIES (optional)



*Consumables not included.

STORAGE COMBINATIONS (included in price)



VARI-CART OPEN - 500 SERIES / 8 TRAY SPACE



FRAME/WORKTOP COLOURS (included in price)

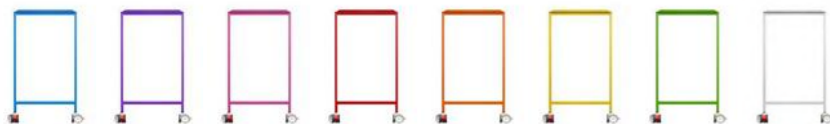

Blue Purple Pink Red Orange Yellow Green White

PRODUCT CODE
FW3100-8 Open Vari-Cart 500 Series

An 8 tray space capacity on this Open Vari-Cart is convenient, easy to manoeuvre and effective for a variety of uses for medicine and equipment. With double the capacity of our smallest option, 8 tray spaces offers its user ample room and reliability for use in, across and throughout hospitals. Find the Vari-Cart that suits your needs from across our range and see how it can do the work for you.

DIMENSIONS
Height = 1130mm Width = 540mm Depth = 540mm

PRODUCT ELEVATIONS

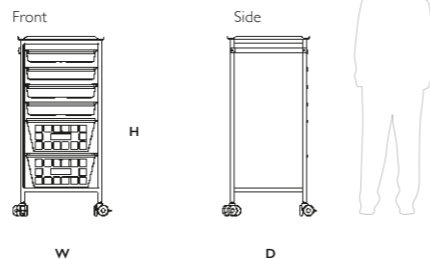

STORAGE TRAY CHOICE (included in price)

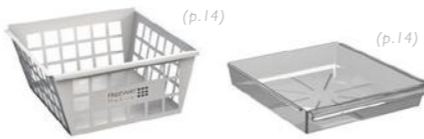

Double-space metal basket Single-space acrylic tray

VARI-CART OPEN - 500 SERIES / 9 TRAY SPACE



WORKTOP UPGRADES

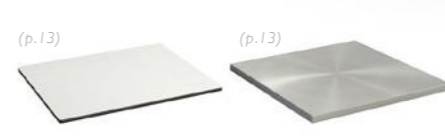

Ultra durable Trespa® Stainless steel (capped edge)

PRODUCT CODE
FW3100-9 Open Vari-Cart 500 Series

With copious amounts of storage, and endless possible personalisation, what could be better about this Open Vari-Cart? How about if we told you that every model in the Freeway Medical range comes fully assembled and ready to use once unpacked!

DIMENSIONS
Height = 1235mm Width = 540mm Depth = 540mm

PRODUCT ELEVATIONS

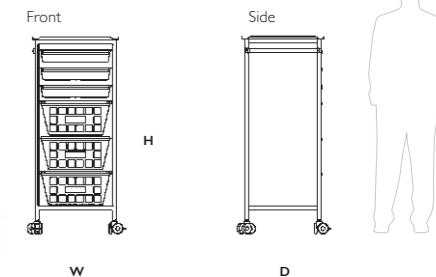

STORAGE COMBINATIONS (included in price)



HOOK-OVER ACCESSORIES (optional)



*Consumables not included.

VARI-CART OPEN - 500 SERIES / 10 TRAY SPACE



PRODUCT CODE
FW3100-10 Open Vari-Cart 500 Series

Our first double digit Open Vari-Cart has 10 tray spaces for you to utilise from both the front and the back of the cart. The Vari-Carts are designed with you in mind, making the 10 tray space model, alongside every other, ideal for fitting in to your working environment just how you require.

DIMENSIONS
Height = 1340mm Width = 540mm Depth = 540mm

PRODUCT ELEVATIONS

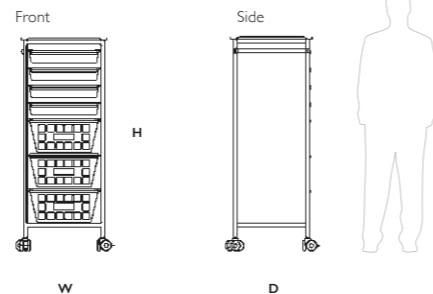

FRAME/WORKTOP COLOURS *(included in price)*

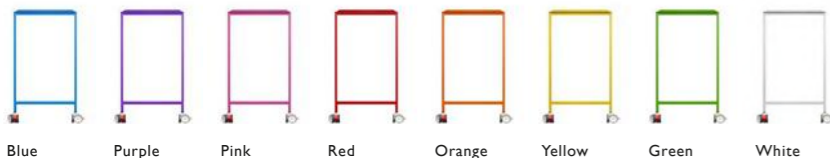

Blue Purple Pink Red Orange Yellow Green White

STORAGE TRAY CHOICE *(included in price)*

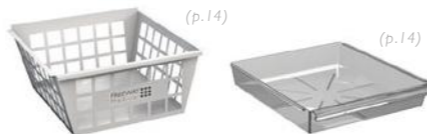

Double-space metal basket Single-space acrylic tray

VARI-CART OPEN - 500 SERIES / 11 TRAY SPACE



MEDICAL
RAIL
AS STANDARD

PRODUCT CODE
FW3100-11 Open Vari-Cart 500 Series

Our largest Open Vari-Cart with 11 tray spaces, like the rest of our range, can be fully customisable to your storage needs with a choice of any tray configuration of acrylic open trays or metal open baskets.

DIMENSIONS
Height = 1445mm Width = 540mm Depth = 540mm

PRODUCT ELEVATIONS

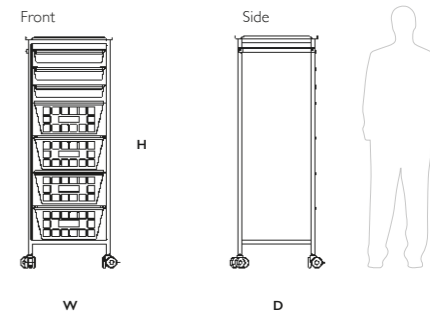

WORKTOP UPGRADES



Ultra durable Trespa® Stainless steel (capped edge)

HOOK-OVER ACCESSORIES *(optional)*



*Consumables not included.

STORAGE COMBINATIONS *(included in price)*



VARI-CART OPEN - 500 SERIES / 12 TRAY SPACE

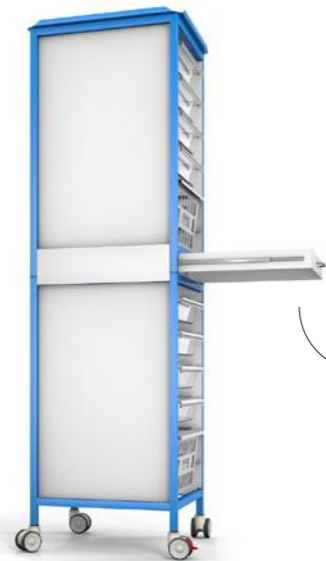

INTEGRAL
SHELF
BUILT IN

PRODUCT CODE
FW5040-12 Open Vari-Cart 500 Series

This 12 tray space model (Known as Vari-Store) is a high capacity storage unit using the same interchangeable tray and basket system. Due to its double-height frame construction, a handy pull-out shelf is neatly housed in the middle for use whilst re-stocking or rotating trays.

DIMENSIONS
Height = 1725mm Width = 540mm Depth = 540mm

PRODUCT ELEVATIONS

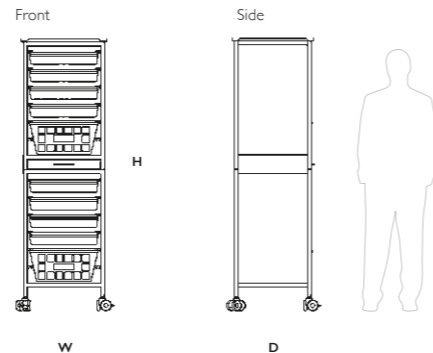

FRAME COLOURS (included in price)



Blue Purple Pink Red Orange Yellow Green White

STORAGE TRAY CHOICE (included in price)

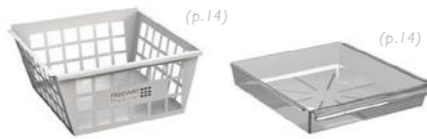

Double-space metal basket Single-space acrylic tray

VARI-CART OPEN - 500 SERIES / 12 TRAY SPACE / SHELVED



SEALED
REAR
PANEL

PRODUCT CODE
FW5080-12 Open Vari-Cart 500 Series Shelved

As the model opposite, but with re-positionable coated metal shelves instead of trays and baskets. The same pull-out shelf is also featured.

DIMENSIONS
Height = 1725mm Width = 540mm Depth = 540mm

PRODUCT ELEVATIONS

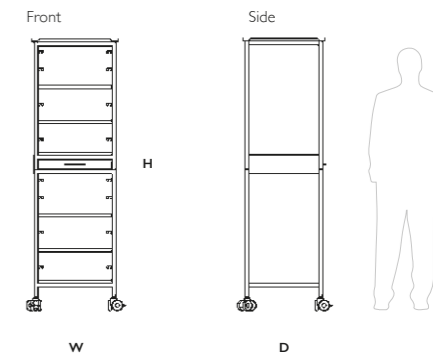

INTEGRATED PULL-OUT SHELF



An easy-to-use, temporary pull-out work surface that's built in as standard.

DURABLE REMOVABLE SHELVES (FW5080)



Nylon coated metal shelving system that is fully re-positionable or removed for easy cleaning.

STORAGE COMBINATIONS (FW5040 only)





500 SERIES VARI-CART ENCLOSED

- Clear acrylic or solid Trespa® door
- Sealed rear panel
- Digital locking/anti-tamper options
- 1 medical rail
- 8 frame colours available
- Any tray combination
- 4 ultra-durable castors/2 brakes
- Upgradeable worktop

- Simple modular construction - the Vari-Cart's greatest asset.



The Vari-Cart Enclosed is a secure, long-lasting investment, with durable materials that are easily deep-cleaned or replaced if damaged, thanks to the modular construction design. Simply disassemble the cart by removing just 4 thumbscrews.



VARI-CART ENCLOSED (CLEAR DOOR) - 500 SERIES / 4 TRAY SPACE



PRODUCT CODE
FW3100 ECD-4 Enclosed Vari-Cart 500 Series

The 4 tray space Enclosed Vari-Cart with a clear door is the smallest in the range, yet remains a key piece of equipment to many. The acrylic clear door option allows your stock to be protected and secure whilst remaining in easy view. Having 4 tray spaces gives you room for storage that can also be slipped under counters to be as unobtrusive as possible.

DIMENSIONS
Height = 710mm Width = 540mm Depth = 540mm

PRODUCT ELEVATIONS (Clear and Trespa®)

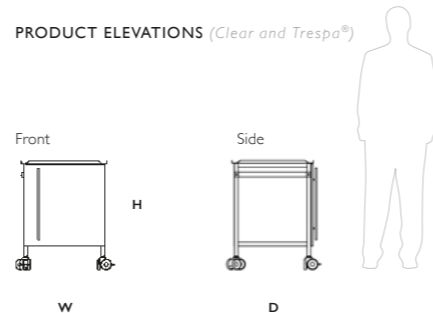

FRAME/WORKTOP COLOURS (included in price)



Blue Purple Pink Red Orange Yellow Green White

STORAGE TRAY CHOICE (included in price)

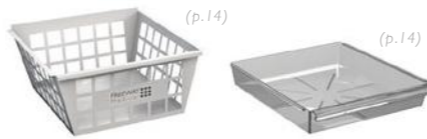

Double-space metal basket Single-space acrylic tray

VARI-CART ENCLOSED (TRESPA® DOOR) - 500 SERIES / 4 TRAY SPACE



PRODUCT CODE
FW3100 EWD-4 Enclosed Vari-Cart 500 Series

The opaque Trespa® door on any of our Enclosed Vari-Cart range will both conceal and protect the contents of the cart, allowing for manoeuvrability around wards without a worry. When not in use, simply slot this 4 tray space unit under a counter.

STORAGE COMBINATIONS (included in price)



WORKTOP UPGRADES



Ultra durable Trespa® Stainless steel (capped edge)

DIGITAL LOCK OPTION

Keyless everyday operation with master key for maintenance or forgotten codes.



ANTI-TAMPER OPTION

A simple solution for preventing and identifying loss or theft of stock with a one-time use plastic tie.



VARI-CART ENCLOSED (CLEAR DOOR) - 500 SERIES / 5 TRAY SPACE



PRODUCT CODE

FW3100 ECD-5 Enclosed Vari-Cart 500 Series

The last thing you need when you go to grab a piece of equipment or medicine is to find someone has forgotten to replace it or it is missing. Simple but effective, Freeway Medical have designed a curiously clever anti-tamper system for all of the Enclosed Vari-Cart range, to make sure you're not left in the lurch.

DIMENSIONS

Height = 815mm Width = 540mm Depth = 540mm

PRODUCT ELEVATIONS (Clear and Trespa®)

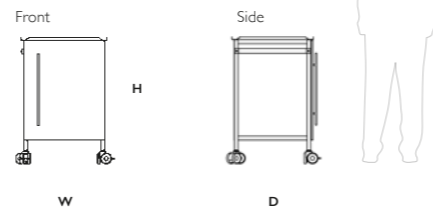

FRAME/WORKTOP COLOURS (included in price)



Blue Purple Pink Red Orange Yellow Green White

STORAGE TRAY CHOICE (included in price)

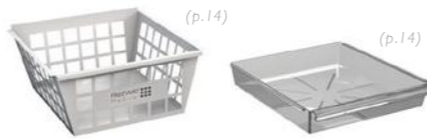

Double-space metal basket Single-space acrylic tray

VARI-CART ENCLOSED (TRESPA® DOOR) - 500 SERIES / 5 TRAY SPACE



PRODUCT CODE

FW3100 EWD-5 Enclosed Vari-Cart 500 Series

As standard on all height options of our Enclosed Vari-Cart range, the medical rail offers simple and effective convenience. Fitted to accommodate any of our accessories range, you'll find the medical rail transforms the use of any of the carts.

STORAGE COMBINATIONS (included in price)



WORKTOP UPGRADES



Ultra durable Trespa® Stainless steel (capped edge)

DIGITAL LOCK OPTION

Keyless everyday operation with master key for maintenance or forgotten codes.



ANTI-TAMPER OPTION

A simple solution for preventing and identifying loss or theft of stock with a one-time use plastic tie.



VARI-CART ENCLOSED (CLEAR DOOR) - 500 SERIES / 6 TRAY SPACE



PRODUCT CODE
FW3100 ECD-6 Enclosed Vari-Cart 500 Series

Our most popular height Enclosed Vari-Cart, the 6 tray space unit is the perfect size for universal or procedure use. Utilise the storage, utilise the solid, easy to clean worktop, utilise the security of the sealed unit – this Vari-Cart is multi-functional and is built with its purpose in mind.

DIMENSIONS
Height = 920mm Width = 540mm Depth = 540mm

PRODUCT ELEVATIONS (Clear and Trespa®)

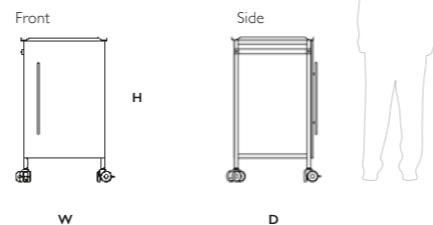

FRAME/WORKTOP COLOURS (included in price)



Blue Purple Pink Red Orange Yellow Green White

STORAGE TRAY CHOICE (included in price)

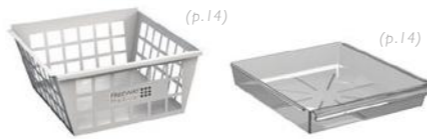

Double-space metal basket Single-space acrylic tray

VARI-CART ENCLOSED (TRESPA® DOOR) - 500 SERIES / 6 TRAY SPACE



DOOR
270°
OPENS

PRODUCT CODE
FW3100 EWD-6 Enclosed Vari-Cart 500 Series

If security and discretion are important, what better combination is there than a Trespa® door and a digital keyless lock? When fitted to the front of the Vari-Cart range of trolleys, the keyless lock can secure all drawers on just one single point.

STORAGE COMBINATIONS (included in price)



WORKTOP UPGRADES



Ultra durable Trespa® Stainless steel (capped edge)

DIGITAL LOCK OPTION

Keyless everyday operation with master key for maintenance or forgotten codes.



ANTI-TAMPER OPTION

A simple solution for preventing and identifying loss or theft of stock with a one-time use plastic tie.



VARI-CART ENCLOSED (CLEAR DOOR) - 500 SERIES / 7 TRAY SPACE



PRODUCT CODE
FW3100 ECD-7 Enclosed Vari-Cart 500 Series

Versatile in its use, effortless in its manoeuvrability and sleek in design, the Enclosed Vari-Cart is a valuable addition to any ward. All carts feature our high-performance, non-rusting, non-metal castors as standard, both easy to clean and easy to move. The rubberised wheels grip the floor, ensuring safe movement around the hospital.

DIMENSIONS
Height = 1025mm Width = 540mm Depth = 540mm

PRODUCT ELEVATIONS (Clear and Trespa®)

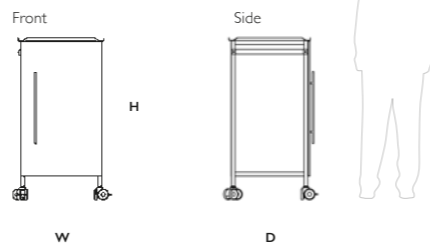

FRAME/WORKTOP COLOURS (included in price)



Blue Purple Pink Red Orange Yellow Green White

STORAGE TRAY CHOICE (included in price)

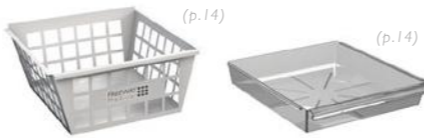

Double-space metal basket Single-space acrylic tray

VARI-CART ENCLOSED (TRESPA® DOOR) - 500 SERIES / 7 TRAY SPACE



PRODUCT CODE
FW3100 EWD-7 Enclosed Vari-Cart 500 Series

As standard on all Enclosed Vari-Carts, a capacity to open the door as far as 270° means no more struggling for access. The door opens wide to ensure easy retrieval and return of equipment, medicine and notes.

STORAGE COMBINATIONS (included in price)



WORKTOP UPGRADES



Ultra durable Trespa® Stainless steel (capped edge)

DIGITAL LOCK OPTION

Keyless everyday operation with master key for maintenance or forgotten codes.



ANTI-TAMPER OPTION

A simple solution for preventing and identifying loss or theft of stock with a one-time use plastic tie.



VARI-CART ENCLOSED (CLEAR DOOR) - 500 SERIES / 8 TRAY SPACE



FRAME/WORKTOP COLOURS (included in price)

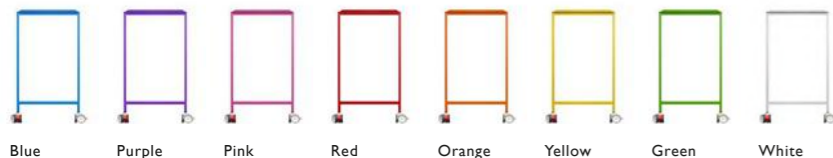

PRODUCT CODE
FW3100 ECD-8 Enclosed Vari-Cart 500 Series

Personalising equipment to meet the requirements of our clients is at the core of Freeway Medical and ensures your product is perfect for purpose. Speak to our team for a bespoke design that caters to all the details, be it big or small.

DIMENSIONS
Height = 1130mm Width = 540mm Depth = 540mm

PRODUCT ELEVATIONS (Clear and Trespa®)

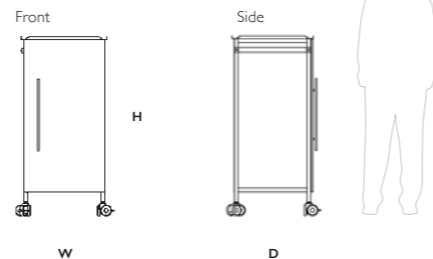

STORAGE TRAY CHOICE (included in price)

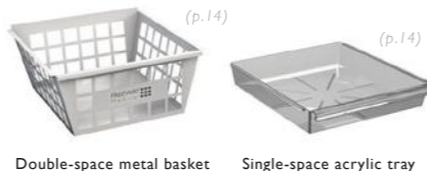

VARI-CART ENCLOSED (TRESPA® DOOR) - 500 SERIES / 8 TRAY SPACE



WORKTOP UPGRADES

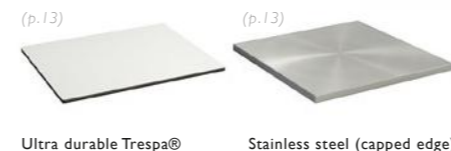

DIGITAL LOCK OPTION

Keyless everyday operation with master key for maintenance or forgotten codes.



PRODUCT CODE
FW3100 EWD-8 Enclosed Vari-Cart 500 Series

Ease, convenience, durability, quality... Our Enclosed Vari-Cart range meets all criteria, even coming fully assembled and ready to use immediately after unpacking – a perfect addition to any ward.

STORAGE COMBINATIONS (included in price)



ANTI-TAMPER OPTION

A simple solution for preventing and identifying loss or theft of stock with a one-time use plastic tie.



VARI-CART ENCLOSED (CLEAR DOOR) - 500 SERIES / 9 TRAY SPACE



PRODUCT CODE
FW3100 ECD-9 Enclosed Vari-Cart 500 Series

A clear view of drawers, effortless to move around the ward and offering plenty of storage? The 9 tray space Enclosed Vari-Cart, like the rest of the range, is available in many variations, with multiple options to choose from: colours, accessories or upgrades.

DIMENSIONS
Height = 1235mm Width = 540mm Depth = 540mm

PRODUCT ELEVATIONS (Clear and Trespa®)

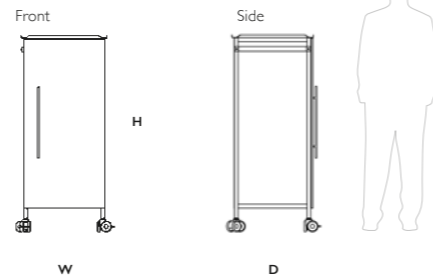

FRAME/WORKTOP COLOURS (included in price)

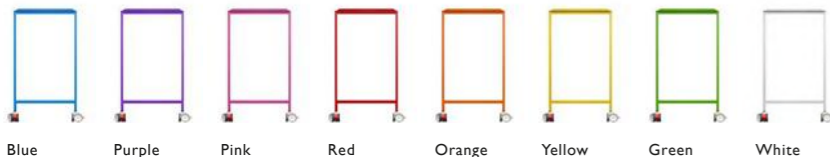

STORAGE TRAY CHOICE (included in price)

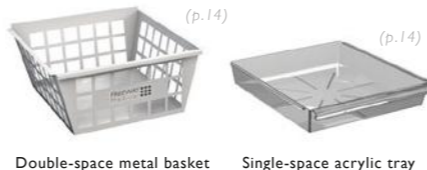

VARI-CART ENCLOSED (TRESPA® DOOR) - 500 SERIES / 9 TRAY SPACE



PRODUCT CODE
FW3100 EWD-9 Enclosed Vari-Cart 500 Series

A solid Trespa® door combined with the standard sealed rear panel ensures subtle storage and transportation, ensuring only the intended user can access and view contents.

STORAGE COMBINATIONS (included in price)



WORKTOP UPGRADES

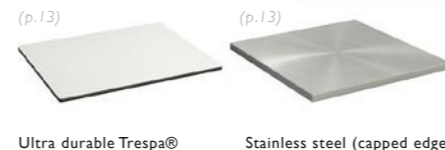

DIGITAL LOCK OPTION

Keyless everyday operation with master key for maintenance or forgotten codes.



ANTI-TAMPER OPTION

A simple solution for preventing and identifying loss or theft of stock with a one-time use plastic tie.



VARI-CART ENCLOSED (CLEAR DOOR) - 500 SERIES / 10 TRAY SPACE



PRODUCT CODE
FW3100 ECD-10 Enclosed Vari-Cart 500 Series

10 tray spaces and a customisable option for any tray combination, included in your standard price, means the Enclosed Vari-Cart units can be designed for your exact needs with metal baskets and acrylic drawers as storage combination options.

DIMENSIONS
Height = 1340mm Width = 540mm Depth = 540mm

PRODUCT ELEVATIONS (Clear and Trespa®)

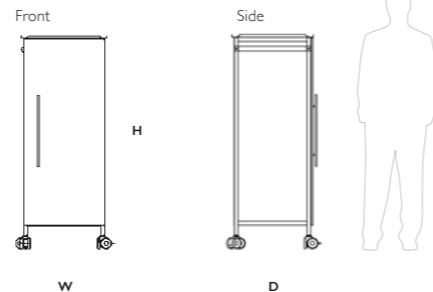

STORAGE TRAY CHOICE (included in price)

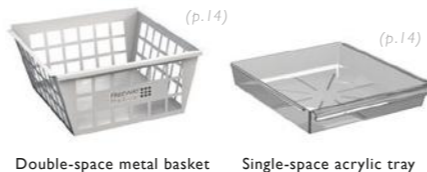

FRAME/WORKTOP COLOURS (included in price)

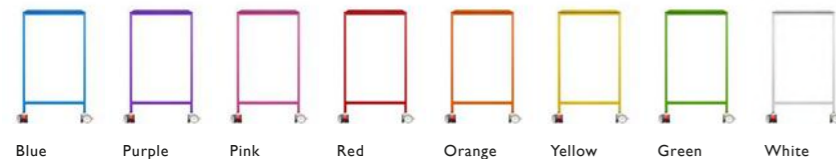

VARI-CART ENCLOSED (TRESPA® DOOR) - 500 SERIES / 10 TRAY SPACE



PRODUCT CODE
FW3100 EWD-10 Enclosed Vari-Cart 500 Series

Take your pick from one of our 8 available bold colours for your 10 tray space unit, or any other in the Enclosed Vari-Cart range, for a sleek design which is built to last with a super-tough nylon paint resistant to everyday knocks.

STORAGE COMBINATIONS (included in price)



WORKTOP UPGRADES

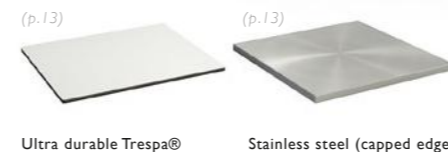

DIGITAL LOCK OPTION

Keyless everyday operation with master key for maintenance or forgotten codes.



ANTI-TAMPER OPTION

A simple solution for preventing and identifying loss or theft of stock with a one-time use plastic tie.



VARI-CART ENCLOSED (CLEAR DOOR) - 500 SERIES / 11 TRAY SPACE



PRODUCT CODE
FW3100 ECD-11 Enclosed Vari-Cart 500 Series

A clear acrylic door on our largest Enclosed Vari-Cart with 11 tray spaces could be the perfect solution for easy viewing whilst keeping your stock secure. The copious amount of enclosed storage space means you can transport medicine, notes and equipment easily in a secure unit for extra peace of mind.

DIMENSIONS
Height = 1445mm Width = 540mm Depth = 540mm

PRODUCT ELEVATIONS (Clear and Trespa®)

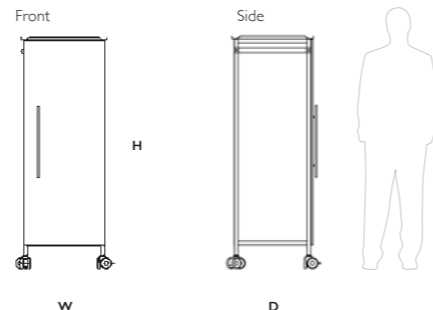

FRAME/WORKTOP COLOURS (included in price)

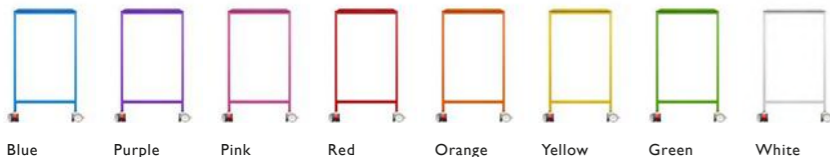

STORAGE TRAY CHOICE (included in price)

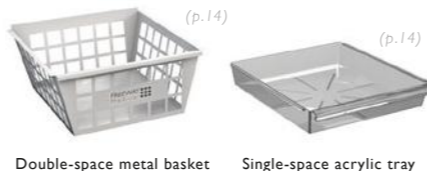

VARI-CART ENCLOSED (TRESPA® DOOR) - 500 SERIES / 11 TRAY SPACE



PRODUCT CODE
FW3100 EWD-11 Enclosed Vari-Cart 500 Series

The Enclosed Vari-Cart with 11 tray spaces is our largest standard option in this range, with a high-quality Trespa® door for transportable concealment and security for your equipment and medicine.

STORAGE COMBINATIONS (included in price)



WORKTOP UPGRADES

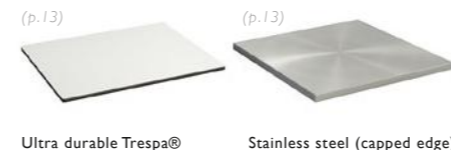

DIGITAL LOCK OPTION

Keyless everyday operation with master key for maintenance or forgotten codes.



ANTI-TAMPER OPTION

A simple solution for preventing and identifying loss or theft of stock with a one-time use plastic tie.



VARI-CART ENCLOSED (CLEAR DOOR) - 500 SERIES / 12 TRAY SPACE



PRODUCT CODE
FW5050 ECD-12 Enclosed Vari-Cart 500 Series

A clear acrylic door on our 12 tray space (Vari-Store) model allows easy viewing whilst keeping your stock secure. It's double-height frame construction features a handy pull-out shelf in the middle for use whilst re-stocking or rotating trays.

DIMENSIONS
Height = 1725mm Width = 540mm Depth = 540mm

PRODUCT ELEVATIONS (Clear and Trespa®)

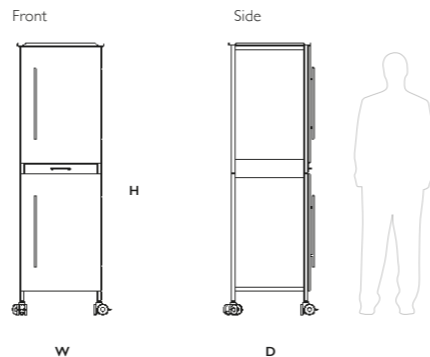

STORAGE TRAY CHOICE (included in price)

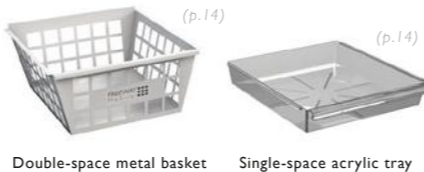

FRAME COLOURS (included in price)

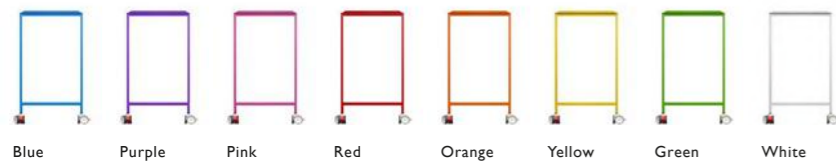

VARI-CART ENCLOSED (TRESPA® DOOR) - 500 SERIES / 12 TRAY SPACE



PRODUCT CODE
FW5060 EWD-12 Enclosed Vari-Cart 500 Series

As the 12 tray space model opposite, but with high-quality Trespa® doors for transportable concealment and security for your equipment and medicine.

STORAGE COMBINATIONS (included in price)



INTEGRATED PULL-OUT SHELF



An easy-to-use, temporary pull-out work surface that's built in as standard.

DIGITAL LOCK OPTION



Keyless everyday operation with master key for maintenance or forgotten codes.

ANTI-TAMPER OPTION



A simple solution for preventing and identifying loss or theft of stock with a one-time use plastic tie.

VARI-CART ENCLOSED (CLEAR DOOR) - 500 SERIES / 12 TRAY SPACE / SHELVED



SEALED
REAR
PANEL

INTEGRAL
SHELF
BUILT IN

PRODUCT CODE
FW5090 ECD-12 Enclosed Vari-Cart 500 Series

A clear acrylic door on our 12 tray space (Vari-Store) shelved model, allows easy viewing whilst keeping your stock secure. It's double-height frame construction features a handy pull-out shelf in the middle for use whilst re-stocking or rotating trays. Coated metal shelves are re-positionable.

DIMENSIONS
Height = 1725mm Width = 540mm Depth = 540mm

PRODUCT ELEVATIONS (Clear and Trespa®)

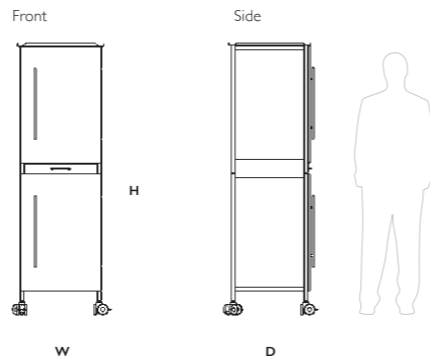

FRAME COLOURS (included in price)

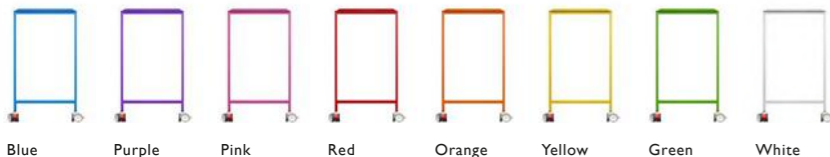

Blue Purple Pink Red Orange Yellow Green White

STORAGE TRAY CHOICE (included in price)

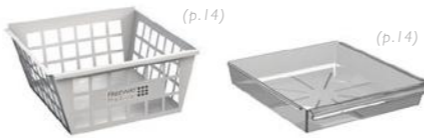

Double-space metal basket Single-space acrylic tray

VARI-CART ENCLOSED (TRESPA® DOOR) - 500 SERIES / 12 TRAY SPACE / SHELVED



WITH
TRESPA®
DOOR

PRODUCT CODE
FW5100 EWD-12 Enclosed Vari-Cart 500 Series

As the 12 tray space shelved model opposite, but with high-quality Trespa® doors for transportable concealment and security for your equipment and medicine.

DURABLE REMOVABLE SHELVES



Nylon coated metal shelving system that is fully re-positionable or removed for easy cleaning.

INTEGRATED PULL-OUT SHELF



An easy-to-use, temporary pull-out work surface that's built in as standard.

DIGITAL LOCK OPTION



Keyless everyday operation with master key for maintenance or forgotten codes.

(p.18)

ANTI-TAMPER OPTION



A simple solution for preventing and identifying loss or theft of stock with a one-time use plastic tie.

(p.19)

Freeway Medical

Unit 15-16,
Colthrop Business Park,
Colthrop Lane, Thatcham,
Berkshire, RG19 4NB.

Tel: 01635 866 717

Fax: 01635 866 347

Web: freewaymedical.co.uk

Email: sales@freewaymedical.co.uk