

SUMITOMO

SUMITOMO

SH700LHD-5B SH800LHD-5B

- Engine Rated Power (Net):
SH700LHD-5B.....345 kW·470 PS
SH800LHD-5B.....377 kW·510 PS
- Operating Weight:
SH700LHD-5B 68,800~70,500 kg
SH800LHD-5B 80,500~81,400 kg
- Bucket Capacity (ISO Heaped):
SH700LHD-5B 2.0~4.2 m³
SH800LHD-5B 3.3~5.0 m³



HYDRAULIC EXCAVATOR FOR REAL PERFORMANCE



**SUMITOMO (S.H.I.)
CONSTRUCTION MACHINERY CO., LTD.**

731-1 Naganumahara-cho, Inage-ku, Chiba, 263-0001 Japan
For further information please contact: Phone : +81-43-420-1829 Facsimile : +81-43-420-1907

We are constantly improving our products and therefore reserve the right to change designs and specifications without notice.
Illustrations may include optional equipment and accessories and may not include all standard equipment.





Performance Refined. Evolution Defined.

Engine and Hydraulics 04-05

- New Generation Engine System "SPACE 5+"
- SIH:S+
- New Working Mode

Durability and Maintenance 06-07

- Stronger Boom and Arm
- High-durability Bucket
- Full Track Guard Prevents Derailment (option)

Safety and Operator Comfort 08-10

- Spacious Cabin
- Comfortable Operator's Seat
- Message Display from LCD Monitor
- Optimized View from Cabin
- High-rigidity Cabin Structure

Customer and Product Support 11

Specifications 12-23

JAPANESE TECHNOLOGY

The world knows that Japanese designed and engineered products represent the highest quality, especially for Industrial Products. The hydraulic excavator is no exception when a totally integrated concept is required in design work involving key components, manufacturing engineering, and product quality assurance in the factory. SUMITOMO hydraulic excavators are designed and manufactured today to meet the global demands of our many customers with the concept of Performance, Reliability, and Fuel Efficiency foremost in our minds. This proven Japanese technology and quality gives SUMITOMO excavator customers total peace of mind and provide a complete solution for the demands of the construction industry.



**Performance Refined.
Evolution Defined.**

Engine and Hydraulics

New Generation Engine System "SPACE 5+"

The new engine system optimises fuel efficiency and environmental performance via the advanced common rail fuel injection system, cooled EGR system. At the same time, excellent response times are achieved.



Mode Selection by Throttle SUMITOMO UNIQUE DESIGN

There are three working modes available: SP (Super Power) for heavy duty applications, H (Heavy) for normal working conditions, A (Auto) for a wide range of operations.



Common Rail Type High-Pressure Fuel Injection System

The system is equipped with a common rail type high-compression fuel injection system, which permits high-precision injection from multiple injectors under ultra high-pressure. Precise control of injection time and injection quality at the rate of 1/1000 second optimizes combustion, improves combustion efficiency, and reduces PM (particulate matter) substantially.

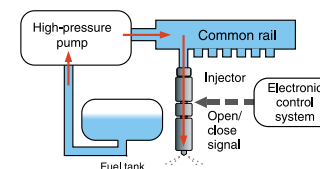

Cooled EGR System

The EGR (Exhaust Gas Recirculation) mixes exhaust gas, which is once exhausted, with the air intake that is taken in so as to lower the combustion temperature, thereby reducing NOx (nitrogen oxide). Adoption of the cooled EGR system, in which a water cooler is installed in the middle of the re-circulation pipe, permitting further decrease in the intake temperature, ensuring a better NOx reduction effect than the ordinary EGR.

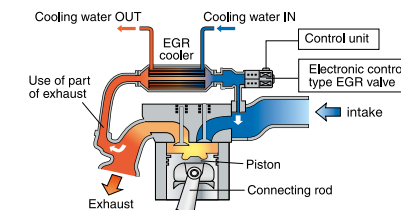

24 valve OHC Turbo Engine with Intercooler

When the inter-cooler cools the intake air, which is compressed by a turbocharger and has reached a high temperature, the density of the air increases and the suction efficiency increases. Therefore, NOx and PM can be reduced substantially, permitting high output and improvement of fuel efficiency simultaneously.

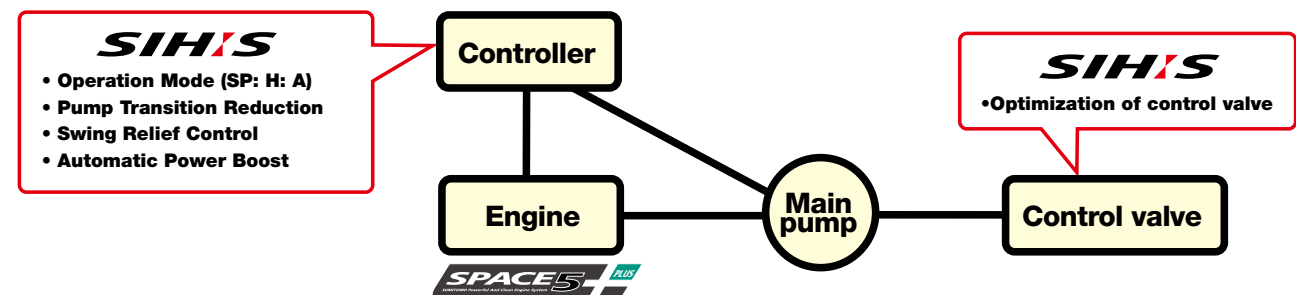
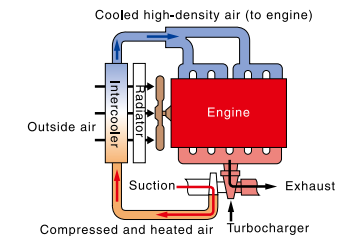

Pump Transition Control SUMITOMO UNIQUE DESIGN

In the case of sudden lever movement and high load activation, the newly developed hydraulic control system reduces the main pump oil flow intentionally and keeps the engine speed at a constant level. This enables a reduction in fuel consumption. In addition, this also reduces the level of exhaust smoke due to excessive fuel injection.

Quick and Smooth Control Response

A total review of the hydraulic circuit and miscellaneous hydraulic settings guarantee speedy and precise operation through a smooth control lever.

Increased Pump Efficiency

The new modified hydraulic pump structure lowers the oil leak volume in the pump which means improved pump efficiency and improved engine fuel efficiency.

Automatic Power Boost SUMITOMO UNIQUE DESIGN

The digging power increases automatically in quick response to the working conditions without switching operations during heavy-duty digging work. It is SUMITOMO'S original design and continues for 8 seconds.

Swing Relief Control SUMITOMO UNIQUE DESIGN

The hydraulic oil quantity required at the time of sudden swing motion is limited. The new hydraulic system can start the oil flow volume at the minimum level and then allow it to increase on demand. This optimum oil flow control significantly improves the fuel efficiency.

Durability and Maintenance

EMS permits fuss-free maintenances

EMS allows greasing of the front attachments at intervals of 1,000 hours and substantially reduces the greasing trouble and time, as well as the maintenance cost, also reducing a noise.

Greasing interval: 1,000 hours

* The greasing interval differs according to the operating conditions.

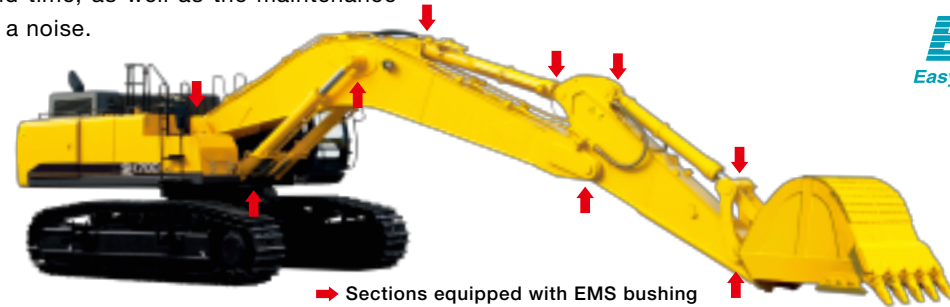

EMS bushing

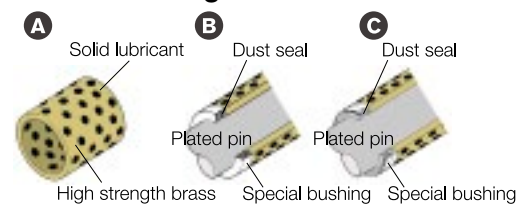

- A** A solid lubricant embedded in high strength brass forms a layer on the bush surface to prevent contact between metals, maintaining an excellent lubricated state to reduce abrasion of joints.
- B** The surface of the pin is plated to increase the surface hardness and improve the wear resistance accordingly.
- C** The dust seal has a double structure to prevent entry of abrasive materials and eliminating wear.



Precautionary use of EMS

- ① Grease impregnated. Greasing is still necessary at every 1,000 hours or six months, whichever comes earlier.
- ② Greasing is necessary after underwater digging operation, because the internal grease can be forced out due to being submerged.
- ③ When a breaker, crusher, or some other special attachment are installed, greasing is necessary every day, because the pins and bushes are different according to the attachment manufacturer.
- ④ Bucket pins should be cleaned thoroughly when removing or fitting new attachments.

High-Performance Return Filter

The hydraulic oil change interval is 5,000 hours, and the return filter change interval is 2,000 hours. One high performance return filter keeps the same level of filtering effect as a nephron.

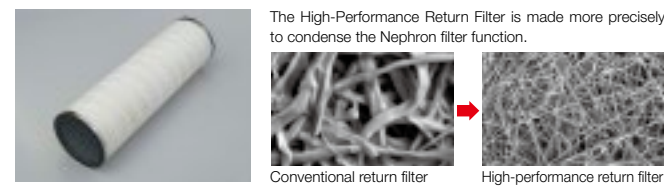

Hydraulic oil change: 5,000 hours • **Life of filter: 2,000 hours**

* The oil and filter change interval depends on the working conditions.

Stronger Boom and Arm

The strength of all joints has been increased to ensure durability, permitting operation at any site with severe working conditions and a large workload.

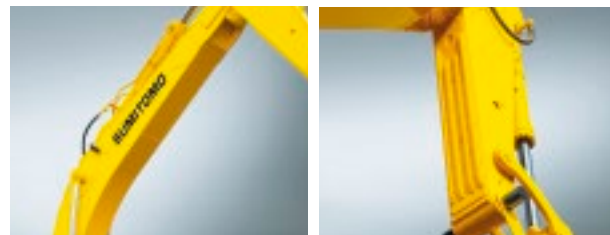

High-durability Bucket

The bucket is higher strength for impact and wear, providing long life and high performance.



High-rigidity Swing Frame

The rigidity and durability of the frame of the upper revolving unit has been increased to withstand rough handling during every operation.

Reinforced Double Grouser Shoe

The reinforced double grouser shoe permit operation on rough roads, steep slopes, and other work sites where large machines must be used.

Full Track Guard Prevents Derailment (option)

Full track guard is efficient in preventing derailment of the links (chain) and protecting the rollers.

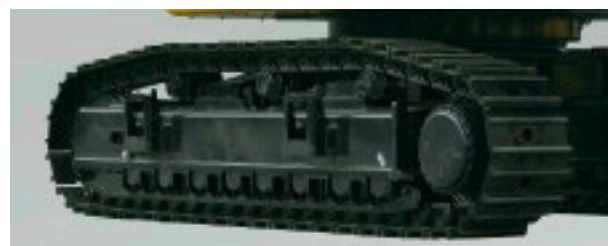

Ground Level Access to Engine Area Improves Preventative Maintenance

Parts cleaning and maintenance are possible from the ground without climbing onto the upper structure of the excavator body.

Remote fuel prefilter

A fuel prefilter is provided as standard equipment to reduce the likelihood of fuel clogging.

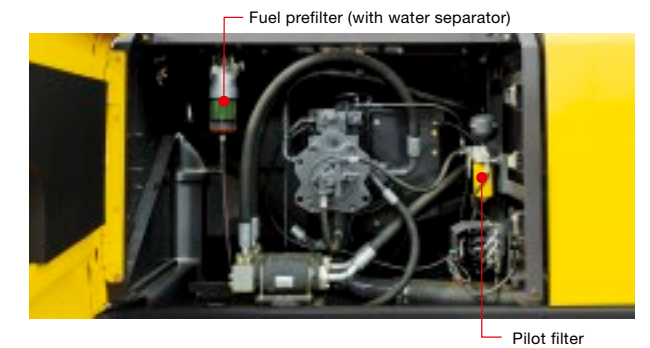
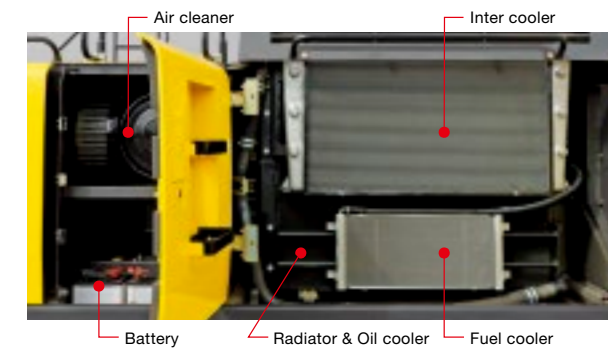

Hydraulically Driven Cooling Fan System

Optimum cooling control and reduction in noise according to the working environment.



Large Toolbox

A large toolbox is provided to completely store a large quantity of tools.



Easier Cleaning by Reversed Fan Rotation

The switch in the cab permits the cooling fan to rotate in reverse to remove dust from the radiator, oil cooler, inter cooler, and fuel cooler to prevent clogging.

Electric Indicator Permits Confirmation of Air Cleaner Clogging

The message on the monitor permits confirmation of air cleaner clogging. The indicator further permits confirmation of return filter clogging when the breaker piping and combination piping are installed.

The 900-liter Fuel Tank Ensures Extended Operation.

The large-capacity fuel tank reduce down time.

Fuel Tank

Stainless steel is used for the strainer that prevents dust entering during re-fueling. Furthermore, a maintenance hole is provided to permit easy periodical maintenance.



Stainless steel strainer



Maintenance hole for cleaning

Engine Oil Drain Coupler Prevents Oil Spattering

The engine oil pan is provided with a drain coupler. The supplied drain hose prevents oil spattering to facilitate draining work.



Engine Maintenance Steps

The engine room is designed to permit safe maintenance.



Catwalk on Both Sides

The house is provided with a catwalk on both sides to permit free movement during maintenance.





**Performance Refined.
Evolution Defined.**

SUMITOMO's Redesigned Cabin and Seat for Optimum Operator Comfort

The seat reclining system allows the operator to lay the seat flat and to rest on site without removing the headrest.



The KAB Seat Eliminates Vibration



Air suspension (option)

Safety and Operator Comfort

Operating Positions of Sliding Seat and Tilting Console

In addition to the tilting console that is adjustable in four steps vertically, the increased sliding distance ensures optimum working conditions.

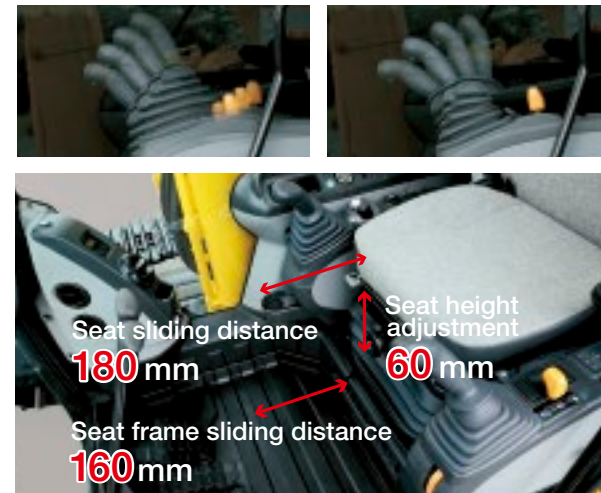

Simple to Read LCD Monitor and Switch Panel

In addition to the monitor that is easy to read during daytime as well as nighttime by changing the backlight to white, a simple and convenient universally designed switch panel is provided.



Fluid Filled Cab Mounts

Four fluid cab mounts reduce vibration and impact transmitted to the cabin, and improve the operators' sitting quality and reduce operator fatigue.

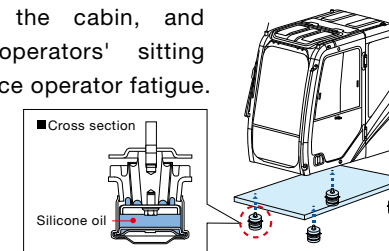

Automatic Air Conditioner with Round Outlets for Increased Comfort

The air outlets of the air conditioner are provided with round grills with wide adjusting angles. The efficiency of the air conditioner has been increased by pressurizing the cab to make it airtight, providing a comfortable space.



Flow Setting in 10 Patterns and Switching of Combined Circuit

The switch panel in the cab permits setting the flow rate for work with a maximum of ten different special attachments in advance. A circuit change for the breaker and crusher is also possible in the cab.



Adoption of Short Lever



Warning message

- | | |
|---------------------|-----------------------------------|
| 1. OVER HEAT | 7. OVER LOAD (option) |
| 2. ALTERNATOR | 8. AIR FILTER |
| 3. LOW FUEL | 9. CHECK ENGINE |
| 4. LOW OIL PRESSURE | 10. BOOST TEMP. HIGH |
| 5. LOW COOLANT | 11. CHECK BREAKER FILTER (option) |
| 6. ELEC. PROBLEM | |

Active condition message

1. ENG. PRE HEAT
2. AUTO WARM UP
3. ENG. IDLING
4. POWER UP
5. ENGINE STOP

Language menu

Japanese	Spanish	Turkish
English	Portuguese	Arabic
Thai	Dutch	Malay
Chinese	Danish	Indonesian
German	Norwegian	(Pictograph)
French	Swedish	
Italian	Finnish	

ISO-compliant Pressurized Cab to Prevent Dust Entry

The sealed and pressurized (sealing by pressure) cab prevents entry of dust from outside.

Convenient One-touch Muting of AM/FM Radio



An AM/FM radio is provided as standard equipment. The mute switch on the left lever permits one-touch muting of the radio.

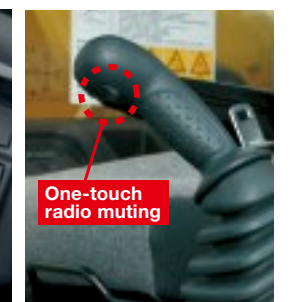

Safety and Operator Comfort



The Wide View Increases the Safety of Work

In addition to the wide front view, the down-right view is also made larger to enhance the safety of work.



Adoption of Gate Type Lock Lever

A gate type lock lever has been adopted to prevent sudden acceleration of the machine.



Large ISO-compliant Handrail

A large ISO-compliant handrail has been adopted to enhance safety when the operator gets on and off the machine.

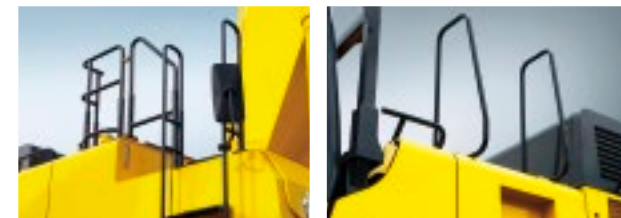

SH700LHD-5B

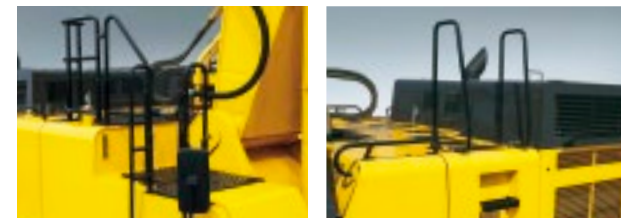

SH800LHD-5B

Adoption of Megavolume Horn

An easy-to-hear megavolume horn has been adopted to make the horn audible in any work site. Safety during operation will be enhanced.

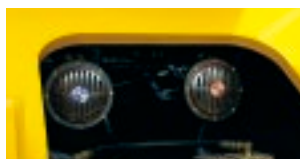

Emergency Escape Window

Allows operator to escape from the rear window in case of emergency.



Equipment that Enhances Safety



Seat belt



Rearview mirror

Safe and Easy Entry into and Exit from the Cab

A large handrail for easy opening/closing of the door and a non-slip plate are installed to permit the operator to get in and out of the cab easily.



Large handrail



New non-slip plate

Anti-theft Alarm System

SUMITOMO's unique anti-theft system can be activated by your SUMITOMO distributors at the time of purchase.



Anti-theft alarm system

Safety Equipment in case of an Emergency



Emergency stop switch

High-rigidity Cabin

The new cabin structure provides advanced operator protection.

- About **3 times** greater rigidity
- * As compared with SH700LHD/800LHD-3B

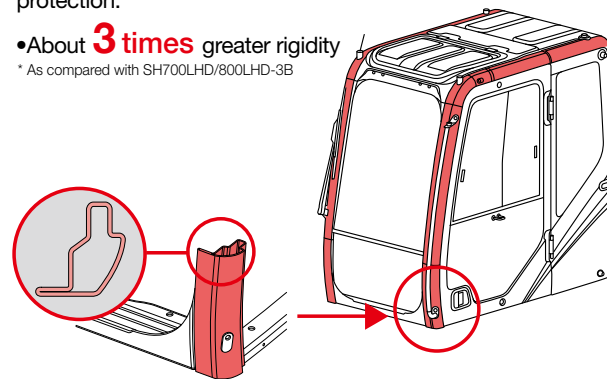

Customer and Product Support

SUMITOMO's total commitment to product and customer support

has enabled it grow into a world renowned manufacturer of hydraulic excavators.

Supported by a global sales and service network of over four hundred distributors representing hydraulic excavators manufactured by SUMITOMO, the company supply 70% of total production from Japan to all five continents.

A spread of over one thousand outlets offering excellent parts and service support has global coverage ensuring SUMITOMO hydraulic excavator users have at their disposal Regional Spare Parts Centers, technical repair shops and service vehicles carrying all the necessary equipment to service and repair any hydraulic excavator manufactured by SUMITOMO. SUMITOMO aims to produce the right products to meet all work applications and at the same time provide the highest level of more training and education to ensure complete product support quality throughout the service network in the world.

Specifications

SH700LHD-5B Technical data

Engine

SH700LHD-5B	
Model	ISUZU GH-6WG1X
Type	Electric control, water cooled, 4-cycle diesel, 6-cylinder in line, direct injection, turbocharged with air cooled inter-cooler
Rated output	345 kW (470 PS) at 1,800 min ⁻¹ (rpm)
Maximum torque	1,980 N·m at 1,500 min ⁻¹ (rpm)
Piston displacement	15,681 cc
Bore and stroke	147 mm x 154 mm
Starting system	24 V electric motor starting
Alternator	24 V, 50 A
Fuel tank	900 liters
Air filter	Double element

SIH:S

Two variable displacement axial piston pumps, one gear pump for pilot controls and the electronic-controlled engine of SPACE5 and SIH:S(SUMITOMO Intelligent Hydraulic System) includes: three working mode(SP,H,A) one-touch/automatic idling system and automatic power-boost.

Hydraulic pumps

Two variable displacement axial piston pumps provide power for boom, arm, bucket, swing and travel.

SH700LHD-5B	
Maximum oil flow	2 x 440 liters/min
Pilot pump max.oil flow	27 liters/min

Hydraulic motors

For travel: Two variable displacement axial piston motors.
For swing: Two fixed displacement axial piston motor.

Relief valve settings

Boom/arm/bucket 27.5 MPa(280 kgf/cm²)<Holding pressure(Boom down)>
36.3 MPa(370 kgf/cm²)<Holding pressure(Others)>
Boom/arm/bucket 31.4 MPa(320 kgf/cm²)<Working pressure>
Boom/arm/bucket 34.3 MPa(350 kgf/cm²)with Power-up<Working pressure>
Swing circuit 27.9 MPa(285 kgf/cm²)
Travel circuit 34.3 MPa(350 kgf/cm²)

Control valve

With boom/arm holding valve
One 4-spool valve for right track travel, bucket, boom and arm acceleration
One 5-spool valve for left track travel, auxiliary, swing, boom acceleration and arm

Oil filtration

Return filter 6 microns
Pilot filter 8 microns
Suction filter 105 microns

Hydraulic cylinders

SH700LHD-5B		
Boom	2	190 mm x 130 mm x 1,805 mm
Arm	1	200 mm x 140 mm x 2,025 mm
Bucket	1	180 mm x 125 mm x 1,465 mm
Bucket (Mass)	1	200 mm x 140 mm x 1,450 mm

Double-acting, bolt-up type cylinder end; hardened steel bushings
Installed in cylinder tube and rod ends.

Cab & controls

The cab is mounted on 4 fluid mountings. Features include safety glass front, rear and side windows, reclining/sliding cloth upholstered suspension seat with headrest and armrest, cigarette lighter, pop-up skylight window, and intermittent wiper with washer. The front window slides upward for storage, and the lower front window is removable. Control levers are located in 4 positions with tilting control consoles. Reliable soft-touch switches are a standard feature. An easy-to-read full-dot LCD monitor keeps operation in touch with critical machine functions.

Swing

Planetary reduction powered by an axial piston motor. Internal ring gear with grease cavity for pinion. Swing bearing is single-row shear type ball bearing. Dual stage relief valves for smooth swing deceleration and stops. Mechanical disc swing brake.

SH700LHD-5B	
Swing speed	0~6.5 min ⁻¹ (rpm)
Tail swing radius	4,300 mm
Swing torque	241 kN·m · 24,600 kgf·m

Undercarriage

X-style carbody is integrally welded for strength and durability. Grease cylinder track adjusters with shock absorbing springs. Undercarriage with lubricated rollers and idlers.

Type of shoe:sealed link shoe

Upper rollers -

Heat treated, mounted on steel bushings with fluorine resin, sealed for lifetime lubrication.

Lower rollers -

Heat treated, mounted on steel bushings with leaded tin bronze casting, sealed for lifetime lubrication.

Track adjustment -

Idler axles adjusted with grease cylinder integral on each side frame; adjustment yoke mechanism fitted with heavy duty recoil spring.

Number of rollers and shoes on each side

SH700LHD-5B	
Upper rollers	3
Lower rollers	8
Track shoes	47

Travel system

Two-speed independent hydrostatic system with compact axial motors for increased performance. Hydraulic motor powered output shaft coupled to a planetary reduction unit and track sprocket. All hydraulic components mounted within the width of side frame. Travel speed can be selected by switch panel. Hydraulically released disc parking brake is built into each motor.

SH700LHD-5B		
Travel speed	High	4.2 km/h
	Low	2.9 km/h
Drawbar pull	450 kN · 45,890 kgf	

Lubricant & coolant capacity

SH700LHD-5B	
Hydraulic system	650 liters
Hydraulic oil tank	310 liters
Fuel tank	900 liters
Cooling system	108 liters
Final drive case(per side)	15 liters
Swing drive case(per side)	13.5 liters
Engine crank case (with remote oil filter)	52 liters

Auxiliary hydraulic system

SH700LHD-5B		
Auxiliary piping type (option)	For Breaker	For Double (breaker & crusher) acting
Arm type	STD	STD
Bucket linkage type	STD	STD
Auxiliary hydraulic pump flow	max.420 liters/min	max.890 liters/min

Weight & ground pressure

SH700LHD-5B (Mass)			
Model	SH700LHD-5B (Mass)		
Shoe type	Shoe width	Operating weight	Ground pressure
Triple grouser shoe	650 mm	68 100 kg (70 500 kg)	100 kPa (104 kPa)
	750 mm	68 700 kg (71 200 kg)	88 kPa (91 kPa)

Digging force

SH700LHD-5B						
Model	SH700LHD-5B					SH700LHD-5B Mass
Arm length	3.0 m	3.55 m	4.11 m	5.0 m	3.0 m	
Bucket digging force <with auto power up>	ISO 6015	290 kN <317 kN>				331 kN <362 kN>
	SAE: PCSA	256 kN <280 kN>				302 kN <330 kN>
Arm digging force <with auto power up>	ISO 6015	244 kN <267 kN>	224 kN <245 kN>	202 kN <221 kN>	175 kN <192 kN>	276 kN <305 kN>
	SAE: PCSA	235 kN <257 kN>	215 kN <235 kN>	195 kN <213 kN>	170 kN <186 kN>	229 kN <250 kN>

Principal specifications & dimensions

Model		SH700LHD-5B	SH700LHD-5B Mass
Base	Boom Length	7.7 m	6.58 m
	Arm Length	3.55 m	3.0 m
	Bucket capacity (ISO heaped)	2.9 m ³	4.2 m ³
	Operating weight	68 100 kg	70 500 kg
Engine	Make & model	ISUZU GH-6WG1X	
	Rated output	345 kW(469 PS)/1 800 min ⁻¹	
	Displacement	15 700 ml(cc)	
Hydraulic System	Main pump	2 variable displacement axial piston pumps with regulating system	
	Max Pressure (with auto power up)	31.4 MPa 34.3 MPa	
	Travel motor	Variable displacement axial piston motor	
	Parking brake type	Mechanical disc brake	
	Swing motor	Fixed displacement axial piston motor	
	Travel speed	4.2/2.9 km/h	
Performance	Traction force	450 kN	
	Grade ability	70% <35°>	
	Ground pressure	100 kPa	104 kPa
	Swing speed	6.5 min ⁻¹	
	Bucket	317 kN	362 kN
Other	Arm	245 kN	305 kN
	Fuel tank	900 liter	
	Hydraulic fluid tank	310 liter	

Lifting capacity

- Notes: 1. Ratings are based on SAE J/ISO 10567.
 2. Lifting capacity does not exceed 75% of tipping load with the machine on firm, level ground or 87% full hydraulic capacity.
 3. The load point is a hook (not standard equipment) located on the back of the bucket.
 4. *Indicates load limited by hydraulic capacity.
 5. 0m = Ground.

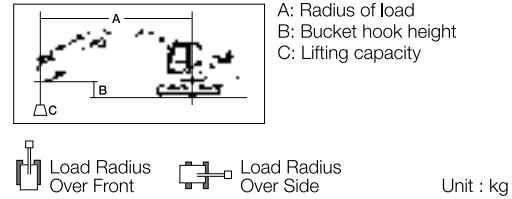

SH700LHD-5B SHOE : 650 (mm)G ARM LENGTH = 3.00 (m) BOOM : 7.70 (m)
 BUCKET : SAE/PCSA 2.9 (m³) MAXIMUM REACH = 11.02 (m)

Bucket Hook Height	Radius of Load																											
	Max. Radius		12 m		11 m		10 m		9 m		8 m		7 m		6 m		5 m		4 m		3 m		Min. Radius					
	☺	☹	☺	☹	☺	☹	☺	☹	☺	☹	☺	☹	☺	☹	☺	☹	☺	☹	☺	☹	☺	☹	☺	☹				
8 m	10 894*	9.2	10 894*	9.2																				12 737*	8.23	12 737*	8.23	
7 m	8 853*	10.07	8 853*	10.07																					13 497*	7.83	13 497*	7.83
6 m	9 915*	10.46	8 244	10.46																					15 507*	6.97	15 507*	6.97
5 m	9 089*	10.74	7 660	10.74																					30 687*	4.07	30 687*	4.07
4 m	9 378*	10.92	7 254	10.92																					20 019*	4.54	20 019*	4.54
3 m	9 794*	11.01	6 994	11.01																					14 090*	4.75	14 090*	4.75
2 m	10 358*	11	6 867	11																					11 169*	4.74	11 169*	4.74
1 m	10 970*	10.9	6 867	10.9																					9 559*	4.5	9 559*	4.5
0 m	11 212	10.71	7 003	10.71																					8 755*	3.98	8 755*	3.98
-1 m	11 683	10.41	7 298	10.41																					12 921*	3.39	12 921*	3.39
-2 m	12 451	10	7 795	10																					16 094*	2.77	16 094*	2.77
-3 m	12 869*	9.47	8 573	9.47																					17 867*	2.15	17 867*	2.15
-4 m	12 729*	8.79	9 791	8.79																					24 456*	2.36	24 456*	2.36
-5 m	12 272*	7.92	11 790	7.92																					26 839*	2.91	26 839*	2.91
-6 m	11 101*	6.79	11 101*	6.79																					17 559*	4.12	17 559*	4.12

SH700LHD-5B SHOE : 650 (mm)G ARM LENGTH = 3.55 (m) BOOM : 7.70 (m)
 BUCKET : SAE/PCSA 2.9 (m³) MAXIMUM REACH = 11.14 (m)

Bucket Hook Height	Radius of Load																											
	Max. Radius		12 m		11 m		10 m		9 m		8 m		7 m		6 m		5 m		4 m		3 m		Min. Radius					
	☺	☹	☺	☹	☺	☹	☺	☹	☺	☹	☺	☹	☺	☹	☺	☹	☺	☹	☺	☹	☺	☹	☺	☹				
9 m	8 800*	8.81	8 800*	8.81																					8 829*	8.81	8 829*	8.81
8 m	7 818*	9.69	7 818*	9.69																					10 927*	8.72	10 927*	8.72
7 m	7 862*	10.2	7 862*	10.2																					12 299*	8.37	12 299*	8.37
6 m	8 015*	10.59	8 015*	10.59																					13 674*	7.67	13 674*	7.67
5 m	8 275*	10.87	7 568	10.87																					17 739*	6.19	17 739*	6.19
4 m	8 649*	11.05	7 150	11.05																					18 164*	3.91	18 164*	3.91
3 m	9 155*	11.13	6 874	11.13																					12 477*	4.16	12 477*	4.16
2 m	9 824*	11.12	6 724	11.12																					9 887*	4.14	9 887*	4.14
1 m	10 704*	11.03	6 698	11.03																					8 614*	3.86	8 614*	3.86
0 m	10 939	10.83	6 802	10.83																					11 467*	3.46	11 467*	3.46
-1 m	11 358	10.54	7 056	10.54																					14 060*	3.07	14 060*	3.07
-2 m	12 056	10.14	7 498	10.14																					16 655*	2.51	16 655*	2.51
-3 m	13 145	9.61	8 200	9.61																					19 884*	2.35	19 884*	2.35
-4 m	13 337*	8.94	9 303	8.94																					21 700*	2.35	21 700*	2.35
-5 m	13 325*	8.09	11 105	8.09																					23 583*	2.35	23 583*	2.35
-6 m	12 901*	6.99	12 901*	6.99																					15 619*	3.24	15 619*	3.24

SH700LHD-5B SHOE : 650 (mm)G ARM LENGTH = 4.11 (m) BOOM : 7.70 (m)
 BUCKET : SAE/PCSA 2.3 (m³) MAXIMUM REACH = 11.63 (m)

Bucket Hook Height	Radius of Load																														
	Max. Radius		12 m		11 m		10 m		9 m		8 m		7 m		6 m		5 m		4 m		3 m		Min. Radius								
	☺	☹	☺	☹	☺	☹	☺	☹	☺	☹	☺	☹	☺	☹	☺	☹	☺	☹	☺	☹	☺	☹	☺	☹							
9 m	6 777*	9.58	6 777*	9.58																								7 481*	9.35	7 481*	9.35
8 m	6 450*	10.26	6 450*	10.26																								9 083*	9.28	9 083*	9.28
7 m	6 473*	10.74	6 473*	10.74																								10 608*	8.98	10 608*	8.98
6 m	6 582*	11.1	6 582*	11.1																								12 235*	8.39	12 235*	8.39
5 m	6 774*	11.37	6 774*	11.37																								14 417*	7.34	14 417*	7.34
4 m	7 055*	11.54	6 700	11.54																								20 592*	3.44	20 592*	3.44
3 m	7 437*	11.63	6 448	11.63																								11 933*	3.72	11 933*	3.72
2 m	7 940*	11.62	6 305	11.62																								8 671*	3.7	8 671*	3.7
1 m	8 598*	11.53	6 269	11.53																								7 164*	3.38	7 164*	3.38
0 m	9 462*	11.34	6 344	11.34																								9 550*	2.98	9 550*	2.98
-1 m	10 552	11.06	6 545	11.06																								11 831*	2.63	11 831*	2.63
-2 m	11 117	10.68	6 901	10.68																								13 399*	2.35	14 105*	2.35
-3 m	11 990	10.18	7 465	10.18																								15 830*	2.35	15 830*	2.35
-4 m	12 820*	9.55	8 333	9.55																								21 253*	2.35	19 603*	2.35
-5 m	12 955*	8.76	9 699	8.76																								25 890*	2.35	23 807*	2.35
-6 m	12 891*	7.76	12 016	7.76																								19 139*	3.84	19 139*	3.84
-7 m	12 231*	6.44	12 231*	6.44																								13 431*	13 431*	16 040*	16 040*

SH700LHD-5B SHOE : 650 (mm)G ARM LENGTH = 5.00 (m) BOOM : 7.70 (m)
 BUCKET : SAE/PCSA 2.0 (m³) MAXIMUM REACH = 12.63 (m)

Bucket Hook Height	Radius of Load																																	
	Max. Radius		12 m		11 m		10 m		9 m		8 m		7 m		6 m		5 m		4 m		3 m		Min. Radius											
	☺	☹	☺	☹	☺	☹	☺	☹	☺	☹	☺	☹	☺	☹	☺	☹	☺	☹	☺	☹	☺	☹	☺	☹										
9 m	5 271*	10.68	5 271*	10.68																											6 235*	10.23	6 235*	10.23
8 m	4 731*	11.38	4 731*	11.38																											7 118*	10.17	7 118*	10.17
7 m	4 704*	11.81	4 704*	11.81																											7 948*	9.92	7 948*	9.92
6 m	4 737*	12.14	4 737*	12.14																											8 924*	9.45	8 924*	9.45
5 m	4 826*	12.39	4 826*	12.39																											10 449*	8.69	10 449*	8.69
4 m	4 973*	12.55	4 973*	12.55																											14 017*	7.4	14 017*	7.4
3 m	5 183*	12.62	5 183*	12.62																											20 066*	3.48	20 066*	3.48
2 m	5 464*	12.62	5 345	12.62																											10 208*	3.45	10 208*	3.45
1 m	5 831*	12.53	5 303	12.53																														

Specifications

SH800LHD-5B Technical data

Engine

SH800LHD-5B	
Model	ISUZU GH-6WG1X
Type	Electric control, water cooled, 4-cycle diesel, 6-cylinder in line, direct injection, turbocharged with air cooled inter-cooler
Rated output	377 kW (510 PS) at 1,800 min ⁻¹ (rpm)
Maximum torque	2,138 N·m at 1,500 min ⁻¹ (rpm)
Piston displacement	15,681 cc
Bore and stroke	147 mm x 154 mm
Starting system	24 V electric motor starting
Alternator	24 V, 50 A
Fuel tank	900 liters
Air filter	Double element

SIH:S

Two variable displacement axial piston pumps, one gear pump for pilot controls and the electronic-controlled engine of SPACE5 and SIH:S(SUMITOMO Intelligent Hydraulic System) includes: three working mode(SP,H,A) one-touch/automatic idling system and automatic power-boost.

Hydraulic pumps

Two variable displacement axial piston pumps provide power for boom, arm, bucket, swing and travel.

SH800LHD-5B	
Maximum oil flow	2 x 500 liters/min
Pilot pump max.oil flow	27 liters/min

Hydraulic motors

For travel: Two variable displacement axial piston motors.
For swing: Two fixed displacement axial piston motor.

Relief valve settings

Boom/arm/bucket ∙∙∙ 36.3 MPa(370 kgf/cm²)<Holding pressure>
Boom/arm/bucket ∙∙∙ 31.4 MPa(320 kgf/cm²)<Working pressure>
Boom/arm/bucket ∙∙∙ 34.3 MPa(350 kgf/cm²)with Power-up<Working pressure>
Swing circuit ∙∙∙∙∙ 26.5 MPa(270 kgf/cm²)
Travel circuit ∙∙∙∙∙ 34.3 MPa(350 kgf/cm²)

Control valve

With boom/arm holding valve
One 4-spool valve for right track travel, bucket, boom and arm acceleration
One 5-spool valve for left track travel, auxiliary, swing, boom acceleration and arm

Oil filtration

Return filter ∙∙∙∙∙ 6 microns
Pilot filter ∙∙∙∙∙ 8 microns
Suction filter ∙∙∙∙∙ 105 microns

Hydraulic cylinders

SH800LHD-5B		
Boom	2	200 mm x 140 mm x 1,893 mm
Arm	1	215 mm x 150 mm x 2,290 mm
Arm (Mass)	1	215 mm x 150 mm x 2,175 mm
Bucket	1	190 mm x 130 mm x 1,555 mm
Bucket (Mass)	1	215 mm x 150 mm x 1,520 mm

Double-acting, bolt-up type cylinder end; hardened steel bushings
Installed in cylinder tube and rod ends.

Cab & controls

The cab is mounted on 4 fluid mountings. Features include safety glass front, rear and side windows, reclining/sliding cloth upholstered suspension seat with headrest and armrest, cigarette lighter, pop-up skylight window, and intermittent wiper with washer. The front window slides upward for storage, and the lower front window is removable. Control levers are located in 4 positions with tilting control consoles. Reliable soft-touch switches are a standard feature. An easy-to-read full-dot LCD monitor keeps operation in touch with critical machine functions.

Swing

Planetary reduction powered by an axial piston motor. Internal ring gear with grease cavity for pinion. Swing bearing is single-row shear type ball bearing. Dual stage relief valves for smooth swing deceleration and stops. Mechanical disc swing brake.

SH800LHD-5B	
Swing speed	0~6.4 min ⁻¹ (rpm)
Tail swing radius	4,300 mm
Swing torque	266 kN·m · 27,100 kgf·m

Undercarriage

X-style carbody is integrally welded for strength and durability. Grease cylinder track adjusters with shock absorbing springs. Undercarriage with lubricated rollers and idlers.

Type of shoe: sealed link shoe

Upper rollers -

Heat treated, mounted on steel bushings with fluorine resin, sealed for lifetime lubrication.

Lower rollers -

Heat treated, mounted on steel bushings with leaded tin bronze casting, sealed for lifetime lubrication.

Track adjustment -

Idler axles adjusted with grease cylinder integral on each side frame; adjustment yoke mechanism fitted with heavy duty recoil spring.

Number of rollers and shoes on each side

SH800LHD-5B	
Upper rollers	3
Lower rollers	9
Track shoes	51

Travel system

Two-speed independent hydrostatic system with compact axial motors for increased performance. Hydraulic motor powered output shaft coupled to a planetary reduction unit and track sprocket. All hydraulic components mounted within the width of side frame. Travel speed can be selected by switch panel. Hydraulically released disc parking brake is built into each motor.

SH800LHD-5B		
Travel speed	High	4.3 km/h
	Low	3.0 km/h
Drawbar pull	502 kN · 51,190 kgf	

Lubricant & coolant capacity

SH800LHD-5B	
Hydraulic system	720 liters
Hydraulic oil tank	310 liters
Fuel tank	900 liters
Cooling system	108 liters
Final drive case(per side)	13.8 liters
Swing drive case(per side)	5.7 liters
Engine crank case (with remote oil filter)	52 liters

Auxiliary hydraulic system

SH800LHD-5B		
Auxiliary piping type (option)	For Breaker	For Double (breaker & crusher) acting
Arm type	STD	STD
Bucket linkage type	STD	STD
Auxiliary hydraulic pump flow	max.480 liters/min	max.1 000 liters/min

Weight & ground pressure

SH800LHD-5B (Mass)			
Model	SH800LHD-5B (Mass)		
Shoe type	Shoe width	Operating weight	Ground pressure
Triple grouser shoe	650 mm	80 100 kg (81 400 kg)	109 kPa (111 kPa)
	750 mm	80 800 kg (82 100 kg)	96 kPa (99 kPa)

Digging force

Model		SH800LHD-5B			SH800LHD-5B Mass
Arm length		3.66 m	4.44 m	5.62 m	2.98 m
Bucket digging force <with auto power up>	ISO 6015	330 kN <361 kN>			420 kN <460 kN>
	SAE: PCSA	294 kN <322 kN>			412 kN <377 kN>
Arm digging force <with auto power up>	ISO 6015	274 kN <300 kN>	232 kN <253 kN>	202 kN <221 kN>	314 kN <343 kN>
	SAE: PCSA	265 kN <290 kN>	225 kN <247 kN>	197 kN <216 kN>	332 kN <304 kN>

Principal specifications & dimensions

Model		SH800LHD-5B	SH800LHD-5B Mass
Base	Boom Length	8.4 m	7.25 m
	Arm Length	3.66 m	2.98 m
	Bucket capacity (ISO heaped)	3.3 m ³	5.0 m ³
	Operating weight	80 100 kg	81 400 kg
Engine	Make & model	ISUZU GH-6WG1X	
	Rated output	377 kW (513 PS)/1 800 min ⁻¹	
Hydraulic System	Displacement	15 700 ml (cc)	
	Main pump	2 variable displacement axial piston pumps with regulating system	
	Max Pressure (with auto power up)	31.4 MPa 34.3 MPa	
	Travel motor	Variable displacement axial piston motor	
	Parking brake type	Mechanical disc brake	
Performance	Swing motor	Fixed displacement axial piston motor	
	Travel speed	4.3/3.0 km/h	
	Traction force	502 kN	
	Grade ability	70% <35°>	
	Ground pressure	109 kPa	111 kPa
	Swing speed	6.4 min ⁻¹	
Other	Bucket	361 kN	460 kN
	Arm	300 kN	343 kN
	Fuel tank	900 liter	
	Hydraulic fluid tank	310 liter	

Dimensions

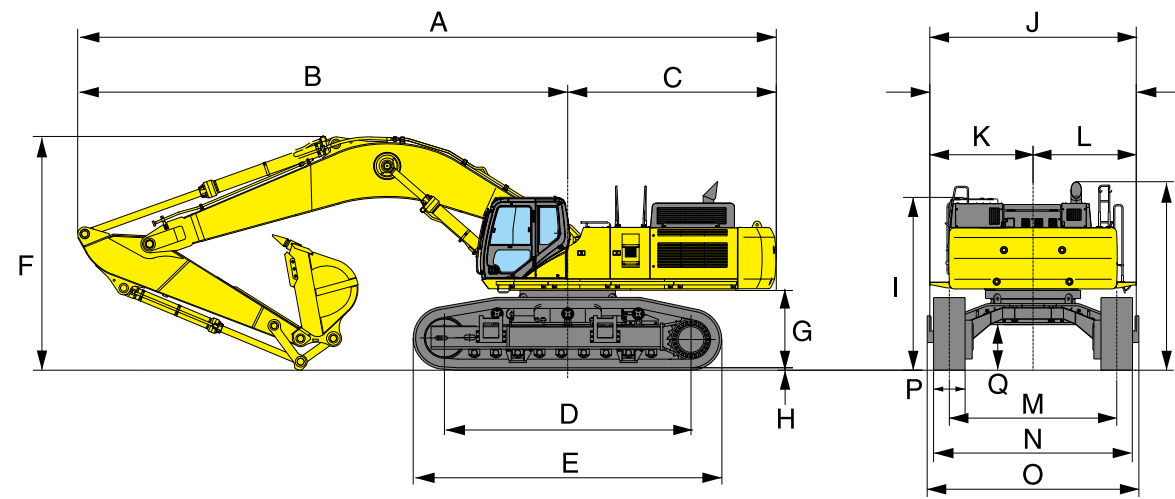

Model	SH700LHD-5B				SH700LHD-5B Mass
Arm length	3.0 m	3.55 m	4.11 m	5.0 m	3.0 m
A Overall length	13 250 mm	13 290 mm	13 300 mm	13 170 mm	12 280 mm
B Length from center of machine (to arm top)	9 280 mm	9 320 mm	9 330 mm	9 200 mm	8 310 mm
C Upper structure rear end radius					3 970 mm
D Center to center of wheels					4 700 mm
E Overall track length					5 880 mm
F Overall height	4 370 mm	4 300 mm	4 470 mm	5 160 mm	5 030 mm
G Clearance height under upper structure					1 510 mm
H Shoe lug height					50 mm
I Cab height					3 480 mm
J Upper structure overall width with catwalk					3 990 mm
K Width from center of machine (left side)					1 995 mm
L Width from center of machine (right side)					1 995 mm
M Track gauge (Retract)					3 250 mm (2 740 mm)
N Overall width without lower step (Retract)					3 900 mm (3 390 mm)
O Overall width with lower step (Retract)					4 140 mm (3 630 mm)
P Std. Shoe width					650 mm
Q Minimum ground clearance					825 mm

Model	SH800LHD-5B			SH800LHD-5B Mass
Arm length	3.66 m	4.44 m	5.62 m	2.98 m
A Overall length	14 360 mm	14 320 mm	13 920 mm	13 230 mm
B Length from center of machine (to arm top)	10 080 mm	10 040 mm	9 640 mm	8 950 mm
C Upper structure rear end radius				4 280 mm
D Center to center of wheels				5 070 mm
E Overall track length				6 360 mm
F Overall height	4 810 mm	5 000 mm	6 170 mm	5 000 mm
G Clearance height under upper structure				1 590 mm
H Shoe lug height				50 mm
I Cab height				3 570 mm
J Upper structure overall width with catwalk				4 250 mm
K Width from center of machine (left side)				2 125 mm
L Width from center of machine (right side)				2 125 mm
M Track gauge (Retract)				3 450 mm (2 830 mm)
N Overall width without lower step (Retract)				4 100 mm (3 480 mm)
O Overall width with lower step (Retract)				4 360 mm (3 740 mm)
P Std. Shoe width				650 mm
Q Minimum ground clearance				890 mm

Working Range

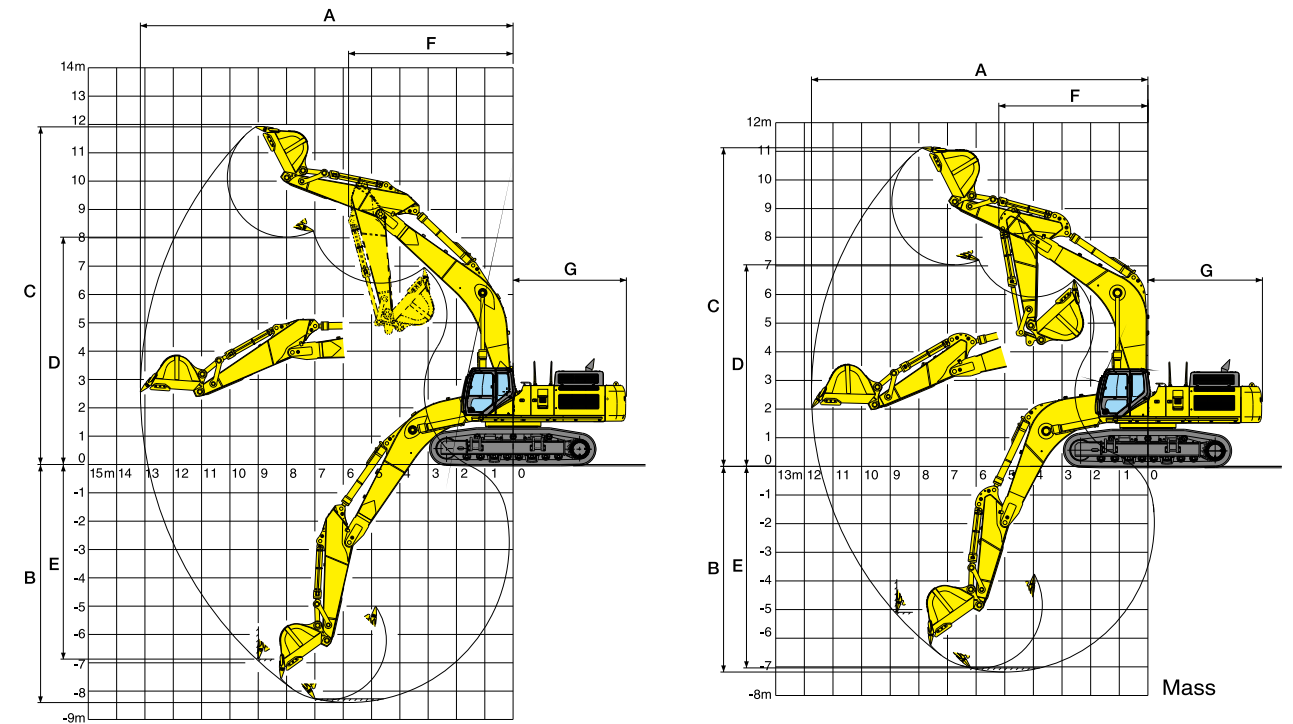

Model	SH700LHD-5B			
Arm length	3.0 m	3.55 m	4.11 m	5.0 m
Boom length	7.7 m			
A Max digging radius	12 870 mm	13 160 mm	13 650 mm	14 600 mm
B Max digging depth	7 870 mm	8 400 mm	8 970 mm	9 850 mm
C Max digging height	12 400 mm	11 920 mm	12 040 mm	12 700 mm
D Max dumping height	8 330 mm	8 020 mm	8 160 mm	8 710 mm
E Max vertical wall cut depth	6 850 mm	6 870 mm	7 360 mm	8 630 mm
F Min. front swing radius	5 860 mm	5 810 mm	5 680 mm	5 700 mm
G Rear end swing radius	4 000 mm			

Model	SH700LHD-5B Mass
Arm length	3.0 m
Boom length	6.58 m
A Max digging radius	11 660 mm
B Max digging depth	7 140 mm
C Max digging height	10 920 mm
D Max dumping height	7 000 mm
E Max vertical wall cut depth	4 910 mm
F Min. front swing radius	5 170 mm
G Rear end swing radius	4 000 mm

Model	SH800LHD-5B		
Arm length	3.66 m	4.44 m	5.62 m
Boom length	8.4 m		
A Max digging radius	14 120 mm	14 940 mm	16 110 mm
B Max digging depth	8 690 mm	9 470 mm	10 560 mm
C Max digging height	12 910 mm	13 600 mm	14 300 mm
D Max dumping height	8 920 mm	9 510 mm	10 170 mm
E Max vertical wall cut depth	6 440 mm	7 750 mm	9 110 mm
F Min. front swing radius	6 270 mm	6 130 mm	6 210 mm
G Rear end swing radius	4 300 mm		

Model	SH800LHD-5B Mass
Arm length	2.98 m
Boom length	7.25 m
A Max digging radius	12 310 mm
B Max digging depth	7 030 mm
C Max digging height	11 760 mm
D Max dumping height	7 890 mm
E Max vertical wall cut depth	4 250 mm
F Min. front swing radius	5 390 mm
G Rear end swing radius	4 300 mm

Transportation

Upperstructure

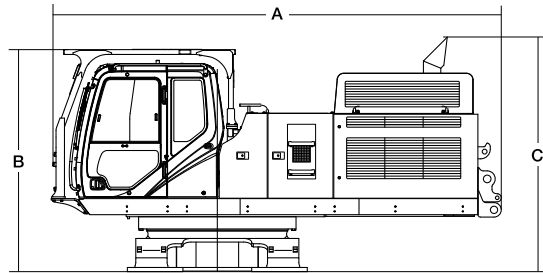

Side lower frame

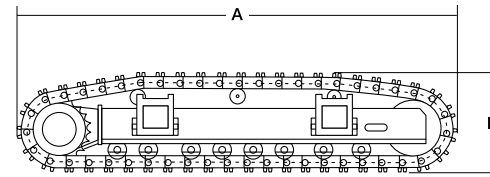

Boom

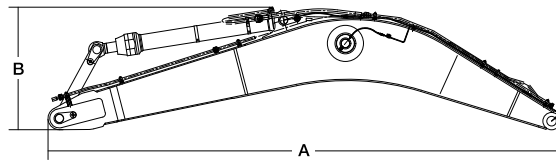

Arm

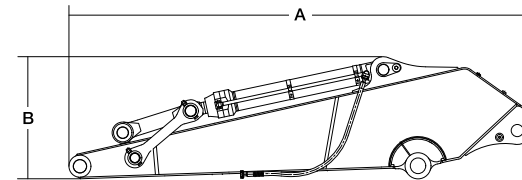

Cylinder

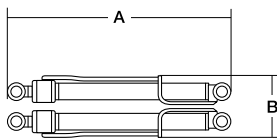

Counter weight

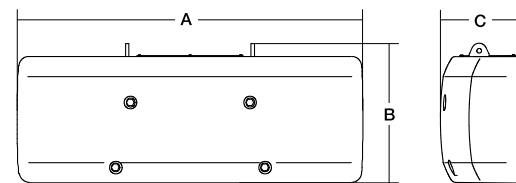

Upperstructure

Model	SH700LHD-5B	SH800LHD-5B
Weight	22 800 kg	25 200 kg
A	5 600 mm	5 880 mm
B	2 770 mm	2 800 mm
C	2 920 mm	2 950 mm
Width	3 500 mm	3 530 mm

Side lower frame

Model	SH700LHD-5B		SH800LHD-5B	
Shoe	650 mm	750 mm	650 mm	750 mm
Weight	10 140 kg	10 450 kg	12 550 kg	12 930 kg
A	5 880 mm	5 880 mm	6 360 mm	6 360 mm
B	1 340 mm	1 340 mm	1 500 mm	1 500 mm
Width	910 mm	910 mm	1 010 mm	1 010 mm

Boom

Model	SH700LHD-5B (Mass)	SH800LHD-5B (Mass)
Boom length	7.7 m(6.58 mm)	8.4 m(7.25 mm)
Weight	6 600 kg(6 250 kg)	8 290 kg(7 850 kg)
A	8 030 mm(6 910 mm)	8 750 mm(7 580 mm)
B	2 010 mm(2 490 mm)	2 310 mm(2 580 mm)
Width	1 310 mm(1 310 mm)	1 490 mm(1 490 mm)

Arm

Model	SH700LHD-5B (Mass)	SH800LHD-5B (Mass)
Arm length	3.55 m(3.0 mm)	3.66 m(2.98 mm)
Weight	3 510 kg(3 550 kg)	4 170 kg(4 250 kg)
A	4 930 mm(4 270 mm)	5 190 mm(4 380 mm)
B	1 340 mm(1 400 mm)	1 390 mm(1 500 mm)
Width	870 mm(870 mm)	960 mm(960 mm)

Boom cylinder x 2

Model	SH700LHD-5B	SH800LHD-5B
Weight	1 400 kg	1 600 kg
A	2 760 mm	2 930 mm
B	850 mm	1 000 mm
Height	730 mm	670 mm

Counter weight

Model	SH700LHD-5B	SH800LHD-5B
Weight	10 500 kg	12 500 kg
A	3 390 mm	3 470 mm
B	1 390 mm	1 390 mm
C	764 mm	825 mm

Catwalk

Model	SH700LHD-5B		SH800LHD-5B	
Arm length	Cab side	Except cab side	Cab side	Except cab side
Weight	13 kg	24 kg x 4	13 kg	23 kg x 4
Length	930 mm	1 835 mm	1 060 mm	1 290 mm
Height	140 mm		140 mm	
Width	350 mm		400 mm	

Head guard (OPG level 2)

Model	SH700LHD-5B	SH800LHD-5B
Weight	230 kg	230 kg
Length	2 310 mm	2 310 mm
Height	1 850 mm	1 850 mm
Width	1 030 mm	1 030 mm

Bucket

Model	SH700LHD-5B				SH700LHD-5B Mass	Model	SH800LHD-5B				SH800LHD-5B Mass					
Bucket capacity (ISO/SAE/PCSA heaped)	2.0 m³	2.3 m³	2.9 m³	4.0 m³	4.2 m³	Bucket capacity (ISO/SAE/PCSA heaped)	2.4 m³	3.0 m³	3.3 m³	4.1 m³	5.0 m³					
Bucket capacity (CECE heaped)	1.8 m³	2.0 m³	2.6 m³	3.5 m³	3.5 m³	Bucket capacity (CECE heaped)	2.2 m³	2.7 m³	2.9 m³	3.6 m³	3.6 m³					
Bucket type	HD				HD	Bucket type	HD				STD					
Number of teeth	4				5	Number of teeth	4				6					
Width unit:mm	With side cutter	1 405	1 555	1 850	2 050	2 140	Width unit:mm	With side cutter	1 455	1 720	1 840	2 350	2 454			
	Without side cutter	1 405	1 555	1 850	2 050	2 140		Without side cutter	1 390	1 650	1 770	2 280	2 265			
Weight unit:kg	2 430					2 650	2 850					3 280	4 340			
	3.00 m arm	●	●	●	△	○	Weight unit:kg	2 550					2 860	2 960	3 420	3 970
3.55 m arm	●	●	○	△	—	Combination		2 98 m arm					—	—	—	○
4.11 m arm	●	○	○	×	—		Combination	3.66 m arm					●	●	○	○
5.00 m arm	○	○	△	×	—	Combination		4.44 m arm					●	○	○	△
							Combination	5.62 m arm					○	△	△	×

○ Standard bucket (Suitable for materials with density up to 1,800 kg/m³ or less)
 ● Suitable for materials with density up to 2,000 kg/m³ or less
 ○ Suitable for materials with density up to 1,600 kg/m³ or less
 △ Suitable for materials with density up to 1,200 kg/m³ or less

○ Standard bucket (Suitable for materials with density up to 1,800 kg/m³ or less)
 ● Suitable for materials with density up to 2,000 kg/m³ or less
 ○ Suitable for materials with density up to 1,600 kg/m³ or less
 △ Suitable for materials with density up to 1,200 kg/m³ or less

Standard equipment

[Hydraulic system]

- SIH:S hydraulic system
- Selectable operation mode (SP mode, H mode, and A mode)
- Auto/one-touch idling
- Automatic 2-speed traveling
- Automatic power boost
- Arm/boom natural lowering prevention valve
- Arm/boom reactivation circuit
- Swing brake system
- Swing ABS
- Auxiliary valve
- Hydraulic drive cooling fan
- High-performance return filter

[Safety equipment]

- Rearview mirror (left/right)
- Emergency exit
- Seat belt
- Gate lock lever
- Traveling alarm
- Anti-theft alarm system
- Engine room fire wall
- Fan guard
- Engine emergency stop switch
- Megavolume horn

[Cab/interior equipment]

- Tilting console mechanism
- Automatic air conditioner
- Defroster
- Hot & cool box
- KAB operator's seat
- Seat suspension
- Rise-up wiper (with intermittent operation function)
- Cup holder
- AM/FM radio
- Clock
- Magazine rack
- Accessory case
- Floor mat
- Armrest & headrest
- Ashtray & cigar lighter
- Room light
- Coat hook
- Short lever

[Others]

- EMS
- Long-life hydraulic oil
- Track guard-Double track guard
- Five lights (on the main unit, atop the cab, and at right/left of arm)
- Two fuel filters (with water separator)
- Fuel prefilter (with water separator)
- Double-element air cleaner
- Pre-cleaner
- Large tool box
- A set of tools

Accessories (option)

- 12V power (DC-DC converter)
- Full track guard
- Rain reflector
- Refuel pump
- Hose burst check valve for arm/boom cylinder
- Polycarbonate with sunshade roof top window
- Front guard
- Lower window guard
- Head guard (OPG level 2)
- Air suspension (KAB seat)