

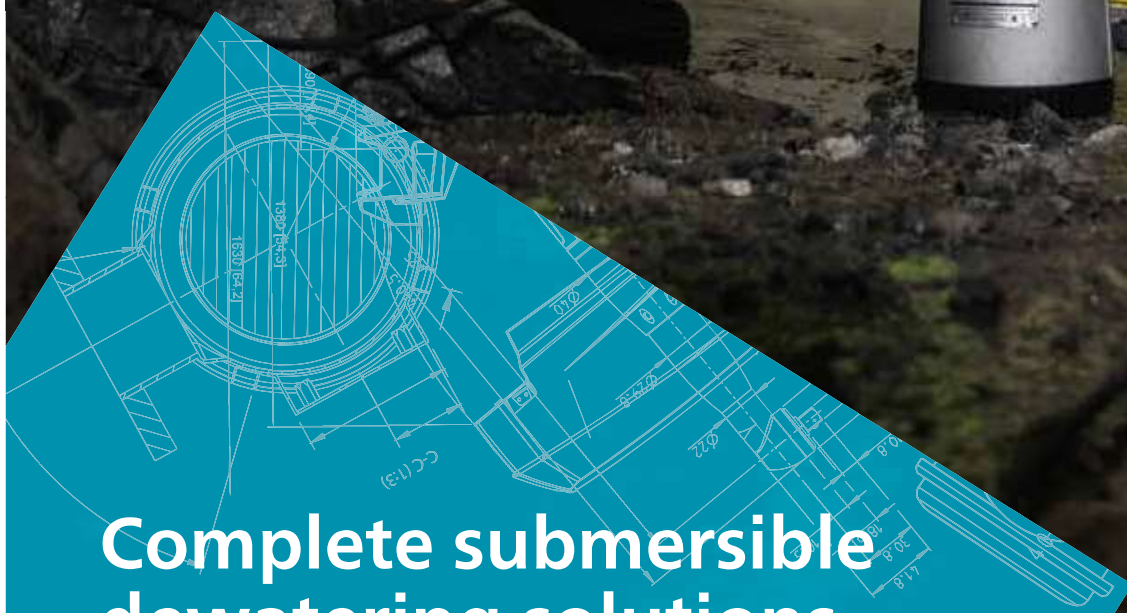

Atlas Copco



Complete submersible dewatering solutions

The WEDA pump range (50Hz)

WEDA Submersible pumps

WEDA electric submersible pumps and accessories are designed for an extensive range of dewatering applications, across multiple industries.

They provide the performance, reliability and ease of use you need. WEDA pumps feature a built-in starter and motor protection system along with optional automatic level control. Starting with the WEDA D70 in 2021, more and more WEDA pump models are updated with patented Wear Deflector Technology that provides state-of-the-art wear resistance as well as quick readjustment to as-new performance.

At Atlas Copco, we understand pumps, their applications and, most importantly, the people using them. We have a complete

range of high-quality and lightweight electric submersible pumps designed specifically for drainage, sludge and slurry pumping applications.

WEDA pumps are made for durability. The unique sealing system and modular design make them among the most flexible pumps on the market. Easy to use and maintain, WEDA pumps promise optimal performance. The WEDA seal system is designed to provide the optimum maintenance solution and can be easily fitted at the job site. Repairability of our products is built-in right from the design stage. This minimizes down-time and reduces environmental footprint, a testament to our pledge to sustainability.



**SPECIFIC
GRAVITY
UP TO 1.6**



**SOLIDS
HANDLING
UP TO 60 mm**



**UP TO
40%
LIGHTER
IN WEIGHT**



**HIGH WEAR
RESISTANCE**





There is a WEDA pump for any dewatering application

We understand the dewatering needs of our customers, which vary with location and application. Accordingly our submersible range is developed for drainage (D), sludge (S) and slurry (L) applications.

DRAINAGE PUMPS (WEDA D)



SLUDGE PUMPS (WEDA S)



SLURRY PUMPS (WEDA L)



SPECIFIC GRAVITY
UP TO 1.1

SPECIFIC GRAVITY
UP TO 1.2

SPECIFIC GRAVITY
UP TO 1.6

SOLIDS HANDLING
UP TO 12 mm

SOLIDS HANDLING
UP TO 50 mm

SOLIDS HANDLING
UP TO 60 mm

pH VALUES
FROM 5 TO 8

pH VALUES
FROM 5 TO 8

pH VALUES
FROM 2 UP TO 10



DESIGNED FOR REPAIRABILITY

Applications:

- General dewatering
- Ground water
- Raw water
- Construction sites
- Sludge or light slurry
- Tank clean-out
- Trench and pond cleaning
- Mining
- Water containing mud
- Abrasive media with solids content
- Quarries
- Dredging
- Settling ponds

WEDA D range

The WEDA drainage pumps handle clean as well as dirty water, with small solids with the best performance and efficiency.



BUILT-IN STARTER AND PROTECTION

- Rotation control
- Phase failure protection
- Thermal switches
- Direct-on-line or reduced start current with Softstarter
- Eliminates the need for external starter

FLEXIBILITY

Discharges can be mounted vertically or horizontally as required

HIGH CORROSION RESISTANCE

Unique aluminum alloy offers the perfect combination of strength, light weight and corrosion resistance

MOTOR PROTECTION

Class H motors, with thermal switches in each winding

EXTENDED PERFORMANCE

Pump design ensures all-round motor cooling for better performance and dry-running capability

CABLE SEALING

Ensures protection against water leakage from cable entry

SEALING SOLUTION

The sealing system is optimized for pump size

IMPROVED WEAR RESISTANCE

High-chrome (55HRC) impellers provide higher wear resistance

55  HRC

**Some features and options on selected models only.*

WEDA S range

The WEDA sludge pumps can handle thick, soft, wet mud or other similarly viscous mixtures of liquids and solids, especially the product of an industrial or refining process.

DRY RUNNING CAPABILITIES

Improved rib design offers external cooling to motor for extended running time

MOTOR PROTECTION

Class H motors, with thermal switches in each winding

SOLIDS HANDLING

Sludge pumps can handle solids up to 50 mm

 **SOLIDS HANDLING**
UP TO 50_{mm}

ROBUST DESIGN

Base of the pump ensures stability while enabling passage of large solids

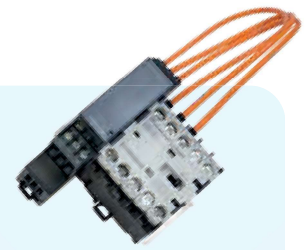
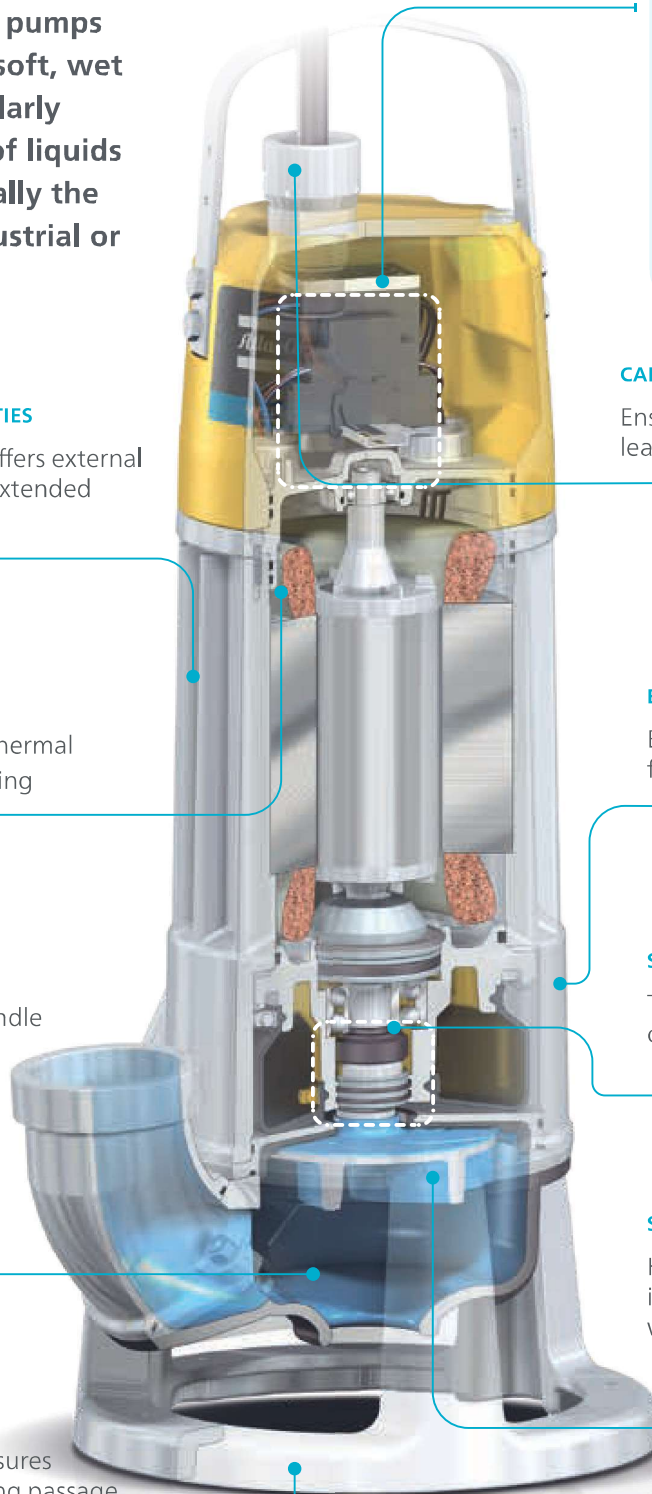

BUILT-IN STARTER AND PROTECTION

- Rotation control
- Phase failure protection
- Thermal switches
- Phase shifter plugs for three-phase pumps
- Eliminates the need for external starter

CABLE SEALING

Ensures protection against water leakage from cable entry

EASY INSPECTION

External oil inspection plug for quick inspection of oil

SEALING SOLUTION

The sealing system is optimized for pump size

SUSTAINABLE PERFORMANCE

High-chrome (55HRC) impellers provide higher wear resistance

55  HRC

**Some features and options on selected models only.*

WEDA L range

The WEDA slurry pumps are the toughest, to facilitate handling of slurry with the most challenging solids.

ROBUST DESIGN

Heavy duty bearings to withstand shocks and overloads

HEAVY-DUTY MOTOR

Electric motor insulation class H with thermal contacts for overload protection

HIGH ABRASION RESISTANCE

Thanks to the high-chrome wear parts

REINFORCED SEALING

A double silicon carbide mechanical seal for heavy-duty application

SOLIDS HANDLING

Slurry pumps can handle solids up to 60 mm



SUSTAINABLE PERFORMANCE

High efficiency high chrome agitator to lift settled solids

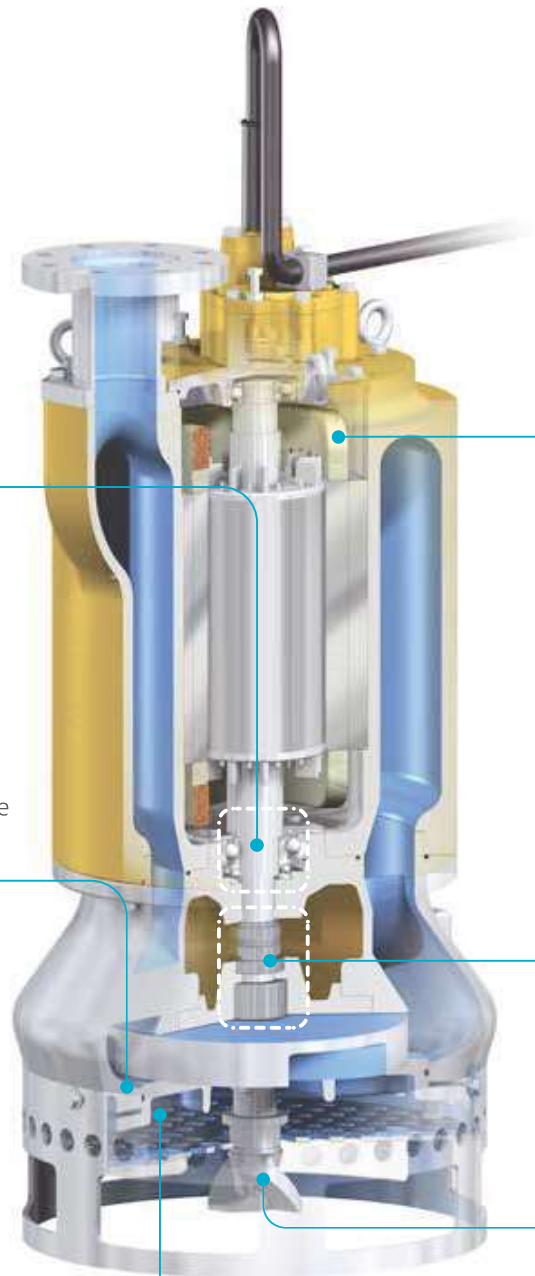

**Some features and options on selected models only.*



Tough environments demand tough pumps

The unique construction of the WEDA pumps provides high corrosion and wear resistance in a wide range of applications

WEDA D range

Technical data



		WEDA D04N	WEDA D04BN	WEDA D08N	WEDA D10N		WEDA D30L		WEDA D30N		WEDA D40N
SPECIFICATIONS		1ph	1ph	1ph	1ph	3ph	1ph	3ph	1ph	3ph	3ph
Max. head	m	11.3	12.0	14.8	14.5	14.5	15.5	15.0	23	22	20
Max. flow	l/min	250	120	325	490	490	1450	1425	820	810	1600
	m ³ /h	15	7.2	20	30	30	85	85	50	50	95
Shaft speed	r.p.m.	2900	2900	2900	2900	2900	2900	2900	2900	2900	2900
Rated output	kW	0.4	0.4	0.75	1.0	1.0	2.0	2.0	2.0	2.0	3.0
Max. power input	kW	0.65	0.65	1.2	1.6	1.3	2.6	2.6	2.6	2.6	3.6
Discharge connection	inch	2"	1"	2"	2"	2"	3"	3"	3"	3"	3"
Max. solids handling size	mm	7.5	4.5	7.5	4	4	7	7	7	7	7
WEIGHT & DIMENSIONS											
Weight	kg	9.0	9.5	12.4	13.0	13.0	20	20	20	20	25
Height	mm	340	415	358	470	470	525	525	525	525	525
Width	mm	182	220	183	225	225	290	290	290	290	290
Diameter	mm	182	220	183	185	185	220	220	220	220	220

Typical applications

- General construction
- Ground water
- Raw water
- Construction sites





Performance curves

WEDA D04N

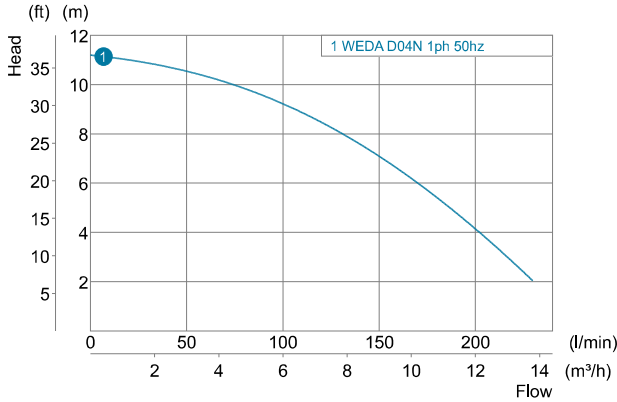

WEDA D04BN

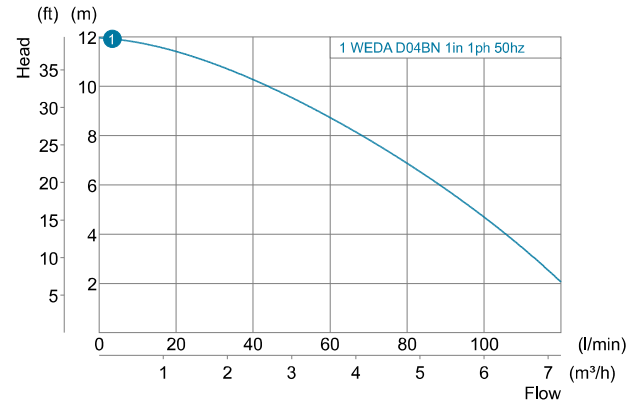

WEDA D08N

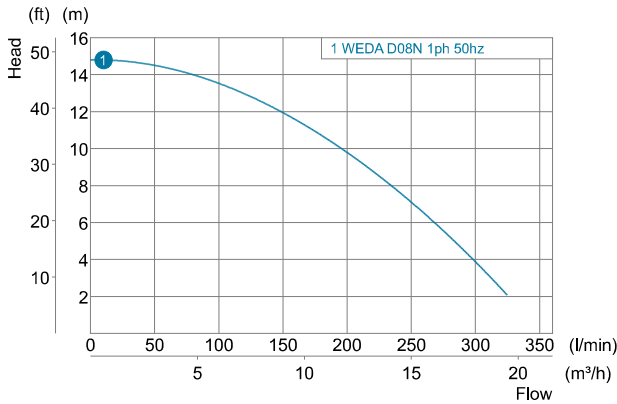

WEDA D10N

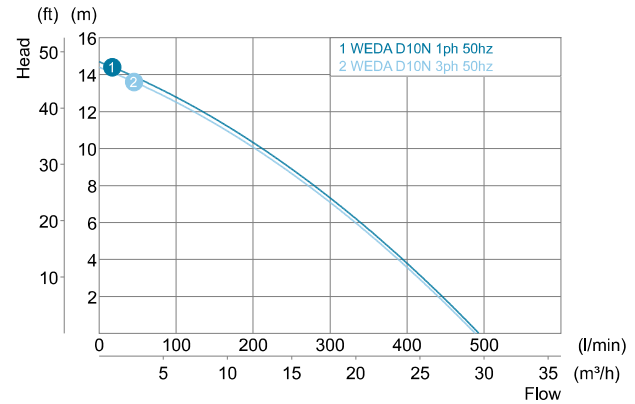

WEDA D30

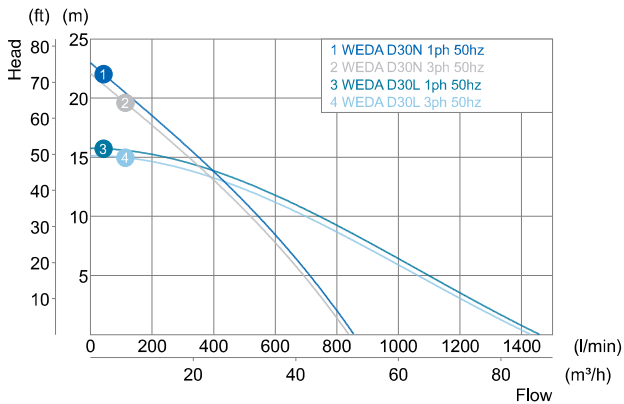

WEDA D40N

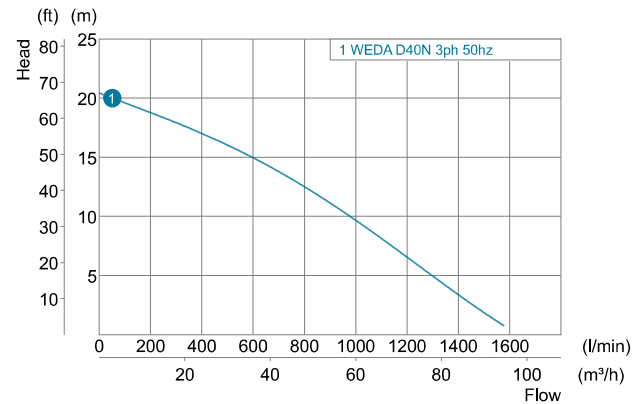

WEDA D range

Technical data



		WEDA D50N	WEDA D50H	WEDA D60N	WEDA D60H	WEDA D60SH	WEDA D70L	WEDA D70H
SPECIFICATIONS		3ph	3ph	3ph	3ph	3ph	3ph	3ph
Max. head	m	24	38	28	38	59	37	57
Max. flow	l/min	2300	1150	2600	1500	1050	4600	2500
	m ³ /h	135	70	155	90	60	275	150
Shaft speed	r.p.m.	2900	2900	2900	2900	2900	2900	2900
Rated output	kW	5.6	5.6	7.5	7.5	7.5	12	12
Max. power input	kW	6.7	6.7	8.8	8.8	8.8	13.8	13.8
Discharge connection	inch	4"	3"	4"	3"	3"	6"	4"
Max. solids handling size	mm	8	8	8	8	8	10	10
WEIGHT & DIMENSIONS								
Weight	kg	55	55	61	61	62	110	110
Height	mm	720	720	760	760	760	943	943
Width	mm	330	302	330	302	302	416	393
Diameter	mm	278	278	278	278	278	370	370

Typical applications

- General construction
- Ground water
- Raw water
- Construction sites





Performance curves

WEDA D50

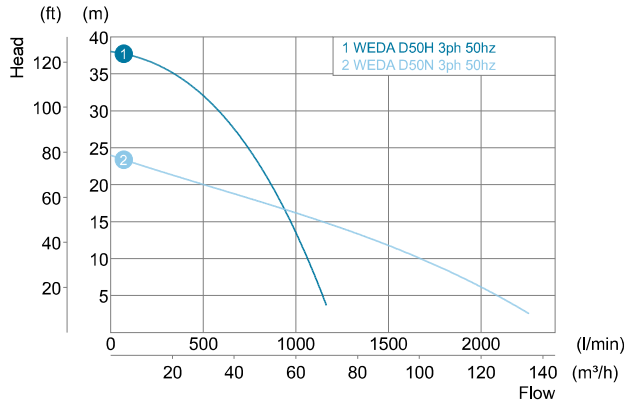

WEDA D60

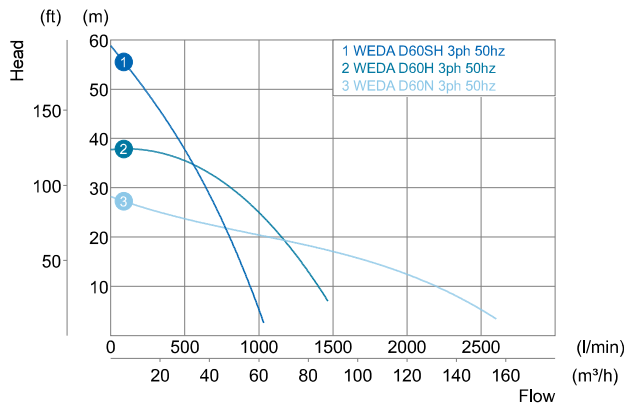

WEDA D70

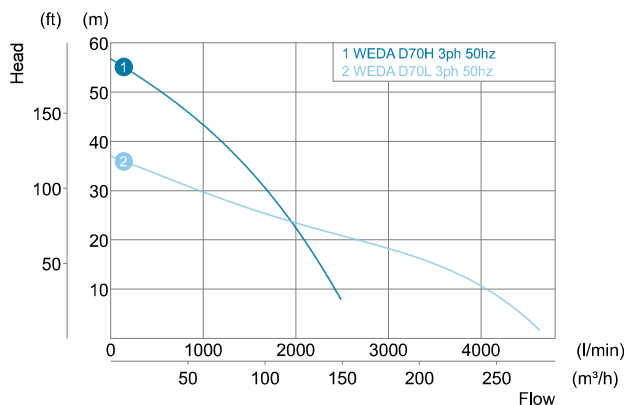

Wear Deflector Technology

WEDA submersible drainage pumps are equipped with a revolutionary hydraulic design that minimizes wear and keeps performance up, even under the toughest conditions.

The patented Wear Deflector Technology consists of several aspects that combine to provide unrivaled resistance to wear by abrasive particles in the pumped media:

- Developed with state-of-the-art Computational Fluid Dynamics (CFD)
- 3D printing to cast complex geometries
- High chrome wear resistant impeller
- Closed impeller with auxiliary vanes to keep the impeller eye free from abrasives
- Lower diffuser with wear deflector vanes to avoid impeller inlet wear

	D70L	D70H	D80N	D80H	D95N	D95H
State-of-the-art hydraulic design techniques	✓	✓	✓	✓	✓	✓
State-of-the-art manufacturing techniques	✓	✓	✓	✓	✓	✓
High chrome wear resistant impeller	✓	✓	✓	✓	✓	✓
Closed impeller with auxiliary vanes		✓		✓		✓
Lower difuser with wear deflector vanes		✓				



WEDA D range

Technical data



		WEDA D80N	WEDA D80H	WEDA D90L	WEDA D90H	WEDA D95N	WEDA D95H	WEDA D100N
SPECIFICATIONS		3ph	3ph	3ph	3ph	3ph	3ph	3ph
Max. head	m	40	65	44	86	31	86	43
Max. flow	l/min	6000	2500	6800	2400	11000	4000	18000
	m ³ /h	360	150	400	145	660	240	1080
Shaft speed	r.p.m.	2900	2900	2900	2900	2900	2900	1450
Rated output	kW	20	20	27	27	37	37	60
Max. power input	kW	22	22	30	30	43	43	65
Discharge connection	inch	6"	4"	6"	4"	8"	4"	10"
Max. solids handling size	mm	12	12	7	7	16	12	12
WEIGHT & DIMENSIONS								
Weight	kg	175	175	180	180	265	265	510
Height	mm	980	980	1100	1100	1330	1330	1412
Width	mm	690	665	480	480	460	460	650
Diameter	mm	530	530	400	400	460	460	600

Typical applications

- General construction
- Ground water
- Raw water
- Construction sites





Performance curves

WEDA D80

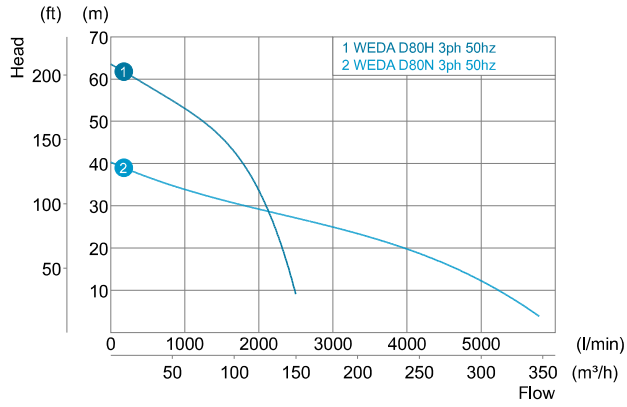

WEDA D90

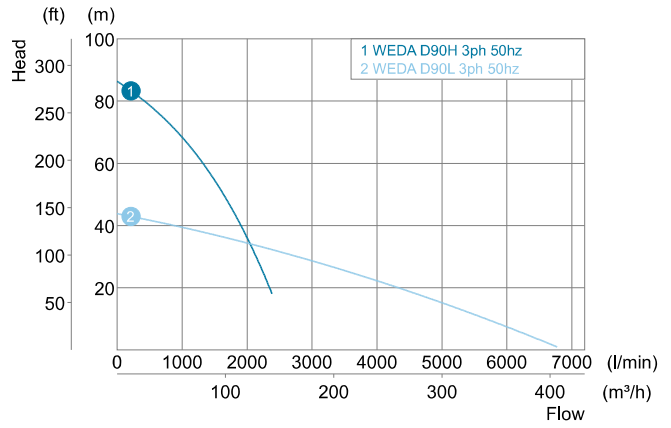

WEDA D95

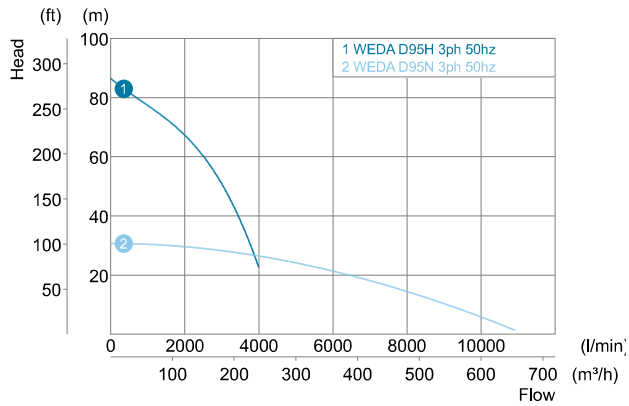

WEDA D100

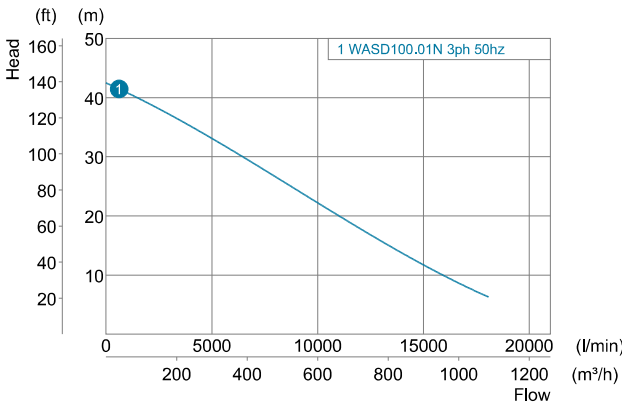

WEDA S range

Technical data



		WEDA S04N	WEDA S08N	WEDA S30N		WEDA S50N	WEDA S60N
SPECIFICATIONS		1ph	1ph	1ph	3ph	3ph	3ph
Max. head	m	10.5	13	13	15	23	25
Max. flow	l/min	270	320	800	950	1450	1750
	m ³ /h	16	19	48	57	87	105
Shaft speed	r.p.m.	2900	2900	2900	2900	2900	2900
Rated output	kW	0.4	0.75	1.8	2.5	4.8	6.9
Max. power input	kW	0.65	1.2	2.4	3	5.7	8.1
Discharge connection	inch	2"	2"	3"	3"	4"	4"
Max. solids handling size	mm	25	25	50	50	50	50
WEIGHT & DIMENSIONS							
Weight	kg	11	13	25	25	59	65
Height	mm	375	416	620	620	810	870
Width	mm	277	277	326	326	450	450
Diameter	mm	241	241	250	250	350	350

Typical applications

- Sludge or light slurry
- Tank clean-out
- Trench and pond cleaning
- Mining





Performance curves

WEDA S04N

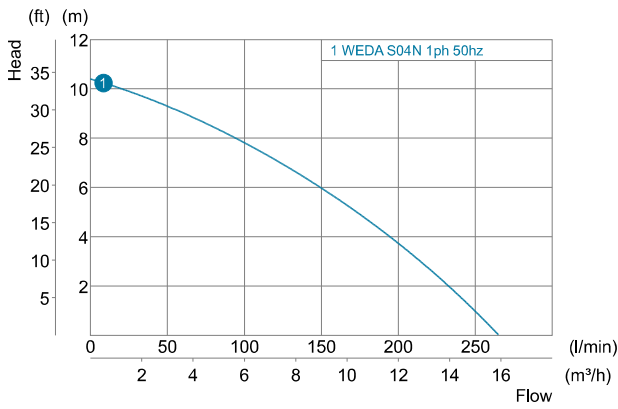

WEDA S08N

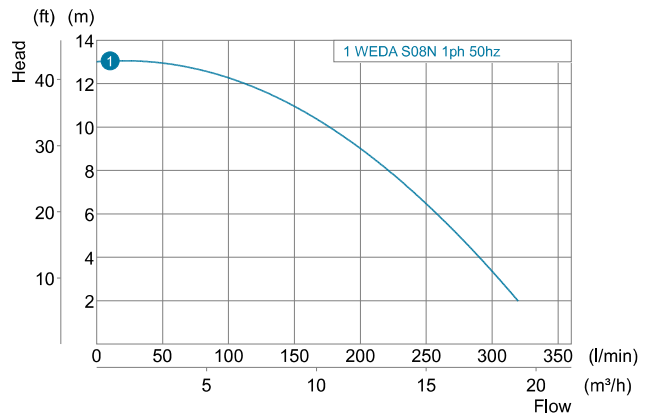

WEDA S30N

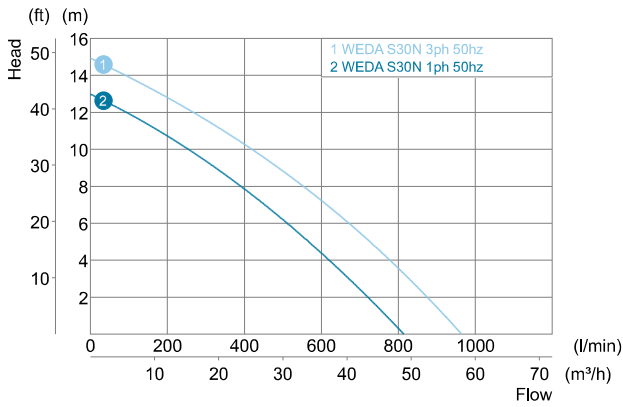

WEDA S50N

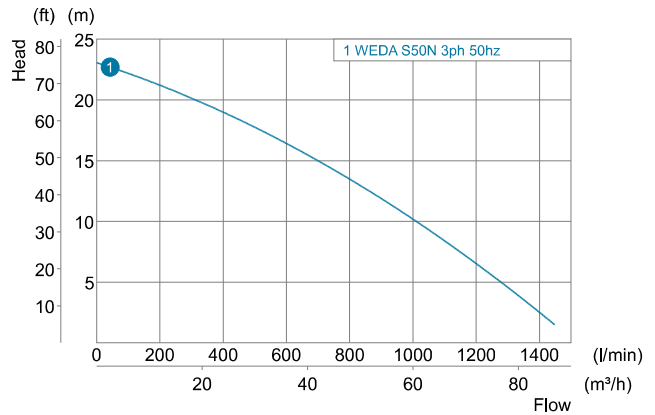

WEDA S60N

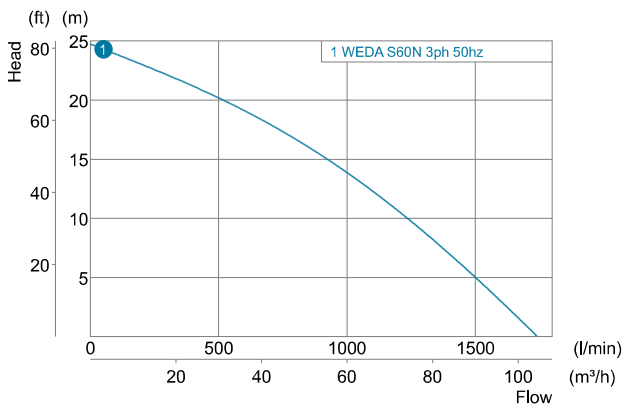

WEDA L range

Technical data



		WEDA L40N	WEDA L50N	WEDA L60N	WEDA L70N	WEDA L80N	WEDA L95N	WEDA L100N	WEDA L110N
SPECIFICATIONS		3ph	3ph	3ph	3ph	3ph	3ph	3ph	3ph
Max. head	m	13	17	23	24	26	47	30	43
Max. flow	l/min	1150	1700	1050	1500	3300	4750	11000	12500
	m ³ /h	69	102	63	90	198	285	660	750
Shaft speed	r.p.m.	1450	1450	1450	1450	1450	1450	980	1450
Rated output	kW	3.7	5.5	9.0	11.0	15.0	37	45	75
Max. power input	kW	4.5	6.8	10.4	12.8	16.1	40	49	80
Discharge connection	inch	3"	4"	4"	4"	4"	4"	6"	6"
Max. solids handling size	mm	20	25	25	25	25	35	60	60
WEIGHT & DIMENSIONS									
Weight	kg	185	260	260	270	310	750	1005	1070
Height	mm	793	914	914	914	1080	1605	1605	1605
Width	mm	388	435	435	435	580	935	935	935
Diameter	mm	337	413	413	413	495	546	546	546

Typical applications

- Abrasive media with high solids content
- Quarries
- Dredging
- Settling ponds





Performance curves

WEDA L40N

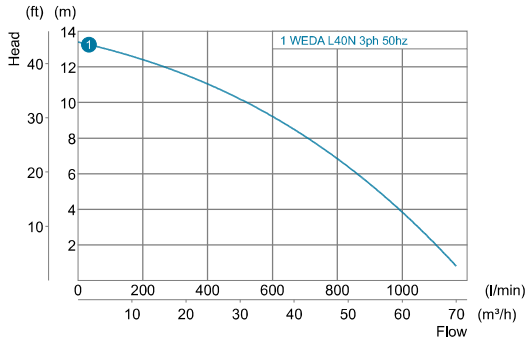

WEDA L50N

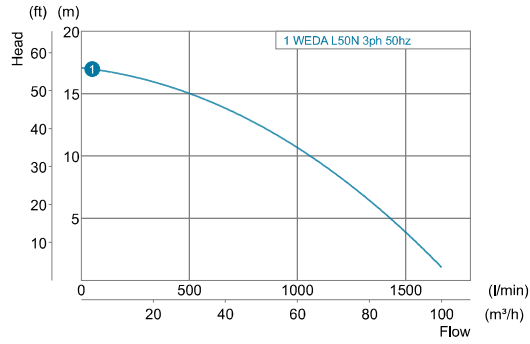

WEDA L60N

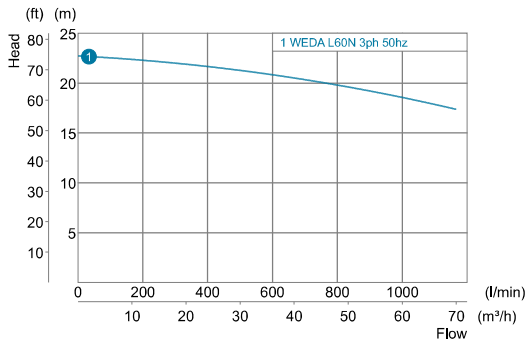

WEDA L70N

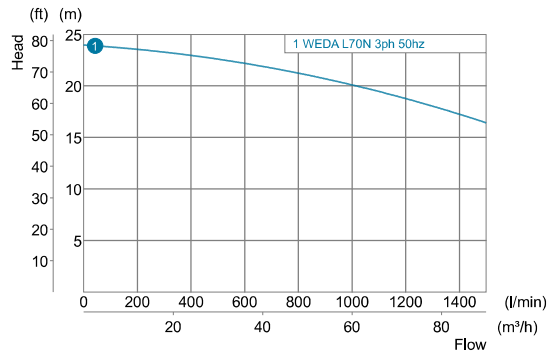

WEDA L80N

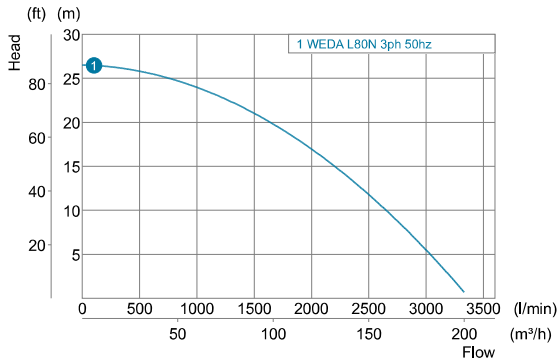

WEDA L95N

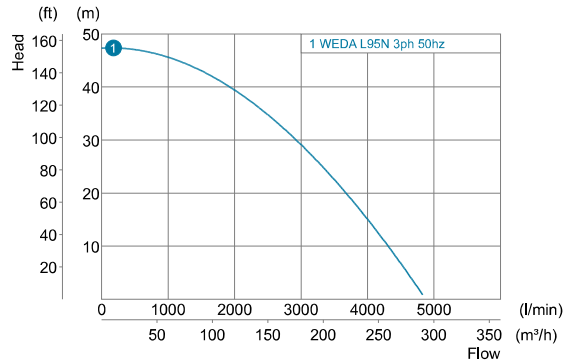

WEDA L100N

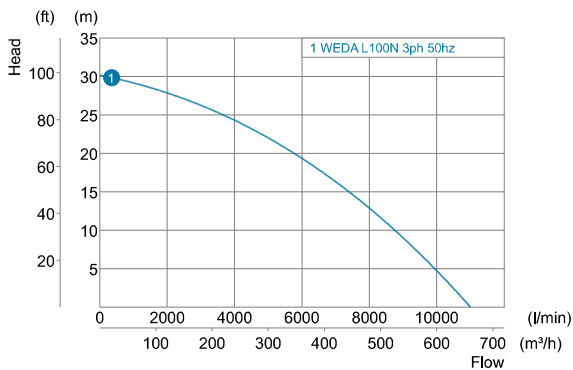

WEDA L110N

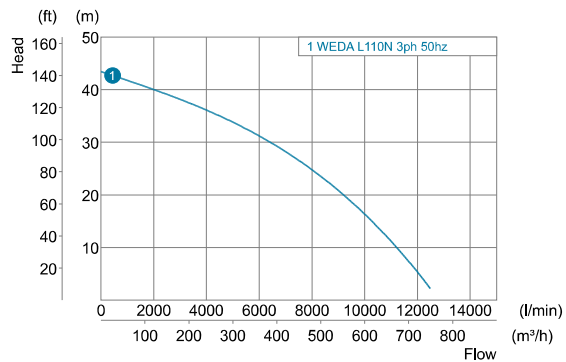

Accessories

DISCHARGE CONNECTIONS

We understand that you will have preferred equipment connections, so we offer four types. All can be mounted in either a vertical or horizontal position.



Hose



Storz



ISO-G



NPT

SLIM ADAPTER

For lowering pumps in narrow pipes and manholes.



LEVEL REGULATORS

For easy control of water level by automatic pump switch-on/-off:



LOW SUCTION COLLAR

To easily drain the water level down to the floor.

RAFT

For easy floatation of pump with fluctuating water levels. Strainer option available.



ZINC ANODES

Specifically required for pumping water with a high concentration of salts such as seawater, brine, etc.



Service Kits

SEAL KIT

The seal kit is the proper selection of high quality components for a mechanical seal change to ensure trouble-free operation after servicing.

- O-ring kit
- Mechanical shaft seal



INSTANT SERVICE PACK

The instant service pack is a preassembled, tested and ready-to-use seal system containing the mechanical shaft seals, bearings, gaskets and oil to ensure trouble-free operation. It offers a quick onsite repair option due to ease of installation and therefore reduces the machine downtime cost.



WEAR PART KIT

The wear part kit is a typical selection of components to bring the pump performance back to factory standard. The ideal solution for a machine overhaul or refurbishment.

- Impeller
- Wear plate
- Diffuser

**Some features and options on selected models only.*

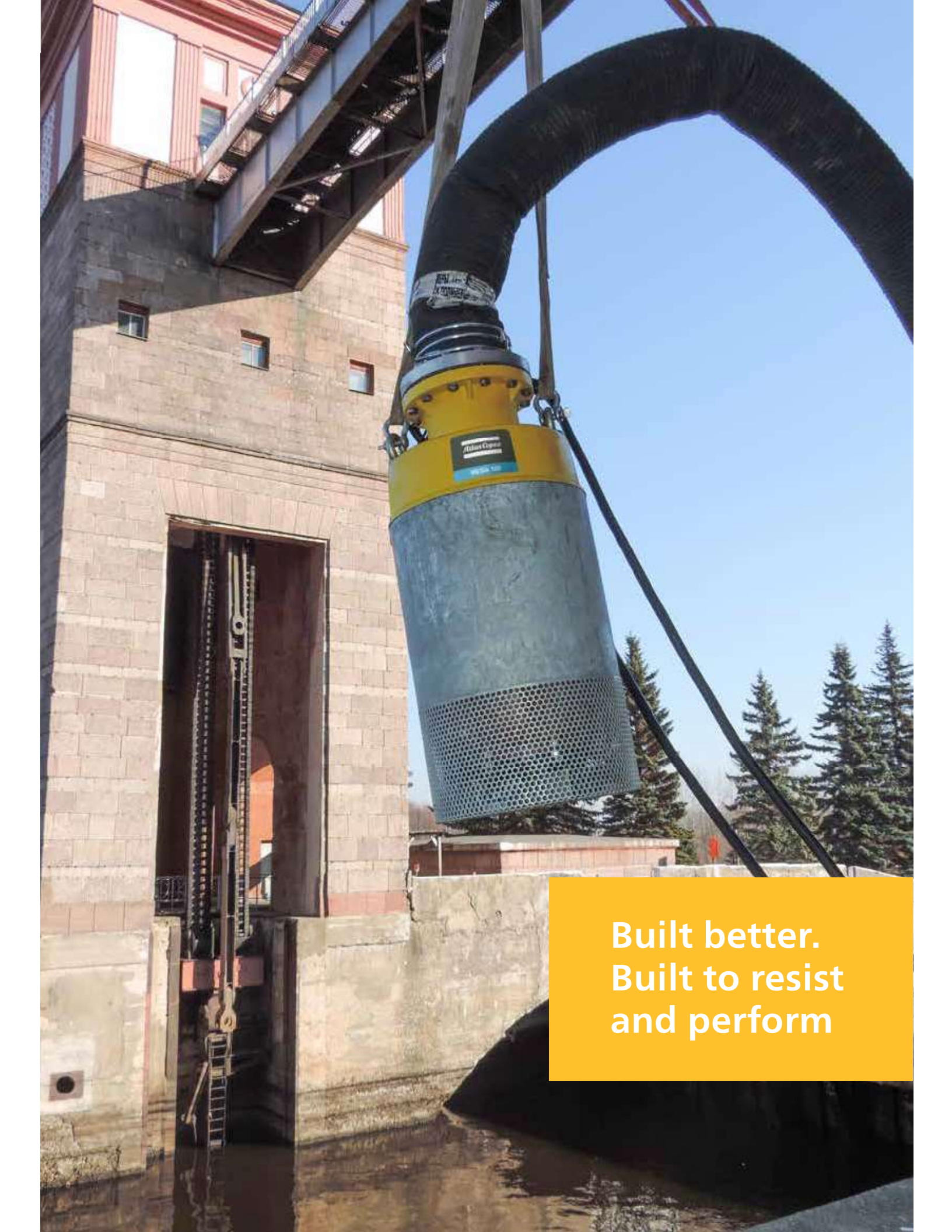

**Built better.
Built to resist
and perform**

Product portfolio

GENERATORS

<p>PORTABLE 1,6–12 kVA</p>  <p>StageV</p>	<p>SPECIALIZED 9–660* kVA</p>  <p>StageV</p>	<p>VERSATILE 9–1250* kVA</p> 	<p>LARGE POWER 800–1450 kVA</p>  <p>StageV</p>
---	--	--	--

*Multiple configurations available to produce power for any size application

DEWATERING PUMPS







<p>ELECTRIC SUBMERSIBLE up to 18 000 l/min</p>  	<p>SURFACE PUMPS 833–23.300 l/min</p>  <p>StageV</p>	<p>ZENERGIZE 45–500* kVA</p>  
---	--	---

Diesel and electric options available

LIGHT TOWERS

<p>DIESEL</p>  <p>StageV</p>	<p>BATTERY</p>  	<p>ELECTRIC</p>  
---	--	---

ONLINE SOLUTIONS

<p>SHOP ONLINE PARTS ONLINE</p> <p>Spare parts for power equipment. We handle your orders 24 hours a day.</p> 	<p>POWER CONNECT</p> <p>Scan the QR code on your machine, and go to the QR Connect Portal to find all the information about your machine.</p> 	<p>LIGHT THE POWER: YOUR SIZING TOOL</p> <p>A useful calculator to help you choose the best solution for your power and light needs.</p> 
<p>FLEETLINK</p> <p>Intelligent telematics is a system that helps optimize fleet usage and reduce maintenance, ultimately saving time and cutting operating costs.</p> 	<p>PUMP SIZING CALCULATOR</p> <p>With a few inputs, this pump sizing calculator will help you to compare dewatering submersible models and find the right one for you.</p> 	<p>VISIT THE POWER ISLAND</p> <p>Live a 360° experience to discover a selection of products and solutions that we offer, in an almost real environment.</p> 

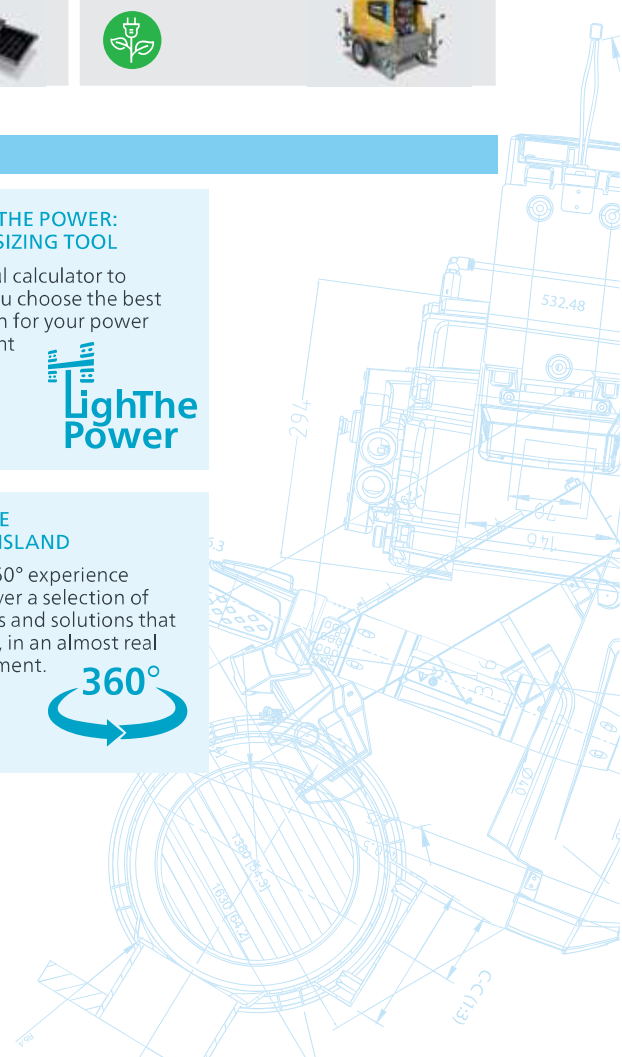

WEDA D70 (50 Hz)

Product reference sheet

The WEDA drainage pumps handle either clean or sand-laden water, even with small solid particles, with the best performance and efficiency. These pumps are designed with robustness, sustained performance and ease-of-maintenance in mind. Suitable for general dewatering applications, ground water, raw water, construction sites and harsh conditions on site.

Product code	WEDA D70
Installation	Portable drainage pump
Hydraulic range	L - high flow H - high head
Insulation class	H (+180°C/+356°F) IEC 85 (VFD-ready)
Protection class	IP68
Voltage variation	Max ± 5% of nominal voltage
Voltage imbalance	Max 2% - between phases
Max start-stop	Max 30 starts/hour
Cable	H07RN-F (20 m) or SOOW AWG (65 ft)
Casted parts	Corrosion resistant aluminum
Impeller	High chrome iron, 55±5 HRC
Wear parts	Rubber (NBR)
Diffuser	Polyurethane
Strainer	Corrosion resistant aluminum
Shaft	Stainless steel
O-rings	Rubber (NBR)
Main bearing	Double row ball bearing, pre-greased
Mechanical seal	Cartridge-type, primary + secondary: SiC/SiC
Built-in controls and protection	contactor + control relay + overload relay
Thermal contacts	140°C / 284°F
Options / accessories	Float switch Zinc anodes Epoxy coating Quick couplings (hose / NPT / ISO-G / Camlock / Storz) Pump raft Terminal board Softstarter NSSHÖU screened cable

Product code	WEDA D70
Solid handling, strainer hole	10 mm
Liquid temperature	Max 40°C
Depth of immersion	Max 20 m
Max liquid specific gravity	1.1
pH of the pumped liquid	pH 5–8

Weight and dimensions	L - High flow	H - High head
Discharge connection	6" (150 mm)	4" (100mm)
Height	943 mm	943 mm
Width	415 mm	393 mm
Diameter	370 mm	370 mm
Weight (excl. cable)	110 kg	110 kg

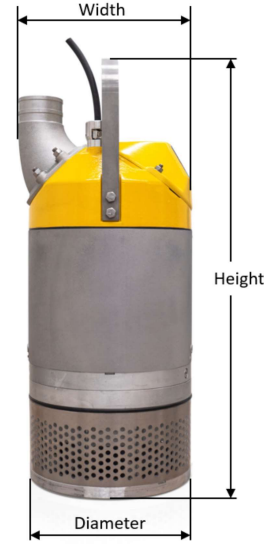

Performance curve

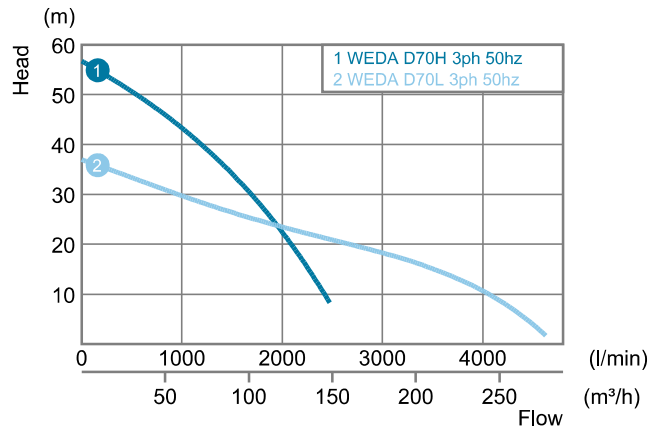

Power rating

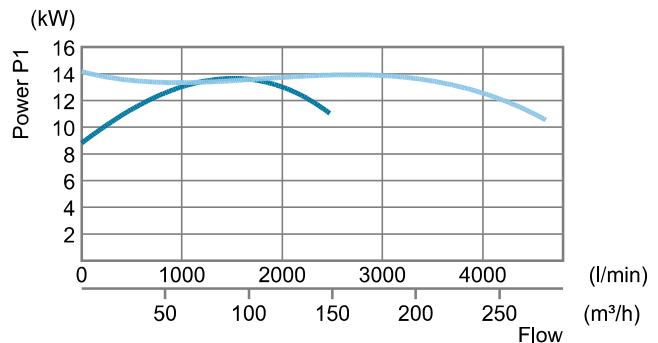

Rating	3 ph	Std cable
Power P ₁	13.8 kW	
Power P ₂	12 kW	
Shaft speed	2900 r.p.m.	
400 V	23 A	4mm ²
500 V	18.7 A	2.5mm ²
690 V	13.6 A	2.5mm ²
1000 V	9.4 A	2.5mm ²

Other voltages on request

SOFTSTARTER (50 Hz)

Product reference sheet

Some applications require pumps to be started with start-current reduction, reducing stress on the power supply and avoiding brown-outs that can harm the pump or other equipment on the same supply.



Until a few years ago the most cost-effective start-current reduction was using a Star-Delta starter which reduces the motors inrush current but faces other inconveniences such as additional components, more complicated cabling, to name but a few.

Recent years have seen great progress in the area of Softstarters which provide better start-current reduction, with fewer components at a competitive price point.

Atlas Copco Softstarter feature	Benefit
Rotation-check	The Softstarter checks the phase sequence of the incoming power supply and protects the pump from running backwards (the built-in Star-Delta starter did not include a phase sequence relay due to limited space)
Phase-presence-check	The Softstarter checks the presence of all 3 phases and will prevent the pump from starting if not all three phases are present.
Additional all-phase-trip contactor	Many competitor solutions will only trip the power supply to the pump on 2 phases, leaving 1 live phase being fed into the pump, potentially creating hazardous situations. The Atlas Copco pump with Softstarter adds an extra contactor to the starter arrangement, tripping all three phases for a safe workplace!
Overload protection	Built right into the Softstarter.
Locked-rotor protection	Built right into the Softstarter.

Atlas Copco is replacing the built-in Star-Delta starters with the Softstarter according to the availability in the table below (Star-Delta components for repair will be available as per standard spare parts availability policy).

Softstarter range	
Pump models	WEDA D60
Supply voltage 50Hz	220 - 600 V 50Hz
Supply voltage 60Hz	220 - 600 V 60Hz
Pump models	WEDA D70
	WEDA D80
Supply voltage 50Hz	220 - 600 V 50Hz
Supply voltage 60Hz	380 - 600 V 60Hz

Softstarter parameter	Pictogram	WEDA D60 WEDA D70	WEDA D80
Ramp-up		5-7 s	5-7 s
Ramp-down (not used)		10 s	10 s
Full Load Current		Pump rated current + 10%	Pump rated current + 10%

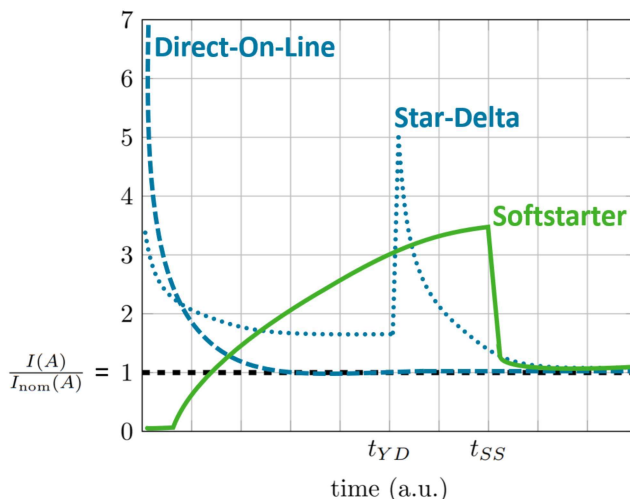

Schematic representation of two common methods for start-current reduction, Star-Delta (dotted) and Softstarter (solid green), compared with Direct-On-Line (no start current reduction, dashed).

Trouble shooting

The Softstarter incorporates a flashing red LED for error-indications, facilitating workbench trouble shooting:

No. of flashes	Fault
2	Wrong phase sequence
3	Line voltage out of range
4	Phase loss (motor side)
5	Locked rotor
7	Over temperature (Softstarter)
8	Overload
9	Supply voltage imbalance
10	Shorted thyristor
Fully on	Internal fault