

GUARDAIR®

Innovation in the air

Safety Air Guns
& Pneumatic Vacuums



guardair.com

GUARDAIR

guardair.com

About Us

With a rich history dating back to 1942, Guardair Corporation is a leading US manufacturer of best-in-class, tools and accessories for MROP (Maintenance, Repair, Operations, Production) applications. Headquartered in Chicopee, Massachusetts, the Company features three distinct brands:



Safety Air Guns feature exceptional performance including protection from chip fly-back, noise suppression, and syphon capabilities. Designed for safe, and effective cleaning, the line includes a wide-range of specialty air guns for a multitude of industrial applications. All meet OSHA Standards when cleaning with compressed air.

Pneumatic Vacuums offer significant advantages in performance, dependability, safety, and life-cycle cost over conventional electric-powered vacuums. Powered by compressed air, with no moving parts or electric motors to burn out, these powerful, versatile and low-noise vacuums are ideal for the toughest industrial environments.



Manufacturer of air excavation tools for the arbor/landscape and utility/construction markets. Featuring the original AirSpade, the Utility AirSpade, and the mobile, tire-mounted AirVac, **AirSpade** products are ideal for tree care and "soft excavation" applications.



Manufacturer of tools designed to fabricate flange gaskets. Featuring extension-style and rotary-style gasket cutters, **Allpax** product line also includes hollow punches, arch punches, and other accessories.

Associations



Guardair World Headquarters Chicopee, MA

⚠ WARNING



Eye protection must be worn at all times, eye protection to confirm to ANSI Z87.1.



Respiratory protection to be used when exposed to contaminants that exceed the application threshold limit values required by law.



Ear protection to be worn when exposure to sound exceeds the limits of applicable Federal, State or local statutes, ordinances and/or regulations.



General warning. Caution, risk of danger. Practice safety requirements. Work alert, have proper attire, and do not operate tools under the influence of alcohol or drugs.



Air line hazard, pressurized supply lines and flexible hoses can cause serious injury. Do not use damage, frayed or deteriorated air hoses and fittings.



WARNING: Cancer and Reproductive Harm – www.P65Warnings.ca.gov.

Table of Contents

SAFETY AIR GUNS

PalmJet® Series	06
Ultra® Series	08
Classic+ Series	13
ThumbSwitch Series	21
Lazer® Series	25
Big Air Guns	29
Specialty Air Guns	33
Syphon Guns	37
Safety Air Gun Accessories	41
Safety Air Gun Replacement Parts	43
Shop Accessories	47

PNEUMATIC VACUUMS

Standard Pneumatic Vacuums	50
Specialty Pneumatic Vacuums	58
Static Conductive Pneumatic Vacuums	62
Hazardous Location Pneumatic Vacuums	67
Hand-held Pneumatic Vacuums	70
Vacuum Parts & Accessories	74

HOSE & FITTINGS	84
----------------------------------	----

WARRANTIES	89
-------------------------	----

MEETING OSHA STANDARDS



At Guardair Corporation, our number one concern is worker safety. Given this focus, all Guardair safety air guns meet or exceed applicable OSHA Standards.

OSHA regulations can often be confusing. However one thing is certain. Compressed air can be extremely dangerous if misused, and horseplay in the workplace can lead to serious injury. This is why compliance with OSHA Standards pertaining to Output Pressure, Chip Guarding and Noise is critical when cleaning with compressed air.



OSHA COMPLIANCE KIT

Understand OSHA Standards when cleaning with compressed air, test air guns for OSHA compliance, and raise plant safety awareness with the Guardair **OSHA COMPLIANCE KIT**.

Complete kit includes:

- OSHA Standards
- Air Pressure Test Gauge
- AIR GUN SAFETY IN THE WORKPLACE Video
- AIR GUN SAFETY POSTER

Available **FREE** to Guardair Distributors and qualified End-Users.

Visit guardair.com to order the **OSHA COMPLIANCE KIT**, or to enroll in the **OSHA WEBINAR**.

OUTPUT PRESSURE

Factory air lines normally operate at pressures between 80 and 120 psi (pounds per square inch). Most pneumatic tools, including air guns, require such high pressures to operate effectively. However, OSHA requires that should the nozzle tip of an air gun become dead-ended (blocked), the static pressure at the point of blockage be no more than 30 psi.

All Guardair safety air guns meet this requirement.

OSHA STANDARD

29CFR Part 1910.242 (b)

Hand and portable powered tools and equipment, general.

OSHA INSTRUCTION

STD 01-13-001

OSHA PROGRAM DIRECTIVE #100-1

CHIP GUARDING

Blowing off debris with an air gun in close quarters often subjects workers to "chip fly-back". This term refers to the tendency of loose particles or chips to fly back into the operator's face, eyes or skin. For operations which require close-in work, OSHA requires that "effective chip guarding" be incorporated into the workplace.

Guardair offers safety air guns designed for close-in work incorporating a protective air cone for effective chip guarding.

OSHA STANDARD

29CFR Part 1910.242 (b)

Hand and portable powered tools and equipment, general.

OSHA INSTRUCTION

STD 01-13-001

OSHA PROGRAM DIRECTIVE #100-1

NOISE

Excessive noise generated in the workplace can be harmful. To address this problem, OSHA has developed permissible daily noise exposure specifications. The use of low noise, safety air guns can sometimes be an important component in moving towards noise compliance.

Guardair offers safety air guns which incorporate proprietary noise-limiting features.

OSHA STANDARD

29CFR Part 1910.95 (a)

Occupational noise exposure.

APPLICABLE OSHA STANDARDS

OUTPUT PRESSURE/CHIP GUARDING

OSHA STANDARD

29CFR Part 1910.242 (b)

Hand and portable powered tools and equipment, general.

Compressed air used for cleaning. Compressed air shall not be used for cleaning purposes except where reduced to less than 30 psi and then only with effective chip guarding and personal protective equipment.

OSHA INSTRUCTION

STD 01-13-001

October 30, 1978

Office of Program Operations

February 14, 1972

OSHA PROGRAM DIRECTIVE #100-1

To: National and Field Offices

Subject: Reduction of Air Pressure Below 30 psi for Cleaning Purposes

Attachment: Acceptable Methods for Complying with 41 CFR 50-204.8 and 29 CFR 1910.242(b)

- 1. Purpose.** To provide guidance and examples of what alternate systems will meet the requirements of this section, and to clarify its intent.
- 2. Background.** A number of inquiries have been received requesting a clarification of the meaning of 1910.242(b) also known as 41 CFR 50-2048 under the Walsh-Healey Act.
- 3. Interpretation.** The phrase "reduce to less than 30 psi" means that the downstream pressure of the air at the nozzle (nozzle pressure) or opening of a gun, pipe, cleaning lance, etc., used for cleaning purposes will remain at a pressure level below 30 psi for all static conditions. The requirements for dynamic flow are such that in the case when dead ending occurs a static pressure at the main orifice shall not exceed 30 psi. This requirement is necessary in order to prevent a back pressure buildup in case the nozzle is obstructed or dead ended. See enclosure (1) for two acceptable methods of meeting this requirement. Also, there is no intent to restrict the diameter of the nozzle orifice or the volume (CFM) flowing from it.

"Effective chip guarding" means any method or equipment which will prevent a chip or particle (of whatever size) from being blown into the eyes or unbroken skin of the operator or other workers. Effective chip guarding may be separate from the air nozzle as in the case where screens or barriers are used. The use of protective cone air nozzles are acceptable in general for protection of the operator but barriers, baffles or screens may be required to protect other workers if they are exposed to flying chips or particles.
- 4. Action.** Inquiries about subject section should be handled in accordance with this instruction.
- 5. Effective Date.** This instruction is effective immediately, and will remain in effect until canceled or superseded.

Director, of Program Operations

NOISE

OSHA STANDARD

29CFR Part 1910.95 (a)

Occupational noise exposure.

Protection against the effects of noise exposure shall be provided when the sound levels exceed those shown in Table G-16 when measured on the A scale of a standard sound level meter at slow response.

Table G-16 Permissible Noise Exposures

Duration per day, hours	8.0	6.0	4.0	3.0	2.0	1.5	1.0	0.5	0.25
Sound level dBA slow response	90	92	95	97	100	102	105	110	115

PalmJet® Safety Air Guns

Innovation in the palm of your hand.





PalmJet® Safety Air Gun Series

Designed to be the most advanced, thumb-switch style safety air gun on the market today, the PalmJet features a comfortable, ergonomic handle and a rugged, stainless steel, 1/4" diameter extension – ideal for cleaning the tightest cavities. Choose from eight popular bent and straight extension configurations. Precision volume control sets the airflow – from a whisper to a blast. Star-tip nozzle provides OSHA compliance and superior, debris-cleaning performance. 1/4" FNPT inlet.

Features

- High impact, polypropylene body
- Soft rubber, ergonomic grip
- Extended, comfort trigger
- Generous hanging hook
- Precision, adjustable air volume control
- OSHA compliant, Star Tip nozzle
- Brass 1/4" FNPT inlet
- Meets OSHA standards

Part No.	Model/Description	Air Inlet FNPT (in)	Min. Compressor Required (hp)	Flow (cfm)	Output Thrust (lbs)	Noise Level (dBA)	Dimensions (L" x W" x H")	Weight (lbs)
GA4404S	With 4" Straight Extension	1/4	1.3	6	0.4	85	9.5 x 1 x 5	0.3
GA4404B	With 4" Bent Extension	1/4	1.3	6	0.4	85	9.4 x 1 x 5	0.3
GA4412S	With 12" Straight Extension	1/4	1.3	6	0.4	85	17.5 x 1 x 5	0.4
GA4412B	With 12" Bent Extension	1/4	1.3	6	0.4	85	17.4 x 1 x 5	0.4
GA4418S	With 18" Straight Extension	1/4	1.3	6	0.4	85	23.5 x 1 x 5	0.4
GA4418B	With 18" Bent Extension	1/4	1.3	6	0.4	85	23.4 x 1 x 5	0.4
GA4424S	With 24" Straight Extension	1/4	1.3	6	0.4	85	29.5 x 1 x 5	0.5
GA4424B	With 24" Bent Extension	1/4	1.3	6	0.4	85	29.4 x 1 x 5	0.5

Ultra[®] Safety Air Guns

The ultimate in comfort and performance.





Ultra® Venturi Series (Short Trigger)

Ideal for cleaning inaccessible and hard-to-reach areas. Efficient Venturi nozzle boosts thrust up to 300% over conventional air guns, yet limits static pressure to less than 30 psi should the tip become blocked. Patented, adjustable hanging hook can be repositioned for convenient storage. Ergonomic, cushioned pistol-grip style handle provides unparalleled comfort.

Features

- Cast aluminum body with premium cushion grip
- Contoured ergonomic trigger
- Adjustable hanging hook
- Aluminum extension
- Zinc alloy Venturi nozzle
- 1/4" or 3/8" FNPT inlet
- Meets OSHA standards

Part No.	Model/Description	Air Inlet FNPT (in)	Min. Compressor Required (hp)	Flow (cfm)	Output Thrust (lbs)	Noise Level (dBA)	Dimensions (L" x W" x H")	Weight (lbs)
U75LJ006AA2	With 6" Extension	3/8	11	49	2.8	104	9.7 x 1.2 x 6.6	1.0
U75LJ006AA225	With 6" Extension	1/4	8.9	40	1.9	97	9.7 x 1.2 x 6.6	1.0
U75LJ012AA2	With 12" Extension	3/8	11	49	2.8	104	15.7 x 1.2 x 6.6	1.1
U75LJ018AA2	With 18" Extension	3/8	11	49	2.8	104	21.7 x 1.2 x 6.6	1.2
U75LJ024AA2	With 24" Extension	3/8	11	49	2.8	104	27.7 x 1.2 x 6.6	1.3
U75LJ036AA2	With 36" Extension	3/8	11	49	2.8	104	39.7 x 1.2 x 6.6	1.5
U75LJ048AA2	With 48" Extension	3/8	11	49	2.8	104	51.7 x 1.2 x 6.6	1.7
U75LJ060AA2	With 60" Extension	3/8	11	49	2.8	104	63.7 x 1.2 x 6.6	1.9
U75LJ072AA2	With 72" Extension	3/8	11	49	2.8	104	75.7 x 1.2 x 6.6	2.1



Ultra® Venturi Series (Long Trigger)

Ideal for cleaning inaccessible and hard-to-reach areas. Efficient Venturi nozzle boosts thrust up to 300% over conventional air guns, yet limits static pressure to less than 30 psi should the tip become blocked. Patented, adjustable hanging hook can be repositioned for convenient storage. Ergonomic, cushioned pistol-grip style handle provides unparalleled comfort.

Features

- Cast aluminum body with premium cushion grip
- Full length contoured ergonomic trigger
- Adjustable hanging hook
- Aluminum extension
- Zinc alloy Venturi nozzle
- 3/8" FNPT inlet
- Meets OSHA standards

Part No.	Model/Description	Air Inlet FNPT (in)	Min. Compressor Required (hp)	Flow (cfm)	Output Thrust (lbs)	Noise Level (dBA)	Dimensions (L" x W" x H")	Weight (lbs)
U75LJ006AA3	With 6" Extension	3/8	11	49	2.8	104	9.7 x 1.2 x 6.6	1.0
U75LJ012AA3	With 12" Extension	3/8	11	49	2.8	104	15.7 x 1.2 x 6.6	1.1
U75LJ018AA3	With 18" Extension	3/8	11	49	2.8	104	21.7 x 1.2 x 6.6	1.2
U75LJ024AA3	With 24" Extension	3/8	11	49	2.8	104	27.7 x 1.2 x 6.6	1.3
U75LJ036AA3	With 36" Extension	3/8	11	49	2.8	104	39.7 x 1.2 x 6.6	1.5
U75LJ048AA3	With 48" Extension	3/8	11	49	2.8	104	51.7 x 1.2 x 6.6	1.7
U75LJ060AA3	With 60" Extension	3/8	11	49	2.8	104	63.7 x 1.2 x 6.6	1.9
U75LJ072AA3	With 72" Extension	3/8	11	49	2.8	104	75.7 x 1.2 x 6.6	2.1



Ultra® XtraThrust® Series (Short Trigger)

Ultra XtraThrust Series delivers maximum thrust along with superior performance and comfort. Engineered for the toughest applications and to move the heaviest debris, Generates the highest thrust in the Ultra Family yet limits static pressure to less than 30 psi should the tip become blocked. Patented, adjustable hanging hook can be repositioned for convenient storage. Ergonomic, cushioned pistol-grip style handle provides unparalleled comfort.

Features

- Cast aluminum body with premium cushion grip
- Contoured ergonomic trigger
- Adjustable hanging hook
- Aluminum extension
- Zinc alloy XtraThrust nozzle
- 1/4" or 3/8" FNPT inlet
- Meets OSHA standards

Part No.	Model/Description	Air Inlet FNPT (in)	Min. Compressor Required (hp)	Flow (cfm)	Output Thrust (lbs)	Noise Level (dBA)	Dimensions (L" x W" x H")	Weight (lbs)
U75XT006AA2	With 6" Extension	3/8	15	66	3.3	101	9.7 x 1.2 x 6.6	1.0
U75XT006AA225	With 6" Extension	1/4	15	66	3.3	101	9.7 x 1.2 x 6.6	1.0
U75XT012AA2	With 12" Extension	3/8	15	66	3.3	101	15.7 x 1.2 x 6.6	1.1
U75XT018AA2	With 18" Extension	3/8	15	66	3.3	101	21.7 x 1.2 x 6.6	1.2
U75XT024AA2	With 24" Extension	3/8	15	66	3.3	101	27.7 x 1.2 x 6.6	1.3
U75XT036AA2	With 36" Extension	3/8	15	66	3.3	101	39.7 x 1.2 x 6.6	1.5
U75XT048AA2	With 48" Extension	3/8	15	66	3.3	101	51.7 x 1.2 x 6.6	1.7
U75XT060AA2	With 60" Extension	3/8	15	66	3.3	101	63.7 x 1.2 x 6.6	1.9
U75XT072AA2	With 72" Extension	3/8	15	66	3.3	101	75.7 x 1.2 x 6.6	2.1



Ultra® XtraThrust® Series (Long Trigger)

Engineered for the toughest applications and to move the heaviest debris, Generates the highest thrust in the Ultra Family yet limits static pressure to less than 30 psi should the tip become blocked. Patented, adjustable hanging hook can be repositioned for convenient storage. Ergonomic, cushioned pistol-grip style handle provides unparalleled comfort.

Features

- Cast aluminum body with premium cushion grip
- Full length contoured ergonomic trigger
- Adjustable hanging hook
- Aluminum extension
- Zinc alloy XtraThrust nozzle
- 3/8" FNPT inlet
- Meets OSHA standards

Part No.	Model/Description	Air Inlet FNPT (in)	Min. Compressor Required (hp)	Flow (cfm)	Output Thrust (lbs)	Noise Level (dBA)	Dimensions (L" x W" x H")	Weight (lbs)
U75XT006AA3	With 6" Extension	3/8	15	66	3.3	101	9.7 x 1.2 x 6.6	1.0
U75XT012AA3	With 12" Extension	3/8	15	66	3.3	101	15.7 x 1.2 x 6.6	1.1
U75XT018AA3	With 18" Extension	3/8	15	66	3.3	101	21.7 x 1.2 x 6.6	1.2
U75XT024AA3	With 24" Extension	3/8	15	66	3.3	101	27.7 x 1.2 x 6.6	1.3
U75XT036AA3	With 36" Extension	3/8	15	66	3.3	101	39.7 x 1.2 x 6.6	1.5
U75XT048AA3	With 48" Extension	3/8	15	66	3.3	101	51.7 x 1.2 x 6.6	1.7
U75XT060AA3	With 60" Extension	3/8	15	66	3.3	101	63.7 x 1.2 x 6.6	1.9
U75XT072AA3	With 72" Extension	3/8	15	66	3.3	101	75.7 x 1.2 x 6.6	2.1



Ultra® WhisperJet® Series (Short Trigger)

Ultra WhisperJet Series incorporates exclusive WhisperJet nozzle technology to provide superior thrust at reduced noise levels. Ideal where low noise coupled with extended reach capability is required. Solid conical tip prevents nozzle blockage, thereby meeting OSHA requirements. Patented, adjustable hanging hook can be repositioned for convenient storage. Ergonomic, cushioned pistol-grip style handle provides unparalleled comfort.

Features

- Cast aluminum body with premium cushion grip
- Contoured ergonomic trigger
- Adjustable hanging hook
- Aluminum extension
- Aluminum WhisperJet nozzle
- 3/8" FNPT inlet
- Meets OSHA standards

Part No.	Model/Description	Air Inlet FNPT (in)	Min. Compressor Required (hp)	Flow (cfm)	Output Thrust (lbs)	Noise Level (dBA)	Dimensions (L" x W" x H")	Weight (lbs)
U80LJ006AA2	With 6" Extension	3/8	8.9	40	1.9	97	9.4 x 1.2 x 6.6	1.0
U80LJ012AA2	With 12" Extension	3/8	8.9	40	1.9	97	15.4 x 1.2 x 6.6	1.1
U80LJ018AA2	With 18" Extension	3/8	8.9	40	1.9	97	21.4 x 1.2 x 6.6	1.2
U80LJ024AA2	With 24" Extension	3/8	8.9	40	1.9	97	27.4 x 1.2 x 6.6	1.3
U80LJ036AA2	With 36" Extension	3/8	8.9	40	1.9	97	39.4 x 1.2 x 6.6	1.5
U80LJ048AA2	With 48" Extension	3/8	8.9	40	1.9	97	51.4 x 1.2 x 6.6	1.7
U80LJ060AA2	With 60" Extension	3/8	8.9	40	1.9	97	63.4 x 1.2 x 6.6	1.9
U80LJ072AA2	With 72" Extension	3/8	8.9	40	1.9	97	75.4 x 1.2 x 6.6	2.1



Ultra® WhisperJet® Series (Long Trigger)

Ultra WhisperJet Series incorporates exclusive WhisperJet nozzle technology to provide superior thrust at reduced noise levels. Ideal where low noise coupled with extended reach capability is required. Solid conical tip prevents nozzle blockage, thereby meeting OSHA requirements. Patented, adjustable hanging hook can be repositioned for convenient storage. Ergonomic, cushioned pistol-grip style handle provides unparalleled comfort.

Features

- Cast aluminum body with premium cushion grip
- Full length contoured ergonomic trigger
- Adjustable hanging hook
- Aluminum extension
- Aluminum WhisperJet nozzle
- 3/8" FNPT inlet
- Meets OSHA standards

Part No.	Model/Description	Air Inlet FNPT (in)	Min. Compressor Required (hp)	Flow (cfm)	Output Thrust (lbs)	Noise Level (dBA)	Dimensions (L" x W" x H")	Weight (lbs)
U80LJ006AA3	With 6" Extension	3/8	8.9	40	1.9	97	9.4 x 1.2 x 6.6	1.0
U80LJ012AA3	With 12" Extension	3/8	8.9	40	1.9	97	15.4 x 1.2 x 6.6	1.1
U80LJ018AA3	With 18" Extension	3/8	8.9	40	1.9	97	21.4 x 1.2 x 6.6	1.2
U80LJ024AA3	With 24" Extension	3/8	8.9	40	1.9	97	27.4 x 1.2 x 6.6	1.3
U80LJ036AA3	With 36" Extension	3/8	8.9	40	1.9	97	39.4 x 1.2 x 6.6	1.5
U80LJ048AA3	With 48" Extension	3/8	8.9	40	1.9	97	51.4 x 1.2 x 6.6	1.7
U80LJ060AA3	With 60" Extension	3/8	8.9	40	1.9	97	63.4 x 1.2 x 6.6	1.9
U80LJ072AA3	With 72" Extension	3/8	8.9	40	1.9	97	75.4 x 1.2 x 6.6	2.1



Ultra® WhisperJet® Safety Air Gun

Best in class bench-top gun, the Ultra WhisperJet incorporates exclusive WhisperJet nozzle technology to provide superior thrust at reduced noise levels. Solid conical tip prevents nozzle blockage, thereby meeting OSHA requirements. Ergonomic, cushioned pistol-grip style handle provides unparalleled comfort.

Features

- Cast aluminum body with premium cushion grip
- Contoured ergonomic trigger
- Aluminum WhisperJet nozzle
- 1/4" and 3/8" FNPT inlet versions available
- Meets OSHA standards

Part No.	Model/Description	Air Inlet FNPT (in)	Min. Compressor Required (hp)	Flow (cfm)	Output Thrust (lbs)	Noise Level (dBA)	Dimensions (L" x W" x H")	Weight (lbs)
U80WJ225	Ultra WhisperJet	1/4	8.9	40	1.9	97	5.3 x 1.2 x 6.6	0.9
U80WJ2	Ultra WhisperJet	3/8	8.9	40	1.9	97	5.3 x 1.2 x 6.6	0.9

Classic+ Safety Air Guns

Original "classic" design with OSHA-compliant features.





Original Safety Air Gun

First safety air gun to incorporate protective air cone technology to shield user from dangerous "chip fly-back." Powerful Venturi nozzle to draw in ambient air to increase thrust. Nozzle is permanently pinned to body to prevent tampering. Features ergonomic, Classic+ pistol grip-style handle for maximum user comfort.

Features

- Durable cast aluminum body with hanging hook
- Wide comfort trigger
- Precision air volume control
- Safety air shield
- Zinc alloy Venturi nozzle
- 1/4" FNPT inlet
- Meets OSHA standards

Part No.	Model/Description	Air Inlet FNPT (in)	Min. Compressor Required (hp)	Flow (cfm)	Output Thrust (lbs)	Noise Level (dBA)	Dimensions (L" x W" x H")	Weight (lbs)
57S30XB	Original Safety Air Gun	1/4	8	36	1	104	6 x 1 x 6.6	0.8



JetGuard Safety Air Gun

Featuring a proprietary, protective air cone to shield against dangerous "chip fly-back." Perfect for close-in applications. Ergonomic, Classic+ pistol grip-style handle provides maximum user comfort.

Features

- Durable cast aluminum body with hanging hook
- Wide comfort trigger
- Safety air shield
- Pinned tamper-proof nozzle
- 1/4" FNPT inlet
- Meets OSHA standards

Part No.	Model/Description	Air Inlet FNPT (in)	Min. Compressor Required (hp)	Flow (cfm)	Output Thrust (lbs)	Noise Level (dBA)	Dimensions (L" x W" x H")	Weight (lbs)
74S	JetGuard Safety Air Gun	1/4	7.8	35	0.4	102	5 x 1 x 6.6	0.7



JetGuard with Volume Control Safety Air Gun

Featuring a proprietary, protective air cone to shield against dangerous “chip fly-back.” Perfect for close-in applications. Ergonomic, Classic+ pistol grip-style handle provides maximum user comfort. Adjust the air flow from a whisper to a blast.

Features

- Durable cast aluminum body with hanging hook
- Wide comfort trigger
- Precision air volume control
- Safety air shield
- Pinned tamper-proof nozzle
- 1/4" FNPT inlet
- Meets OSHA standards

Part No.	Model/Description	Air Inlet FNPT (in)	Min. Compressor Required (hp)	Flow (cfm)	Output Thrust (lbs)	Noise Level (dBA)	Dimensions (L" x W" x H")	Weight (lbs)
74SK	JetGuard with Volume Control	1/4	7.8	35	0.4	102	5.5 x 1 x 6.6	0.7



Rubber Tip Safety Air Gun

Features a proprietary, protective air cone to shield against dangerous “chip fly-back” and a non-marring rubber tip. Perfect for close-in applications near painted or delicate surfaces. Additionally, the rubber tip’s conical shape allows an air-tight connection when blowing out fluid lines and holes. Ergonomic, Classic+ pistol grip-style handle provides maximum user comfort.

Features

- Durable cast aluminum body with hanging hook
- Wide comfort trigger
- Safety air shield
- Rubber tip nozzle
- 1/4" FNPT inlet
- Meets OSHA standards

Part No.	Model/Description	Air Inlet FNPT (in)	Min Compressor Required (hp)	Flow (cfm)	Output Thrust (lbs)	Noise Level (dBA)	Dimensions (L" x W" x H")	Weight (lbs)
74RT	Rubber Tip Safety Air Gun	1/4	11.1	50	0.5	113	6.5 x 1 x 5.6	0.7



XtraThrust® Safety Air Gun

Features the XtraThrust Venturi nozzle, and delivers over 300% more thrust than conventional air guns. Designed for tough, close-in work. Features ergonomic, Classic+ pistol grip-style handle for maximum user comfort. Most powerful Guardair bench-top gun.

Features

- Durable cast aluminum body with hanging hook
- Full length comfort trigger
- Zinc alloy XtraThrust Venturi nozzle
- 1/4" FNPT inlet
- Meets OSHA standards

Part No.	Model/Description	Air Inlet FNPT (in)	Min. Compressor Required (hp)	Flow (cfm)	Output Thrust (lbs)	Noise Level (dBA)	Dimensions (L" x W" x H")	Weight (lbs)
75XXT	XtraThrust Safety Air Gun	1/4	12	54	2.5	108	5.5 x 1 x 6.6	0.8



AirMiser Safety Air Gun

Ideal safety air gun for cost conscious compressed air users. Delivers powerful thrust, sufficient for most applications, while at the same time minimizing air consumption. Ergonomic, Classic+ pistol grip-style handle provides maximum user comfort.

Features

- Durable cast aluminum body with hanging hook
- Wide comfort trigger
- Low flow brass nozzle
- 1/4" FNPT inlet
- Meets OSHA standards

Part No.	Model/Description	Air Inlet FNPT (in)	Min. Compressor Required (hp)	Flow (cfm)	Output Thrust (lbs)	Noise Level (dBA)	Dimensions (L" x W" x H")	Weight (lbs)
74H	AirMiser Safety Air Gun	1/4	2.2	10	0.6	98	5.6 x 1 x 6.6	0.7



WhisperJet® Safety Air Gun

First safety air gun to incorporate exclusive WhisperJet nozzle technology to reduce air gun noise. Solid conical tip prevents blockage of nozzle. Ideal for cleaning bench tops, work stations, or machinery in noise sensitive areas. Features ergonomic, Classic+ pistol grip-style handle for maximum user comfort.

Features

- Durable cast aluminum body with hanging hook
- Wide comfort trigger
- Powerful aluminum WhisperJet silencer nozzle
- 1/4" FNPT inlet
- Meets OSHA standards

Part No.	Model/Description	Air Inlet FNPT (in)	Min. Compressor Required (hp)	Flow (cfm)	Output Thrust (lbs)	Noise Level (dBA)	Dimensions (L" x W" x H")	Weight (lbs)
80WJ	WhisperJet Safety Air Gun	1/4	4.4	20	1.1	93	4.9 x 1 x 6.6	0.6



WhisperJet® with Volume Control Safety Air Gun

First safety air gun to incorporate exclusive WhisperJet nozzle technology to reduce air gun noise. Solid conical tip prevents blockage of nozzle. Ideal for cleaning bench tops, work stations, or machinery in noise sensitive areas. Features ergonomic, Classic+ pistol grip-style handle for maximum user comfort.

Features

- Durable cast aluminum body with hanging hook
- Wide comfort trigger
- Precision air volume control
- Powerful aluminum WhisperJet silencer nozzle
- 1/4" FNPT inlet
- Meets OSHA standards

Part No.	Model/Description	Air Inlet FNPT (in)	Min. Compressor Required (hp)	Flow (cfm)	Output Thrust (lbs)	Noise Level (dBA)	Dimensions (L" x W" x H")	Weight (lbs)
80	WhisperJet with Volume Control	1/4	4.4	20	1.1	93	5.4 x 1 x 6.6	0.7



Booster Safety Air Gun Series

Delivers all the features of the 74S but with 25% more thrust. Ideal for stubborn and difficult applications where only the most powerful air gun will do. Proprietary, protective air cone shields against dangerous "chip fly-back." Ergonomic, Classic+ pistol grip-style handle provides maximum user comfort.

Features

- Durable cast aluminum body with hanging hook
- Wide comfort trigger
- Pinned, tamper proof, air-shield nozzle
- Screw-on brass extension
- 1/4" FNPT Inlet
- Meets OSHA standards

Part No.	Model/Description	Air Inlet FNPT (in)	Min. Compressor Required (hp)	Flow (cfm)	Output Thrust (lbs)	Noise Level (dBA)	Dimensions (L" x W" x H")	Weight (lbs)
76S006	With 6" Extension	1/4	7.8	35	0.5	104	10.6 x 1 x 6.6	0.7
76S012	With 12" Extension	1/4	7.8	35	0.5	104	16.6 x 1 x 6.6	0.8
76S018	With 18" Extension	1/4	7.8	35	0.5	104	22.6 x 1 x 6.6	0.8
76S024	With 24" Extension	1/4	7.8	35	0.5	104	28.6 x 1 x 6.6	0.9



Long John® Safety Air Gun Series

Perfect tool for cleaning inaccessible and hard-to-reach areas. Ideal for blowing floor debris, cleaning masonry forms, tanks, ovens, molds, and rafters, as well as machinery and storage areas. Efficient Venturi nozzle boosts thrust up to 200% over conventional air guns, yet limits static pressure to less than 30 psi should the tip become blocked. Ergonomic, Classic+ pistol grip-style handle provides maximum user comfort.

Features

- Durable cast aluminum body with hanging hook
- Wide comfort trigger
- Rugged aluminum extension
- Powerful zinc alloy Venturi nozzle
- 1/4" FNPT inlet
- Meets OSHA standards

Part No.	Model/Description	Air Inlet FNPT (in)	Min. Compressor Required (hp)	Flow (cfm)	Output Thrust (lbs)	Noise Level (dBA)	Dimensions (L" x W" x H")	Weight (lbs)
75LJ006AA	With 6" Extension	1/4	7.6	34	2	107	9.4 x 1 x 6.6	0.7
75LJ012AA	With 12" Extension	1/4	7.6	34	2	107	15.4 x 1 x 6.6	0.8
75LJ018AA	With 18" Extension	1/4	7.6	34	2	107	21.4 x 1 x 6.6	0.9
75LJ024AA	With 24" Extension	1/4	7.6	34	2	107	27.4 x 1 x 6.6	1.0
75LJ036AA	With 36" Extension	1/4	7.6	34	2	107	39.4 x 1 x 6.6	1.2
75LJ048AA	With 48" Extension	1/4	7.6	34	2	107	51.4 x 1 x 6.6	1.4
75LJ060AA	With 60" Extension	1/4	7.6	34	2	107	63.4 x 1 x 6.6	1.6
75LJ072AA	With 72" Extension	1/4	7.6	34	2	107	75.4 x 1 x 6.6	1.8



XtraThrust® Safety Air Gun Series

XtraThrust Series provides all the benefits of the Long John Series but with 40% more power. Ideal for the toughest applications and to move the heaviest debris, the XtraThrust nozzle generates over 300% more thrust compared to conventional air guns, yet limits static pressure to less than 30 psi should the tip become blocked. Ergonomic, Classic+ pistol grip-style handle provides maximum user comfort.

Features

- Durable cast aluminum body with hanging hook
- Full length comfort trigger
- Rugged aluminum extension
- Powerful zinc alloy XtraThrust nozzle
- 1/4" FNPT inlet
- Meets OSHA standards

Part No.	Model/Description	Air Inlet FNPT (in)	Min. Compressor Required (hp)	Flow (cfm)	Output Thrust (lbs)	Noise Level (dBA)	Dimensions (L" x W" x H")	Weight (lbs)
75XT006AA	With 6" Extension	1/4	12	54	2.8	108	9.4 x 1 x 6.6	0.7
75XT012AA	With 12" Extension	1/4	12	54	2.8	108	15.4 x 1 x 6.6	0.8
75XT018AA	With 18" Extension	1/4	12	54	2.8	108	21.4 x 1 x 6.6	0.9
75XT024AA	With 24" Extension	1/4	12	54	2.8	108	27.4 x 1 x 6.6	1.0
75XT036AA	With 36" Extension	1/4	12	54	2.8	108	39.4 x 1 x 6.6	1.2
75XT048AA	With 48" Extension	1/4	12	54	2.8	108	51.4 x 1 x 6.6	1.4
75XT060AA	With 60" Extension	1/4	12	54	2.8	108	63.4 x 1 x 6.6	1.6
75XT072AA	With 72" Extension	1/4	12	54	2.8	108	75.4 x 1 x 6.6	1.8



WhisperJet® Safety Air Gun Series

Perfect tool for cleaning inaccessible and hard-to-reach areas. Ideal for cleaning and blowing debris in noise sensitive environments. WhisperJet nozzles reduce noise 6 to 20 dB compared to conventional air guns.

Features

- Durable cast aluminum body with hanging hook
- Wide comfort trigger
- Rugged aluminum extension
- Aluminum WhisperJet nozzle
- 1/4" FNPT inlet
- Meets OSHA standards

Part No.	Model/Description	Air Inlet FNPT (in)	Min. Compressor Required (hp)	Flow (cfm)	Output Thrust (lbs)	Noise Level (dBA)	Dimensions (L" x W" x H")	Weight (lbs)
80LJ006AA	With 6" Extension	1/4	6.4	29	1.5	99	9.4 x 1 x 6.6	0.7
80LJ012AA	With 12" Extension	1/4	6.4	29	1.5	99	15.4 x 1 x 6.6	0.8
80LJ018AA	With 18" Extension	1/4	6.4	29	1.5	99	21.4 x 1 x 6.6	0.9
80LJ024AA	With 24" Extension	1/4	6.4	29	1.5	99	27.4 x 1 x 6.6	1.0
80LJ036AA	With 36" Extension	1/4	6.4	29	1.5	99	39.4 x 1 x 6.6	1.2
80LJ048AA	With 48" Extension	1/4	6.4	29	1.5	99	51.4 x 1 x 6.6	1.4
80LJ060AA	With 60" Extension	1/4	6.4	29	1.5	99	63.4 x 1 x 6.6	1.5
80LJ072AA	With 72" Extension	1/4	6.4	29	1.5	99	75.4 x 1 x 6.6	1.8



Flex Safety Air Gun Series

Flexible extension can be bent to any position to clean hard to reach places. No spring back or wander. Features quiet WhisperJet® nozzle, flexible extension, and Classic+ series grip.

Features

- Durable cast aluminum body with hanging hook
- Wide comfort trigger
- Aluminum WhisperJet nozzle
- Flexible synthetic rubber (160°F rated Modified Nitrile Type C2)
- 1/4" FNPT inlet
- Meets OSHA standards

Part No.	Model/Description	Air Inlet FNPT (in)	Min. Compressor Required (hp)	Flow (cfm)	Output Thrust (lbs)	Noise Level (dBA)	Dimensions (L" x W" x H")	Weight (lbs)
80FLEX12	With 12" Flex Extension	1/4	5.1	23	11	93	17.5 x 1 x 6.6	0.9
80FLEX18	With 18" Flex Extension	1/4	5.1	23	11	93	23.5 x 1 x 6.6	1.0
80FLEX24	With 24" Flex Extension	1/4	5.1	23	11	93	29.5 x 1 x 6.6	1.3
80FLEX36	With 36" Flex Extension	1/4	5.1	23	11	93	41.5 x 1 x 6.6	1.5



Nylon Safety Air Gun Series

Perfect for blowing out electrical cabinets and electronic equipment. Insulated nylon extension and nylon nozzle protects users from electrical shock hazards and protects equipment from damage due to accidental short circuits. Venturi nozzle boosts thrust up to 200% over conventional air guns, yet limits static pressure to less than 30 psi should the tip become blocked. Ergonomic Classic+ pistol grip-style handle with insulated plastic grip provides maximum comfort.

Features

- Durable cast aluminum body with hanging hook
- Wide comfort trigger
- Rugged nylon extension
- Powerful nylon nozzle
- 1/4" FNPT inlet
- Meets OSHA standards

Part No.	Model/Description	Air Inlet FNPT (in)	Min. Compressor Required (hp)	Flow (cfm)	Output Thrust (lbs)	Noise Level (dBA)	Dimensions (L" x W" x H")	Weight (lbs)
75LJ012NN	With 12" Extension	1/4	7.6	34	2	107	15.4 x 1 x 6.8	0.7
75LJ024NN	With 24" Extension	1/4	7.6	34	2	107	27.4 x 1 x 6.8	0.8
75LJ036NN	With 36" Extension	1/4	7.6	34	2	107	39.4 x 1 x 6.8	0.9

ThumbSwitch Safety Air Guns

Thumb-actuated, compact design for hard to reach areas.





ThumbSwitch Safety Air Gun

Compact design fits comfortably in the palm of your hand. Venturi nozzle delivers safe, yet powerful thrust.

Features

- Durable, cast aluminum body
- Thumb operated, comfortable, steel trigger
- Aluminum Venturi nozzle
- 1/4" FNPT inlet
- Meets OSHA standards

Part No.	Model/Description	Air Inlet FNPT (in)	Min. Compressor Required (hp)	Flow (cfm)	Output Thrust (lbs)	Noise Level (dBA)	Dimensions (L" x W" x H")	Weight (lbs)
900	ThumbSwitch Safety Air Gun	1/4	3.6	16	1.1	97	5.1 x 1 x 2.9	0.3



ThumbSwitch with Air Shield Safety Air Gun

Compact thumb-switch style design fits comfortably in the palm of your hand. Venturi nozzle delivers safe yet powerful thrust. Safety air shield provides protection from dangerous "chip-fly-back."

Features

- Durable, cast aluminum body
- Thumb operated, comfortable, steel trigger
- Aluminum Venturi nozzle with safety air shield
- 1/4" FNPT inlet
- Meets OSHA standards

Part No.	Model/Description	Air Inlet FNPT (in)	Min. Compressor Required (hp)	Flow (cfm)	Output Thrust (lbs)	Noise Level (dBA)	Dimensions (L" x W" x H")	Weight (lbs)
900S	ThumbSwitch with Air Shield	1/4	4.9	22	0.2	97	5.1 x 1 x 2.9	0.3



ThumbSwitch Safety Air Gun Series

Compact thumb-switch style design fits comfortably in the palm of your hand. Venturi nozzle delivers safe yet powerful thrust.

Features

- Durable, cast aluminum body
- Thumb operated, comfortable, steel trigger
- Aluminum extension
- Aluminum Venturi nozzle
- 1/4" FNPT inlet
- Meets OSHA standards

Part No.	Model/Description	Air Inlet FNPT (in)	Min. Compressor Required (hp)	Flow (cfm)	Output Thrust (lbs)	Noise Level (dBA)	Dimensions (L" x W" x H")	Weight (lbs)
900LJ006AA	With 6" Extension	1/4	3.6	16	1.1	100	9.4 x 1 x 2.9	0.4
900LJ012AA	With 12" Extension	1/4	3.6	16	1.1	100	15.4 x 1 x 2.9	0.4
900LJ018AA	With 18" Extension	1/4	3.6	16	1.1	100	21.4 x 1 x 2.9	0.4
900LJ024AA	With 24" Extension	1/4	3.6	16	1.1	100	27.4 x 1 x 2.9	0.5
900LJ036AA	With 36" Extension	1/4	3.6	16	1.1	100	39.4 x 1 x 2.9	0.5
900LJ048AA	With 48" Extension	1/4	3.6	16	1.1	100	51.4 x 1 x 2.9	0.6
900LJ060AA	With 60" Extension	1/4	3.6	16	1.1	100	63.4 x 1 x 2.9	0.7
900LJ072AA	With 72" Extension	1/4	3.6	16	1.1	100	75.4 x 1 x 2.9	0.7



WhisperJet® ThumbSwitch Safety Air Gun

Compact thumb-switch style design fits comfortably in the palm of your hand. WhisperJet nozzle reduces noise 7 to 11 dBA compared to conventional Venturi nozzles.

Features

- Durable, cast aluminum body
- Thumb operated, comfortable, steel trigger
- Aluminum WhisperJet nozzle
- 1/4" FNPT inlet
- Meets OSHA standards

Part No.	Model/Description	Air Inlet FNPT (in)	Min. Compressor Required (hp)	Flow (cfm)	Output Thrust (lbs)	Noise Level (dBA)	Dimensions (L" x W" x H")	Weight (lbs)
980	WhisperJet ThumbSwitch	1/4	4.2	19	0.9	89	6.6 x 1 x 2.9	0.4

Compact ThumbSwitch Safety Air Gun Series

Our most compact design fits comfortably in the palm of your hand. Venturi nozzle delivers safe, yet powerful thrust.

Features

- Durable cast zinc body
- Thumb operated, rubber cushioned, steel trigger
- Convenient hanging hook
- Brass Venturi nozzle
- 1/4" FNPT inlet
- Meets OSHA standards



Part No.	Model/Description	Air Inlet FNPT (in)	Min. Compressor Required (hp)	Flow (cfm)	Output Thrust (lbs)	Noise Level (dBA)	Dimensions (L" x W" x H")	Weight (lbs)
970	Compact ThumbSwitch	1/4	1.8	8	0.6	104	3.8 x 0.7 x 2.6	0.3
970003S	With 3" Extension	1/4	1.8	8	0.6	104	6.6 x 0.7 x 2.6	0.3
970006S	With 6" Extension	1/4	1.8	8	0.6	104	9.6 x 0.7 x 2.6	0.4
970012S	With 12" Extension	1/4	1.8	8	0.6	104	15.5 x 0.7 x 2.6	0.4
970018S	With 18" Extension	1/4	1.8	8	0.6	104	21.5 x 0.7 x 2.6	0.5

XtraThrust® ThumbSwitch Safety Air Gun

Our most compact design fits comfortably in the palm of your hand. Triple-port Venturi nozzle delivers safe yet powerful thrust.

Features

- Durable cast zinc body
- Rubber cushioned, steel trigger
- Convenient hanging hook
- Triple-port nozzle
- 1/4" FNPT inlet
- Meets OSHA standards



Part No.	Model/Description	Air Inlet FNPT (in)	Min. Compressor Required (hp)	Flow (cfm)	Output Thrust (lbs)	Noise Level (dBA)	Dimensions (L" x W" x H")	Weight (lbs)
970XT	XtraThrust ThumbSwitch	1/4	1.8	8	0.7	106	4.6 x 0.7 x 2.6	0.4

Lazer[®] Safety Air Guns

Compact design for maximum user comfort.





Lazer® PalmSwitch® Safety Air Gun

Featuring a revolutionary, contoured grip paired with a unique comfort trigger, the patented LZR600 is the ultimate palm switch style safety air gun. Designed to maximize operator comfort and reduce hand fatigue. Integrated hanging hook for intuitive storage and retrieval. Powerful, accurate. Perfect for DIY, automotive, and industrial cleaning applications.

Features

- Lightweight, all metal construction
- Ergonomic body with hanging hook
- Soft, over-molded rubber, comfort trigger
- Brass Venturi nozzle
- 1/4" FNPT inlet
- Meets OSHA standards

Part No.	Model/Description	Air Inlet FNPT (in)	Min. Compressor Required (hp)	Flow (cfm)	Output Thrust (lbs)	Noise Level (dBA)	Dimensions (L" x W" x H")	Weight (lbs)
LZR600	Lazer PalmSwitch	1/4	1.8	8	0.6	100	5.2 x 0.9 x 4	0.4



Lazer® Pistol Grip Safety Air Gun

With a unique, ergonomic, pistol-grip design, the LZR650 provides hours of fatigue-free operation. Integrated hanging eyelet for easy storage and retrieval. Powerful, accurate. Perfect for DIY, automotive, and industrial cleaning applications.

Features

- Lightweight, all metal construction
- Ergonomic body with hanging loop
- Wide, contoured trigger
- Brass Venturi nozzle
- 1/4" FNPT inlet
- Meets OSHA standards

Part No.	Model/Description	Air Inlet FNPT (in)	Min. Compressor Required (hp)	Flow (cfm)	Output Thrust (lbs)	Noise Level (dBA)	Dimensions (L" x W" x H")	Weight (lbs)
LZR650	Lazer Pistol Grip	1/4	1.8	8	0.6	100	5.1 x 0.9 x 4	0.5



Lazer® PalmSwitch® Safety Air Gun Kit

Featuring a revolutionary, contoured grip paired with a unique comfort trigger, the patented LZR600 is the ultimate palm switch style safety air gun. Designed to maximize operator comfort and reduce hand fatigue. Integrated hanging hook for intuitive storage and retrieval. Powerful, accurate. Perfect for DIY, automotive, and industrial cleaning applications.

Features

- LZR600 PalmSwitch Safety Air Gun
- Brass Venturi nozzle
- Brass booster nozzle
- Rubber tip nozzle
- 3" Venturi extension
- 6" Venturi extension
- 1/4" NPT Industrial Interchange connector

Part No.	Model/Description	Air Inlet FNPT (in)	Min. Compressor Required (hp)	Flow (cfm)	Output Thrust (lbs)	Noise Level (dBA)	Dimensions (L" x W" x H")	Weight (lbs)
LZR6007KIT	Lazer PalmSwitch Kit	1/4	1.8	8	0.6	100	5.2 x 0.9 x 4	0.8



Lazer® Pistol Grip Safety Air Gun Kit

Featuring a revolutionary, contoured grip paired with a unique comfort trigger, the patented LZR600 is the ultimate palm switch style safety air gun. Designed to maximize operator comfort and reduce hand fatigue. Integrated hanging hook for intuitive storage and retrieval. Powerful, accurate. Perfect for DIY, automotive, and industrial cleaning applications.

Features

- LZR650 Pistol Grip Safety Air Gun
- Brass Venturi nozzle
- Brass booster nozzle
- Rubber tip nozzle
- 3" Venturi extension
- 6" Venturi extension
- 1/4" NPT Industrial Interchange connector

Part No.	Model/Description	Air Inlet FNPT (in)	Min. Compressor Required (hp)	Flow (cfm)	Output Thrust (lbs)	Noise Level (dBA)	Dimensions (L" x W" x H")	Weight (lbs)
LZR6507KIT	Lazer Pistol Grip Kit	1/4	1.8	8	0.6	100	5.1 x 0.9 x 4	0.9



Lazer® PalmSwitch® Safety Air Gun Series

Featuring a revolutionary, contoured grip paired with a unique comfort trigger, the patented LZR600 PalmSwitch Series provides the ultimate in extended reach capability. Designed to maximize operator comfort and reduce hand fatigue. Integrated hanging hook for intuitive storage and retrieval. Powerful, accurate. Perfect for DIY, automotive, and industrial cleaning applications.

Features

- Lightweight, all metal construction
- Ergonomic body with hanging hook
- Soft, over-molded rubber, comfort trigger
- Aluminum extension
- Aluminum Venturi nozzle
- 1/4" FNPT inlet
- Meets OSHA standards

Part No.	Model/Description	Air Inlet FNPT (in)	Min. Compressor Required (hp)	Flow (cfm)	Output Thrust (lbs)	Noise Level (dBA)	Dimensions (L" x W" x H")	Weight (lbs)
LZR600006AA	With 6" Extension	1/4	2.9	13	0.9	101	10.1 x 0.9 x 3.3	0.7
LZR600012AA	With 12" Extension	1/4	2.9	13	0.9	101	16.1 x 0.9 x 3.3	0.8
LZR600018AA	With 18" Extension	1/4	2.9	13	0.9	101	22.1 x 0.9 x 3.3	0.8
LZR600024AA	With 24" Extension	1/4	2.9	13	0.9	101	28.1 x 0.9 x 3.3	0.8
LZR600036AA	With 36" Extension	1/4	2.9	13	0.9	101	40.1 x 0.9 x 3.3	0.8
LZR600048AA	With 48" Extension	1/4	2.9	13	0.9	101	52.1 x 0.9 x 3.3	0.9
LZR600060AA	With 60" Extension	1/4	2.9	13	0.9	101	64.1 x 0.9 x 3.3	0.9
LZR600072AA	With 72" Extension	1/4	2.9	13	0.9	101	76.1 x 0.9 x 3.3	0.9



Lazer® Pistol Grip Safety Air Gun Series

With a unique, ergonomic, pistol-grip design, the LZR650 Pistol Grip Series provides extended reach capability and fatigue-free operation. Integrated hanging eyelet for easy storage and retrieval. Powerful, accurate. Perfect for automotive and industrial cleaning applications.

Features

- Lightweight, all metal construction
- Ergonomic body with hanging loop
- Wide, contoured trigger
- Aluminum extension
- Aluminum Venturi nozzle
- 1/4" FNPT inlet
- Meets OSHA standards

Part No.	Model/Description	Air Inlet FNPT (in)	Min. Compressor Required (hp)	Flow (cfm)	Output Thrust (lbs)	Noise Level (dBA)	Dimensions (L" x W" x H")	Weight (lbs)
LZR650006AA	With 6" Extension	1/4	3.3	15	1.1	101	9 x 0.9 x 5.1	0.6
LZR650012AA	With 12" Extension	1/4	3.3	15	1.1	101	15 x 0.9 x 5.1	0.7
LZR650018AA	With 18" Extension	1/4	3.3	15	1.1	101	21 x 0.9 x 5.1	0.7
LZR650024AA	With 24" Extension	1/4	3.3	15	1.1	101	27 x 0.9 x 5.1	0.7
LZR650036AA	With 36" Extension	1/4	3.3	15	1.1	101	39 x 0.9 x 5.1	0.8
LZR650048AA	With 48" Extension	1/4	3.3	15	1.1	101	51 x 0.9 x 5.1	0.8
LZR650060AA	With 60" Extension	1/4	3.3	15	1.1	100	63 x 0.9 x 5.1	0.9
LZR650072AA	With 72" Extension	1/4	3.3	15	1.1	100	75 x 0.9 x 5.1	1.0

Big Air Guns

Big and powerful safety air guns for heavy-duty industrial and construction applications.





Force 5® Safety Air Gun Series

The most powerful safety air gun on the planet, the Force 5 Series is designed for heavy-duty industrial and construction cleaning applications. Built for the toughest environments, they deliver maximum compressed air when and where required. Featuring a dead-man trigger, the Force 5 Series is the safe alternative to dangerous, "home-made," ball valve actuated, open pipes. Engineered to be paired with tow-behind, or large in-plant compressors.

Features

- Rugged, lightweight, pistol-grip style aluminum handle
- Heavy-duty aluminum extension
- Adjustable auxiliary handle
- Powerful aluminum Venturi nozzle
- 3/4" FNPT inlet
- Meets OSHA standards

Part No.	Model/Description	Air Inlet FNPT (in)	Min. Compressor Required (hp)	Flow (cfm)	Output Thrust (lbs)	Noise Level (dBA)	Dimensions (L" x W" x H")	Weight (lbs)
F5024AA	With 24" Extension	3/4	41	185	12	121	36 x 10 x 12.5	4.5
F5036AA	With 36" Extension	3/4	41	185	12	121	48 x 10 x 12.5	4.9
F5048AA	With 48" Extension	3/4	41	185	12	121	60 x 10 x 12.5	5.3
F5060AA	With 60" Extension	3/4	41	185	12	121	72 x 10 x 12.5	5.7
F5072AA	With 72" Extension	3/4	41	185	12	121	84 x 10 x 12.5	6.1



Force 5® QuietForce® Safety Air Gun Series

Delivering high power at low noise levels, the Force 5 QuietForce Series is designed for heavy-duty industrial and construction cleaning applications where both attributes are required. Patented QuietForce nozzle features an array of micro-nozzles which produce high thrust at reduced noise levels. Featuring a dead-man trigger, the Force 5 QuietForce Series are the safe alternative to dangerous, "home-made," ball valve actuated, open pipes. Engineered to be paired with tow-behind, or large in-plant compressors.

Features

- Rugged, lightweight, pistol-grip style aluminum handle
- Heavy-duty aluminum extension
- Adjustable auxiliary handle
- QuietForce Nozzle
- 3/4" FNPT inlet
- Meets OSHA standards

Part No.	Model/Description	Air Inlet FNPT (in)	Min. Compressor Required (hp)	Flow (cfm)	Output Thrust (lbs)	Noise Level (dBA)	Dimensions (L" x W" x H")	Weight (lbs)
F5024AQF	With 24" Extension	3/4	29	130	7.1	101	32.8 x 10 x 12.5	4.4
F5036AQF	With 36" Extension	3/4	29	130	7.1	101	44.8 x 10 x 12.5	4.8
F5048AQF	With 48" Extension	3/4	29	130	7.1	101	56.8 x 10 x 12.5	5.2
F5060AQF	With 60" Extension	3/4	29	130	7.1	101	68.8 x 10 x 12.5	5.6
F5072AQF	With 72" Extension	3/4	29	130	7.1	101	80.8 x 10 x 12.5	6.0



Inforcer® Safety Air Gun Series

Designed as the “in-line” version of the Force 5, the Inforcer excels in heavy-duty industrial and construction cleaning applications. Built for the toughest environments, they deliver maximum compressed air where and when required. Featuring a dead-man trigger, the Inforcer Series are the safe alternative to dangerous, “home-made,” ball valve actuated, open pipes. Engineered to be paired with tow-behind, or large in-plant compressors.

Features

- Thermally insulated, in-line style, aluminum handle
- Heavy-duty aluminum extension
- Adjustable auxiliary handle
- Powerful aluminum Venturi nozzle
- 3/4" FNPT inlet
- Meets OSHA standards

Part No.	Model/Description	Air Inlet FNPT (in)	Min. Compressor Required (hp)	Flow (cfm)	Output Thrust (lbs)	Noise Level (dBA)	Dimensions (L" x W" x H")	Weight (lbs)
INF5024AA	With 24" Extension	3/4	41	185	12	121	34.4 x 3.4 x 12.5	4.1
INF5036AA	With 36" Extension	3/4	41	185	12	121	46.4 x 3.4 x 12.5	4.5
INF5048AA	With 48" Extension	3/4	41	185	12	121	58.4 x 3.4 x 12.5	4.8
INF5060AA	With 60" Extension	3/4	41	185	12	121	70.4 x 3.4 x 12.5	5.2
INF5072AA	With 72" Extension	3/4	41	185	12	121	82.4 x 3.4 x 12.5	5.6



Inforcer® QuietForce® Safety Air Gun Series

Delivering high power at low noise levels, the Inforcer QuietForce is designed for heavy-duty industrial and construction cleaning applications where both attributes are required. Patented QuietForce nozzle features an array of micro-nozzles which produce high thrust at reduced noise levels. Featuring a dead-man trigger, the Inforcer Series are the safe alternative to dangerous, “home-made,” ball valve actuated, open pipes. Engineered to be paired with tow-behind, or large in-plant compressors.

Features

- Thermally insulated, in-line style, aluminum handle
- Heavy-duty aluminum extension
- Adjustable auxiliary handle
- QuietForce® nozzle
- 3/4" FNPT inlet
- Meets OSHA standards

Part No.	Model/Description	Air Inlet FNPT (in)	Min. Compressor Required (hp)	Flow (cfm)	Output Thrust (lbs)	Noise Level (dBA)	Dimensions (L" x W" x H")	Weight (lbs)
INF5024AQF	With 24" Extension	3/4	29	130	7.1	101	31.2 x 3.4 x 12.5	4.0
INF5036AQF	With 36" Extension	3/4	29	130	7.1	101	43.2 x 3.4 x 12.5	4.4
INF5048AQF	With 48" Extension	3/4	29	130	7.1	101	55.2 x 3.4 x 12.5	4.8
INF5060AQF	With 60" Extension	3/4	29	130	7.1	101	67.2 x 3.4 x 12.5	5.1
INF5072AQF	With 72" Extension	3/4	29	130	7.1	101	79.2 x 3.4 x 12.5	5.5



Inforcer® Steel Safety Air Gun Series

Combining striking tool and air gun capabilities, the unique Inforcer Steel is perfect for surface preparation, roadwork, and concrete repair. Built for the toughest environments, they deliver maximum compressed air when and where required. Featuring a hardened steel chisel point nozzle and dead-man trigger, they are the safe alternative to dangerous, "home-made," ball valve actuated, open pipes. Engineered to be paired with tow-behind, or large in-plant compressors.

Features

- Thermally insulated, in-line style, steel handle
- Rugged steel extension
- Adjustable auxiliary handle
- Hardened steel, chisel point nozzle
- 3/4" FNPT inlet
- Meets OSHA standards

Part No.	Model/Description	Air Inlet FNPT (in)	Min. Compressor Required (hp)	Flow (cfm)	Output Thrust (lbs)	Noise Level (dBA)	Dimensions (L" x W" x H")	Weight (lbs)
INF5024SS	With 24" Extension	3/4	41	185	12	121	35 x 3.4 x 12.5	8.1
INF5036SS	With 36" Extension	3/4	41	185	12	121	47 x 3.4 x 12.5	8.9
INF5048SS	With 48" Extension	3/4	41	185	12	121	59 x 3.4 x 12.5	9.7
INF5060SS	With 60" Extension	3/4	41	185	12	121	71 x 3.4 x 12.5	10.6
INF5072SS	With 72" Extension	3/4	41	185	12	121	83 x 3.4 x 12.5	11.4



HydroForce® Power Wash Gun Series

Heavy-duty HydroForce power washer combines compressed air and standard municipal utility water to generate superior cleaning power. No external pressure unit or power package; requires no electricity, or gasoline. Single trigger operation provides convenient air/water operation. Turn off water with water shutoff valve (included) for air-only drying. Virtually maintenance free. Hot or cold water capable. Perfect for mobile applications where portability is at a premium.

Features

- Rugged, lightweight, ergonomic aluminum handle
- Stainless steel extension
- Adjustable auxiliary handle
- Aluminum safety tip nozzle
- Max water temperature - 200°F
- Air - 3/4" FNPT
- Water - Garden hose connector (female)
- Meets OSHA standards

Part No.	Model/Description	Air Inlet FNPT (in)	Syphon Flow Rate (gpm)	Flow (cfm)	Output Thrust (lbs)	Noise Level (dBA)	Dimensions (L" x W" x H")	Weight (lbs)
HYD024SSA	With 24" Extension	3/4	3.4	140	13.5	99	38 x 10 x 19.9	6.7
HYD036SSA	With 36" Extension	3/4	3.4	140	13.5	99	50 x 10 x 19.9	7.7
HYD048SSA	With 48" Extension	3/4	3.4	140	13.5	99	62 x 10 x 19.9	8.5

Specialty Air Guns

Air guns for specialty applications.



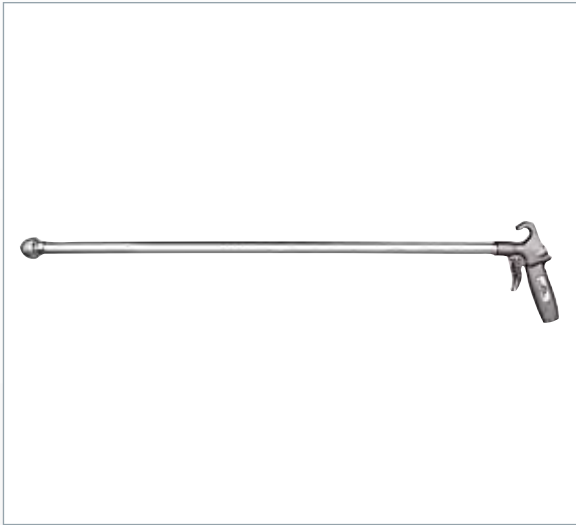

ReverseForce® Air Gun

Harnessing the power of compressed air, the ReverseForce Air Gun effectively extracts metal chips and debris from deep inside axle housings, hydraulic cylinders, machine cavities and gear boxes. Faster than conventional cleaning methods, the ReverseForce extracts rather than drives chips and debris further into interior of machinery. Light-weight and easy to handle.

Features

- Durable cast aluminum body with hanging hook
- Wide comfort trigger
- Rugged, 48" aluminum extension
- Powerful, aluminum ReverseForce Nozzle
- 1/4" FNPT inlet

Part No.	Model/Description	Air Inlet FNPT (in)	Min. Compressor Required (hp)	Flow (cfm)	Noise Level (dBA)	Dimensions (L" x W" x H")	Weight (lbs)
75RF048AA	ReverseForce Air Gun	1/4	8.2	37	93	51 x 1.4 x 6.6	1.4

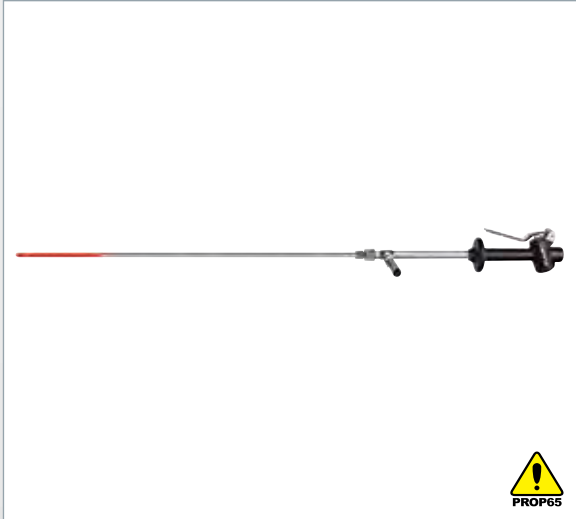

Radiator Gun

Airborne dust, dirt, trash and debris can be a real problem for cooling systems in heavy equipment and vehicle engines. Ineffective cleaning of radiator fins and other surfaces can lead to engine overheating or failure. Designed to quickly and effectively blast away debris, the Radiator Gun features a bi-directional multi-port, linear nozzle that delivers a powerful, wide spray pattern of compressed air. Featuring a 1/2" diameter, 60" heavy-duty stainless steel extension, this configuration provides unparalleled cleaning within hard-to-access radiator housings and engine bays. Equipped with a 3/4" FNPT inlet, the Radiator Gun can also be ordered with a swivel universal coupling. Compressed air is typically supplied by a 185 cfm tow-behind, or stationary in-plant compressor.

Features

- Multi-port linear, 95 cfm nozzle
- 1/2" diameter, 60" stainless steel extension
- In-line style handle with thermally insulated grip
- Adjustable auxiliary handle
- 3/4" FNPT Inlet

Part No.	Model/Description	Air Inlet FNPT (in)	Min. Compressor Required (hp)	Flow (cfm)	Noise Level (dBA)	Dimensions (L" x W" x H")	Weight (lbs)
INRG060SS	Radiator Gun	3/4	21	95	101	69.4 x 12.5 x 4.7	4.7
INRG060SSJ34	Radiator Gun with Swivel Universal Coupling	3/4	21	95	101	72.1 x 12.5 x 4.7	5.5



Filter Cleaning Gun Series

Extend the life of expensive air filters with the Filter Cleaning Gun – an essential tool for general maintenance and automotive use. Powered by standard shop compressed air, the bi-directional, multi-port nozzle delivers a linear spray pattern of compressed air from opposite sides of the nozzle. Perfect for removing impurities from various types of air filters. Effectively cleans radiators and other surfaces.

Features

- Easier and more efficient than traditional manual cleaning
- Unique bi-directional design eliminates dangerous “extension whipping” commonly experienced when air can only exit one direction
- Multiple extension lengths available (12", 24", 36" and 48")
- Comfortable, thumb-switch style trigger
- Lightweight, aluminum construction
- 1/4" FNPT inlet

Part No.	Model/Description	Air Inlet FNPT (in)	Min. Compressor Required (hp)	Flow (cfm)	Output Thrust (lbs)	Noise Level (dBA)	Dimensions (L" x W" x H")	Weight (lbs)
900FG012	With 12" Extension	1/4	6	24	0.6	92	15 x 1 x 2.9	0.4
900FG024	With 24" Extension	1/4	6	24	0.6	92	27 x 1 x 2.9	0.4
900FG036	With 36" Extension	1/4	6	24	0.6	92	39 x 1 x 2.9	0.5
900FG048	With 48" Extension	1/4	6	24	0.6	92	51 x 1 x 2.9	0.6



Blind Hole® Safety Air Gun Series

Specifically designed to clean out blind holes in metal, wood, and plastic work pieces. Delivers a high velocity jet of air into deep crevices and blind holes to flush out chips and dirt. Proprietary, protective air cone shields against dangerous “chip fly-back.” Ergonomic, Classic+ pistol grip-style handle provides maximum user comfort.

Features

- Durable cast aluminum body with hanging hook
- Wide comfort trigger
- Safety air shield
- 3/16" OD brass extension with 1/8" OD plastic stylus tip
- 1/4" FNPT inlet
- Meets OSHA standards

Part No.	Model/Description	Air Inlet FNPT (in)	Min. Compressor Required (hp)	Flow (cfm)	Output Thrust (lbs)	Noise Level (dBA)	Dimensions (L" x W" x H")	Weight (lbs)
74BH006Z	With 6" Extension	1/4	7.8	35	0.1	103	12 x 1 x 6.6	0.7
74BH012Z	With 12" Extension	1/4	7.8	35	0.1	103	18 x 1 x 6.6	0.7
74BH018Z	With 18" Extension	1/4	7.8	35	0.1	103	24 x 1 x 6.6	0.7
74BH024Z	With 24" Extension	1/4	7.8	35	0.1	103	30 x 1 x 6.6	0.8

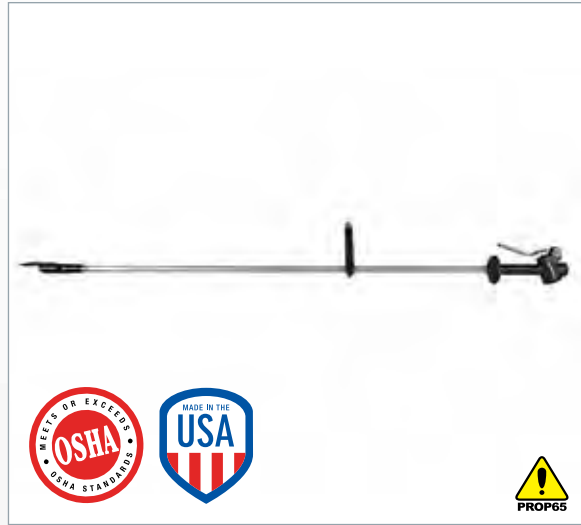

Inforcer® Steel with Scraper Nozzle Safety Air Gun

Featuring a hardened, steel scraper nozzle and Inforcer style handle, this safety air gun provides superior scraping and chiseling power coupled with compressed air to blast away debris. Commonly used in foundries for breaking slag off the walls of crucibles, in construction for demo work, or on railways for track maintenance. Comes with a 60" steel extension and handle to withstand heavy impact. OSHA compliant.

Features

- Thermally insulated, in-line style, steel handle
- Rugged 60" steel extension
- Heavy-duty adjustable auxiliary handle
- Hardened steel, scraper nozzle
- 3/4" FNPT inlet
- Meets OSHA standards

Part No.	Model/Description	Air Inlet FNPT (in)	Min. Compressor Required (hp)	Flow (cfm)	Noise Level (dBA)	Dimensions (L" x W" x H")	Weight (lbs)
INF5060SNS	Inforcer Steel 60" with Scraper Nozzle	3/4	41	185	121	72.3 x 3.4 x 12.5	12

Syphon Guns

Pneumatic spray guns designed to spray a wide variety of liquids.

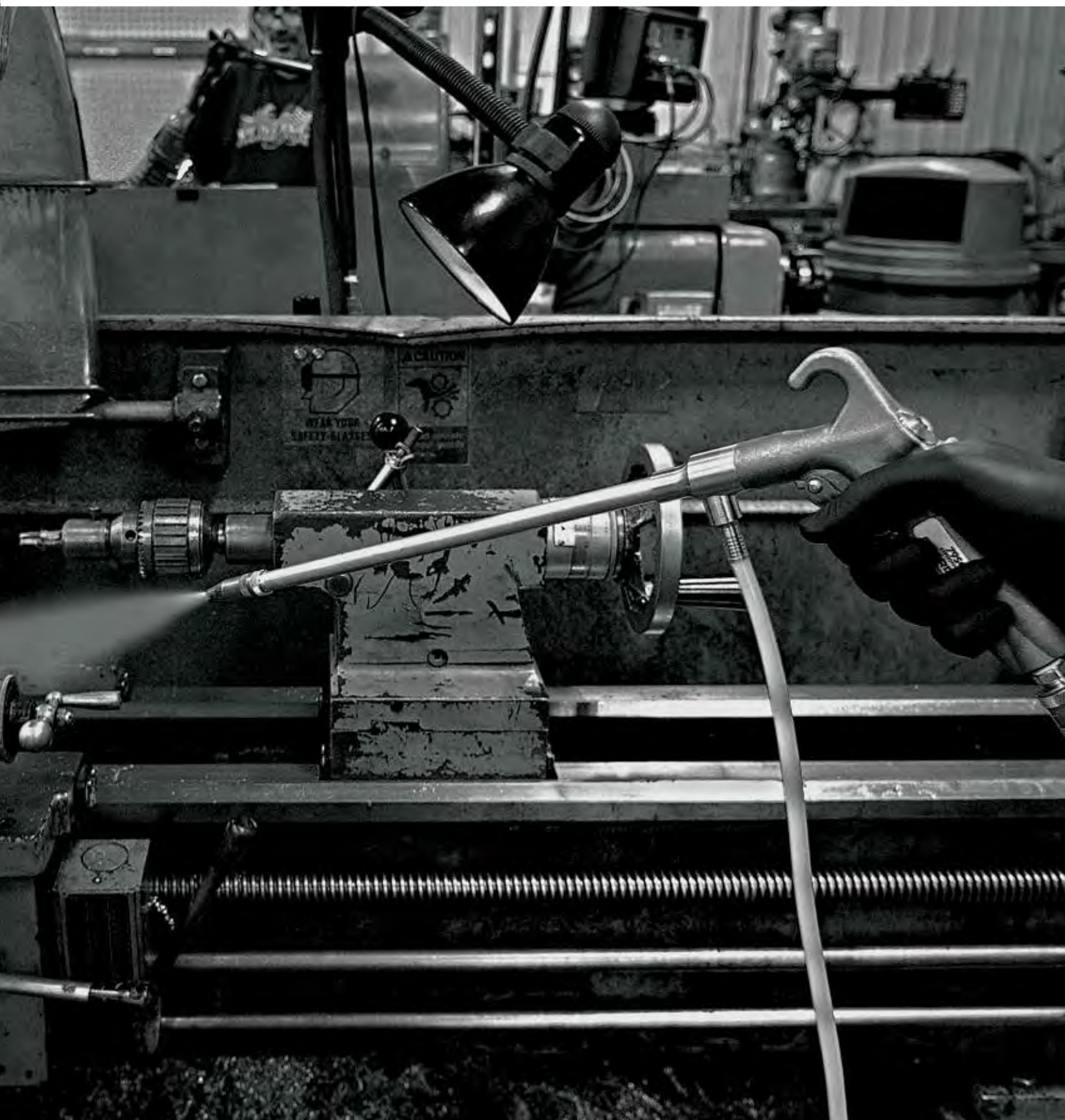



Syphon Gun

Economical 79SG Syphon Gun features a powerful syphon that delivers up to 12 gallons of liquid per hour. Incorporates separate liquid shutoff valve for operating flexibility. Easy to clean. Classic+ pistol-grip style handle provides maximum user comfort.

Features

- Durable cast aluminum body with hanging hook
- Wide comfort trigger
- Liquid shutoff valve
- 6' long, 1/4" ID, clear PVC feed tube with brass sinker
- 1/4" ID aluminum nozzle
- 1/4" FNPT inlet

Part No.	Model/Description	Air Inlet FNPT (in)	Min. Compressor Required (hp)	Flow (cfm)	Syphon Flow Rate (gph)	Dimensions (L" x W" x H")	Weight (lbs)
79SG	Syphon Spray Gun	1/4	2	9	12	5 x 1.8 x 6.6	0.9



Syphon Spray Gun Series

Designed for heavy-duty use, the versatile Syphon Spray Gun is ideal for spraying oils, solvents, insecticides, and coatings. Powerful syphon delivers up to 16 gallons of liquid per hour. Features 12" extension for spraying hard-to-reach locations Adjustable nozzle tip controls flow and spray pattern. Classic+ pistol-grip style handle provides maximum user comfort.

Features

- Durable cast aluminum body with hanging hook
- Wide comfort trigger
- 6', 1/4" ID, clear PVC feed tube with brass sinker
- Rugged aluminum extension
- Brass nozzle tip
- 1/4" FNPT inlet

Part No.	Model/Description	Air Inlet FNPT (in)	Min. Compressor Required (hp)	Flow (cfm)	Syphon Flow Rate (gph)	Dimensions (L" x W" x H")	Weight (lbs)
79SG006	With 6" Extension	1/4	2	9	16	12.3 x 1 x 6.6	1.1
79SG012	With 12" Extension	1/4	2	9	16	18.3 x 1 x 6.6	1.1
79SG018	With 18" Extension	1/4	2	9	16	24.3 x 1 x 6.6	1.2
79SG024	With 24" Extension	1/4	2	9	16	30.3 x 1 x 6.6	1.3
79SG036	With 36" Extension	1/4	2	9	16	42.3 x 1 x 6.6	1.4
79SG048	With 48" Extension	1/4	2	9	16	54.3 x 1 x 6.6	1.6
79SG060	With 60" Extension	1/4	2	9	16	66.3 x 1 x 6.6	1.7

Note: Fluids incompatible with zinc, aluminum, brass, Buna-n and PVC not recommended for use with Guardair Syphon Guns.



Syphon Gun

The 79SGM Syphon Gun is designed for the toughest spray jobs imaginable. Powerful syphon delivers up to 12 gallons of liquid per hour. Precision air volume control ensures spray repeatability. One quart steel canister screws into gun body, eliminating feed tubes and buckets, and reduces the risk of spills. Classic+ pistol-grip style handle provides maximum user comfort. Conforms to MIL-G-952 Type 1.

Features

- Durable cast aluminum body with hanging hook
- Wide comfort trigger
- Precision air volume control
- One quart, screw-on, steel canister
- 6" rigid, 12" flexible, nylon extensions
- 1/4" FNPT inlet

Part No.	Model/Description	Air Inlet FNPT (in)	Min. Compressor Required (hp)	Flow (cfm)	Syphon Flow Rate (gph)	Dimensions (L" x W" x H")	Weight (lbs)
79SGM	Syphon Spray Gun	1/4	1.8	8	12	6.5 x 4.5 x 7.6	1.6



Pneumatic Oil Gun

Perfect for lubricating automobiles, trucks, construction equipment, and machinery, the 83SG Pneumatic Oil Gun delivers up to 15 gallons of liquid per hour. 12" extension reaches inaccessible locations while the adjustable nozzle tip controls flow and spray pattern. Precision air volume control ensures spray repeatability. One quart steel container screws into gun body. Classic+ pistol-grip style handle provides maximum user comfort. Conforms to MIL-O-14 559C.

Features

- Durable cast aluminum body with hanging hook
- Wide comfort trigger
- Precision air volume control
- One quart, screw-on, steel canister
- 12" extension with adjustable nozzle tip
- 1/4" FNPT inlet

Part No.	Model/Description	Air Inlet FNPT (in)	Min. Compressor Required (hp)	Flow (cfm)	Syphon Flow Rate (gph)	Dimensions (L" x W" x H")	Weight (lbs)
83SG	Pneumatic Oil Gun	1/4	2	9	15	20 x 4.5 x 7.6	1.7

Note: Fluids incompatible with zinc, aluminum, brass, Buna-n and PVC not recommended for use with Guardair Syphon Guns.



WaterJet Cleaning Gun

79WG WaterJet Cleaning Gun is ideal for cleaning farm and construction equipment, automobiles, trucks, or livestock. Delivers turbulent, high velocity, air/water stream for the toughest cleaning jobs. Equipped with air volume control and water shutoff valve, user can choose air/water for cleaning, water only for rinse, or air only for drying. Features 15" stainless steel extension for spraying hard-to-reach locations. Classic+ pistol-grip style handle provides maximum user comfort.

Features

- Durable cast aluminum body with hanging hook
- Precision air volume control and water shutoff valve
- 15" stainless steel extension with insulated grip
- Aluminum safety tip nozzle
- Max water temperature - 200° F
- Air inlet - 1/4" FNPT
- Liquid inlet - 3/4" garden hose (female)
- Meets OSHA standards

Part No.	Model/Description	Air Inlet FNPT (in)	Min. Compressor Required (hp)	Flow (cfm)	Syphon Flow Rate (gph)	Dimensions (L" x W" x H")	Weight (lbs)
79WG	WaterJet Cleaning Gun	1/4	3.3	15	22	19.1 x 1.9 x 6.6	1.5



WaterJet Cleaning Gun Kit

79WGD WaterJet Cleaning Gun Kit is ideal for cleaning farm and construction equipment, automobiles, trucks, or livestock. Delivers turbulent, high velocity, air/water stream for the toughest cleaning jobs. Equipped with air volume control and water shutoff valve, user can choose air/water for cleaning, water only for rinse, or air only for drying. Coupler allows multiple syphon options. Features 15" stainless steel extension for spraying hard-to-reach locations. Classic+ pistol-grip style handle provides maximum user comfort.

Features

- Durable cast aluminum body with hanging hook
- Precision air volume adjustment and water shutoff valve
- 15" stainless steel extension with insulated grip
- Aluminum safety tip nozzle
- 6' feed tube with brass sinker; 3/4" garden hose adapter
- Maximum recommended water temperature - 200° F
- Air inlet - 1/4" FNPT
- Liquid inlet - 1/4" US Industrial Interchange
- Meets OSHA standards

Part No.	Model/Description	Air Inlet FNPT (in)	Min. Compressor Required (hp)	Flow (cfm)	Syphon Flow Rate (gph)	Dimensions (L" x W" x H")	Weight (lbs)
79WGD	WaterJet Cleaning Gun Kit	1/4	3.3	15	22	19.1 x 1.9 x 7.5	2.1

Safety Air Gun Accessories

Upgrade and accessorize your safety air gun.





On-Guard® Chip Shield

Protect against dangerous “chip fly-back” with the Guardair On-Guard Chip Shield. OSHA Standard 1910.242(b) mandates that effective chip-guarding be utilized when cleaning with compressed air. Slide the On-Guard onto a safety air gun for immediate compliance. Ideal for bench-top or up-close cleaning applications.

Part No.	Model/Description
200A65	PalmJet Models
200A66	Long John, XtraThrust, WhisperJet, Ultra Models*
200A67	ReverseForce Models

* Extended reach models only



500A20

Sidekick Auxiliary Support Handle

Provides extra stability and control for your extended reach gun. Clamps in any position or orientation. Twist to tighten. Fits all Guardair Long John, XtraThrust, WhisperJet and Ultra Series Air Guns



Slip-on Grip

Soft plastic slip-on grip provides thermal protection and extra comfort for air gun users. Slips on and stays on. Fits all Guardair Classic+ style handles. Quickly install with heat gun.

Part No.	Model/Description
350G01	Blue Slip-on Grip
350G02	Blue Slip-on Grip (12 pack)
350G05	Black Slip-on Grip



QTSN140

Quiet-Test Silencer Nozzle

Test tow-behind compressors in the “full-on” mode safely and quietly with Quiet-Test Silencer Nozzle. Patented QuietForce technology reduces noise levels up to 20 dB.



510A01

HydroForce® Shoulder Strap

Comfortable shoulder strap clips onto HydroForce handle to reduce fatigue. Transfers weight from hands to shoulders.



510A20

Pigtail Hose Assembly for HydroForce®

5' air/water pigtail hose assembly maximizes the utility of the HydroForce. Minimizes hose kinking; eases handling.

Replacement Parts

Repair kits and parts for your safety air gun.



NOZZLE REPLACEMENT PARTS

	For Model No.	Description	Part No.	Nozzle Material	Nozzle Thread
	74H	AirMiser Nozzle	74HNB	Brass	Male 1/8-27 NPS
	74RT	Rubber Tip Nozzle	74NRT	Rubber Tip Steel Threads	Male 1/8-27 NPS
	74S 74SK	JetGuard Nozzle* <small>*not compatible with 74E, 76S, or 74BH series</small>	74N02A*	Brass	Male 1/8-27 NPS
	LZR600 LZR650 970	Brass Venturi Nozzle	LZRN02	Brass	Male 1/8-27 NPS
	LZR600 LZR650 970XT	Brass Triple-Port Nozzle	LZRN03	Brass	Male 1/8-27 NPS
	900 900S	Venturi Nozzle Venturi Nozzle with Air Shield	900NA 900SNA	Aluminum Aluminum	Male 1/4-18 NPT
	75LJ U75LJ	Venturi Nozzle	75LJNA-1 75LJNS 75LJNN 75LJNB	Zinc Alloy Steel Nylon Brass	Male 5/8-28 UN
	75XT U75XT	XtraThrust Nozzle	75XTNA-1 75XTNS 75XTNN	Zinc Alloy Steel Nylon	Male 5/8-28 UN
	80LJ U80LJ	WhisperJet Nozzle	80LJNA	Aluminum	Female 3/4-32 UN
	80WJ	WhisperJet Nozzle	80WJNA	Aluminum	Male 3/4-32 UN
	80FLEX 980	WhisperJet Nozzle	84CNA	Aluminum	Male 1/4-18 NPT
	F5 INF5	Venturi Nozzle	500NA 550N01	Aluminum Steel	Female 1/2-14 NPT
	F5 INF5	QuietForce Nozzle	500NQF	Aluminum Body Steel Shroud	Female 1/2-14 NPT
	HYD	HydroForce Nozzle	510N02	Aluminum	Female 1/2-14 NPT





Extension with Venturi Nozzle

Aluminum extension with Venturi nozzle. For Classic+ and Ultra handles. 6" to 72" lengths available. 3/4"-32 UN male thread.

See website for all extensions



Venturi Nozzle with Aluminum Extension

Aluminum extension with Venturi Nozzle for Force 5 and Inforcer handles. 24" to 72" lengths available. 1/2"-14 NPT male thread.

See website for all extensions



Extension with XtraThrust® Nozzle

Aluminum extension with XtraThrust nozzle. For Classic+ and Ultra handles. 6" to 72" lengths available. 3/4"-32 UN male thread.

See website for all extensions



Chisel Point Nozzle & Steel Extension

Steel extension with hardened steel chisel point nozzle for Inforcer Steel handle. 24" to 72" lengths available. 1/2"-14 NPT male thread.

See website for all extensions



Extension with WhisperJet® Nozzle

Aluminum extension with WhisperJet nozzle. For Classic+ and Ultra handles. 6" to 72" lengths available. 3/4"-32 UN male thread.

See website for all extensions

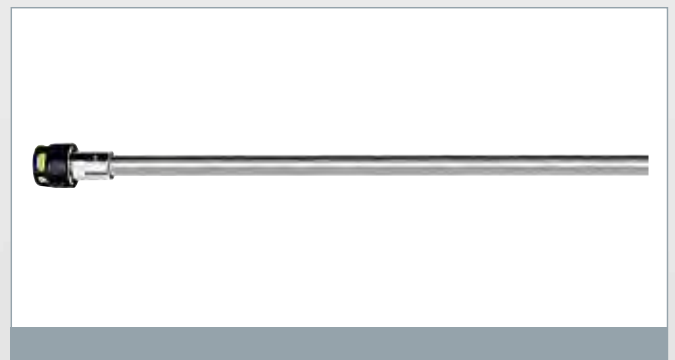

QuietForce® Nozzle & Aluminum Extension

QuietForce nozzle/extension assembly for Force 5 and Inforcer handles. Rugged, lightweight QuietForce nozzle delivers high power, low noise cleaning capability. 24" to 72" lengths available. 1/2"-14 NPT male thread.

See website for all extensions

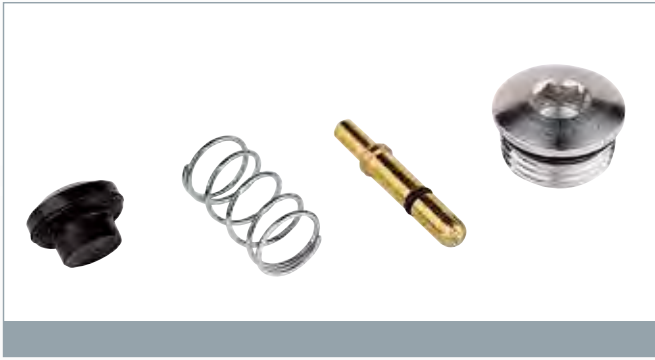

Valve Repair Kit

Refurbish Guardair safety air guns.

Part No.	Description	Models
74PK01	Standard Valve Repair Kit	74BH, 74H, 74S, 74RT, 76S, 80WJ, 80LJ, 75LJ, 75XT, 79SG, 1500, 1510, 1548, U75LJ, U75XT, U80, U80LJ, U80WJ
74PK03	Volume Adjust Repair Kit	57S, 74SK, 80, 79SGM, 79WG, 83SG
900K01	900 Valve Repair Kit	900, 900S, 900LJ, 980
500K01	Big Air Gun Valve Repair Kit	F5, INF5, HYD

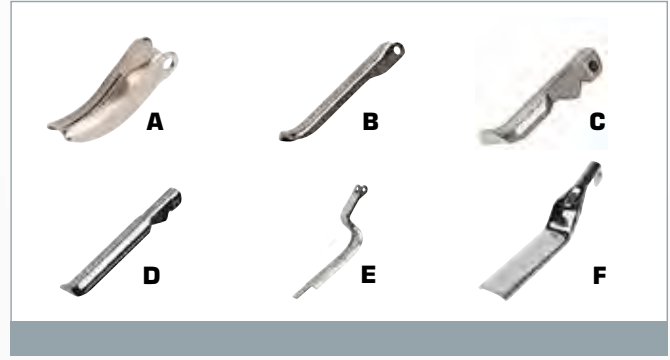

Trigger Repair Kit

Includes new trigger and rivet.

Part No.	Description	Figure
TRP01	Classic+ Short Trigger Repair Kit	A
TRP02	Classic+ Long Trigger Repair Kit	B
TRU01	Ultra Short Trigger Repair Kit	C
TRU02	Ultra Long Trigger Repair Kit	D
500K02-1	Force 5 Trigger Repair Kit	E
550K02	Inforcer Trigger Repair Kit	F



Gun Rebuild Kit

Includes valve repair kit and trigger repair kit.

Part No.	Description	Figure
400K02	For Ultra Series with Short Trigger	A
400K03	For Ultra Series with Long Trigger	B



HydroForce® Shuttle Valve Maintenance Kit

Replace the HydroForce shuttle valve with this 6 piece, maintenance kit.

Can't find the replacement part you're looking for?

**Visit www.guardair.com
or call 800-482-7324**

and speak with our product support team.

Shop Accessories

Keep your shop organized with innovative solutions from Guardair.





Chip Collector Lid

Maintain a clean shop environment with the Chip Collector Lid. Captures metal chips and airborne oils generated when cleaning newly machined parts with compressed air. Wide opening with adjustable, clear-view shield provides for safe inspection of parts while cleaning. Chips and oils deflect into barrel below for easy disposal. Includes dual, removable part bins, and hanging hooks for your favorite safety air gun or tools. Compatible with any 55 gallon drum or 44 & 55 gallon trash barrel.

Features

- Chemical resistant, lightweight polyethylene body
- Wide (11" x 15") opening with adjustable, clear-view shield
- Fits standard 55 gallon drum or 44 & 55 gallon trash barrels
- Dual, removable part bins
- Front drip tray
- Top storage tray

Part No.	Description	Dimensions (L" x W" x H")	Weight (lbs)
CC250	Chip Collector Lid	30.5 x 34.5 x 18	13.8



QuickSelect™ Tool Rack

Keep your favorite tools within easy reach with the QuickSelect Tool Rack. Organize your shop and avoid searching through drawers, or piles of clutter for that special tool. Made from heavy-duty aluminum, the QuickSelect features an array of slots and holes sized to accommodate most popular tools, such as Allen wrenches, dead blow hammers, screwdrivers, and safety air guns. Also included is a plastic bushing for storing sensitive instruments such as tool holders or gauges, making the QuickSelect the perfect accessory for CNC machining centers. Presents a slim profile without intruding into active workspaces.

Choose from two versions -- with eight holes for custom mounting, or with dual, high-strength magnets for quick mounting on steel surfaces.

Features

- Durable, 1/8" aluminum construction
- 15 holes and slots sized for the most popular tools
- 1-3/4" diameter hole with removable plastic bushing
- Multiple mounting options
- Magnets provide 190 lbs. axial holding force
- 12" L x 5" W x 4" H

Part No.	Description	Dimensions (L" x W" x H")	Weight (lbs)
200A70	QuickSelect Tool Rack - Non-Magnetic	12 x 5 x 4	0.8
200A75	QuickSelect Tool Rack - Magnetic	12 x 5 x 4	2.0



200A30

Gunslinger®

Provides a convenient place to store extended reach safety air guns. Keeps tools ready for immediate use. No drilling required. Strong magnets grip iron or steel surfaces.

Features

- Sturdy, high density polyethylene
- Tube: 12" Long x 1-1/4" ID
- Magnets: 3-1/4" OD
- Up to 190 lbs of combined holding strength
- Weight 1.4 lbs



200A40

MagHook

Hang your air gun from any iron or steel surface with this versatile, magnetic hanging hook. No drilling required.

Features

- Rugged, metal construction
- Hook measures 2-1/4" long
- Magnet: 3-1/4" OD
- Axial holding force of 95 lbs
- Weight 0.6 lbs



200A50

MagLoop

Hang your air gun from any iron or steel surface with this versatile, magnetic hanging loop. No drilling required.

Features

- Rugged, metal construction
- Large 2" ID loop
- Magnet: 3-1/4" OD
- Axial holding force of 95 lbs
- Weight 0.6 lbs

Standard Pneumatic Vacuums

Powerful, dependable industrial vacuums with no motors to burn out.





55 Gal. Single Venturi Drum Vacuum Kits

Designed to handle the toughest cleaning jobs, 55 Gallon Single Venturi Drum Vacuums are ideal for vacuuming up chips, dust, debris, liquids or sludges. Powered by compressed air, these vacuums are always dependable and trouble free with no motors or moving parts to wear out. Generate exceptional vacuum lift and vacuum flow while operating quietly and efficiently. High flow (B Venturi) and high lift (D Venturi) versions available. Kit includes popular vacuum attachments and accessories. Factory installed options include: Liquid Shutoff Assembly, HEPA Filtration, and Extra Silent Exhaust.

Features

- Single Venturi vacuum generating head with exhaust silencer
- 55 gallon, 19 gauge steel drum
- Standard cartridge filter
- Air shutoff valve with Universal Coupling
- 3/4" x 20' air supply hose with Universal Couplings
- 20' standard-duty vinyl vacuum hose
- 12" wide metal wet/dry floor tool with 4' steel wand
- Detachable drum dolly with four 3" steel swivel casters

Part No.	Model/Description	Vac Hose Size	Recommended Air Line	Air Flow Required (cfm)	Vacuum Lift (in H ₂ O)	Vacuum Flow (cfm)	Noise (dBA)	Dimensions (L" x W" x H")	Weight (lbs)
N551BC	55 Gallon Vac Kit (B Venturi)	2" ID x 20'	3/4"	68	185	89	100	43.8 x 27.7 x 25.5	100.2
N551BCX	55 Gallon Vac Kit (B Venturi)	1.5" ID x 20'	3/4"	68	185	89	100	43.8 x 27.7 x 25.5	96.0
N551DC	55 Gallon Vac Kit (D Venturi)	1.5" ID x 20'	3/4"	47	213	60	100	43.8 x 27.7 x 25.5	96.0



55 Gal. Dual Venturi Drum Vacuum Kits

Generating 63% more vacuum flow than Single Venturi vacuums. 55 Gallon Dual Venturi Drum Vacuums pick up the heaviest of chips, dust, debris, liquids or sludges, quickly and efficiently. Powered by compressed air, these vacuums are always dependable and trouble free with no motors or moving parts to wear out, and generate exceptional vacuum lift and vacuum flow. Equipped with dual B type Venturis. Kit includes popular vacuum attachments and accessories. Factory installed options include: Liquid Shutoff Assembly, HEPA Filtration and Extra Silent Exhaust.

Features

- Dual Venturi vacuum generating head with exhaust silencer
- 55 gallon, 19 gauge steel drum
- Standard cartridge filter
- Air shutoff valve with Universal Coupling
- 3/4" x 20' air supply hose with Universal Couplings
- 20' standard-duty vinyl vacuum hose
- 12" wide metal wet/dry floor tool with 4' steel wand
- Detachable drum dolly with four 3" steel swivel casters

Part No.	Model/Description	Vac Hose Size	Recommended Air Line	Air Flow Required (cfm)	Vacuum Lift (in H ₂ O)	Vacuum Flow (cfm)	Noise (dBA)	Dimensions (L" x W" x H")	Weight (lbs)
N552BC	55 Gallon Vac Kit (2B Venturi)	2" ID x 20'	3/4"	110	163	163	102	43.8 x 27.7 x 25.5	107.9
N552BCX	55 Gallon Vac Kit (2B Venturi)	1.5" ID x 20'	3/4"	110	163	163	102	43.8 x 27.7 x 25.5	103.7



55 Gal. Single Venturi Vacuum Generating Heads

Mount a Single Venturi Vacuum Generating Head on any standard (23.5" diameter) 55 gallon drum* for instant, high-performance vacuum capability. Ideal for vacuuming up chips, dust, debris, liquids or sludges. Powered by compressed air, these vacuums are always dependable and trouble free with no motors or moving parts to wear out. Single Venturi Vacuum Generating Heads produce exceptional vacuum lift and vacuum flow while operating quietly and efficiently. High flow (B Venturi) and high lift (D Venturi) versions available. Factory installed options include: Liquid Shutoff Assembly, HEPA Filtration and Extra Silent Exhaust.

**19 gauge minimum recommended to prevent drum collapse.*

Features

- Single Venturi vacuum generating head with exhaust silencer
- Standard cartridge filter
- Air shutoff valve with Universal Coupling

Part No.	Model/Description	Vac Hose Inlet	Recommended Air Line	Air Flow Required (cfm)	Vacuum Lift (in H ₂ O)	Vacuum Flow (cfm)	Noise (dBA)	Dimensions (L" x W" x H")	Weight (lbs)
N551B	55 Gallon Vac Head (B Venturi)	For 2" Vac Hose	3/4"	68	185	89	100	25 x 18.8 x 18.8	28.5
N551BX	55 Gallon Vac Head (B Venturi)	For 1.5" Vac Hose	3/4"	68	185	89	100	25 x 18.8 x 18.8	24.3
N551D	55 Gallon Vac Head (D Venturi)	For 1.5" Vac Hose	3/4"	47	213	60	100	25 x 18.8 x 18.8	24.3



55 Gal. Dual Venturi Vacuum Generating Heads

Mount a Dual Venturi Vacuum Generating Head on any standard (23.5" diameter) 55 gallon drum* for instant, high-performance vacuum capability. Generates 63% more vacuum flow than Single Venturi units to pick up the heaviest of materials quickly. Powered by compressed air, these vacuums are always dependable and trouble free with no motors or moving parts to wear out. Dual Venturi Vacuum Generating Heads produce exceptional vacuum lift and vacuum flow while operating quietly and efficiently. Equipped with dual B Venturis. Factory installed options include: Liquid Shutoff Assembly, HEPA Filtration and Extra Silent Exhaust.

**19 gauge minimum recommended to prevent drum collapse.*

Features

- Dual Venturi vacuum generating head with exhaust silencer
- Standard cartridge filter
- Air shutoff valve with Universal Coupling

Part No.	Model/Description	Vac Hose Inlet	Recommended Air Line	Air Flow Required (cfm)	Vacuum Lift (in H ₂ O)	Vacuum Flow (cfm)	Noise (dBA)	Dimensions (L" x W" x H")	Weight (lbs)
N552B	55 Gallon Vac Head (2B Venturi)	For 2" Vac Hose	3/4"	110	163	163	102	27.7 x 24.5 x 22.5	36.2
N552BX	55 Gallon Vac Head (2B Venturi)	For 1.5" Vac Hose	3/4"	110	163	163	102	28 x 21.3 x 21.3	32.0



55 Gal. Single Venturi Vacuum Generating Heads Kits

Mount a Single Venturi Vacuum Generating Head on any standard (23.5" diameter) 55 gallon drum* for instant, high-performance vacuum capability. Ideal for vacuuming up chips, dust, debris, liquids or sludges. Powered by compressed air, these vacuums are always dependable and trouble free with no motors or moving parts to wear out. Single Venturi Vacuum Generating Heads produce exceptional vacuum lift and vacuum flow while operating quietly and efficiently. High flow (B Venturi) and high lift (D Venturi) versions available. Kit includes popular vacuum attachments and accessories. Factory installed options include: Liquid Shutoff Assembly, HEPA Filtration and Extra Silent Exhaust.

*19 gauge minimum recommended to prevent drum collapse.

Features

- Single Venturi vacuum generating head with exhaust silencer
- Standard cartridge filter
- Air shutoff valve with Universal Coupling
- 20' standard-duty vinyl vacuum hose
- Detachable, 12" wide metal wet/dry floor tool with 4' steel wand
- 24" metal crevice tool

Part No.	Model/Description	Vac Hose Size	Recommended Air Line	Air Flow Required (cfm)	Vacuum Lift (in H2O)	Vacuum Flow (cfm)	Noise (dBA)	Dimensions (L" x W" x H")	Weight (lbs)
N551BK	55 Gallon Vac Head Kit (B Venturi)	2" ID x 20'	3/4"	68	185	89	100	25 x 18.8 x 18.8	42.2
N551B XK	55 Gallon Vac Head Kit (B Venturi)	1.5" ID x 20'	3/4"	68	185	89	100	25 x 18.8 x 18.8	38.0
N551DK	55 Gallon Vac Head Kit (D Venturi)	1.5" ID x 20'	3/4"	47	213	60	100	25 x 18.8 x 18.8	38.0



55 Gal. Dual Venturi Vacuum Generating Head Kits

Mount a Dual Venturi Vacuum Generating Head on any standard (23.5" diameter) 55 gallon drum* for instant, high-performance vacuum capability. Generates 63% more vacuum flow than Single Venturi units to pick up the heaviest materials quickly. Powered by compressed air, these vacuums are always dependable and trouble free with no motors or moving parts to wear out. Dual Venturi Vacuum Generating Heads produce exceptional vacuum lift and vacuum flow while operating quietly and efficiently. Equipped with dual B Venturis. Kit includes popular vacuum attachments and accessories. Factory installed options include: Liquid Shutoff Assembly, HEPA Filtration and Extra Silent Exhaust.

*19 gauge minimum recommended to prevent drum collapse.

Features

- Dual Venturi vacuum generating head with exhaust silencer
- Standard cartridge filter
- Air shutoff valve with Universal Coupling
- 20' standard-duty vinyl vacuum hose
- Detachable, 12" wide metal wet/dry floor tool with 4' steel wand
- 24" metal crevice tool

Part No.	Model/Description	Vac Hose Size	Recommended Air Line	Air Flow Required (cfm)	Vacuum Lift (in H2O)	Vacuum Flow (cfm)	Noise (dBA)	Dimensions (L" x W" x H")	Weight (lbs)
N552BK	55 Gallon Vac Head Kit (2B Venturi)	2" ID x 20'	3/4"	110	163	163	102	27.8 x 24.5 x 22.5	50.0
N552B XK	55 Gallon Vac Head Kit (2B Venturi)	1.5" ID x 20'	3/4"	110	163	163	102	27.8 x 24.5 x 22.5	45.7



30 Gal. Drum Vacuum Kits

Designed to handle the toughest of cleaning jobs, Drum Vacuums are ideal for vacuuming up chips, dust, debris, liquids or sludges. Powered by compressed air, these vacuums are always dependable and trouble free with no motors or moving parts to wear out. Drum Vacuums generate exceptional vacuum lift and vacuum flow while operating quietly and efficiently. High flow (B Venturi) and high lift (D Venturi) versions available. Kit includes popular vacuum attachments and accessories. Factory installed options include: Liquid Shutoff Assembly, HEPA Filtration and Extra Silent Exhaust.

Features

- Vacuum generating head with exhaust silencer
- 30 gallon, 18 gauge steel drum
- Standard cartridge filter
- Air shutoff valve with Universal Coupling
- Detachable drum dolly with four, 3" steel swivel casters
- 3/4" x 20' air supply hose with Universal Couplings
- 20' standard-duty vinyl vacuum hose
- 12" wide metal wet/dry floor tool with 4' steel wand

Part No.	Model/Description	Vac Hose Size	Recommended Air Line	Air Flow Required (cfm)	Vacuum Lift (in H2O)	Vacuum Flow (cfm)	Noise (dBA)	Dimensions (L" x W" x H")	Weight (lbs)
N301BC	30 Gallon Vac Kit (B Venturi)	2" ID x 20'	3/4"	68	185	89	100	38.3 x 24 x 23.3	87.6
N301BCX	30 Gallon Vac Kit (B Venturi)	1.5" ID x 20'	3/4"	68	185	89	100	38.3 x 24 x 23.3	83.4
N301DC	30 Gallon Vac Kit (D Venturi)	1.5" ID x 20'	3/4"	47	213	60	100	38.3 x 24 x 23.3	83.4



30 Gal. Vacuum Generating Heads

Mount a Vacuum Generating Head on any standard (19.25" diameter) 30 gallon drum* for instant, high-performance vacuum capability. Ideal for vacuuming up chips, dust, debris, liquids or sludges. Powered by compressed air, these units are always dependable and trouble free with no motors or moving parts to wear out. Vacuum Generating Heads produce exceptional vacuum lift and vacuum flow while operating quietly and efficiently. High flow (B Venturi) and high lift (D Venturi) versions available. Factory installed options include: Liquid Shutoff Assembly, HEPA Filtration and Extra Silent Exhaust. *19 gauge minimum recommended to prevent drum collapse.

Features

- Vacuum generating head with exhaust silencer
- Standard cartridge filter
- Air shutoff valve with Universal Coupling

Part No.	Model/Description	Vac Hose Inlet	Recommended Air Line	Air Flow Required (cfm)	Vacuum Lift (in H2O)	Vacuum Flow (cfm)	Noise (dBA)	Dimensions (L" x W" x H")	Weight (lbs)
N301B	30 Gallon Vac Head (B Venturi)	For 2" Vac Hose	3/4"	68	185	89	100	24 x 23.3 x 17.5	23.8
N301BX	30 Gallon Vac Head (B Venturi)	For 1.5" Vac Hose	3/4"	68	185	89	100	24 x 23.3 x 17.5	19.6
N301D	30 Gallon Vac Head (D Venturi)	For 1.5" Vac Hose	3/4"	47	213	60	100	24 x 23.3 x 17.5	19.6



30 Gal. Vacuum Generating Head Kits

Mount a Vacuum Generating Head on any standard (19.25" diameter) 30 gallon drum* for instant, high-performance vacuum capability. Ideal for vacuuming up chips, dust, debris, liquids or sludges. Powered by compressed air, these vacuums are always dependable and trouble free with no motors or moving parts to wear out. Vacuum Generating Heads produce exceptional vacuum lift and vacuum flow while operating quietly and efficiently. High flow (B Venturi) and high lift (D Venturi) versions available. Kit includes popular vacuum attachments and accessories. Factory installed options include: Liquid Shutoff Assembly, HEPA Filtration and Extra Silent Exhaust. *18 gauge minimum recommended to prevent drum collapse.

Features

- Vacuum generating head with exhaust silencer
- Standard cartridge filter
- Air shutoff valve with Universal Coupling
- 20' standard-duty vinyl vacuum hose
- Detachable, 12" wide metal wet/dry floor tool with 4' steel wand
- 24" metal crevice tool

Part No.	Model/Description	Vac Hose Size	Recommended Air Line	Air Flow Required (cfm)	Vacuum Lift (in H ₂ O)	Vacuum Flow (cfm)	Noise (dBA)	Dimensions (L" x W" x H")	Weight (lbs)
N301BK	30 Gallon Vac Head Kit (B Venturi)	2" ID x 20'	3/4"	68	185	89	100	24 x 23.3 x 17.5	37.5
N301B XK	30 Gallon Vac Head Kit (B Venturi)	1.5" ID x 20'	3/4"	68	185	89	100	24 x 23.3 x 17.5	33.3
N301DK	30 Gallon Vac Head Kit (D Venturi)	1.5" ID x 20'	3/4"	47	213	60	100	24 x 23.3 x 17.5	33.3



20 Gal. Drum Vacuum Kits

20 Gallon Vacuum Kits offer the same high level of performance as our larger units but in a more compact and versatile size. Mobile and easy to maneuver. Perfect for workshops, laboratories, and general maintenance. Ideal for vacuuming up chips, dust, debris, liquids or sludges. Powered by compressed air, always dependable and trouble free with no motors or moving parts to wear out. Generate exceptional vacuum lift and vacuum flow while operating quietly and efficiently. High lift (D Venturi) and medium lift (S Venturi) versions available. Kit includes popular vacuum attachments and accessories. Factory installed options include: Liquid Shutoff Assembly, HEPA Filtration, and Extra Silent Exhaust.

Features

- Vacuum generating head with exhaust silencer
- 20 gallon canister style steel drum with dolly and handle
- Standard cartridge filter
- Air shutoff valve with hose fitting
- 20' air supply hose with fittings
- 20' standard-duty vinyl vacuum hose with cuffs
- 12" wide metal wet/dry floor tool with 4' steel wand
- 24" metal crevice tool

Part No.	Model/Description	Vac Hose Size	Recommended Air Line	Air Flow Required (cfm)	Vacuum Lift (in H ₂ O)	Vacuum Flow (cfm)	Noise (dBA)	Dimensions (L" x W" x H")	Weight (lbs)
N201DC	20 Gallon Vac Kit (D Venturi)	1.5" ID x 20'	3/4"	47	213	60	100	36.3 x 25 x 22	67.0
N201SC	20 Gallon Vac Kit (S Venturi)	1.5" ID x 20'	1/2"	21	105	61	95	36.3 x 25 x 22	67.0



20 Gal. Vacuum Generating Heads

Mount a Vacuum Generating Head on any (19.25" diameter) 20 gallon drum* for instant, high performance vacuum capability. Ideal for vacuuming up chips, dust, debris, liquids or sludges. Powered by compressed air, these units are always dependable and trouble free with no motors or moving parts to wear out. Vacuum Generating Heads produce exceptional vacuum lift and vacuum flow while operating quietly and efficiently. High lift (D Venturi) and medium lift (S Venturi) versions available. Factory installed options include: Liquid Shutoff Assembly, HEPA Filtration, and Extra Silent Exhaust. **18 gauge minimum recommended to prevent drum collapse.*

Features

- Vacuum generating head with exhaust silencer
- Standard cartridge filter
- Air shutoff valve with hose fitting

Part No.	Model/Description	Vac Hose Inlet	Recommended Air Line	Air Flow Required (cfm)	Vacuum Lift (in H ₂ O)	Vacuum Flow (cfm)	Noise (dBA)	Dimensions (L" x W" x H")	Weight (lbs)
N301D	20 Gallon Vac Head (D Venturi)	For 1.5" Vac Hose	3/4"	47	213	60	100	24 x 23.3 x 17.5	23.8
N301S	20 Gallon Vac Head (S Venturi)	For 1.5" Vac Hose	1/2"	21	105	61	95	24 x 23.3 x 17.5	23.8



10 Gal. Vacuum Kits

10 Gallon Kits offer the same high level of performance as larger units but in a more compact package. Lightweight, and portable. Perfect for applications where low drum capacity is sufficient. Ideal for vacuuming up chips, dust, debris, liquids or sludges. Powered by compressed air, always dependable and trouble free with no motors or moving parts to wear out. Generate exceptional vacuum lift and vacuum flow while operating quietly and efficiently. Kit includes popular vacuum attachments and accessories. Factory installed options include: HEPA Filtration.

Features

- Vacuum generating head with exhaust silencer
- 10 gallon canister style steel drum with carry handles
- Standard cartridge filter
- Air shutoff valve with hose fitting
- 20' air hose with fittings (12' for MC)
- 1-1/2" x 20' standard-duty vinyl vacuum hose with cuffs (1-1/4" x 12' for MC)

Part No.	Model/Description	Vac Hose Size	Recommended Air Line	Air Flow Required (cfm)	Vacuum Lift (in H ₂ O)	Vacuum Flow (cfm)	Noise (dBA)	Dimensions (L" x W" x H")	Weight (lbs)
N101DC	10 Gallon Vac Kit (D Venturi)	1.5" ID x 20'	3/4"	47	213	60	100	23.5 x 23 x 17.5	41.1
N101SC	10 Gallon Vac Kit (S Venturi)	1.5" ID x 20'	1/2"	21	105	61	95	23.5 x 23 x 17.5	39.5
N101MC	10 Gallon Vac Kit (M Venturi)	1.25" ID x 10'	3/8"	20	100	56	93	23.5 x 17.5 x 17.5	38.4



10 Gal. Vacuum Generating Heads

Mount a Vacuum Generating Head on a 10 gallon (14 5/8" diameter) drum* for instant, high performance vacuum capability. Ideal for vacuuming up chips, dust, debris, liquids or sludges. Powered by compressed air, these units are always dependable and trouble free with no motors or moving parts to wear out. Vacuum Generating Heads produce exceptional vacuum lift and vacuum flow while operating quietly and efficiently. Factory installed options include: HEPA Filtration.

*20 gauge minimum to prevent drum collapse.

Features

- Vacuum generating head with exhaust silencer
- Standard cartridge filter
- Air shutoff valve with hose fitting

Part No.	Model/Description	Vac Hose Inlet	Recommended Air Line	Air Flow Required (cfm)	Vacuum Lift (in H2O)	Vacuum Flow (cfm)	Noise (dBA)	Dimensions (L" x W" x H")	Weight (lbs)
N101D	10 Gallon Vac Head (D Venturi)	For 1.5" Vac Hose	3/4"	47	213	60	100	23 x 14.8 x 14.4	12.3
N101S	10 Gallon Vac Head (S Venturi)	For 1.5" Vac Hose	1/2"	21	105	61	95	23 x 14.8 x 14.4	12.3
N051M	10 Gallon Vac Head (M Venturi)	For 1.25" Vac Hose	3/8"	20	100	56	93	18.5 x 16.8 x 14.5	11.2



5 Gal. Carry Vac® Kit

5 Gallon Carry Vac Kit offers the same high level of performance as our larger units but in a more compact package. Lightweight, portable. Perfect for applications where low drum capacity is sufficient. Ideal for vacuuming up chips, dust, debris, liquids or sludges. Powered by compressed air, always dependable and trouble free with no motors or moving parts to wear out. Generate exceptional vacuum lift and vacuum flow while operating quietly and efficiently. Equipped with medium lift (M) Venturi and convenient carry handle. Kit includes popular vacuum attachments and accessories. Factory installed options include: HEPA Filtration.

Features

- Vacuum generating head with exhaust silencer
- 5 gallon canister-style steel drum
- Standard cartridge filter
- Air shutoff valve with industrial interchange fitting
- 12' coiled air supply hose with industrial interchange fittings
- 10' standard-duty vinyl vacuum hose with cuffs

Part No.	Model/Description	Vac Hose Size	Recommended Air Line	Air Flow Required (cfm)	Vacuum Lift (in H2O)	Vacuum Flow (cfm)	Noise (dBA)	Dimensions (L" x W" x H")	Weight (lbs)
N051MC	5 Gallon Vac Kit (M Venturi)	1.25" ID x 10'	3/8"	20	100	56	93	18.5 x 18.5 x 14.5	20.1

Specialty Vacuum Systems

Wall-mounted and specialized vacuum solutions.





MachineVac

Running off standard shop compressed air, the powerful, 5.5 gallon MV2000 Pneumatic Vacuum quickly and effectively sucks up debris, metal chips, dirt, sawdust, and fine materials including powders and talc. Also capable of vacuuming liquids such as machine oils, lubricants, and other fluids. Virtually maintenance-free; no moving parts to wear out. With no electric motor to spark or burn out, the MachineVac eliminates electrical extension cords — potentially dangerous in wet environments and always a tripping hazard. Engineered to mount on any vertical surface, saving valuable factory floor space.

Features

- 5.5 gallon chemical resistant polyethylene container
- Pre-drilled, steel plate for vertical mounting
- Cartridge filter (77% efficient @ 0.8 microns)
- Liquid shut-off and drum drain
- 1-1/2" ID x 10' flexible vacuum hose
- 1-1/2" OD x 11" plastic crevice tool
- 3/8" FNPT inlet

Part No.	Model/Description	Recommended Air Line	Air Flow Required (cfm)	Vacuum Lift (in H2O)	Vacuum Flow (cfm)	Noise (dBA)	Dimensions (L" x W" x H")	Weight (lbs)
MV2000	MachineVac	3/8"	21	77	73	85	17 x 12.5 x 21.8	20.6



Personnel Cleaning Station

Eliminate the dangerous practice of self cleaning with blow guns. Running off standard shop compressed air, the Personnel Cleaning Station pairs a proprietary, on-demand air-agitator brush attachment with a high-efficiency pneumatic vacuum. Thumb-switch activated, the air-agitator loosens and lifts particles airborne where the vacuum sucks them away safely and effectively. With no motor to burn out, the Personnel Cleaning Station is virtually maintenance-free. Mounts on any vertical surface, saving valuable factory floor space. Meets OSHA Standards.

Features

- 5.5 gallon chemical resistant polyethylene container
- Pre-drilled, steel plate for vertical mounting
- Cartridge filter (77% efficient @ 0.8 microns)
- Liquid shut-off and drum drain
- 1-1/4" ID x 5' flexible vacuum hose
- 3/8" FNPT inlet

Part No.	Model/Description	Recommended Air Line	Air Flow Required (cfm)	Vacuum Lift (in H2O)	Vacuum Flow (cfm)	Noise (dBA)	Dimensions (L" x W" x H")	Weight (lbs)
CS3000	Personnel Cleaning Station	3/8"	33	77	73	88	17 x 12.5 x 21.8	20.6



Blind Hole Vacuum

Incorporating pneumatic vacuum technology, the Blind Hole Vacuum is designed to safely and effectively suck up debris normally trapped in blind holes. Eliminates dangerous chip fly-back and extra cleanup generated by simply blowing out debris. Powered by standard shop compressed air, the BH4000 features a powerful pneumatic vacuum paired with an on-demand air-agitator that loosens and lifts chips or debris lying deep within crevices or blind holes. Clear-view window ensures precision positioning for maximum performance, and the 5' vacuum hose provides flexible reach. Capable of mounting on any vertical surface, the versatile Blind Hole Vacuum is equipped with a 5.5 gallon, chemical resistant container and a standard air filter.

Features

- 5.5 gallon, polyethylene container
- Standard air filter (77% efficient @ 0.8 microns)
- Air-agitator/brush attachment with clear-view window
- 1-1/4" ID x 5' flexible vacuum hose
- Pre-drilled, steel plate for vertical mounting
- 3/8" FNPT inlet

Part No.	Model/Description	Recommended Air Line	Air Flow Required (cfm)	Vacuum Lift (in H ₂ O)	Vacuum Flow (cfm)	Noise (dBA)	Dimensions (L" x W" x H")	Weight (lbs)
BH4000	Blind Hole Vacuum	3/8"	33	77	73	92	17 x 12.5 x 21.8	20.6



Material Mover® Kit

Powered by compressed air, the Material Mover is a portable, in-line vacuum system developed to transport materials from point A to point B. Featuring a 2.5" diameter throat, the lightweight, easy-to-handle Material Mover is ideal for moving seed, grains, corn, beans, plastic pellets, or other dry materials. Perfect for cleaning out agricultural equipment including combines and seeders or moving material into storage bins or silos. Minimizes damage to transported materials and reduces waste. No moving parts or motor to burn out. Available in two versions; 4 Nozzle (83 cfm) designed for 100 cfm compressors, and 8 Nozzle (165 cfm) for 185 cfm compressors.

Features

- Rugged, aluminum and steel components
- Adjustable output deflector
- Versatile, steel cradle
- 15' x 2-1/2" diameter flexible vacuum hose
- 4' polycarbonate vacuum wand
- 3/4" Universal Coupling

Part No.	Model/Description	Air Inlet FNPT (in)	Recommended Compressor Size (cfm)	Vacuum Lift (in H ₂ O)	Vacuum Flow (cfm)	Noise (dBA)	Dimensions (L" x W" x H")	Weight (lbs)
MM400	Vacuum Unit (4 Nozzle, 83 cfm)	3/4"	100	33	360	110	20.2 x 5 x 8.2	8.9
MM450	Basic Kit Includes MM400, Vacuum Hose, Vacuum Wand	3/4"	100	33	360	110	20.2 x 5 x 8.2	16.5
MM460	Complete Kit Includes MM400, Vacuum Hose, Vacuum Wand, Cradle, Deflector	3/4"	100	33	360	110	23.2 x 20.2 x 30.5	28.7
MM800	Vacuum Unit (8 Nozzle, 165 cfm)	3/4"	185	62	491	112	20.2 x 5 x 8.2	8.9
MM850	Basic Kit Includes MM800, Vacuum hose, Vacuum Wand	3/4"	185	62	491	112	20.2 x 5 x 8.2	16.5
MM860	Complete Kit Includes MM800, Vacuum Hose, Vacuum Wand, Cradle, Deflector	3/4"	185	62	491	112	23.2 x 20.2 x 30.5	28.7

Static Conductive Pneumatic Vacuums

Vacuums that suppress static charge build up.





55 Gal. Drum Vacuum Kits Static Conductive - Single Venturi

Single Venturi Static Conductive Pneumatic Vacuums eliminate static electricity by incorporating interconnected conductive components to suppress stray static electricity. Powered by compressed air, with no motors to spark or burnout, and no electric cords, Static Conductive Vacuums generate exceptional vacuum lift and vacuum flow, and offer safe, effective, efficient performance. Kit includes popular vacuum attachments and accessories. Factory installed options include: Liquid Shutoff Assembly, HEPA Filtration and Extra Silent Exhaust.

Features

- 55 gallon steel drum with static conductive lid
- Standard cartridge filter
- Air shutoff valve with Universal Coupling
- Grounding lug with optional grounding cable assembly
- Detachable drum dolly; swivel casters with 3" steel wheels
- 3/4" x 20' static conductive air hose with Universal Couplings
- 20' static conductive vacuum hose with metal wet/dry floor tool
- 24" metal crevice tool

Part No.	Model/Description	Vac Hose Size	Recommended Air Line	Air Flow Required (cfm)	Vacuum Lift (in H2O)	Vacuum Flow (cfm)	Noise (dBA)	Dimensions (L" x W" x H")	Weight (lbs)
N551BCNED	55 Gallon NED Vac Kit (B Venturi)	2" ID x 20'	3/4"	68	185	89	100	43.8 x 27.7 x 25.5	100.2
N551BCXNED	55 Gallon NED Vac Kit (B Venturi)	1.5" ID x 20'	3/4"	68	185	89	100	43.8 x 27.7 x 25.5	96.0
N551DCNED	55 Gallon NED Vac Kit (D Venturi)	1.5" ID x 20'	3/4"	47	213	60	100	43.8 x 27.7 x 25.5	96.0



55 Gal. Drum Vacuum Kits Static Conductive - Dual Venturi

Generating 63% more vacuum flow than single Venturi units, Dual Venturi Static Conductive Drum Vacuums are designed to operate safely in many locations where static electricity discharge is a concern. Static conductive components, and multiple grounding options eliminate static charges at the source. Powered by compressed air, with no motors to spark or burnout, and no electric cords, Static Conductive Vacuums generate exceptional vacuum lift and vacuum flow, and offer safe, effective, efficient performance. Equipped with dual B type Venturis. Kit includes popular vacuum attachments and accessories. Factory installed options include: Liquid Shutoff Assembly, HEPA Filtration and Extra Silent Exhaust.

Features

- 55 gallon steel drum with static conductive lid
- Standard cartridge filter
- Air shutoff valve with Universal Coupling
- Grounding lug with optional cable assembly
- Detachable drum dolly; swivel casters with 3" steel wheels
- 3/4" x 20' static conductive air hose with Universal Couplings
- 20' static conductive vacuum hose with metal wet/dry floor tool
- 24" metal crevice tool

Part No.	Model/Description	Vac Hose Size	Recommended Air Line	Air Flow Required (cfm)	Vacuum Lift (in H2O)	Vacuum Flow (cfm)	Noise (dBA)	Dimensions (L" x W" x H")	Weight (lbs)
N552BCNED	55 Gallon NED Vac Kit (2B Venturi)	2" ID x 20'	3/4"	110	163	163	102	48 x 27.7 x 24.5	107.9
N552BCXNED	55 Gallon NED Vac Kit (2B Venturi)	1.5" ID x 20'	3/4"	110	163	163	102	48 x 27.7 x 24.5	103.7



30 Gal. Drum Vacuum Kits Static Conductive

30 Gallon Static Conductive Drum Vacuums are ideal for vacuuming up chips, dust, debris, liquids, or sludges in locations where static electricity discharge is a concern. Static conductive components, attachments and multiple grounding options eliminate static charges at the source. Powered by compressed air, with no motors to spark or burnout, and no electric cords, Static Conductive Vacuums generate exceptional vacuum lift and vacuum flow, and offer safe, effective, efficient performance. High flow (B Venturi) and high lift (D Venturi) versions available. Kit includes popular vacuum attachments and accessories. Factory installed options include: Liquid Shutoff Assembly, HEPA Filtration and Extra Silent Exhaust.

Features

- 30 gallon steel drum with static conductive lid
- Standard cartridge filter
- Air shutoff valve with Universal Coupling
- Grounding lug with optional grounding cable assembly
- Heavy-duty, static conductive powder coated, 30 gallon steel drum
- Detachable drum dolly; swivel casters with 3" steel wheels
- 3/4" x 20' static conductive air hose with Universal Couplings
- 20' static conductive vacuum hose with metal wet/dry floor tool
- 24" metal crevice tool

Part No.	Model/Description	Vac Hose Size	Recommended Air Line	Air Flow Required (cfm)	Vacuum Lift (in H2O)	Vacuum Flow (cfm)	Noise (dBA)	Dimensions (L" x W" x H")	Weight (lbs)
N301BCNED	30 Gallon NED Vac Kit (B Venturi)	2" ID x 20'	3/4"	68	185	89	100	38.3 x 24 x 23.3	83.4
N301BCXNED	30 Gallon NED Vac Kit (B Venturi)	1.5" ID x 20'	3/4"	68	185	89	100	38.3 x 24 x 23.3	83.4
N301DCNED	30 Gallon NED Vac Kit (D Venturi)	1.5" ID x 20'	3/4"	47	213	60	100	38.3 x 24 x 23.3	87.6



20 Gal. Drum Vacuum Kits Static Conductive

Powered by compressed air, 20 Gallon Static Conductive Drum Vacuums are ideal for vacuuming up chips, dust, debris, liquids, or sludges in locations where static electricity discharge is a concern. Static conductive components, attachments, and multiple grounding options eliminate static charges at the source. Powered by compressed air with no motors to spark or burnout, and no electric cords, Static Conductive Vacuums generate exceptional vacuum lift and vacuum flow. High flow (B Venturi) and high lift (D Venturi) versions available. Kit includes popular vacuum attachments and accessories. Factory installed options include: Liquid Shutoff Assembly, HEPA Filtration, and Extra Silent Exhaust.

Features

- 20 gallon steel drum with static conductive lid
- Standard cartridge filter
- Air shutoff valve with hose fitting
- Grounding lug with optional grounding cable assembly
- 20' static conductive air hose with fittings
- 20' static conductive vacuum hose with metal wet/dry floor tool
- 24" metal crevice tool

Part No.	Model/Description	Vac Hose Size	Recommended Air Line	Air Flow Required (cfm)	Vacuum Lift (in H2O)	Vacuum Flow (cfm)	Noise (dBA)	Dimensions (L" x W" x H")	Weight (lbs)
N201DCNED	20 Gallon NED Vac Kit (D Venturi)	1.5" ID x 20'	3/4"	47	213	60	100	36.3 x 25 x 22	67.0
N201SCNED	20 Gallon NED Vac Kit (S Venturi)	1.5" ID x 20'	1/2"	21	105	61	95	36.3 x 25 x 22	67.0



MachineVac Static Conductive

Powered by standard shop compressed air, the powerful MachineVac NED (Non-Electrical Discharge) quickly and effectively vacuums up dry and wet materials to keep your workspace clean. Constructed from electrically conductive components, the MachineVac NED suppresses the buildup of static charges for safe use with combustible materials commonly found in manufacturing, chemical, and food processing facilities. Static conductive vacuum and air supply hose insure static suppression. With no electric motor to burn out, the MachineVac NED is virtually maintenance-free. Includes mounting plate for mounting the unit on vertical surfaces, thereby saving valuable floor space. Grounding lug provides extra degree of safety.

Features

- 5.5 gallon, static conductive polyethylene container
- Standard cartridge filter (77% efficient @ 0.8 microns)
- Bottom drain plug
- Pre-drilled, steel vertical mounting plate
- 1-1/2" ID x 10' static conductive vacuum hose
- Aluminum crevice tool
- 3/8" ID x 20' static conductive air hose
- Shutoff valve with 3/8" FNPT inlet

Part No.	Model/Description	Recommended Air Line	Air Flow Required (cfm)	Vacuum Lift (in H2O)	Vacuum Flow (cfm)	Noise (dBA)	Dimensions (L" x W" x H")	Weight (lbs)
MV2000NED	MachineVac NED	3/8"	21	77	73	85	17 x 12.5 x 21.8	20.6



Personnel Cleaning Station Static Conductive

Eliminate the dangerous practice of self-cleaning with blow guns. Powered by standard shop compressed air, the Personnel Cleaning Station NED (Non-Electrical Discharge) quickly vacuums dust, powders, and chips off worker clothing and skin. Pairing a high-efficiency pneumatic vacuum with a proprietary, air-agitator brush attachment, the Personnel Cleaning Station NED is safe and effective. Thumb switch activated, the air-agitator loosens and lifts particles airborne into the vacuum hose for transport to the container. Constructed from electrically conductive components, the Personnel Cleaning Station NED suppresses the buildup of static charges for safe use with combustible materials commonly found in manufacturing, chemical, and food processing facilities. Static conductive vacuum and air supply hose insure static suppression. Grounding lug provides extra degree of safety.

Features

- 5.5 gallon, static conductive polyethylene container
- Standard cartridge filter (77% efficient @ 0.8 microns)
- Static conductive, air-agitator brush attachment
- Pre-drilled, steel vertical mounting plate
- 1-1/4" ID x 5' static conductive vacuum hose
- 3/8" ID x 20' static conductive air hose
- Shutoff valve with 3/8" FNPT inlet

Part No.	Model/Description	Recommended Air Line	Air Flow Required (cfm)	Vacuum Lift (in H2O)	Vacuum Flow (cfm)	Noise (dBA)	Dimensions (L" x W" x H")	Weight (lbs)
CS3000NED	Personnel Cleaning Station NED	3/8"	33	77	73	88	17 x 12.5 x 21.8	20.6

Material Mover® Kit Static Conductive

Powered by compressed air, the Material Mover Static Conductive is a portable, in-line vacuum system developed to transport materials from point A to point B. Featuring a 2.5" diameter throat, the lightweight, easy-to-handle Material Mover Static Conductive is ideal for moving seed, grains, corn, beans, plastic pellets, or other dry materials. Perfect for cleaning out agricultural equipment including combines and seeders, or moving material into storage bins or silos. Minimizes damage to transported materials and reduces waste. No moving parts or motor to burn out. Static conductive vacuum hose and aluminum vacuum wand eliminate static electricity at the source. Available in two versions; 4 Nozzle (83 cfm) designed for 100 cfm compressors and 8 Nozzle (165 cfm) for 185 cfm compressors.

Features

- Rugged, aluminum and steel components
- Adjustable output deflector
- Versatile, steel cradle
- 15' x 2-1/2" diameter flexible static conductive vacuum hose
- 5' aluminum vacuum wand
- 3/4" Universal Coupling



Part No.	Model/Description	Air Inlet FNPT (in)	Recommended Compressor Size (cfm)	Vacuum Lift (in H ₂ O)	Vacuum Flow (cfm)	Noise (dBA)	Dimensions (L" x W" x H")	Weight (lbs)
MM450NED	Basic Kit includes MM400, Static Conductive Vacuum Hose, Aluminum Vacuum Wand	3/4"	100	33	360	110	20.2 x 5 x 8.2	17.2
MM460NED	Complete Kit includes MM400, Static Conductive Vacuum Hose, Aluminum Vacuum Wand, Cradle, Deflector	3/4"	100	33	360	110	23.2 x 20.2 x 30.5	29.4
MM850NED	Basic Kit includes MM800, Static Conductive Vacuum Hose, Aluminum Vacuum Wand	3/4"	185	62	491	112	20.2 x 5 x 8.2	17.2
MM860NED	Complete Kit includes MM800, Static Conductive Vacuum Hose, Aluminum Vacuum Wand, Cradle, Deflector	3/4"	185	62	491	112	23.2 x 20.2 x 30.5	29.4

Hazardous Location Pneumatic Vacuums

ATEX certified for use in hazardous locations.





55 Gal. Drum Vacuum Kits Hazardous Location - Single Venturi

ATEX certified, 55 Gallon Single Venturi Hazardous Location Drum Vacuums are ideal for vacuuming up chips, dust, debris, liquids, or sludges in hazardous locations. Electrically bonded components, static conductive attachments, and multiple grounding options eliminate static electricity at the source. Powered by compressed air, with no motors to spark or burnout, and no electric cords, Hazardous Location Vacuums generate exceptional vacuum lift and flow, and offer safe, effective, efficient performance. High flow (B Venturi) and high lift (D Venturi) versions available. Factory installed options include: Liquid Shutoff Assembly, HEPA Filtration, and Extra Silent Exhaust.

Features

- 55 gallon steel drum with static conductive lid
- Standard cartridge filter with electrically conductive cage
- Air shutoff valve with Universal Coupling
- Grounding lug with optional grounding cable assembly
- Detachable drum dolly; swivel casters with 3" steel wheels
- 3/4" x 20' static conductive air hose with Universal Couplings
- 20' static conductive vacuum hose with metal wet/dry floor tool
- 24" metal crevice tool

Part No.	Model/Description	Vac Hose Size	Recommended Air Line	Air Flow Required (cfm)	Vacuum Lift (in H2O)	Vacuum Flow (cfm)	Noise (dBA)	Dimensions (L" x W" x H")	Weight (lbs)
N551BCATEX	55 Gallon ATEX Vac Kit (B Venturi)	2" ID x 20'	3/4"	68	185	89	100	43.8 x 27.7 x 25.5	100.2
N551BCXATEX	55 Gallon ATEX Vac Kit (B Venturi)	1.5" ID x 20'	3/4"	68	185	89	100	43.8 x 27.7 x 25.5	96.0
N551DCATEX	55 Gallon ATEX Vac Kit (D Venturi)	1.5" ID x 20'	3/4"	47	213	60	100	43.8 x 27.7 x 25.5	96.0



55 Gal. Drum Vacuum Kits Hazardous Location - Dual Venturi

Generating 63% more vacuum flow than single Venturi units, 55 Gallon Dual Venturi Hazardous Location Drum Vacuums are designed to operate safely in many hazardous locations. ATEX certified safe. Electrically bonded components, static conductive attachments, and multiple grounding options eliminate static electricity at the source. Powered by compressed air, with no motors to spark or burnout, and no electric cords, Hazardous Location Vacuums generate exceptional vacuum lift and flow, and offer safe, effective, efficient performance. Equipped with dual B Venturis. Factory installed options include: Liquid Shutoff Assembly, HEPA Filtration and Extra Silent Exhaust.

Features

- 55 gallon steel drum with static conductive lid
- Standard cartridge filter with electrically conductive cage
- Air shutoff valve with Universal Coupling
- Grounding lug with optional grounding cable assembly
- Detachable drum dolly; swivel casters with 3" steel wheels
- 3/4" x 20' static conductive air hose with Universal Couplings
- 20' static conductive vacuum hose with metal wet/dry floor tool
- 24" metal crevice tool

Part No.	Model/Description	Vac Hose Size	Recommended Air Line	Air Flow Required (cfm)	Vacuum Lift (in H2O)	Vacuum Flow (cfm)	Noise (dBA)	Dimensions (L" x W" x H")	Weight (lbs)
N552BCATEX	55 Gallon ATEX Vac Kit (2B Venturi)	2" ID x 20'	3/4"	110	163	163	102	48 x 27.7 x 24.5	107.9
N552BCXATEX	55 Gallon ATEX Vac Kit (2B Venturi)	1.5" ID x 20'	3/4"	110	163	163	102	48 x 27.7 x 24.5	103.7



30 Gal. Drum Vacuum Kits Hazardous Location

ATEX certified, 30 Gallon Hazardous Location Drum Vacuums are ideal for vacuuming up chips, dust, debris, liquids, or sludges in many hazardous locations. Electrically bonded components, static conductive attachments, and multiple grounding options eliminate static electricity at the source. Powered by compressed air, with no motors to spark or burnout, and no electric cords, Hazardous Location Vacuums generate exceptional vacuum lift and vacuum flow, and offer safe, effective, efficient performance. High flow (B Venturi) and high lift (D Venturi) versions available. Kit includes popular vacuum attachments and accessories. Factory installed options include: Liquid Shutoff Assembly, HEPA Filtration, and Extra Silent Exhaust.

Features

- 30 gallon steel drum with static conductive lid
- Heavy-duty, static conductive powder coated, 30 gallon steel drum
- Standard cartridge filter with electrically conductive cage
- Air shutoff valve with Universal Coupling
- Grounding lug with optional grounding cable assembly
- Detachable drum dolly; swivel casters with 3" steel wheels
- 3/4" x 20' static conductive air hose with Universal Couplings
- 20' static conductive vacuum hose with metal wet/dry floor tool
- 24" metal crevice tool

Part No.	Model/Description	Vac Hose Size	Recommended Air Line	Air Flow Required (cfm)	Vacuum Lift (in H ₂ O)	Vacuum Flow (cfm)	Noise (dBA)	Dimensions (L" x W" x H")	Weight (lbs)
N301BCATEX	30 Gallon ATEX Vac Kit (B Venturi)	2" ID x 20'	3/4"	68	185	89	100	38.3 x 24 x 23.3	87.6
N301BCXATEX	30 Gallon ATEX Vac Kit (B Venturi)	1.5" ID x 20'	3/4"	68	185	89	100	38.3 x 24 x 23.3	83.4
N301DCATEX	30 Gallon ATEX Vac Kit (D Venturi)	1.5" ID x 20'	3/4"	47	213	60	100	38.3 x 24 x 23.3	87.6

Hand-held Pneumatic Vacuums

Convenience & twice the power of standard shop vacuums.





GunVac®

Twice the power of a standard shop vacuum in the palm of your hand. Powered by standard shop compressed air, the lightweight 1500 GunVac has no electric motors to burn out. Easy to empty, high filtration collection bag attaches to rear of vacuum via hose cuff. Tapered vacuum inlet accepts all standard 1-1/4" vac accessories. Unit hangs on a hook, ready for use at any time.

Features

- Rugged, all metal construction
- Contoured comfort grip
- Convenient hanging eyelet
- High filtration collection bag with zipper
- 9" crevice tool included
- 1/4" FNPT bottom and rear inlets

Part No.	Model/Description	Air Inlet FNPT (in)	Min. Compressor Required (hp)	Air Flow Required (cfm)	Vacuum Flow (cfm)	Vacuum Lift (in H2O)	Noise (dBA)	Dimensions (L" x W" x H")	Weight (lbs)
1500	GunVac Kit	1/4	6.4	29	78	75	89	30.5 x 1.5 x 8	1.8



GunVac® Deluxe Kit

Twice the power of a standard shop vacuum in the palm of your hand. Powered by standard shop compressed air, the lightweight 1510 GunVac has no electric motors to burn out. Easy to empty, high filtration collection bag attaches to rear of vacuum via hose cuff. Tapered vacuum inlet accepts all standard 1-1/4" vac accessories (5 included). Unit hangs on a hook, ready for use at any time.

Features

- GunVac with all metal construction
- Contoured comfort grip
- Convenient hanging eyelet
- High filtration collection bag with zipper
- 5 piece plastic accessory kit included
- 1/4" FNPT bottom and rear inlets

Part No.	Model/Description	Air Inlet FNPT (in)	Min. Compressor Required (hp)	Air Flow Required (cfm)	Vacuum Flow (cfm)	Vacuum Lift (in H2O)	Noise (dBA)	Dimensions (L" x W" x H")	Weight (lbs)
1510	GunVac Deluxe Kit	1/4	6.4	29	78	75	89	30.5 x 1.5 x 8	2.5



Flexible GunVac®

Twice the power of a standard shop vacuum in the palm of your hand. Powered by standard shop compressed air, the lightweight 1548 Flexible GunVac has no electric motors to burn out. Easy to empty high filtration collection bag attaches to rear of vacuum via hose cuff. Unit hangs on a hook, ready for use at any time. Threaded vacuum inlet accepts 18" x 1-5/16" OD flexible metal extension (included).

Features

- Rugged, all metal construction
- Contoured comfort grip
- Convenient hanging eyelet
- High filtration collection bag with zipper
- 18" x 1-5/16" O.D. Flexible metal extension
- 1/4" FNPT bottom and rear inlets

Part No.	Model/Description	Air Inlet FNPT (in)	Min. Compressor Required (hp)	Air Flow Required (cfm)	Vacuum Flow (cfm)	Vacuum Lift (in H ₂ O)	Noise (dBA)	Dimensions (L" x W" x H")	Weight (lbs)
1548	Flexible GunVac	1/4	6.4	29	78	75	89	39.5 x 1.5 x 8	2.2

GUNVAC ACCESSORIES & REPLACEMENT PARTS



1500A02

High Filtration Collection Bag

1500 1510 1548

• • •



1400A03

Round Bristle Brush

• •



1400A05-1

18" Curved Aluminum Extension - 1/2" OD, 90° Angle

• •



1400E018-1

18" Straight Aluminum Extension - 1/2" OD

• •



1448F018

18" Flexible Metal Extension

•



1400A15

1-1/4" ID Flexible PVC Hose - Mates with (1400A16) Hose Cuff

• • •



1400A16

1-1/4" ID Inlet/Outlet PVC Hose Cuff - Mates with (1400A15) Hose

• • •



N849

9" PVC Crevice Tool

•



1410A04

12" PVC Crevice Tool

• •



1410A03

Fiber Bristle Brush Tip - Mates with (1410A04) 12" PVC Crevice Tool

• •



1410A06

Upholstery/Clothes Tool - With dual lint pads

• •



1410A08

Swivel Brush

• •



1410A10

7" Universal Elongated Brush

• •



14VA01

24" - 40" Telescoping Extension - Chrome Plated

• •



14VA02

19" PVC Extension

• •



14VA03

4" Diameter Curved Pipe Cleaning Tool

• •



14VA05

Hand-Held Turbo Brush - For hard floors, upholstery, and carpets

• •



14VA07

12" Floor Brush - With 1-1/4" Poly Bristle

• •



14VA09

Heavy-Duty Flat Utility Tool - Gulper orifice 3-1/2" x 1/2"

• •



14VA10

Combination Floor Brush - Switches from metal base to a poly bristle brush base

• •



MNVAC

Mini Vacuum Attachment Kit - Includes 36" flexible plastic tube with universal adapter, curved extension, straight extension, round brush, oval brush, and crevice tool.

• •



74PK01

Valve Repair Kit

• • •



WARNING: Cancer and Reproductive Harm-www.P65Warnings.ca.gov.

Vacuum Parts & Accessories





Cartridge Filters

Standard Cartridge Filters – Our most popular filter, the Standard Cartridge Filter is ideal for most industrial and commercial applications. Operates at a minimum of 98% efficiency for particles up to 10 microns

HEPA Cartridge Filters – Capable of capturing particles invisible to the naked eye, HEPA (High Efficiency Particulate Air) Cartridge Filter meets industry standards for HEPA air filtration - 99.98% efficiency for particles up to 0.3 microns. Ideal for working with allergens, powders, and superfine particles. Comes with cloth pre-filter bag.

ULPA Cartridge Filters – Capable of capturing the most minute particles, ULPA (Ultra Low Penetration Air) Cartridge Filter meets the highest industry standards for air filtration - 99.97% efficiency for particles up to 0.1 microns. Ideal for working with allergens, mold, pollen, superfine powders, etc. Cloth pre-filter bag provides extra stage of filtration extending the life of the cartridge filter.

Part No.	Description	Models	Figure
N635	Cartridge Filter - Standard	55/30/20 Gal. Vacs	A
N635PK	Cartridge Filter - Standard (6pk)	55/30/20 Gal. Vacs	A
N635H	Cartridge Filter - HEPA*	55/30/20 Gal. Vacs	A
N635U	Cartridge Filter - ULPA*	55/30/20 Gal. Vacs	A
N635ATEX	ATEX Cartridge Filter - Standard	55/30 Gal. ATEX Vacs	B
N635HATEX	ATEX Cartridge Filter - HEPA*	55/30 Gal. ATEX Vacs	B
N635UATEX	ATEX Cartridge Filter - ULPA*	55/30 Gal. ATEX Vacs	B
MV2000F1	Small Cartridge Filter - Standard	MV2000, CS3000, BH4000, 10/5 Gal. Vacs	C
MV2000F2	Small Cartridge Filter - HEPA	MV2000, CS3000, BH4000, 10/5 Gal. Vacs	C

*Includes pre-filter bag (N635B)

NOTE: ATEX models feature bonding cable for electrical conductivity



Cartridge Filter Retaining Springs

Provides safe, secure method of mounting cartridge filter or Liquid Shutoff Assembly to underside of vacuum drum cover. For use with all 55, 30, and 20 Gallon Drum Vacuums and Vacuum Generating Heads.

Part No.	Description
N6603	Filter Retaining Springs (3pk)



Cloth Pre-Filter Bag

Extend the life of cartridge filters. Cotton flannel bag installs over Standard, HEPA, and ULPA cartridge filters providing extra stage of filtration. Prevents wear and tear by capturing larger particles before they reach the cartridge filter. Washable and reusable.

Part No.	Description
N635B	Cloth Pre-Filter Bag



Exhaust Housing

Part No.	Description	Models
N685	Exhaust Housing w/ Endcap	For B/D/S Venturi
N885	Exhaust Housing w/ Endcap	For M Venturi
N685C	Replacement Endcap	For B/D/S/M Venturi

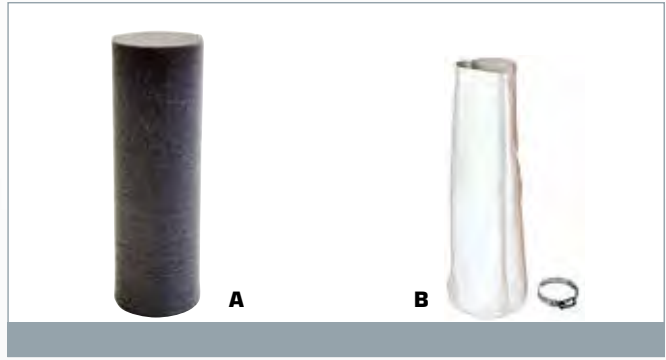

Exhaust Silencer Insert

Part No.	Description	Models	Figure
N686	Silencer Foam Insert	B/D/S Venturi	A
N886	Silencer Foam Insert	M Venturi	A
MV2000EB	Silencer Bag	MV2000, CS3000, BH4000	B



Extra-Silent Exhaust Assembly

Where quiet operation is important, the Extra-Silent Exhaust Assembly reduces vacuum noise levels by 8 to 16 decibels. Fits atop all 55, 30, and 20 gallon Guardair vacuums. Available as stand-alone item or factory installed option.

Part No.	Description
N710	Extra Silent Exhaust Assembly
N712	Extra Silent Exhaust Housing Only



Extra-Silent Exhaust Foam Insert

Part No.	Description
N711	Extra Silent Exhaust Foam Insert (2pc.)



Vacuum Maintenance Kits

Everything necessary to keep Guardair vacuum units running smoothly and efficiently. Maintenance kits include standard cartridge filter; cloth pre-filter bag, drum cover gasket, exhaust silencer foam insert, filter retaining springs, & mounting hardware.

Part No.	Model/Description
NMK55	For 55 Gallon Vacuums
NMK30	For 30 & 20 Gallon Vacuums

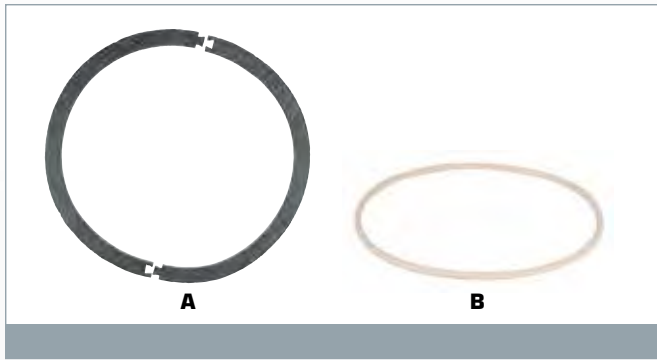

Drum Cover and Lid Gaskets

Part No.	Description	Models	Figure
MV2000G	Neoprene Lid Gasket	For MV2000, CS3000, BH4000	A
N656	Neoprene Lid Gasket	For 55 Gal. Vacs	A
N655	Neoprene Lid Gasket	For 30/20 Gal. Vacs	A
N657	Natural Rubber Lid Gasket	For 10/5 Gal. Vacs	B

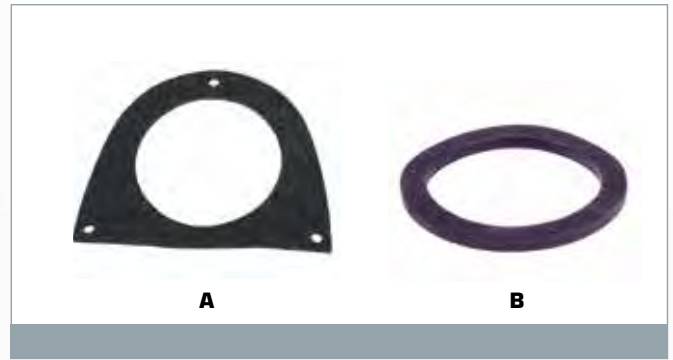

Misc. Gaskets

Part No.	Description	Models	Figure
N682	Venturi Box Gasket	For 55/30/20/10/5 Gal. Vacs	A
N664	Inlet Elbow Gasket	For 55/30/20 Gal. Vacs	B



Liquid Drain Valve

Features rugged, cast iron, liquid drain valve with stainless steel-plated, wire-mesh inlet screen. Ideal for straining and dispensing heavy oils, light grease, food products and other non-flammable, viscous liquids from vacuum drums. Lapped brass face plate provides smooth operation and a perfect seal, while a sturdy, two-inch metal handle offers optimum flow control. Inlet threads into the bunghole of 55, 30, and 20 gallon drums. Can be padlocked.

Part No.	Description
N645	Liquid Drain Valve w/ Strainer
N620	Liquid Drain Valve Only



Liquid Shutoff Assembly

Limits intake of vacuumed fluids when drum is full, preventing damage to exhaust silencer(s). Replaces standard (dry) cartridge filter. Available as stand-alone item or factory installed option. Fits 55, 30, and 20 gallon Vacuum Units and Vacuum Generating Heads.

Part No.	Description
N638	Liquid Shut-Off Assembly
N6381	Replacement Float Ball
N6382	Replacement Wire Cage



Steel Drums

Durable, heavy-duty steel drum is ideal for capturing and storing wet or dry vacuumed materials. Epoxy/phenolic coated interior surface is resistant to chipping or peeling and provides corrosion protection to caustic materials. ATEX models feature side latches to secure lid to drum.

Part No.	Model/Description	Steel Gauge
N650	55 Gallon Drum	19
N650ATEX	55 Gallon Drum for ATEX Model Vacs	19
N630	30 Gallon Drum	18
N630ATEX	30 Gallon Drum for ATEX Model Vacs	18
N200	20 Gallon Drum	18
N100	10 Gallon Drum	20
N050	5 Gallon Drum	20

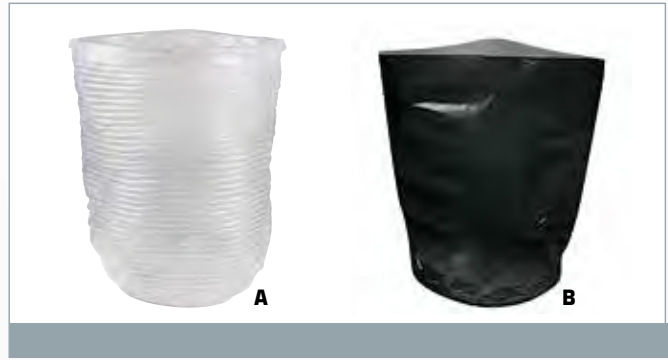

Disposable Drum Liners

Disposable, liquid-tight plastic drum liners allow complete recovery of wet or dry vacuumed product. 8-millimeter polyethylene film features heat-sealed seams for strong, contoured fit. Rounded bottom, minimizes wrinkles and folds, reducing stress. FDA-compliant material for food processing applications. Easy to install. Simply twist and tie-off to protect contents.

NED Drum Liners Made from conductive black polyethylene, these liners are perfect for applications where static buildup is a concern.

Part No.	Model/Description	Figure
N650PB	55 Gallon Drum Liners (10pk)	A
N630PB	30 Gallon Drum Liners (10pk)	A
N620PB	20 Gallon Drum Liners (5pk)	A
N610PB	10 Gallon Drum Liners (5pk)	A
N605PB	5 Gallon Drum Liners (5pk)	A
N650PBA	55 Gallon NED Drum Liners (10pk)	B
N630PBA	20 & 30 Gallon NED Drum Liners (10pk)	B



Drum Dolly

Avoid dragging heavy drums across a floor. Rugged, durable dollies make transportation a cinch, even when the vacuum unit is full. Sturdy steel frame features load-stabilizing lip. Swivel casters allow for easy rolling and wide range of motion. Supports up to 1,000 pound load.

Part No.	Model/Description	Figure
N668	55 Gallon Drum Dolly Assembly	A
N667	30 Gallon Drum Dolly Assembly	A
N204	20 & 30 Gallon Drum Dolly Assembly	B



Grounding Clamp Assembly

Grounding clamp provides electrical grounding for vacuums in applications where static buildup is of concern. Attaches to grounding lug on NED or ATEX vacuums. Clamp can be attached to grounded surface such as iron water pipe or structural steel.

Part No.	Model/Description
14VA120	1/8" x 10' Grounding Clamp Assembly
14VA240	1/8" x 20' Grounding Clamp Assembly



Standard-Duty Vacuum Hose

Flexible and crushproof, an excellent multi-purpose hose for commercial and industrial applications. Performs equally well in wet or dry environments. Features lightweight construction, abrasion-resistant exterior, and smooth interior for maximum airflow.

Part No.	Model/Description
N12510	1.25" ID x 10' Standard-Duty Vinyl Vacuum Hose
N69110	1.5" ID x 10' Standard-Duty Vinyl Vacuum Hose
N69120	1.5" ID x 20' Standard-Duty Vinyl Vacuum Hose
N69130	1.5" ID x 30' Standard-Duty Vinyl Vacuum Hose
N69150	1.5" ID x 50' Standard-Duty Vinyl Vacuum Hose
N67010	2" ID x 10' Standard-Duty Vinyl Vacuum Hose
N67020	2" ID x 20' Standard-Duty Vinyl Vacuum Hose
N67030	2" ID x 30' Standard-Duty Vinyl Vacuum Hose
N67040	2" ID x 40' Standard-Duty Vinyl Vacuum Hose
N67050	2" ID x 50' Standard-Duty Vinyl Vacuum Hose



Heavy-Duty Vacuum Hose

Tackle the toughest industrial and commercial jobs with reinforced Heavy-Duty Vacuum Hose. Made of transparent, durable polyurethane and reinforced with a blue external rigid ABS helix. Repels corrosion from many abrasive products and chemicals. Weather resistant, resists sun damage, mildew, and extreme temperatures. Features excellent flexibility and a smooth interior for uninterrupted flow. Crushproof and kink-resistant.

Part No.	Model/Description
N690	1.5" ID x 20' Heavy-Duty Vacuum Hose
N69050	1.5" ID x 50' Heavy-Duty Vacuum Hose
N669	2" ID x 20' Heavy-Duty Vacuum Hose



Standard-Duty Static Conductive Vacuum Hose

Flexible and crushproof, an excellent multi-purpose hose for commercial and industrial applications. Flexible and easy-to-bend. Performs equally well in wet or dry environments. Features lightweight construction, abrasion-resistant exterior, and static conductive interior to eliminate static electricity at the source. Available as stand-alone item or factory installed option.

Part No.	Description
N86110	1.25" ID x 10' Standard-Duty Static Conductive Vacuum Hose
2100A02NED	1.5" ID x 10' Standard-Duty Static Conductive Vacuum Hose
N653	1.5" ID x 20' Standard-Duty Static Conductive Vacuum Hose
N654	2" ID x 20' Standard-Duty Static Conductive Vacuum Hose



Heavy-Duty Static Conductive Vacuum Hose

Flexible and crushproof, an excellent multi-purpose hose for commercial and industrial applications. Flexible and easy-to-bend. Performs equally well in wet or dry environments. Features lightweight construction, abrasion-resistant exterior, and static conductive rubber interior to eliminate static electricity at the source for safe, effective, and efficient performance. Available as stand-alone item or factory installed option.

Part No.	Description
N661	1.5" ID x 20' Heavy-Duty Static Conductive Vacuum Hose
N662	2" ID x 20' Heavy-Duty Static Conductive Vacuum Hose



Vacuum Attachment Kit

5-piece vacuum attachment kit. Includes the most popular tools and accessories for tackling a range of industrial cleaning jobs. Comes with crevice tool, wet/dry floor tool, wand, and 20' standard-duty vacuum hose. Compatible with 1.5" or 2" vacuum hose accessories.

Part No.	Model/Description
NSVK15	Vacuum Attachment Kit for 1.5" ID Hose
NSVK20	Vacuum Attachment Kit for 2" ID Hose

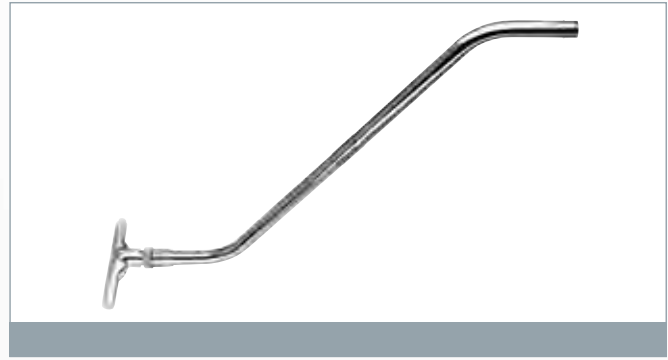

Metal Wet/Dry Floor Tool With Wand

This all-around workhorse, performs on nearly any kind of surface and sucks up a variety of materials, from sand to sawdust to liquid spills. Features an aluminum body with two-piece button locking steel wand. For wet or dry pickup. Compatible with 1.5" or 2" ID vacuum hose accessories.

Part No.	Model/Description
N692	12" Metal Wet/Dry Floor Tool with Wand for 1.5" ID Hose
N639	12" Metal Wet/Dry Floor Tool with Wand 2" ID Hose



Metal Squeegee Tool

Quickly dry wet floors and suck up excess water. Replaceable neoprene blades won't mark up or damage surfaces, while a lightweight aluminum body provides ease of use and lasting durability. Compatible with 1.5" ID vacuum hose accessories.

Part No.	Model/Description
N692S	14" Metal Squeegee Tool for 1.5" ID Hose



Metal Floor Tool with Bristles

Designed to clean dry materials from floors and other surfaces. Ideal for sucking up dirt, powder, or other construction materials. Nylon bristles with lightweight, aluminum body offers ease of use and durability. Compatible with 1.5" ID vacuum hose accessories.

Part No.	Model/Description
N692B	14" Metal Floor Tool with Bristles for 1.5" ID Hose



Metal Bulk Sand Pick-Up Tool

Quickly and efficiently extracts large volumes of sand or plastic pellets without clogging or losing suction. Secondary draft tube allows for continuous vacuum flow even when tool is dead-ended. Lightweight steel construction. Durable nickel chrome finish resists rust and abrasion. For wet or dry pick up. Compatible with 1.5" or 2" ID vacuum hose accessories.

Part No.	Model/Description
N665	22" Metal Bulk Sand Pick-Up Tool for 1.5" ID Hose
N666	22" Metal Bulk Sand Pick-Up Tool for 2" ID Hose



Metal Crevice Tool

Ideal for vacuuming hard-to-reach places, and excels in bulk pickup. Narrow, angled working end increases vacuum efficiency. For wet or dry pickup. Compatible with 1.5" or 2" ID vacuum hose accessories.

Part No.	Model/Description
N6931	11" Metal Crevice Tool for 1.5" ID Hose
N693	24" Metal Crevice Tool for 1.5" ID Hose
N674	24" Metal Crevice Tool for 2" ID Hose



Plastic Crevice Tool

Ideal for vacuuming hard-to-reach places, and excels in bulk pickup. Narrow, angled working end increases vacuum efficiency. For wet or dry pickup. Compatible with 1.25" or 1.5" ID vacuum hose accessories.

Part No.	Model/Description
N849	9" Plastic Crevice Tool for 1.25" ID Hose
N693P	11" Plastic Crevice Tool for 1.5" ID Hose



Plastic Extension Wand

Provides 20 inches of additional reach for vacuum accessories and tools. Ideal for reaching out-of-the-way spots or preventing back strain. Compatible with 1.25" ID vacuum hose accessories.

Part No.	Model/Description
N842	20" Plastic Extension Wand for 1.25" ID Hose



Metal Utility Tool with Brush

Built to last, and ideal for vacuuming floors or other flat surfaces. Heavy-duty aluminum base with natural horsehair brush prevents damage while delivering superior vacuum power. Brush insert slides off for easy cleaning. 2" model includes 14.5" steel extension.

Part No.	Description
N659	6" Wide Metal Utility Tool for 1.5" ID Hose
N6592	6" Wide Metal Utility Tool for 2" ID Hose



Plastic Utility Tool with Brush

Lightweight, economical tool for cleaning floors or other flat surfaces. Polypropylene bristles prevent damage while delivering superior vacuum power. Brush slides on and off for easy cleaning.

Part No.	Description
N845	6" Wide Plastic Utility Tool for 1.5" ID Hose



Metal Round Brush Tool

The ideal accessory for vacuuming in a wide variety of locations. Heavy-duty aluminum base with round, horsehair brush prevents scratching of delicate surfaces while still delivering superior vacuum power. 2" model includes 14.5" steel extension.

Part No.	Description
N636	5" Round Brush Tool for 1.5" ID Hose
N6362	5" Round Brush Tool for 2" ID Hose



Plastic Round Brush Tool

Lightweight, economical and ideal for vacuuming a wide variety of locations. Tough high-grade plastic base with polypropylene bristles prevent scratching of delicate surfaces while still delivering superior vacuum power.

Part No.	Description
N843	3" Round Brush Tool for 1.25" ID Hose
MV2000BR	3" Round Brush Tool for 1.5" ID Hose

Can't find the replacement part you're looking for?

**Visit www.guardair.com
or call 800-482-7324**

and speak with our product support team.

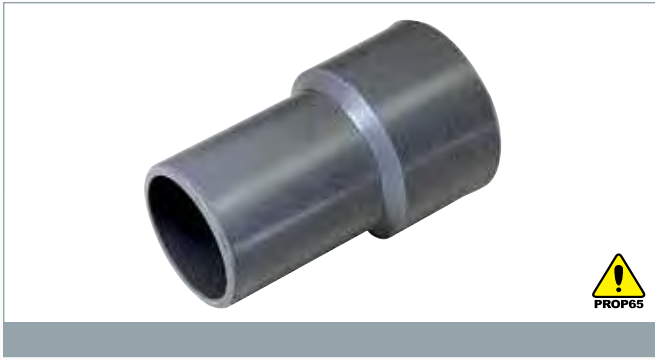

Standard-Duty Vacuum Hose Cuff

Threads over vacuum hose providing a secure and positive connection to vacuum unit, tools, and accessories.

Part No.	Description	Outlet
N824	For 1.25" ID Vac Hose	1.25" ID
N621	For 1.5" ID Vac Hose	1.5" ID
N622	For 2" ID Vac Hose	2" ID



Steel Vacuum Hose Adapter

Connect vacuum hose to vacuum inlet on drum head. Nickel chrome-plated 18-gauge steel construction. For 55/30/20 gallon vacuums.

Part No.	Description
N715	1.5" OD Steel Vacuum Hose Adapter.
N720	2" OD Steel Vacuum Hose Adapter



Standard-Duty Vacuum Hose Cuff Adapter

Vinyl hose cuff threads over 1.25" ID vacuum hose providing a secure and positive connection to 1.5" vacuum tools.

Part No.	Description	Outlet
N825	For 1.25" ID Vac Hose	1.5" ID



Plastic Angled Tool Coupler

Angled tool coupler provides ergonomic advantage as well as 9.5" of extra reach. Attaches to 1.5" hose cuff and is compatible with 1.25" vacuum hose tools.

Part No.	Description	Outlet
N8412	For 1.5" ID Vac Hose	1.25" OD



Steel Vacuum Hose Coupler

Heavy-duty Steel Vacuum Hose Coupler provides secure connection and prevents loss of suction when attaching two, same-size diameter vacuum hoses. Use of hose clamps (not included) optional.

Part No.	Inlet	Outlet
N672	1.5" OD	1.5" OD
N671	2" OD	2" OD

Hose & Fittings

Wide variety of hose and quick disconnect fittings to power your air tools.



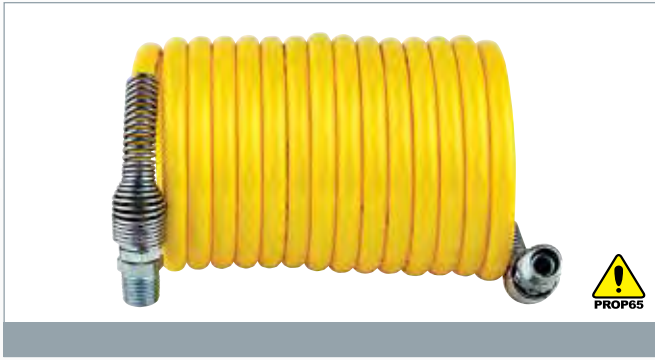

Nylon Coilguard® Air Hose

Compact storage profile minimizes clutter and hose dragging. Ideal for overhead applications. Eliminates the need for bulky hose reels.

Features

- Lightweight nylon air hose
- Excellent dimensional stability
- Resists most chemicals
- Equipped with zinc-plated brass swivel fittings

Part No.	ID	Length	Max Pressure	Hose Ends
14X12B03	1/4"	12'	250 psi	1/4" NPT
14X25B03	1/4"	25'	250 psi	1/4" NPT
14X50B03	1/4"	50'	250 psi	1/4" NPT
38X12B03	3/8"	12'	200 psi	3/8" NPT
38X25B03	3/8"	25'	200 psi	3/8" NPT
38X50B03	3/8"	50'	200 psi	3/8" NPT
12X25B03	1/2"	25'	150 psi	1/2" NPT



Polyurethane Air Hose

Finest polyurethane air hose available on the market. Super flexible, 100% kink proof, with low tension retractability. Withstands tough industrial environments while maintaining resiliency. Soft polyurethane will not scratch or mar work surfaces.

Features

- 18" pigtail on tool end
- 4" pigtail on supply end
- Pre-installed brass swivel fittings

Part No.	ID	Length	Max Pressure	Hose Ends
14X12B04	1/4"	12'	125 psi	1/4" NPT
14X25B04	1/4"	25'	125 psi	1/4" NPT
38X12B04	3/8"	12'	125 psi	3/8" NPT
38X25B04	3/8"	25'	125 psi	3/8" NPT



General Purpose Hose

Industrial grade general purpose air hose. Large inner diameter allows unrestricted air flow to meet demands of high-power tools such as pneumatic vacuums and big air guns.

Features

- Heavy-duty EPDM rubber
- Pre-installed fittings
- Temperature range: -20° F - 180° F

Part No.	ID	Length	Max Pressure	Hose Ends
N607	1/2"	20'	250 psi	1/2" Industrial Interchange Plug and Coupler
N606	3/4"	20'	250 psi	Universal Coupling
HT113	1"	50'	150 psi	Universal Coupling



Static Conductive Air Hose

Static Conductive Air Hose is ideal for supplying compressed air to Guardair vacuums in applications where static electricity is of concern. Reinforced rubber provides excellent ozone resistance and long-term durability. Air fittings tested to industry standards. Includes factory installed connectors.

Part No.	ID	Length	Max Pressure	Hose Ends
2100A01NED	3/8"	20'	300 psi	3/8" Industrial Interchange Plug and Coupler
N607NED	1/2"	20'	300 psi	Universal Coupling
N606NED	3/4"	20'	290 psi	Universal Coupling

Quick Disconnect Plugs

Quickly and safely swap out air tools with Quick Disconnect Plugs and Couplers. Provides for quick tool change without need to shut off air supply.

Choose from Industrial Interchange (M-Style) or High-Flow (V-Style) for twice the amount of air flow to deliver maximum power. Body size must match between plug and coupler.



Male Threaded Plugs

Body Size	Threads	Material	Industrial (M-Style) Part No.	High-Flow (V-Style) Part No.
1/4"	1/4" NPT	Steel	P14D14M	P14H14M
	3/8" NPT	Steel	P14D38M	P14H38M
3/8"	3/8" NPT	Steel	P38D38M	-



Female Threaded Plugs

Body Size	Threads	Material	Industrial (M-Style) Part No.	High-Flow (V-Style) Part No.
1/4"	1/4" NPT	Steel	P14D14F	P14H14F
	3/8" NPT	Steel	P14D38F	P14H38F
3/8"	3/8" NPT	Steel	P38D38F	-



Hose Barbed Plugs

Body Size	Hose Barb	Material	Industrial (M-Style) Part No.	High-Flow (V-Style) Part No.
1/4"	1/4"	Steel	P14D14B	P14H14B
3/8"	3/8"	Steel	P38D38B	P38H38B



Quick Disconnect Couplers



Quickly and safely swap out air tools with Quick Disconnect Plugs and Couplers. Provides for quick tool change without need to shut off air supply.

Couplers have internal valve spring that safely shuts off air flow when disconnected from plug, preventing air leaks. Universal coupler features automatic push-to-connect compatibility with both Industrial Interchange (M-Style) and High-Flow (V-Style) plugs. Body size must match between plug and coupler.

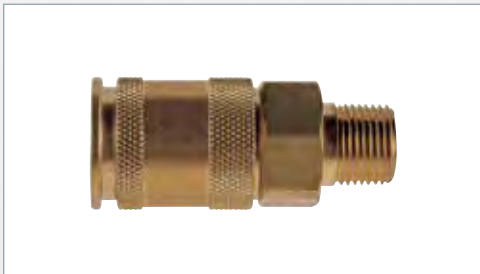

Male Threaded Couplers

Body Size	Threads	Material	Universal* Part No.
1/4"	1/4" NPT	Brass	C14U14M
	3/8" NPT	Brass	C14U38M
3/8"	3/8" NPT	Brass	C38U38M

*Accepts both M and V-Style plugs.



Female Threaded Couplers

Body Size	Threads	Material	Universal* Part No.
1/4"	1/4" NPT	Brass	C14U14F
	3/8" NPT	Brass	C14U38F
3/8"	3/8" NPT	Brass	C38U38F

*Accepts both M and V-Style plugs.



Hose Barbed Couplers

Body Size	Threads	Material	Universal* Part No.
1/4"	1/4" NPT	Brass	C14U14B
	3/8" NPT	Brass	C14U38B

*Accepts both M and V-Style plugs.



Flex-Angle Swivel Fittings

Unique, patented swivel fitting provides 360° of rotation and up to 45° of angle. Eliminates hose kinking and reduces user stress from heavy or non-flexible air hose.

Features

- Rugged, nickel-plated steel construction
- 360° circular rotation and 45° angled rotation
- Dual rotation points prevents kinking of supply line
- Steel dust cover protects rotating joint

Part No.	Inlet	Outlet	Figure
14NFMH05	1/4" NPT	1/4" FNPT	A
38NFMH05	3/8" NPT	3/8" FNPT	B
14UMNMH05	1/4" NPT	1/4" Plug*	C

* Industrial Interchange

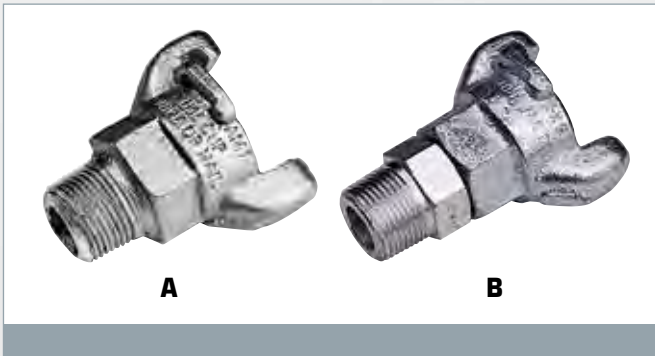

Universal Coupling

Universal "Chicago Style" Coupling provides a quick and safe method to connect air hose to air tools. Compatible with all 2-claw universal couplings. Unobstructed inner diameter ensures high flow. Available with 360° swivel joint to prevent hose kinking.

Features

- Max pressure: 150 psi @ 70° F
- Safety clip included

Part No.	Inlet	Material	Figure
N610	1/2" NPT	Steel	A
34AKM05	3/4" NPT	Iron	A
34SAKM05*	3/4" NPT	Iron/Steel	B

*360° Swivel Fitting



Safety Excess Flow Check Valve

Automatically shuts off air flow upon a sudden air line break. Protects plant personnel and property from injury by "whipping" air hoses. Resets when repair is made. Allows full, unrestricted flow of air in normal open position.

Part No.	Model/Description	Max Recommended Hose Length*	Trip Level* (cfm)
14H18	1/4" FNPT - For 1/4" ID Hose	30'	90
38H18	3/8" FNPT - For 3/8" ID Hose	75'	50
12H18	1/2" FNPT - For 1/2" ID Hose	75'	25

*At 100 psi



500A04

Safety Cable

Provides positive attachment of air hose to air tools in case of inadvertent disconnect. Spring loaded loop makes for easy installation. Ideal for Force 5 and Inforcer Series safety air guns.

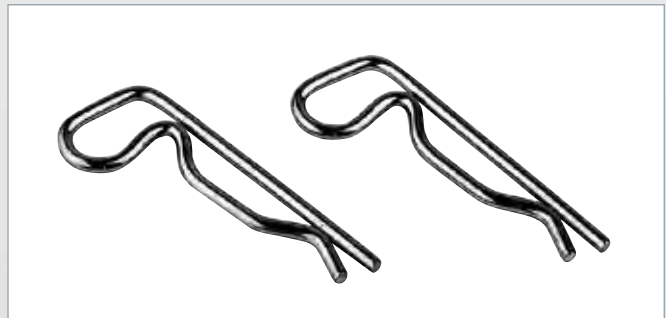

500A02

Safety Clips

Carbon steel safety clips provide added measure of safety when used with Universal "Chicago Style" Couplings.

GUARDAIR WARRANTIES

Air Gun Warranty

GUARDAIR LIMITED WARRANTY:

Guardair Corporation warrants that, under normal use, our products are free from defects in materials or workmanship for a period of one year from date of shipment. During the warranty period, Guardair Corporation will, at our discretion and at no extra cost, repair or replace defective products or parts, or refund the purchase price. This Limited Warranty extends only to products that are purchased either directly from Guardair Corporation or from an authorized Guardair Corporation Customer. Furthermore, the Limited Warranty extends only to products which are used for their intended purpose. This Limited Warranty does not extend to any product which has been misused, or that has been damaged from accident or mistreatment, from the use of parts not supplied by Guardair Corporation, or from modification or servicing of the product by anyone other than Guardair Corporation or its authorized Customer.

THE FOREGOING LIMITED WARRANTY OF GUARDAIR CORPORATION IS IN LIEU OF ALL OTHER WARRANTIES OF GUARDAIR CORPORATION, EXPRESSED OR IMPLIED, WITH RESPECT TO THE PRODUCT, INCLUDING WITHOUT LIMITATION WARRANTIES OF MERCHANT ABILITY OR FITNESS FOR A PARTICULAR PURPOSE. GUARDAIR CORPORATION EXPRESSLY DISCLAIMS ALL WARRANTIES NOT STATED IN THIS LIMITED WARRANTY. IN NO EVENT SHALL GUARDAIR CORPORATION BE LIABLE FOR ANY INDIRECT, SPECIAL OR CONSEQUENTIAL DAMAGES IN CONNECTION WITH THIS PRODUCT.

Vacuum Warranty

GUARDAIR STANDARD AND NED VACUUMS OFFER A FOREVER WARRANTY.

GUARDAIR ATEX CERTIFIED VACUUMS OFFER A TWO YEAR LIMITED WARRANTY.

GUARDAIR FOREVER WARRANTY:

Guardair Vacuum Products Division of Guardair Corporation ("Guardair") warrants its Guardair Compressed Air Powered Industrial Vacuums to be free from defects in materials and workmanship for as long as the original end-user purchaser owns the product, except as provided below. Guardair will, at its option, repair or replace with comparable product, any product, part, or component which fails under normal use as a result of such defect. This warranty does not apply to damage caused by the carrier; normal wear and tear; deterioration due to solvents, corrosives, environmental conditions or harsh vacuumed material; soiling, saturation, or perforation of filters or exhaust silencers; consumable components; modifications to the product; attachments to the product not sold by Guardair; or any product not installed, used, or maintained in accordance with the foregoing and other published Guardair instructions and warnings.

Consumables purchased from Guardair, including attachments, vacuum hose, filters, exhaust silencers, and cover gaskets are warranted for a period of 90 days against defects in materials and workmanship, subject to the same exclusions already noted. This warranty covers the original purchase of new product by an end-user for normal industrial or commercial use only when installed and used as specified and in accordance with published operating instructions and within all applicable regulatory rules, limits, and guidelines.

Distributed By:



visit our website at
guardair.com



GUARDAIR®

47 Veterans Drive • Chicopee, MA 01022-1062

Toll-Free: 800-482-7324 | Local: 413-594-4400 | Fax: 413-594-4884

Email: info@guardair.com • guardair.com

