

Fibreglass Cages

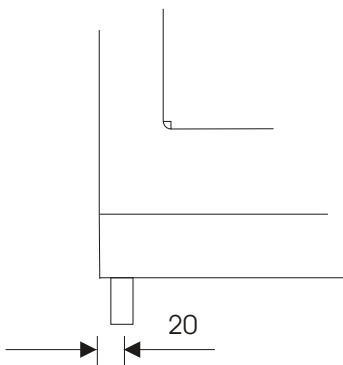

Fibreglass Cages

Side profile

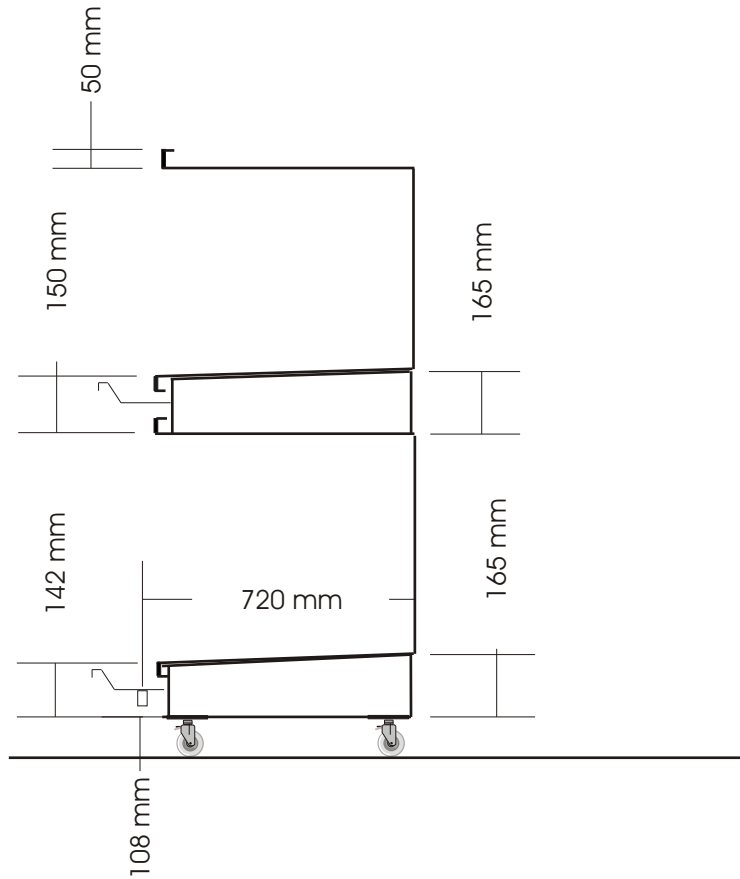

Gutter outlet detail

To Calculate Module Height

- add internal dimensions of cages
- Add 108 for the castors
- add 145 for the base platform
- add 150 for the between platform
- add 50 for the top flange

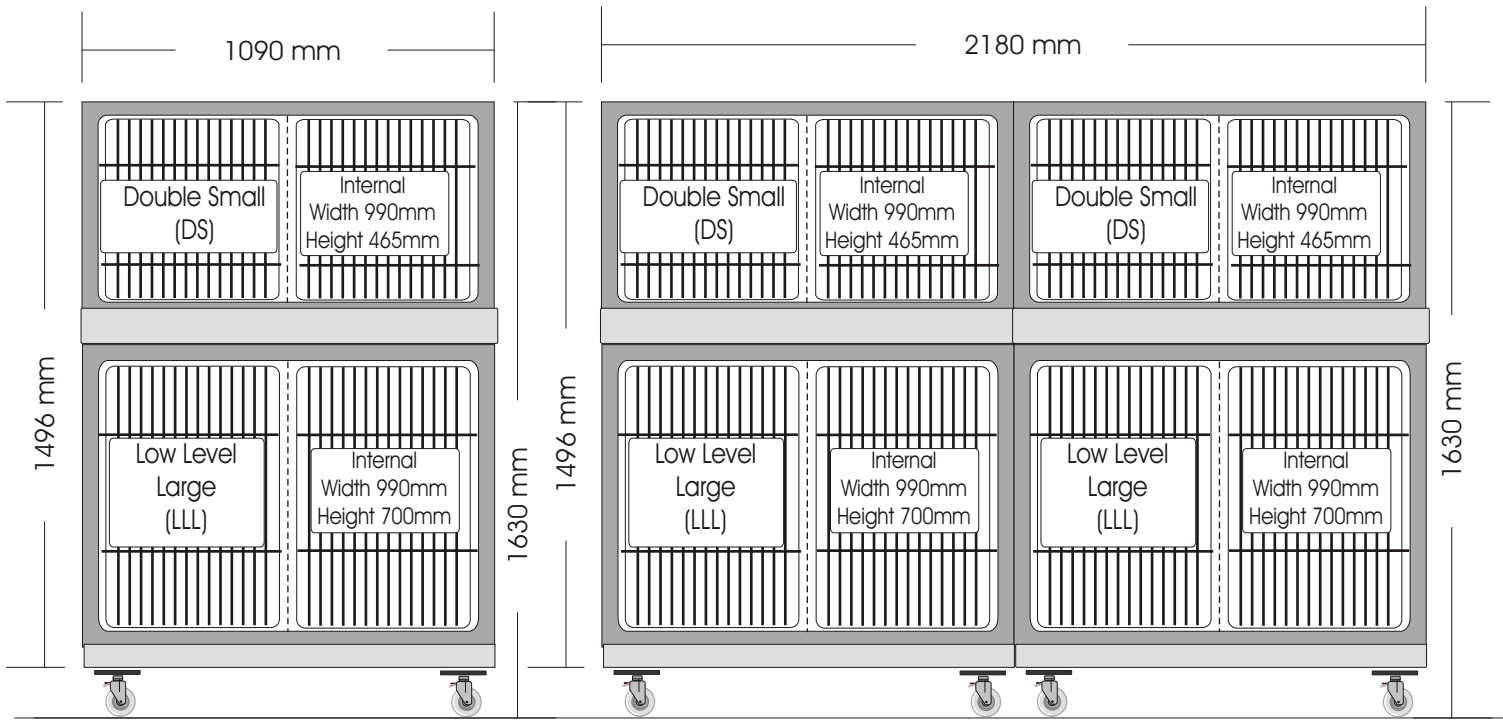

FG 1

FG 2

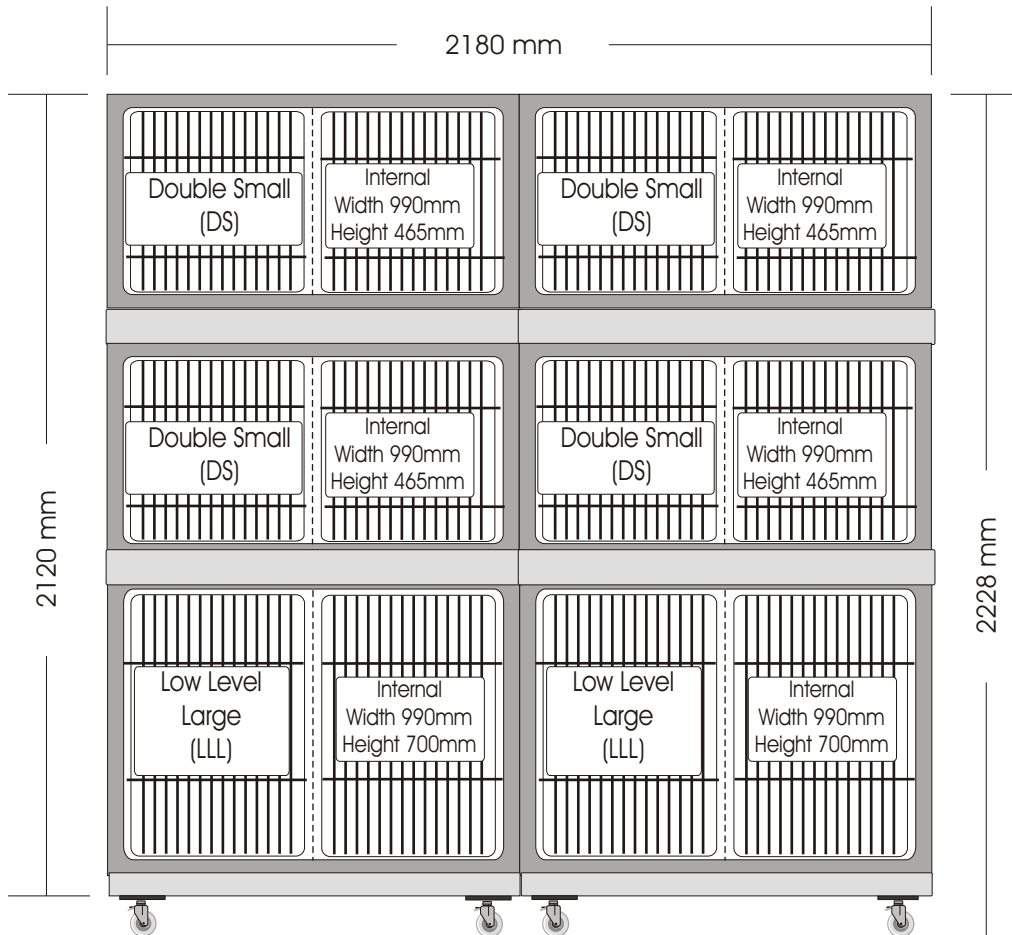

FG 3

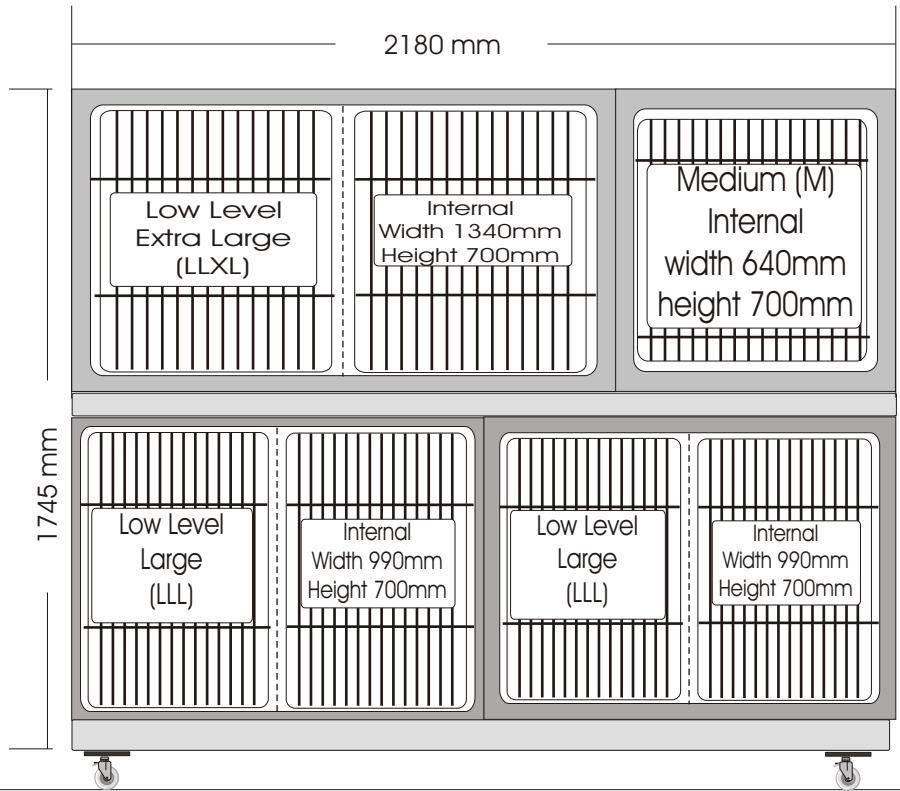

FG 4

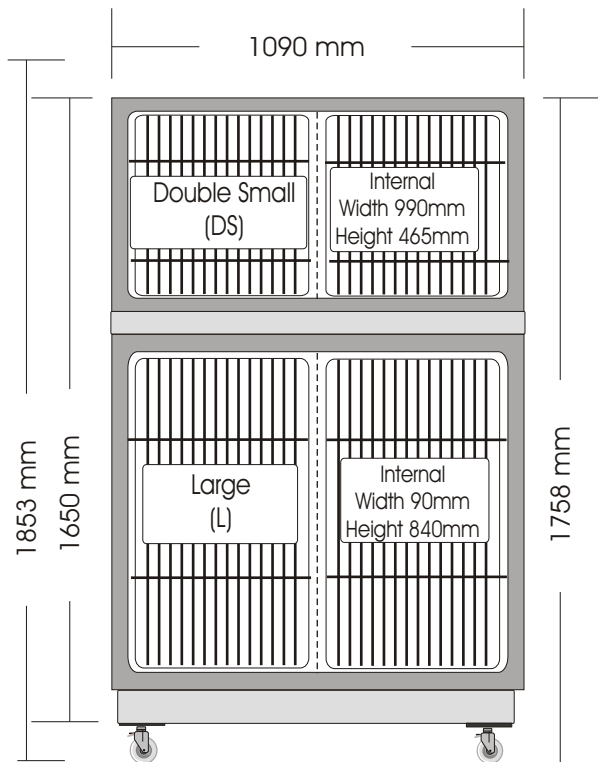

FG 6

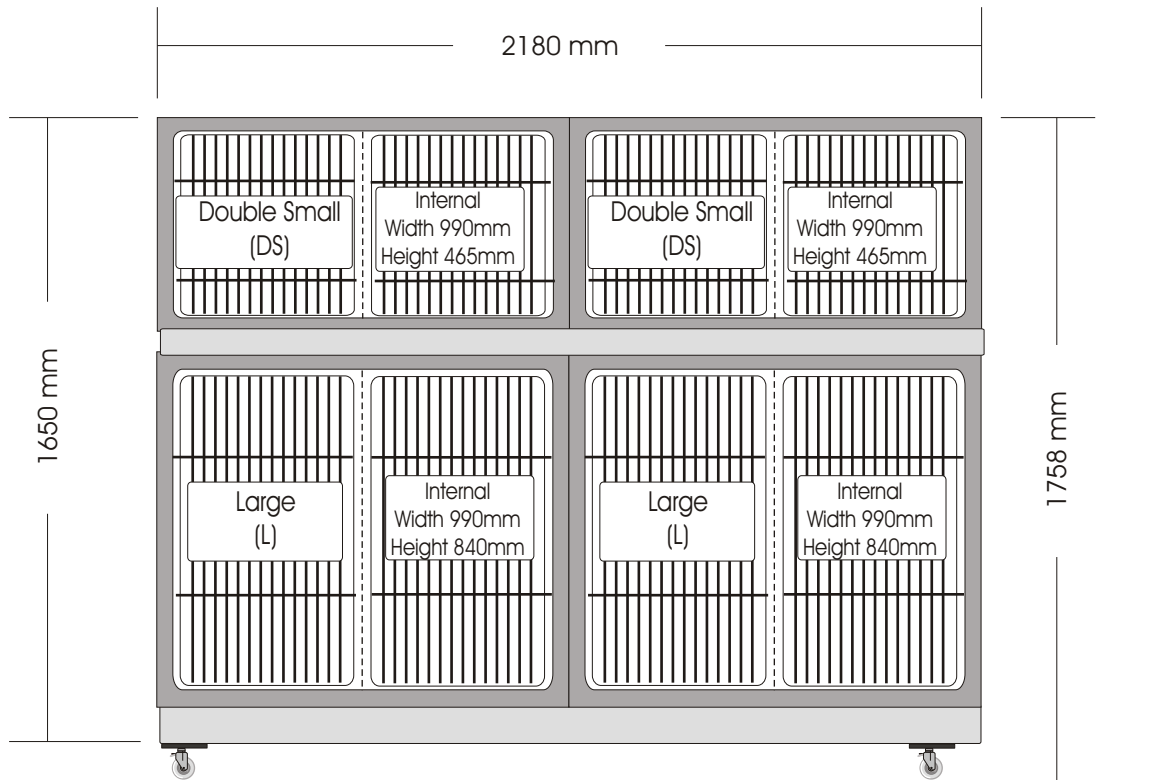

FG 7

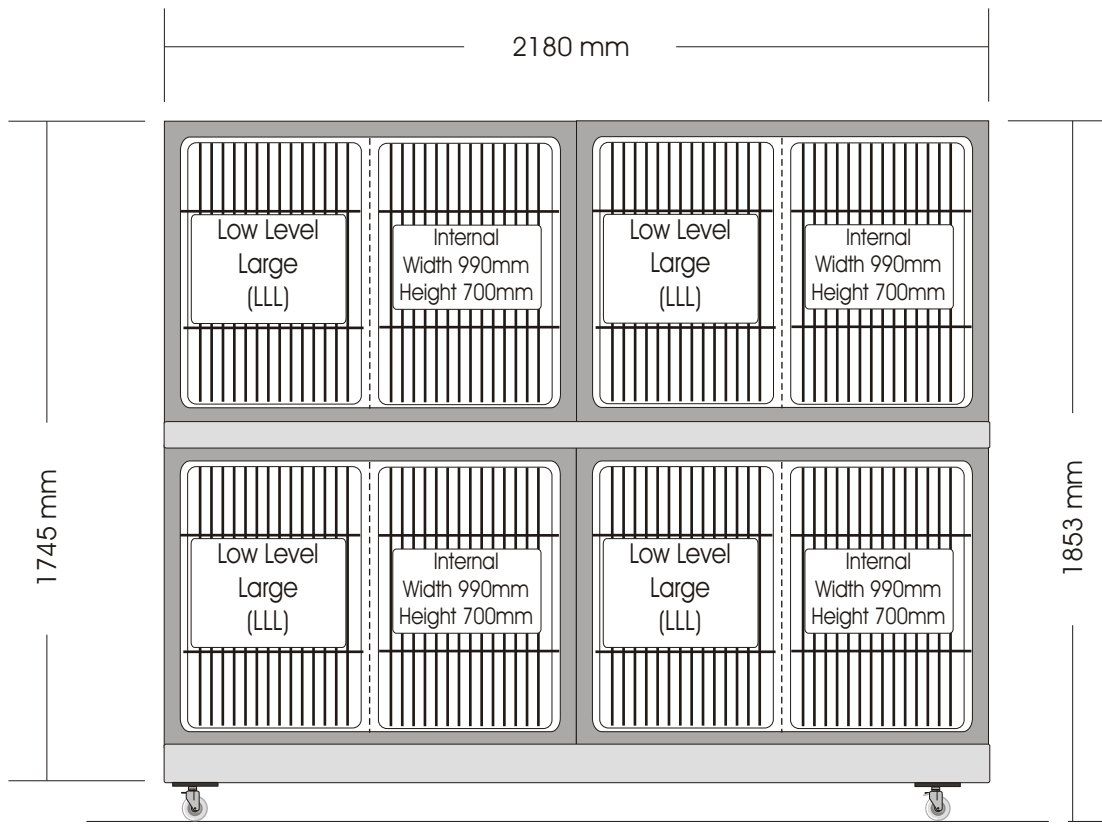

FG 8

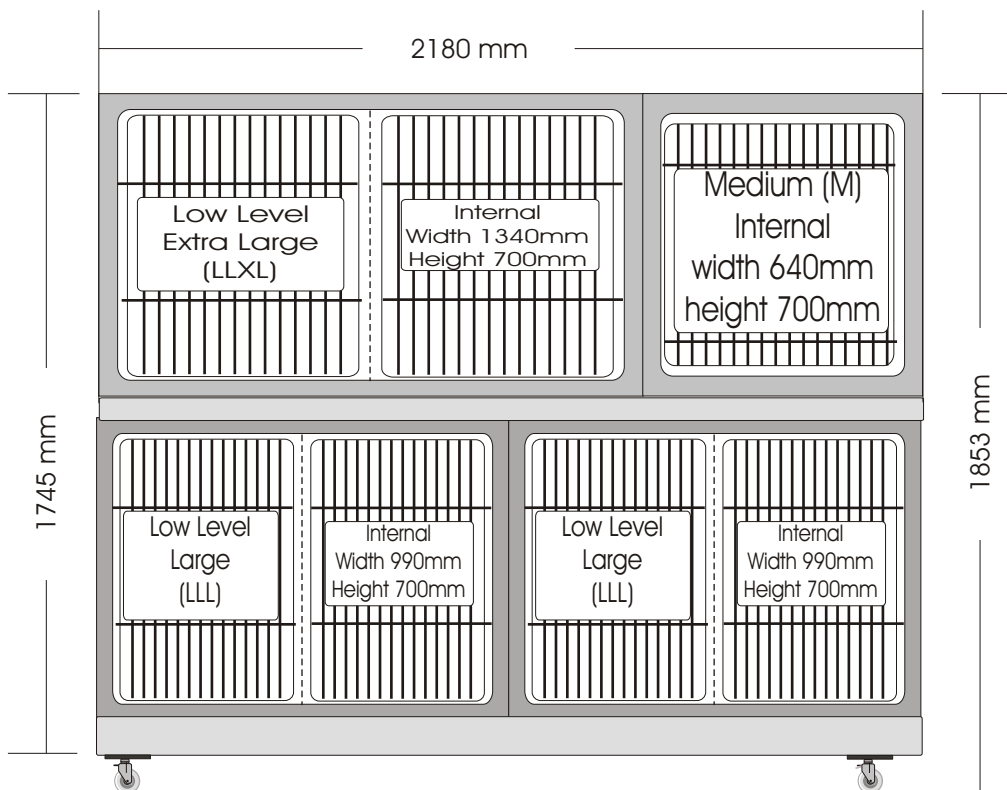

FG 9

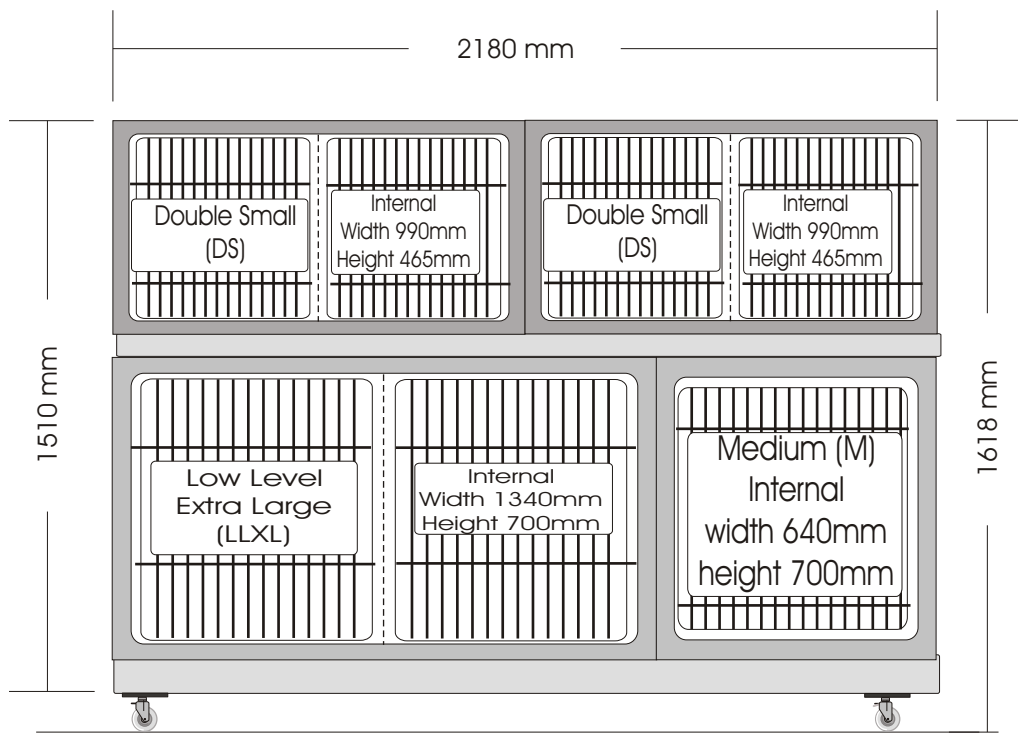

FG 10

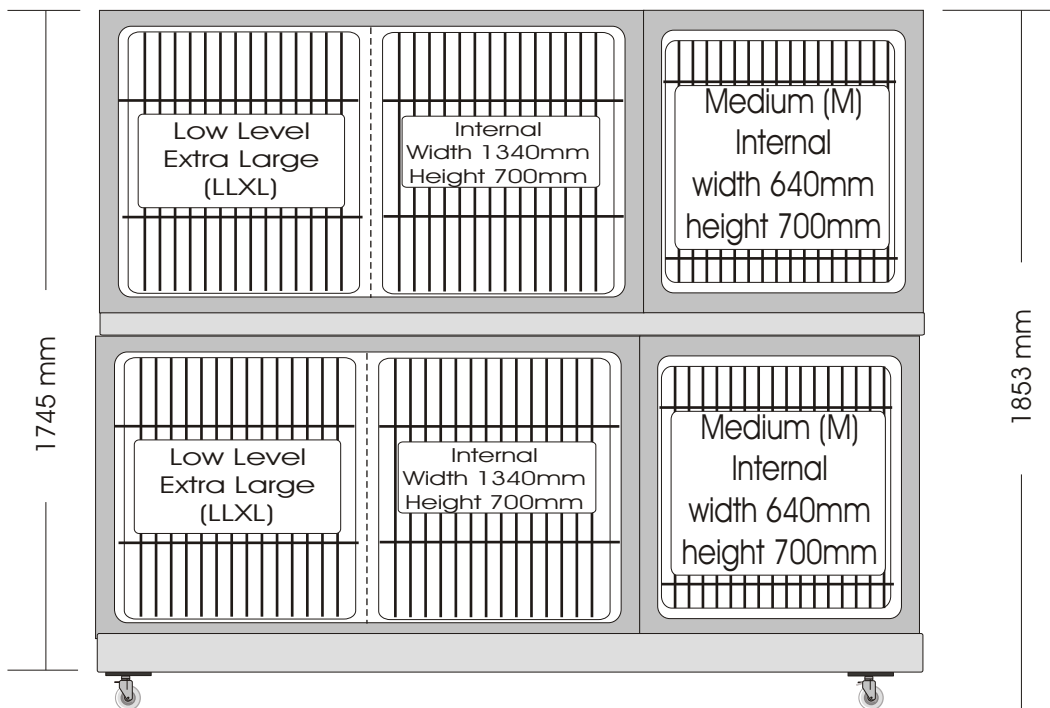

FG 11

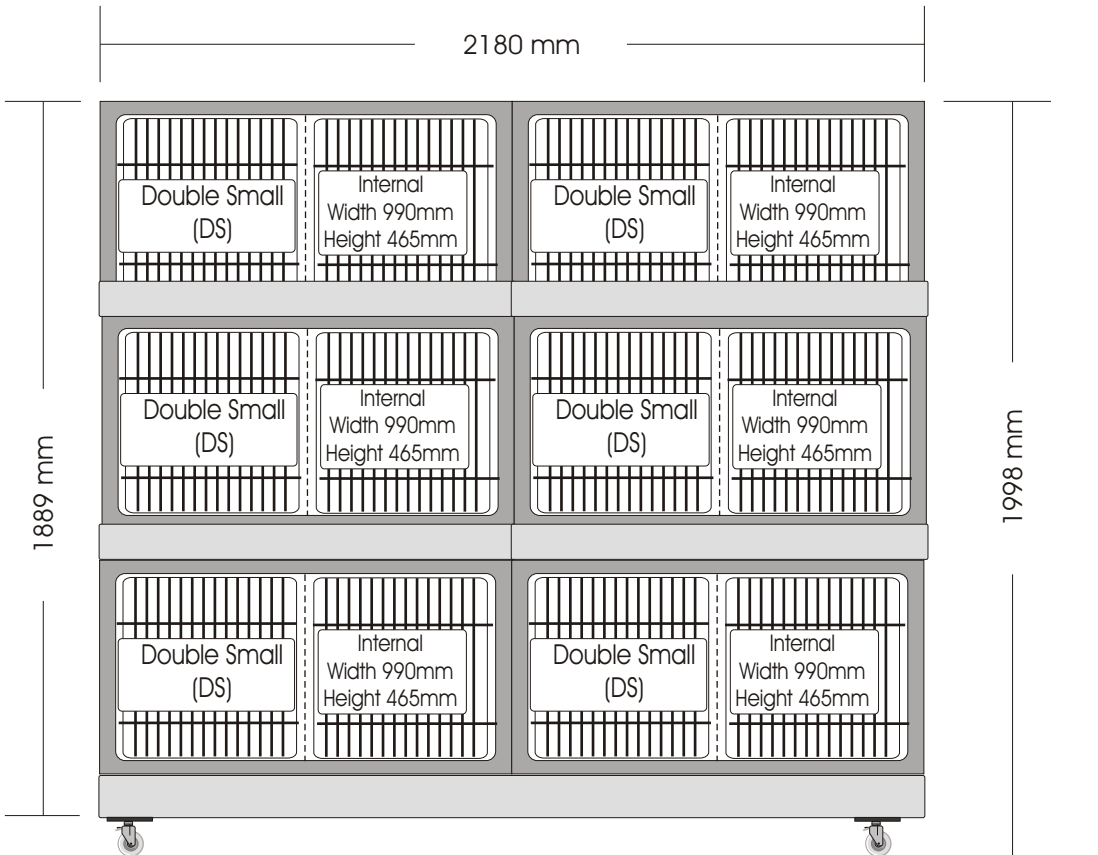

FG 16

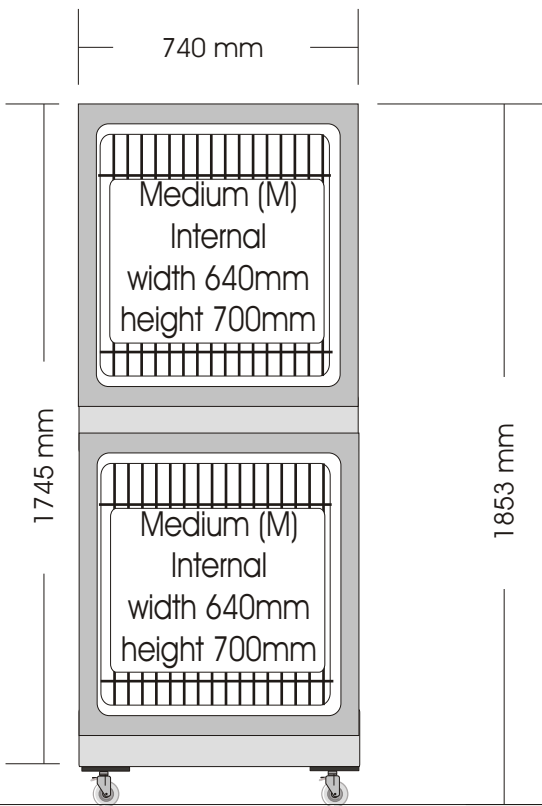

FG 17

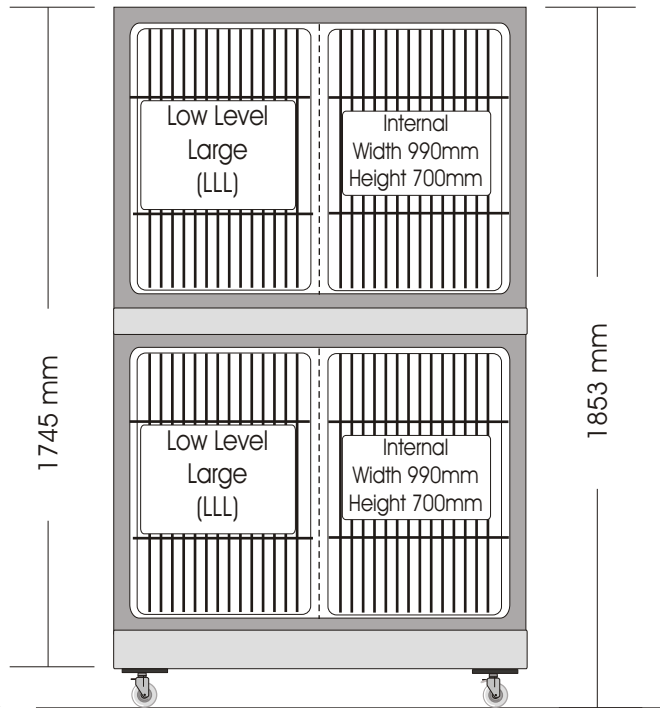

FG 18

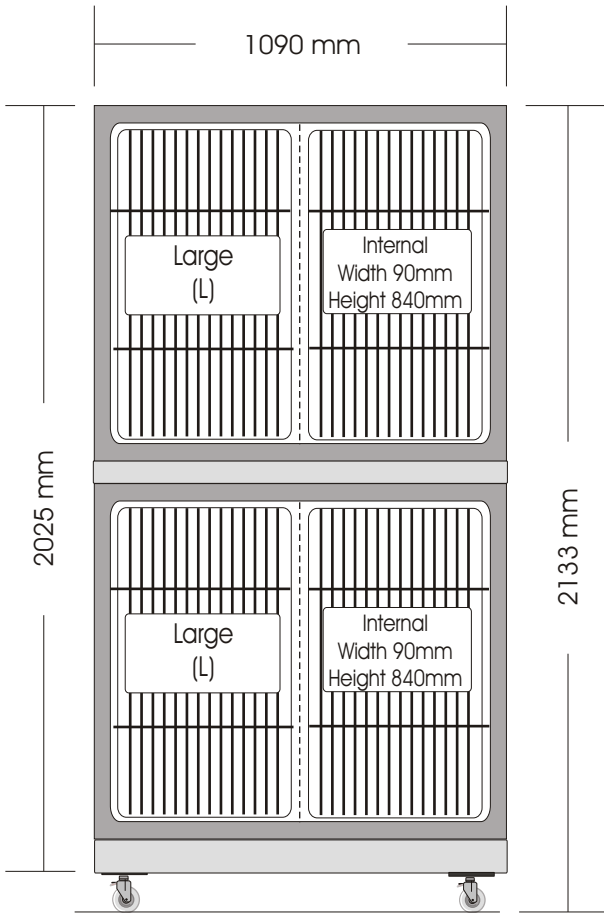

FG 19

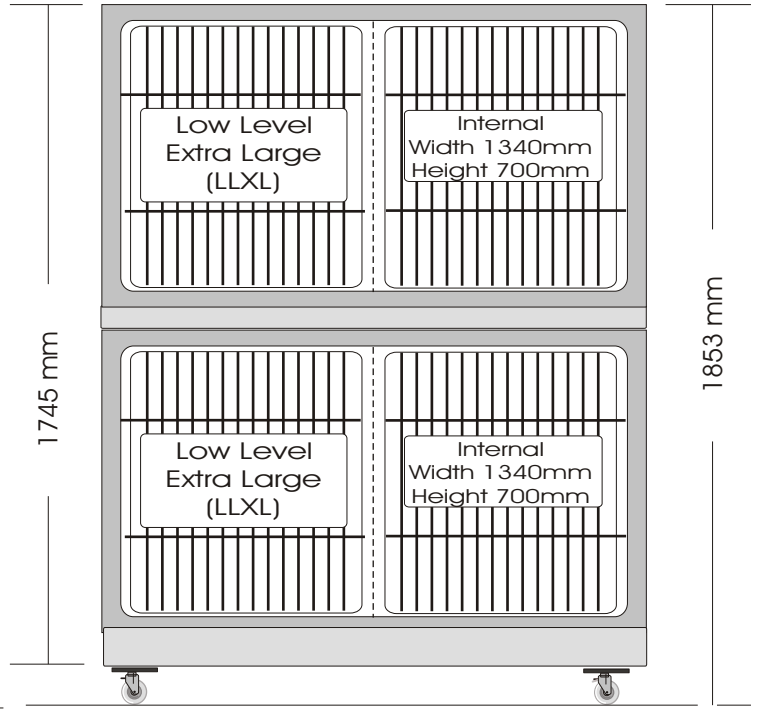

FG 20

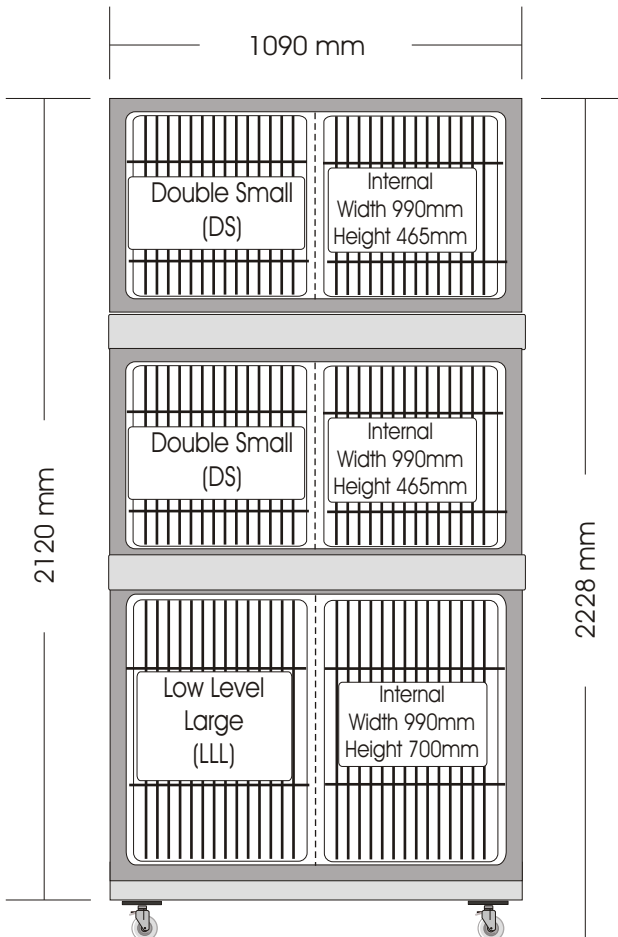

FG 22

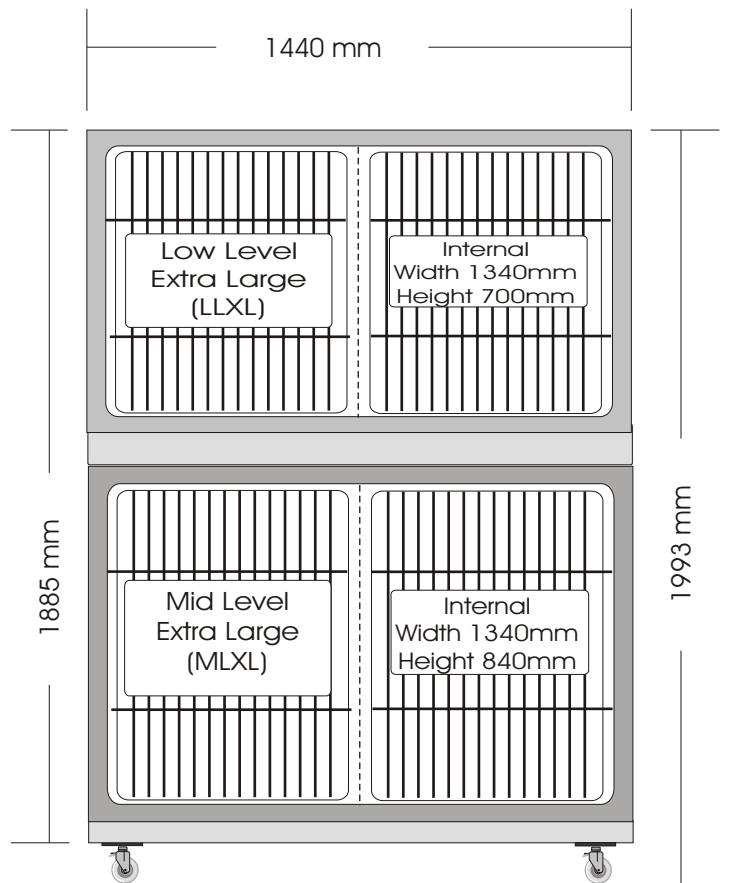

FG 24

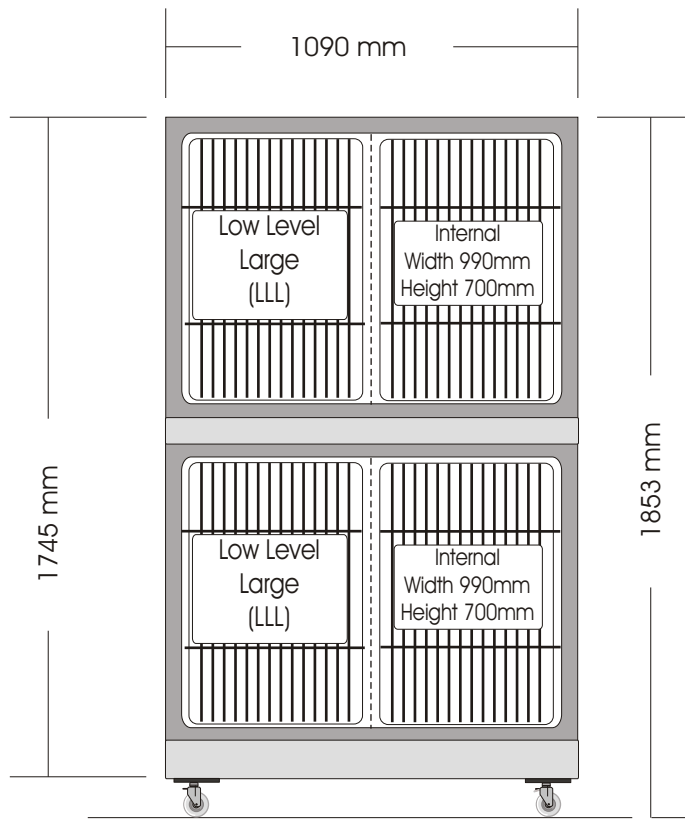

FG 25

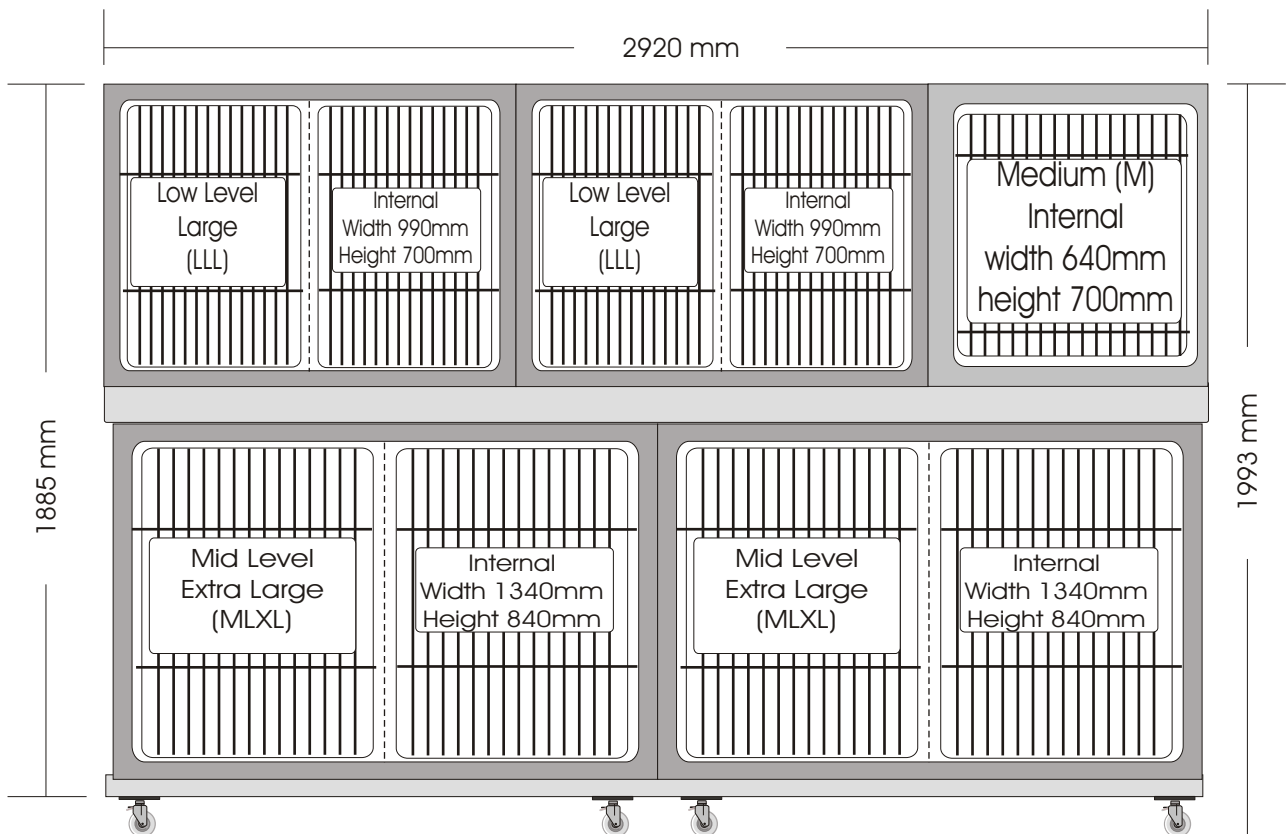

FG 26

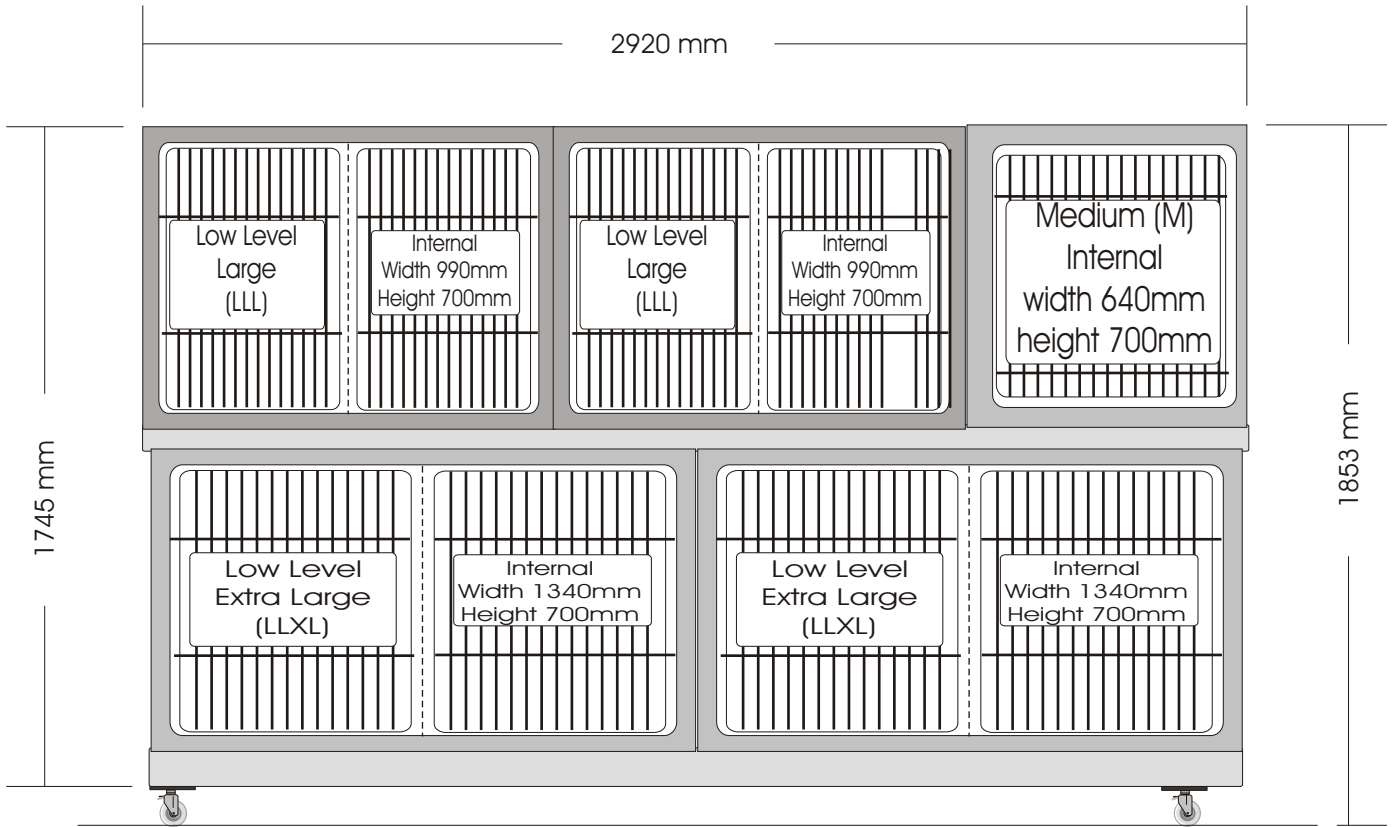

FG 28

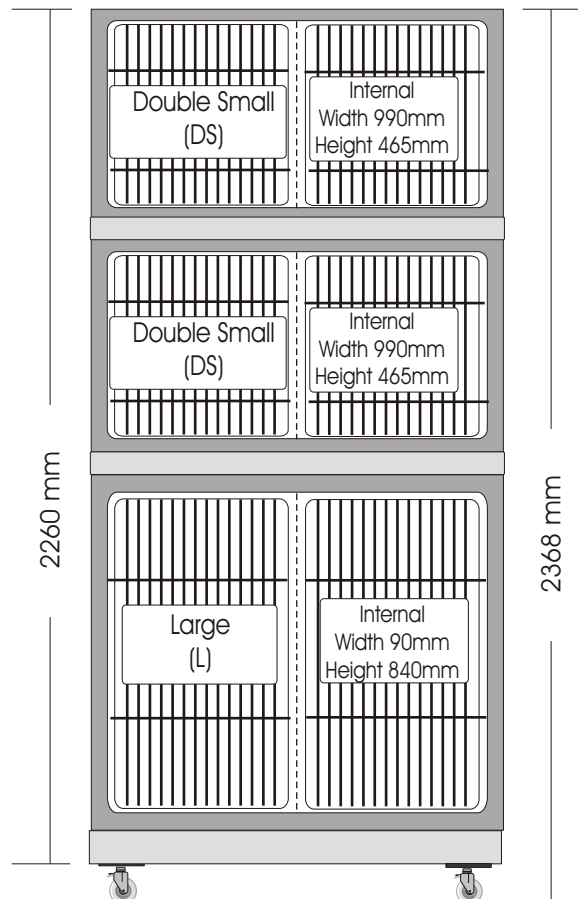

FG 29