



Thanks to a continuous and regular flow, the water is distributed on a refrigerated surface designed to increase ice production. Three different sizes are available **FULL DICE, HALF DICE** and **LARGE DICE**

High production modular ice maker.
Up to 130kg production per 24/hr of dice cube.
Head only, stainless steel cabinet.
Complete with water & drain hoses.
10 AMP power supply.



ICE PRODUCTION

Air Cooled Unit

Air Temp.		Water Temperature			
		32°	21°	15°	10°
°C		32°	21°	15°	10°
°F		90°	70°	60°	50°
10°		129	147	150	154
50°		284	323	330	340
21°		112	127	133	138
70°		247	281	239	305
32°		96	107	110	113
90°		212	236	242	249
38°		79	87	95	98
100°		173	193	209	215

Water Cooled Unit

Air Temp.		Water Temperature			
		32°	21°	15°	10°
°C		32°	21°	15°	10°
°F		90°	70°	60°	50°
10°		123	131	134	136
50°		271	289	295	300
21°		111	121	126	128
70°		245	267	278	282
32°		102	110	117	119
90°		225	243	258	262
38°		100	108	115	116
100°		221	238	254	256

CUBE TYPE

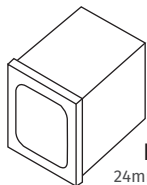

10g
FULL CUBE
24mm x 22mm x 22mm

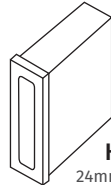

6g
HALF CUBE
24mm x 10mm x 29mm

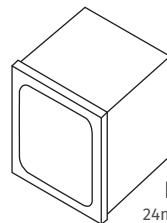

17g
LARGE CUBE
24mm x 29mm x 29mm

Solid ice cube, suitable for quick drink cooling, available in three different sizes, **FULL DICE (M models)**, **HALF DICE (MH models)** and **LARGE DICE (ML models)**, can be used in various applications: ice buckets, whisky on the rocks and cocktails.

CONTROL PANEL

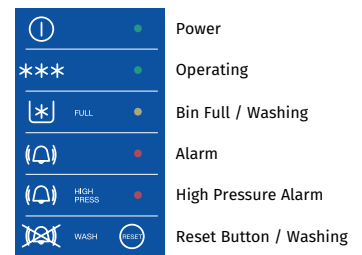

SUGGESTED STORAGE BIN



BH56
Stainless steel storage bin.
120kg capacity.













DIMENSIONS

W x D x H (mm)
560 x 620 x 575

OPERATING REQUIREMENTS

Rejected Heat	1731 W
Air Volume	590 m ³ /h
220-240/50/1	R404a GWP=3922
MIN	MAX
10°C (50°F)	40°C (104°F)
5°C (41°F)	35°C (95°F)
- 10 %	+ 10 %
1 Bar (14 psi)	5 Bar (70 psi)

SPECIFICATIONS

	 cond	 comp. W	 ABS. W	 Fuse	 kWh/100kg	 L / hr	 kg	 lbs	 kg	 lbs	 Ton CO2 equiv.
M132 A		1637	850	10	15.9	7.0	53	117	65	143	1.96
M132 W		1637	750	10	12.1	107.0	53	117	65	143	1.76

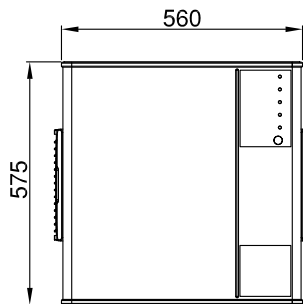

AIR COOLED

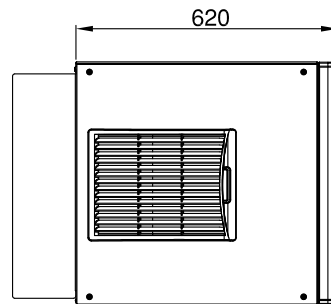

WATER COOLED

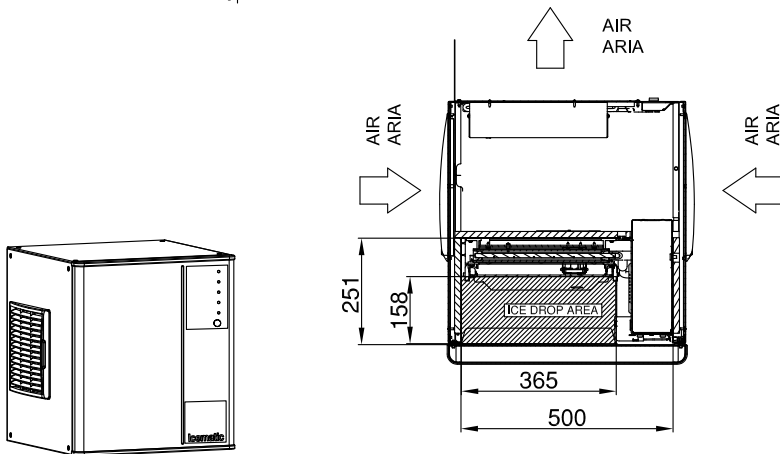
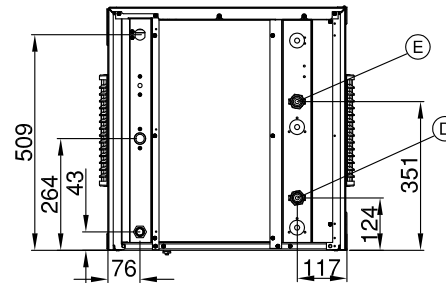
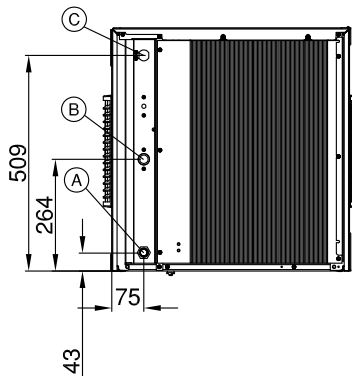

- (A) Water drain 20mm diam.
- (B) Potable water inlet 3/4" gas
- (C) Electrical cable supply
- (D) Water cooled inlet 3/4" gas
- (E) Water cooled outlet 3/4" gas