

SONOREX TECHNIK

Ultrasonic and rinsing baths for aqueous fluids



Valid for:

RM 16 UH, RM 16 U, RM 16 H, RM 16

RM 40 UH, RM 40 U, RM 40 H, RM 40

RM 75 UH, RM 75 U, RM 75 H, RM 75

Copyright & limit of liability

This document may not be reproduced, either in full or in extracts, without prior approval of BANDELIN electronic GmbH & Co. KG, hereinafter referred to as BANDELIN.

The German original is the binding version of this document. Any differences in the translation are not binding and have no legal effect. In case of any discrepancies between the translation and the original of this document, the original version will take precedence.

BANDELIN accepts no responsibility or liability for damages caused by improper handling or usage contrary to the intended purpose.

The documentation was prepared with great care. Liability for indirect or direct damages arising because of incomplete or erroneous information in this documentation, as well as in its delivery and usage, is excluded.

© 2015

BANDELIN *electronic* GmbH & Co. KG, Heinrichstrasse 3 – 4, Germany, 12207 Berlin,

Phone: +49-30-768 80 - 0, Fax: +49-30-773 46 99, info@bandelin.com

General

The equipment, the accessories and the preparations are to be used in accordance with the Instructions for Use and/or the product information.

The instructions are part of the scope of delivery and are to be stored in the vicinity of the device for later reference. This also applies if possession of the device is transferred elsewhere.

Before the device is put into operation, these Instructions for Use are to be read carefully and completely in order for the user to become familiarised with all functions.

The warnings and safety precautions (chapter 1.5) must always be heeded during use.

The manufacturer will not assume any responsibility for the device's safety or functional ability in the event of improper handling or usage contrary to the intended purpose. In the event of unauthorised alterations/modifications, both the warranty claim and the CE conformity will no longer be valid.

If service is required, please contact the specialist dealer in charge or the manufacturer.

Symbols used:









Symbol	Significance	Explanation
	Danger	Identifies information that could signify a risk to life and limb, especially through electric shock, if not observed.
	Caution	Identifies information that is to be observed and adhered to without fail, to prevent damage to the device and danger to the user.
	Warning	Warning of hot surface.
	Important	Identifies information that is important for execution.
	Note	Identifies information provided for explanatory purposes.
	Do not grip inside	For health reasons, touching the oscillating fluid is prohibited.
	Wear ear protectors	For health reasons, standing for long periods of time in the vicinity of the device without ear protectors is prohibited.
	Operating sequence instructions	Identifies instructions that are to be followed in the described sequence.

Table of Contents

1	Product description	6
1.1	Mode of operation	7
1.2	Purpose	7
1.3	CE conformity	7
1.4	Technical data, general	8
1.4.1	Tank size RM 16	9
1.4.2	Tank size RM 40	10
1.4.3	Tank size RM 75	11
1.5	Warnings and safety precautions	12
2	Preparation	13
2.1	Scope of delivery	13
2.2	Set-up / assembly	13
2.3	Start-up	14
3	Operation	15
3.1	Operating elements	15
3.1.1	Ultrasound	15
3.1.2	Heating	16
3.2	Miscellaneous functions - not applicable -	16
3.3	Device signals - not applicable -	16
4	Use	17
4.1	Instructions for use	17
4.2	General use	18
4.3	Further information	21
4.3.1	Degassing	21
4.3.2	Disposal of sonication fluids	21

5	Maintenance and cleaning	22
5.1	Cleaning and care	22
5.2	Warehousing / storage	22
6	Maintenance and repair	23
6.1	Maintenance	23
6.2	Functional checks	23
6.3	Error analysis	24
6.4	Customer service	24
6.4.1	Repairs and service	24
6.4.2	Decontamination certificate	25
6.4.3	Replacing fuses	25
7	Accessories	26
7.1	Required accessories	26
7.2	Optional accessories	27
7.3	Chemical preparations - Recommendations	29
8	Consumable materials - not applicable -	32
9	Taking the unit out of service	32
10	Key words - not applicable -	32

Informative appendices

A	Example of a possible cleaning sequence using peripheral devices
B	Decontamination - sample copy

1 Product description

Ultrasonic and rinsing bath, type SONOREX TECHNIK RM

The exact type specification and serial number are found on the type plate, on the rear side of the ultrasonic bath.

Product features:

- Stainless steel oscillating tank (1) with high-grade PZT high-performance ultrasonic systems, ultrasound frequency 40 kHz
- Easy-to-clean stainless steel housing (2)
- Filling level mark for safe filling (3)
- Weir/overflow (4) with ball valve to produce a liquid circuit.
- Legs (5) for a secure position
- Outlet with 3-way ball valve (6) for easy draining/filling of the bath fluid
- Depending on the model, with time switch (type "U") for 1 - 15 min or continuous operation (7) and/or with heating (type "H") (8).



SONOREX TECHNIK RM 40 UH

1.1 Mode of operation

SONOREX ultrasonic baths use the effect of cavitation. Under their oscillating tank bottoms they contain piezoelectric transducers, the energy of which is transferred to the bath liquid with ultrasound frequency as mechanical oscillations. As a result, microscopically small bubbles are continuously formed in the bath liquid, which release energy upon imploding and generate local microcurrents. This process is called cavitation. During the cleaning process, it causes contamination to be "blasted" from the hard surfaces of the objects being treated. At the same time, dirt particles are removed and fresh bath liquid flows in.

During sonochemical processes, cavitation may have a catalytic effect, e.g. with the production of stable emulsions or the rapid degasification of fluids with a high gas content.

1.2 Purpose

SONOREX TECHNIK ultrasonic baths are intended for the sonication of aqueous liquids. They work on the basis of low-frequency ultrasound and can be used in versatile ways. Their main application is the gentle and intensive cleaning of objects of diverse shapes, types and sizes.

Sonication is always carried out together with a suitable preparation that is added to the bath fluid. In order to use the device as intended, a basket or other inset beaker is required, into which objects are placed during sonication. An optimum diffusion of the ultrasound can only be guaranteed in this manner.

The unit is operated from the front. The SONOREX TECHNIK ultrasonic bath is usually operated with the unit placed on a table.

1.3 CE conformity

The units fulfill the CE marking criteria of the following European Directives:

- "Low-voltage directive"
- "Electromagnetic compatibility" directive

in their currently valid versions.

A declaration of conformity can be requested from the manufacturer by providing the serial number.

1.4 Technical data, general

The ultrasonic and rinsing baths are interference-free and marked with a C E

Compliance with limit values pursuant to EN 61010... .

Nominal voltage: 230 V~ ($\pm 10\%$) 50/60 Hz, cable length 2 m

HF frequency: 40 kHz

Tanks: Stainless steel 1.4571 (V4A), 2 mm, welded, with weir

Serial number: see type plate on rear of device

Degree of protection: IP 32 according to DIN EN 60529

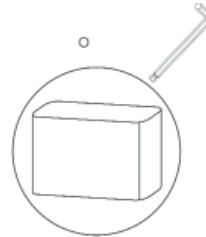

Protected against access to hazardous parts with tools; protected against solid objects with a diameter of 2.5 mm or larger

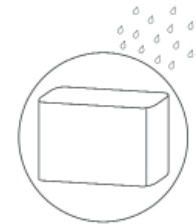

Protected from dripping water up to 15° from its vertical axis

Environmental conditions pursuant to EN 61 010-1

Overvoltage category: II

Degree of contamination: 1

Permissible ambient temperature: 5 to 40 °C

Permissible relative humidity up to 31 °C: 80 %

Permissible relative humidity up to 40 °C: 50 %

Condensation not allowed.

Only for indoor operation.

1.4.1 Tank size RM 16

		RM 16 UH	RM 16 H	RM 16 U	RM 16
Exterior dimensions (l × w × h)	mm	365 × 340 × 390			
Interior dimensions (l × w × d)	mm	325 × 275 × 200			
Capacity	l	20			
Filling volume	l	15			
Operating volume	l	13			
Inlet and outlet		3-way-ball valve G ½			
Weir outlet		G 1 outside			
Heating power	W	800	800	-	-
Fuses (heating)		-	F6A Ø6.3×32	-	-
HF frequency	kHz	40	-	40	-
Fuses (generator)		F6.3A Ø5×20	-	F2A Ø5×20	-
Peak ultrasonic output*	W	1200	-	1200	-
HF power	W _{eff}	300	-	300	-
Weight (net)	kg	16.0	15.0	15.0	14.0
Order No.		8200	8202	8201	8203

* In order to improve the effect, the ultrasound is modulated, resulting in the HF power value increasing 4-fold as peak ultrasonic power.

1.4.2 Tank size RM 40

		RM 40 UH	RM 40 H	RM 40 U	RM 40
Exterior dimensions (l × w × h)	mm	540 × 340 × 500			
Interior dimensions (l × w × d)	mm	480 × 300 × 300			
Capacity	l	45			
Filling volume	l	36			
Operating volume	l	30			
Inlet and outlet		3-way-ball valve G $\frac{3}{4}$			
Weir outlet		G 1 outside			
Heating power	W	1300	1300	-	-
Fuses (heating)		F10A Ø6.3×32	F10A Ø6.3×32	-	-
HF frequency	kHz	40	-	40	-
Fuses (generator)		F2A Ø5×20	-	F2A Ø5×20	-
Peak ultrasonic output*	W	2000	-	2000	-
HF power	W_{eff}	500	-	500	-
Weight (net)	kg	26.0	23.0	25.0	22.0
Order No.		8210	8212	8211	8213

* In order to improve the effect, the ultrasound is modulated, resulting in the HF power value being increased 4-fold as peak ultrasonic power.

1.4.3 Tank size RM 75

		RM 75 UH	RM 75 H	RM 75 U	RM 75
Exterior dimensions (l × w × h)	mm	640 × 540 × 530			
Interior dimensions (l × w × d)	mm	580 × 500 × 300			
Capacity	l	90			
Filling volume	l	70			
Operating volume	l	60			
Inlet and outlet		3-way-ball valve G ¾			
Weir outlet		G 1 outside			
Heating power	W	1950	1950	-	-
Fuses (heating)		F10A Ø6.3×32	F10A Ø6.3×32	-	-
HF frequency	kHz	40	-	40	-
Fuses (generator)		F4A Ø5×20	-	F4A Ø5×20	-
Peak ultrasonic output*	W	4000	-	4000	-
HF power	W _{eff}	1000	-	1000	-
Weight (net)	kg	42.0	37.0	41.0	36.0
Order No.		8220	8222	8221	8223

* In order to improve the effect, the ultrasound is modulated, resulting in the HF power value being increased 4-fold as peak ultrasonic power.

1.5 Warnings and safety precautions

General

- Keep the ultrasonic/rinsing bath out of the reach of children and of persons who have not been instructed in its operation by reference to these instructions.
- We do not guarantee against damage to the ultrasonic/rinsing bath or oscillating tank, or to the objects to be treated, as a result of use of inadequate disinfection agents or detergents.
- Keep the surface of the ultrasonic/rinsing bath and operating elements clean and dry.
- Do not expose the ultrasonic/rinsing bath to corroding influences.
- Only move the ultrasonic/rinsing bath when it is empty.
- Empty the ultrasonic/rinsing bath only while turned off.
The tank is emptied with no peripheral devices connected, using the three-way ball valve. To do so, turn the handle in the direction of the outlet.
- Ultrasonic baths adhere to prescribed EMC limit values, such that it can be assumed that the electromagnetic radiation emanating from the units is harmless to humans. A binding statement for wearers of implants can only be made at the place of work and together with the implant manufacturer. In case of doubt, information regarding the allowable electromagnetic exposure level is to be obtained from the implant manufacturer.
- If the unit is passed on to others, the operating instructions with the safety instructions must also be handed over.

Operation and transport

- Observe ambient and set-up conditions, see chapter 1.4.
- Only plug in the ultrasonic/rinsing bath to an outlet with a grounded socket.
- Do not operate the ultrasonic/rinsing bath without fluids.
- Do not stand or lay any objects on the tank bottom, accessories must be used, see chapter 7.
- Do not immerse any parts of the body (e.g. hands, feet) or living beings (animals or plants) in the tank; in particular, do not immerse them in the ultrasonic fluid during ultrasound operation. Danger: Ultrasound has a cell-destroying effect.
- In the event of continuous activity within a 5 m radius, adequate hearing protection must be used. Danger: Hearing loss possible if not wearing hearing protection during operation – the typical ultrasound cavitation noise can be perceived as very unpleasant.
- When preheating the bath liquid, stir at least every 30 min. or switch on the ultrasound. Danger: Scalding due to retardation of boiling.
- Do not leave the ultrasonic/rinsing bath unattended while in operation.



Damages and defects

- If damage to the ultrasonic/rinsing bath is detected, do not connect the ultrasonic/rinsing bath to the mains.
- In the event of defects, disconnect the power plug immediately.
- Repairs must only be conducted by authorised skilled personnel or by the manufacturer.
- Defective parts may only be replaced with original SONOREX parts.

2 Preparation

Carefully unpack the ultrasonic/rinsing bath and accessories and inspect them for completeness or possible transportation damages. If any damages or defects are found, these must be immediately notified in writing to the transportation company and to the supplier.

Before startup, the ultrasonic bath is to be left to stand at its operating location for 2 hours so that it may adapt to the ambient conditions.

2.1 Scope of delivery

1 Ultrasonic/rising bath, see delivery note

1 Accessories kit

1 Instructions for Use manual

Additional accessories according to order - see delivery note

2.2 Set-up / assembly

- Place the ultrasonic/rinsing bath on a firm, level and dry surface. In doing so
 - observe the maximum weight of the tank, including liquids. For net weight, see technical data, chapters 1.4.1 to 1.4.3.
 - do not block the air supply below the tank.
 - guard against moisture and wetness - risk of electric shock.



Set-up

- Fully remove transportation aids (pallets, transport safety devices).
- Set up the ultrasonic/rinsing bath in a dry room.

- Mount the separately-packaged ball valves for each tank as follows:

1. Screw the counter nut onto the threaded sleeves 1 at the tank outlet (3-way ball valve) and tank overflow (ball valve), then seal with the white PTFE tape provided, applying several turns of tape to the right.
2. Tape the hose socket threads 2 with PTFE sealing tape.
3. Screw the hose sockets 2 into the ball valve outlets 3, use the appropriate spanner.
4. Screw the ball valve 3 onto the threaded sleeves and tighten with the counter nut 4.

Caution: Do not screw the ball valve up to the limit stop or back it off by rotating it slightly to the left, this will cause the PTFE tape to lose its sealing effect.

5. Close ball valve, turn the lever 5 upwards.

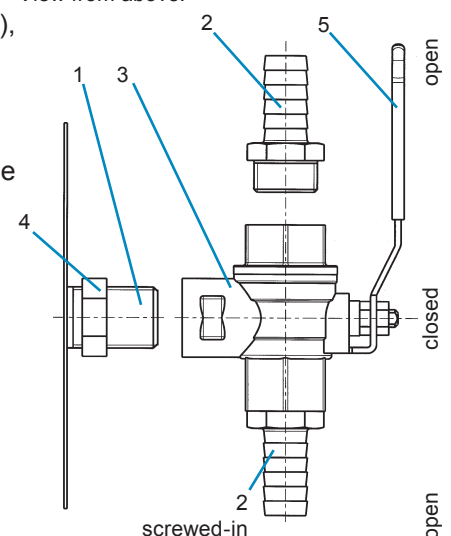

2.3 Start-up

- Thoroughly rinse the ultrasonic or rinsing bath's oscillating tank with water before its first use.
- Verify that the control buttons are in the "off" position, i.e. the switch indicator is at the top, then connect the bath to the mains.
- Conduct function test on the ultrasonic bath – briefly plug in the ultrasound (maximum of 1 to 2 seconds), a hissing noise should be heard. Set to "0" once again.
- Hang accessories in the ultrasonic bath and place lid on top.

- Connect peripheral devices if required – see additional documentation.

3 Operation

3.1 Operating elements

The ultrasound and the heating system are operated from the front:

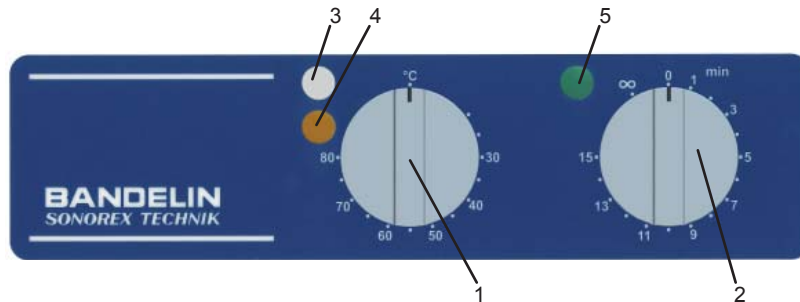

- 1 Turning knob for Heating ON / OFF incl. adjustment control
- 2 Turning knob for Ultrasound ON / OFF with preset time
- 3 White control light (Heating is activated)
- 4 Yellow control light (Heating in operation)
- 5 Green control light (Ultrasound in operation)

The layout of the turning knobs depends on the bath.

3.1.1 Ultrasound

The ultrasound is operated through the turning knob (time switch).

Timed operation:

- Turn knob to the right
 - range of time 1 - 15 minutes
 - Green control light is illuminated.
 - Once the time has elapsed, the time switch automatically turns off.
- By turning the knob back, the operating time is shortened or the ultrasonic bath is turned off.

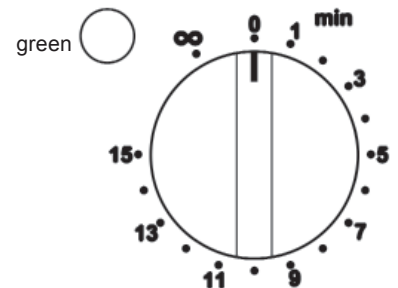

Continuous operation:

- Turn knob to the left
 - Setting ∞
 - Green control light is illuminated.
 - The ultrasonic bath does not turn off automatically; to switch it off turn the knob to the right, back to "0".



Notes

- Even while turned off, the ultrasonic bath may remain connected to the mains. It can be disconnected by pulling out the mains plug.
- An “engaging” of the time switch is barely felt if mains voltage is not present, e.g. if the mains plug is disconnected or the fuse is blown. The time switch only works if mains voltage is present.

3.1.2 Heating

The heating is operated through the turning knob (heating).

- Turn knob to the right
 - Temperature range 30-80 °C:
 - The yellow and white control lights are illuminated.
 - The yellow control light goes out when the set temperature is reached.
 - To turn it off, turn the knob left back to "°C".

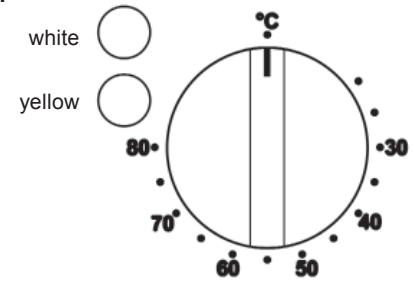

Notes:

- The heating system works independently from the ultrasound.
- The heating automatically turns on every time that the bath temperature drops below the set temperature.

3.2 Miscellaneous functions - not applicable -

3.3 Device signals - not applicable -

4 Use

Sonication or rinsing always take place directly in the tank. For this purpose, the objects are placed in a basket and hung inside the tank which is filled with bath fluid.

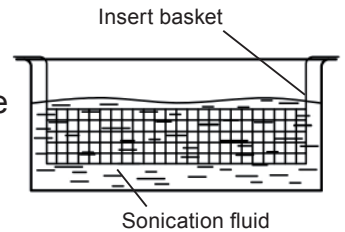

4.1 Instructions for use

Instructions – filling

- Check that all ball valves are closed.
- Ultrasound and heating must be turned off.
- Do not fill ultrasonic tank with hot water. Maximum filling temperature: 50 °C.
- At least drinking-quality water must be used to fill the oscillating tank.
- Water without additives is not suited for sonication. BANDELIN recommends the TICKOPUR or STAMMOPUR preparations.
- The fill level must always be at or slightly above the filling level mark.



A low fill level will damage the ultrasonic bath!

This may happen when used for extended periods, for example as a result of evaporation. In such cases, the ultrasound and possibly the heating must be switched off (controller on 0). Once the tank is filled up, the ultrasound and the heating, if applicable, can be switched back on.

- When using with a liquid circuit (with FA, OX, WA or cascade pipes) the additional fill volume of the peripheral devices must be taken into account:
Fill the ultrasonic bath with water and cleaning concentrate (in the appropriate dose!) up to the weir's toothed edge ⇒ Follow the dosing instructions for the concentrate used. Also fill all additional tanks up to the weir with municipal or DI water.



- Do not use any combustible fluids (e.g. benzine, solvents) or chemicals that contain or separate out chloride ions (some disinfectants, household cleaners and dishwashing detergents) for sonication in the stainless steel tank.
- When using preparations, the safety instructions included in the product leaflets must strictly be adhered to.
- Replace used sonication fluids, do not refresh by adding fluids.

Notes - Inserting objects

- Fully remove air bubbles from cavities (e.g. blind holes).

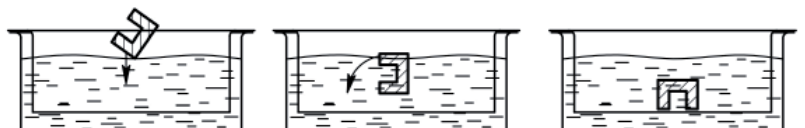

Notes - Temperature and heating

- Heated fluids intensify the ultrasound effect. Experience has shown that the best results are obtained with a bath temperature of 50 to 60 °C. At higher temperatures, the effect of the ultrasound cavitation decreases again, however¹.
- In order to save time during use, the bath fluid may be preheated during degassing.
- Ultrasound energy warms up the sonication fluid (even without additional heating). Through continuous sonication and/or by covering the oscillating tank, the fluid temperature may increase faster and even rise above the maximum adjustable value of the thermostat (80 °C). For this reason, check the temperature when treating temperature-sensitive components.
- For an optimum bath temperature, observe the specifications from the preparation manufacturer!
- To protect the electronic components inside the ultrasonic bath, the ultrasound output is reduced upon reaching a critical temperature in order to inhibit a further increase in the interior temperature.
- The fluid in the oscillating tank may not exceed a maximum operating temperature of 100 °C.
- Cover the ultrasonic bath when in continuous operation so that not too much bath liquid evaporates.
- For safety reasons ultrasonic cleaning baths and rinsing baths should be covered when not in operation, to prevent operating and external personnel from inadvertently coming into contact with the bath liquid or being injured by liquids that are still hot.

4.2 General use

Step 1: Fill oscillating tank

The oscillating tank is filled with water and a suitable preparation to reduce the surface tension, see chapter 7.3.

- Fill 1/3 of oscillating tank with water.
- Add dosed preparation to the oscillating tank.
- Fill carefully up to the filling level mark, avoid the formation of foam as much as possible.

Step 2: Degassing the fluid

Freshly-filled bath fluid or fluid that has remained in the oscillating tank for a longer period of time must be degassed prior to use. See also chapter 4.3.1.

- Remove basket and other accessories from the oscillating tank.
- Place lid on top.
- Turn on the ultrasound with the turning knob and sonicate for 30 min for degassing, see chapter 3.1.1.

¹ MILLNER, R.: Wissenspeicher Ultraschalltechnik, Fachbuchverlag publishing house, Leipzig 1987

Step 3: Preheat fluid

In ultrasonic baths with integral heating, the fluid may be preheated independently of the ultrasound. This increases the ultrasound effect, especially when removing fats, oils and polishing paste residue, and shortens the duration of the subsequent ultrasound.

- Remove basket and other accessories from the oscillating tank.
- Place lid on top.
- Using the turning knob, set the desired temperature, see chapter 3.1.2.
- For an even warming of fluids, stir the fluids or switch on the ultrasound for a few minutes now and then, otherwise there will be a retardation of boiling – risk of scalding!

Step 4: Insert objects to be treated

Before every sonication it is necessary to check whether the sonication fluid needs to be cleaned or replaced.

- Hang the insert basket with the items to be sonicated.
- Check that the objects to be treated are fully covered with fluid.
- With every object inserted, the fill level is to be controlled.

For cleaning tasks

Place the objects to be cleaned in the appropriate accessories, in doing so please note:

- Evenly distribute parts, do not stack them.
- Overloading the basket will reduce the ultrasound effect (the ultrasound is absorbed).
- Place the more heavily soiled side facing downward.
- Parts with joints are to be fully opened before placing inside.
- Fragile parts may not touch each other.
- Due to the design, the ultrasound effect is weaker on the outlet side. Heavily contaminated objects should not be placed in the basket over the outlet.

Step 5: Ultrasound - Operation

Fundamentally, the sonication time is to be as short as possible in order to protect the objects to be treated and the oscillating tank.

In the case of stubborn residue, conduct sonication for a longer time if necessary.

- Place lid on top.
- Using the turning knob, set the desired sonication time, see chapter 3.1.1.

Step 6: Remove treated objects

After sonication, the objects are to be removed from the ultrasonic bath. Allowing them to remain any longer in the bath fluid may damage them.

- Switch off the ultrasound.
- Remove the basket from the tank and place it securely on a horizontal surface.



Depending upon the set temperature or the duration of sonication, the baskets and objects may be hot!

- After the cleaning processes, rinse the treated objects with water of at least drinking quality. Visually review the sonication results.
- Before the next sonication, verify the service life (see chapter 4.3.2) of the bath fluid. Heed the specifications of the preparation manufacturer. If necessary, empty the oscillating tank.

Step 7: Empty the oscillating tank.

Layers of contamination on the tank bottom reduce the ultrasonic output.

The oscillating tank is to be emptied after a long period of use or sonication of heavily soiled objects, see chapter 4.3.2.

- Switch off the ultrasound.
- Empty the oscillating tank by pointing the 3-way ball valve handle in the direction of the outlet to open it.
- After emptying the oscillating tank, thoroughly rinse it. Wipe dry with a soft cloth. For additional care instructions, see chapter 5.

4.3 Further information

4.3.1 Degassing

Degassing the sonication fluid increases the ultrasound effect.

Freshly filled-in fluid or fluid that has remained in the oscillating tank for a longer period of time must be degassed prior to use. Gases dissolved in the fluid (e.g. oxygen) are reduced through degassing and the ultrasound effect is thus significantly improved.

The cavitation noise changes during degassing, loud degassing noises disappear at the end of the degassing process and the ultrasonic bath appears to work more quietly.

A lower noise level, however, does not mean a reduction in ultrasonic power. It rather means the end of the degassing process and an improvement in the ultrasound effect.

4.3.2 Disposal of sonication fluids

The working solution should be disposed of pursuant to the specifications of the product leaflet and the label. All aqueous solutions made by DR. H. STAMM GmbH are prepared pursuant to the regulations of the German Washing and Cleansing Agents Act, are biodegradable, and may be discharged into the sewerage as working solutions. Strongly acidic and strongly alkaline fluids are to be previously neutralised pursuant to technical data sheet specifications. The manufacturer specifications for the corresponding preparation should be observed.

During cleaning, materials hazardous to water such as oils, heavy metal compounds, etc., may be introduced to the working solution depending on the type of contamination. If the limit values are exceeded, the working solution must be reconditioned (removal of contaminants) or be disposed of as toxic waste.

Disinfecting and cleaning agents that become contaminated when used are considered "waste material" pursuant to the German Waste Act (AbfG) and may not be taken back by the manufacturer.

In every case, the statutory provisions and regulations of municipal wastewater plants must be adhered to. Information is provided by municipal wastewater plants as well as by environmental agencies.

5 Maintenance and cleaning

To achieve an optimum lifespan for the ultrasonic/rinsing bath, cleaning and maintenance should be conducted regularly.



CAUTION!

Disconnect the bath from the mains before each cleaning / maintenance.



Do not rinse or immerse the ultrasonic bath in water and do not expose it to splash water.

No guarantee is given for damages caused by the use of unsuitable disinfection agents or detergents.

5.1 Cleaning and care

Oscillating tank

The oscillating tank of an ultrasonic bath is a wear part.

It is continuously exposed to cavitation during ultrasound operation. Dirt particles remaining in the tank abrade and damage the tank surface due to the movement of the fluid, therefore

- Thoroughly and frequently rinse the oscillating tank with water and wipe dry with a soft cloth.
- Regularly remove residue and scum from the oscillating tank using a commercial stainless steel cleaning product without any abrasive additives.
- Do not use steel wool, scrapers or graters for cleaning / maintenance.
- Metal particles that remain on the stainless steel surface as well as rust particles from the water pipe system penetrate the passive protective layer of the stainless steel. The stainless steel is "activated" in this process and begins to rust. The extraneous rust produces localised corrosion of the stainless steel. For this reason, remove metal parts such as screws, filings, etc. from the oscillating tank, and immediately remove rust stains using a soft cloth and a commercial stainless steel cleaning product without abrasive additives.

Housing

- Do not use any abrasive cleaners, only commercial care products without abrasive additives.
- The exterior of the housing should be wiped down with a damp cloth and left to dry, or wiped dry.

5.2 Warehousing / storage

During long periods of non-use, the ultrasonic/rinsing bath must be stored in a cool, dry location. The lid should be placed on top in order to protect the bath from outside contamination.

6 Maintenance and repair

6.1 Maintenance

SONOREX TECHNIK ultrasonic/rinsing baths are maintenance-free.

For purposes of regular inspection, the following functional checks may be carried out.

6.2 Functional checks

Checking control lights

- Pursuant to chapters 3.1.1 and 3.1.2.

Checking the ultrasound and/or heating

The function can be checked using a standard wattmeter. It should be inserted between the ultrasonic bath's mains plug and the socket.

- Fill the tank with fluid, see chapter 4.2.
- For testing purposes, only the ultrasound or only the heating system should be plugged in. Next, the value displayed is to be compared with the corresponding value in the technical data (chapter 1.4) (tolerances $\pm 20\%$).

Checking the ultrasound effect

- For this check, it is recommended that a foil test be conducted (semi-annually). Ordinary aluminium foil is used to conduct the test. Next, a comparison is made with previously-generated foils, if applicable.
Detailed information available upon request.

6.3 Error analysis

SONOREX ultrasonic and rinsing baths are robustly constructed and designed for a high level of reliability.

Nevertheless, the possibility of a malfunction due to a defective component can never be fully discounted.

The following overview of possible sources of error should serve as an aid for error detection and elimination.

- Ultrasonic bath oscillates weakly, unevenly, or noise is too loud:
 - Has fluid been properly degassed? ⇒ Treat for 30 min.
 - Is it overloaded with objects to be treated? ⇒ Remove a few parts.
 - Uneven noises (wobbling) ⇒ No error - slightly adjust the fill level of the fluid.
- Heating system defective?
The ultrasonic bath can be readily operated without heating.
- Slight erosion visible on the bottom of the bath? ⇒ Natural wear.
Ultrasonic bath OK.
Strong erosion marks appear at the tank bottom
→ lead to loss of power

Any malfunctions must be communicated in writing to the manufacturer.

6.4 Customer service

If service is required, please contact your specialist dealer or Bandelin electronic to order spare parts or before sending in defective devices.

6.4.1 Repairs and service

If errors or defects are ascertained as a result of the functional check, and if it is impossible to rectify such errors, the ultrasonic bath may no longer be used. In such a case, please contact the supplier or the manufacturer:

BANDELIN electronic GmbH & Co. KG
Heinrichstrasse 3-4
12207 Berlin

Repair service:
Phone: +49-(0)-30 – 768 80 – 13
Fax: +49-(0)-30 – 76 88 02 00 13

E-mail:
info@bandelin.com

In the case of returns, the general terms and conditions for delivery and payment of BANDELIN electronic GmbH & Co. KG shall apply.
In addition, the ultrasonic bath must be cleaned and decontaminated (if necessary), see the upcoming chapter.

6.4.2 Decontamination certificate

If the ultrasonic/rinsing bath is sent back to the manufacturer for repairs (with accessories, if applicable), the form "Certificate of Decontamination" must be filled out and affixed to the packaging on the outside, in a visible spot.
If this form has not been filled out, we reserve the right to refuse receipt of the package in order to protect our employees.

The form can be downloaded from the Internet as a PDF file:
www.bandelin.com - Download ...
A sample copy can be found in the appendix.

6.4.3 Replacing fuses



CAUTION!

Repair work may only be carried out by authorised, qualified personnel or by the manufacturer. The manufacturer assumes no liability for unauthorised work performed on the ultrasonic bath!



The mains plug must be pulled out before opening the ultrasonic bath!
There is a risk of electric shock from live parts in the ultrasonic bath!

- Empty the ultrasonic/rinsing bath and disconnect from the mains.
- Carefully place it on its back side. Be careful not to bend the mains cable. We recommend that a pair of suitable wooden slats be placed under the tank while the replacement process is taking place.
- Unscrew the base plate, loosen it and open it.
- Unscrew and remove the cover.
- The fuses are situated on the circuit board.
- After inspection, replace only the defective fuses. The fuse values are listed under "Technical Data".
- Reassemble the ultrasonic bath following the reverse order.
- Turn the bath upright and reconnect the mains plug.
- The ultrasonic/rinsing bath is once again ready for operation.

7 Accessories

The proper accessories facilitate use of the ultrasound and also protect the oscillating tank and objects to be treated.

BANDELIN offers a broad range of accessories, see appendix.

Additional information may be obtained from our supplier, our sales representatives, or from our website.

No-obligation telephone consultation:
+49-(0)-30 – 768 80 – 0

Website:
www.bandelin.com

7.1 Required accessories

The baskets and basket holder, for example, are required accessories.

Do not stand or lay any objects directly on the tank bottom.

	Series RM 16	Series RM 40	Series RM 75
Stainless steel insert basket, bearing capacity up to 10 kg	MK 16 B*	MK 40 B*	MK 75 B*
Order No.	8408	8409	8416
Stainless steel basket, bearing capacity up to 40 kg	-	MK 40 S MK 40 BS**	MK 75 S MK 75 BS**
Order No.	-	8410 8411	8475 8429
Stainless steel lid	MD 16	MD 40	MD 75
Order No.	8440	8442	8444

* Baskets for using with and without lifting device.

** Baskets for lifting device.



7.2 Optional accessories

Optional accessories are drop plates, lifting devices, etc.

Accessories	Series RM 16		Series RM 40		Series RM 75	
	Type	Order No.	Type	Order No.	Type	Order No.
Drop plate between 2 tanks	TB 16	8400	TB 40	8401	TB 75	8402
Oscillation	MO 16.2	8306	MO 40	8303	-	-
Lifting device with oscillation	MB 16	8300	MB 40	8301	MB 75	8302
Tank rack for 2 tanks	WG 16-2	8506	WG 40-2	8508	WG 75-2	8517
Tank rack for 3 tanks	WG 16-3	8500	WG 40-3	8501	WG 75-3	8502
Tank rack for 4 tanks	WG 16-4	8507	WG 40-4	8509	WG 75-4	8518
Filtration with prefilter and main filter, including connection set	FA 16	8608	FA 40	8609	FA 75	8610
Oil separator incl. connection set	OX 16	8600	OX 40	8601	OX 75	8602
DI water treatment device incl. connection set	WA 16	8632	WA 40	8633	WA 75	8634
Cascade pipes between 2 rinsing tanks	KV 16	8450	KV 40	8451	KV 75	8452
Trough dryer	TO 16	8334	TO 40	8335	TO 75	8336

Detailed specifications can be found in the Operating Instructions for the respective device.

Lifting device with oscillation MB

The electrically-driven lifting device with oscillation facilitates the lifting and lowering of the goods basket. The cleaning efficiency is increased and loosened dirt particles are rinsed off.



Tank rack WG

Tank racks for positioning the lifting device are designed for 2 to 4 tanks.



Filtration FA

Thanks to continuous filtering of the loosened particles, the lifetime of the tank is increased and the cleaning power is preserved.



Oil separator OX

To be connected to the ultrasonic cleaning tank when cleaning very oily or greasy parts. Impurities that rise to the surface of the tank are led via the weir into the oil separator, where they are separated by gravity.



DI water treatment device WA

To be connected to a rinsing tank. Used to eliminate any water residue that could leave spots on the treated objects during the drying process.



Trough dryer TO

The treated objects are dried after rinsing, to quickly remove any residual moisture.



7.3 Chemical preparations - Recommendations

Ultrasound applications require special preparations that are suitable for use with ultrasound, i.e. cavitation-conducive, biodegradable, easily disposable, gentle to the material and long-lasting.

BANDELIN recommends the TICKOPUR or STAMMOPUR concentrates by DR. H. STAMM GmbH, which have been especially developed for ultrasound use and which utilise the ultrasound optimally.

Additional information may be obtained from our supplier, our sales representatives, or from our website.

No-obligation telephone consultation:

+49-(0)-30 – 768 80 – 280

Website:

www.dr-stamm.de



IMPORTANT!

- When using preparations, the safety instructions on the label and in the respective product leaflet must be strictly adhered to.
- Keep the preparations out of the reach of children and also of persons who have not been instructed in their use by reference to the product information.
- Do not ingest or inhale the preparations, and do not allow them to come into contact with the eyes or skin.
- Specimens in powder form may only be used in fully-dissolved form.

Depending on the cleaning task, the best cleaning results can be achieved when using the following TICKOPUR preparations.

Contamination	Objects to be cleaned	Cleaning concentrate	Litres	Order No.
Universal cleaner				
General contamination, drilling, grinding, polishing and lapping residue, oil- and grease-based residue, soot, ink, etc.	Metal, glass, ceramics, plastic, rubber, windows, goggles, E-filters, respiratory masks (EXAM certificate No.: 5734/06) etc. Caution with tin and zinc.	TICKOPUR R 33 Universal cleaner with corrosion protection for Service, Industry, Technology and Laboratories, gentle to material, mildly alkaline, pH 9.9 (1%) application 1-5 %	2 l	883
			5 l	831
			25 l	835
			200 l	837
Neutral cleaner, gentle				
Light drilling, grinding, polishing and lapping residue, dust, soot, oil and grease contaminants, etc.	Metal, glass, ceramics, plastics, rubber, etc.	TICKOPUR R 30 Neutral cleaner with corrosion protection, gentle to material, neutral, pH 7 application 1-5 %	2 l	879
			5 l	811
			25 l	812
			200 l	814
Special acid-based cleaner				
Mineral residue, flash rust, grease, oils, waxes, pigments; drilling, grinding, polishing and lapping residue, etc.	Metal, glass, ceramics, plastics, rubber, etc.	TICKOPUR TR 3 Special cleaner based on citric acid, gentle to the material, phosphate-free, with corrosion protection, mildly acid, pH 3.0 (1 %) application 5 %	2 l	923
			5 l	935
			25 l	937
			200 l	973

Contamination	Objects to be cleaned	Cleaning concentrate	Litres	Order No.
Heavy mineral residue (limescale, silicates, phosphates, cements, etc.), rust, temper colors, metal oxides, grease and oil films, etc.	Steel, stainless steel, precious metals, glass, ceramics, plastic, rubber. Not for light or non-ferrous metals, tin, zinc.	TICKOPUR R 27 Special cleaner based on phosphoric acid, for decalcification and rust removal, with corrosion protection, acidic, pH 1.9 (1 %) application 5 %	2 l	874
			5 l	816
			25 l	817
			200 l	826
Special acid-based cleaner, demulsifying				
Mineral residue, flash rust, grease, oils, waxes, pigments; drilling, grinding, polishing and lapping residue, etc.	Metal, glass, ceramics, plastics, rubber, etc.	TICKOPUR TR 2 Special demulsifying cleaner based on phosphoric acid, gentle to the material, with corrosion protection, mildly acidic, pH 3.6 (1 %) application 0.1 - 5 %	2 l	866
			5 l	893
			25 l	895
			200 l	851
Special alkaline cleaner				
Resinous flux, soldering pastes, ionic and non-ionic residue; drilling, grinding, polishing and lapping residue, fingerprints, grease, oils, etc.	Non-ferrous and light metals, steel, stainless steel, glass, ceramics, plastics, rubber, assembled and unassembled PC boards, soldered frames, electronic components, modular components, etc.	TICKOPUR TR 14 Flux remover, tenside-free, non-foaming, gentle to the material, phosphate-free, alkaline, pH 10.7 (1 %) application 10 %	2 l	873
			5 l	861
			25 l	862
			200 l	864
Distillation residue, organic and inorganic residues, oil and grease contaminants, etc.	Metals including burnished metals, glass, ceramics, plastics, rubber, etc. Especially for galvanic, laser and analytical applications. Dilute with DI water.	TICKOPUR R 32 Special cleaner, free of complexing agents, gentle to the material, with corrosion protection, mildly alkaline, pH 11.1 (1 % in DI water) application 0.25 - 5 %	2 l	882
			5 l	832
			25 l	834
			200 l	842
General soiling, oils, greases, distillation residue, organic and inorganic residues.	Steel, light and precious metals, ceramics, plastics, rubber, glass, optical glass, vertical and horizontal blinds. Caution with tin and zinc.	TICKOPUR R 36 Special cleaner, tenside-free, for analytical and technical laser applications, for the cleaning of blinds, gentle to the material, non-foaming, mildly alkaline, pH 9.9 (1%) application 0.25 - 5 %	2 l	884
			5 l	854
			25 l	856
			200 l	858
Special alkaline cleaner, demulsifying				
Oils, greases, waxes, pigments, flux, soldering pastes, drilling, grinding, polishing and lapping residue.	Steel, stainless steel, non-ferrous, precious and light metals, glass, ceramics, plastics, rubber, soldered frames.	TICKOPUR TR 7 Universal cleaner, demulsifying, for fast separation of oil and grease, mildly alkaline, pH 8.9 (1 %) application 0.1 - 5 %	2 l	867
			5 l	838
			25 l	840
			200 l	839
Gumming, coking residue, soot, oils, grease, waxes, pigments, coatings; drilling, grinding, polishing and lapping residues, etc.	Steel, stainless steel, glass, ceramics, plastics, rubber. Not for light alloys, tin, zinc. Non-ferrous heavy metals may become corroded.	TICKOPUR TR 13 Intensive cleaner, demulsifying against stubborn residue, free of phosphates and silicates, alkaline, pH 11.9 (1 %) application 0.1-10 %	2 l	872
			5 l	848
			25 l	850
			200 l	853

Contamination	Objects to be cleaned	Cleaning concentrate	Litres	Order No.
Alkaline cleaner for heavy soiling				
Gumming, soot, fats, oils, waxes, pigments, coatings, silicone oils, flux, oxide on non-ferrous and precious metals.	Non-ferrous and precious metals, iron, steel, glass, ceramics, plastics, rubber, test sieves, circuit boards for service. Caution with light metals.	TICKOPUR RW 77 Special cleaner with ammonia, phosphate-free, mildly alkaline, pH 9.9 (1 %) application 5 %	2 l 5 l 25 l 200 l	898 871 875 868
Coking residue, gumming, soot, pigments, greases, oils, waxes, silicone oil, coatings; drilling, grinding, polishing and lapping residues, etc.	Steel, stainless steel, glass, ceramics, plastics, rubber. Not for light metals, tin, zinc.	TICKOPUR R 60 Intensive cleaner, phosphate-free, strongly alkaline, pH 12.8 (1 %) application 2 - 20 %	2 l 5 l 25 l 200 l	896 818 819 845

All TICKOPUR preparations may also be used with submersion and wiping procedures.

Corrosion protection for ferrous metals

Materials	Properties	Concentrate	Litres	Order No.
Suitable for all ferrous metals such as cast irons, unprotected steels of diverse alloys.	Effective corrosion protection for use after cleaning with TICKOPUR agents, and subsequent rinsing with water. No formation of oily or greasy films.	TICKOPUR KS 1 Universal corrosion protection for all ferrous metals, free of solvents, neutral, pH 7.4 (1%) application 0.5 - 2 %	2 l 5 l	6011 6012

8 Consumable materials - not applicable -

9 Taking the unit out of service

If the ultrasound/rinsing bath no longer works, it must be appropriately disposed of. Some electrical components are considered to be toxic waste.



10 Key words - not applicable -

A Example of a possible cleaning sequence using peripheral devices

The SONOREX TECHNIK Modular Program can be assembled individually. It is comprised of efficient ultrasonic baths and rinsing tanks in different sizes with and without heating, as well as a large variety of additional equipment to facilitate work, extend the lifetime of the tanks, and dry the cleaned parts.

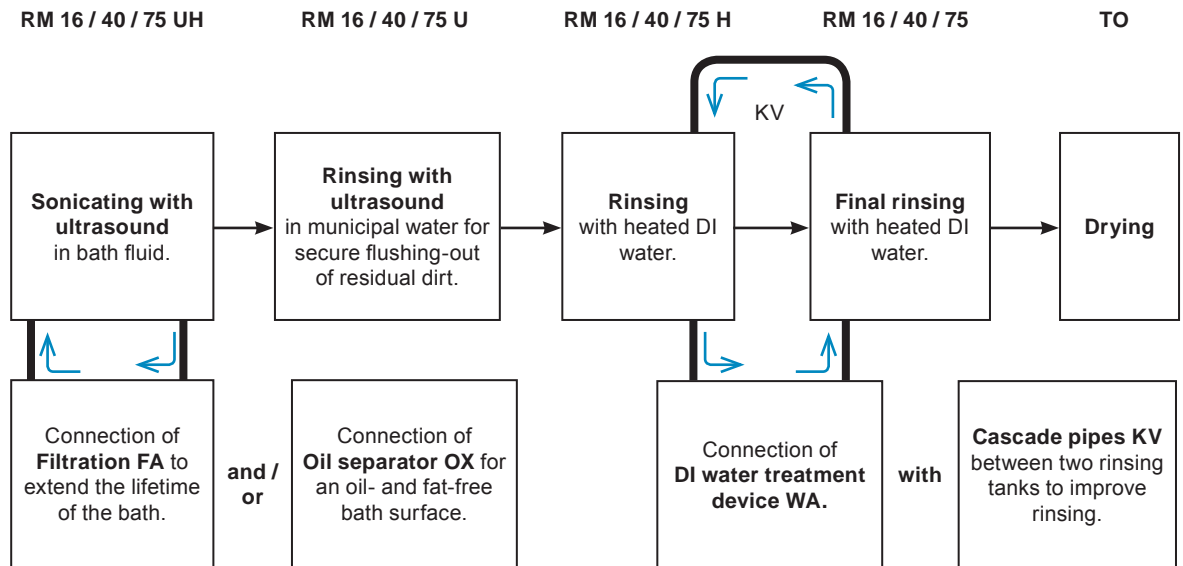

The electric lifting device with oscillation MB enables the lifting and lowering of the basket and provides an up and down motion in the bath during the cleaning process, improving the cleaning effect.

The modular system allows for individual assembly of these items depending on the cleaning task. A significant advantage is that the system can be expanded at any time.

B Decontamination - sample copy

Certificate of Decontamination

!!! CAUTION !!!

This form must be visibly affixed to the outside of the package!

This "Certificate of Decontamination" is intended to protect the occupational health and safety of our employees pursuant to the German Protection against Infection Act and trade association accident prevention regulations.

Please understand that we can only initiate work operations when this Certificate is submitted.

Before sending the unit back to us for inspection/repair, the unit and accessories must be cleaned pursuant to current laws and regulations and, if necessary, must also be disinfected with a surface disinfection agent listed by the VAH.

Device type: _____

Serial number: _____

Accessories _____

Device / accessories ...	
are not contaminated:	<input type="checkbox"/>
were cleaned before shipping?	<input type="checkbox"/>
are free of toxic matter?	<input type="checkbox"/>
have been decontaminated and/or disinfected and no longer pose a health risk?	<input type="checkbox"/>

With what type of toxic materials have the device / accessories been in contact with?

Corrosive

Biologically hazardous (e.g. microorganisms)

Toxic

Radioactive

None

Certificate of Decontamination

!!! CAUTION !!!

This form must be visibly affixed to the outside of the package!

Legally binding statement

I/We hereby declare that the device and accessories found in this package have been cleaned and/or disinfected pursuant to current laws and regulations and that the information provided in this declaration is correct and complete:

Company /
Institute:

Street and
number:

Postal code, city:

Department:

Name:

Telephone,
extension:

Fax:

Reason for return:

Thank you,
in this way
you help us to
reduce costs.

_____ Date

_____ Signature

_____ Company stamp

Note:

The Instructions for Use in this and other languages, as well as further information, can be found on the enclosed CD.