

Intraoral X-rays

X | line
IMAGING

Intraoral imaging
according to your needs



Made in Italy 

XDC



Precise setting for all exposures

Obtain the most appropriate exposure setting by selecting among 2 patient sizes, 9 programs and 3 detectors. Optional DAP available.



Excellent image quality

Finest focal spot of 0.4, DC technology and a wide range of preset exposure settings ensure excellent image quality.



The contrast you prefer

Get the image information you are looking for. Select the voltage 60 kV for perio application to reveal statement of ligaments or 70 kV for endo to see more hard tissue contours.



Integration flexibility

Available as a mobile and wall-mounted version. Four different extension arm lengths and possibility to place the timer remotely, for even greater installation freedom and ease of use.



Ergonomic positioning

Stable, easy to adjust arm ensures accurate and reliable positioning every time.

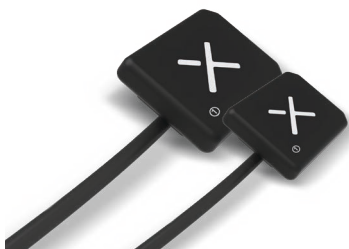

Perfectly compatible

The combined use of XDC and StarX PRO is a perfectly compatible solution to guarantee excellent image quality.

XDC is the perfect choice for demanding professionals.

This state of the art DC device with its modern design will fit perfectly into your dental studio and has the flexibility to give you excellent image quality in all your clinical cases. Its technology is fulfilling the highest standards for low dose digital imaging and with three presets, for all receptor types, is universally usable for digital sensors, phosphor plates or films.

Advanced DC technology

State of the art DC technology means excellent image quality and all the details you need for your diagnosis.

Integration flexibility

Different configuration possibilities for comfortable and reliable positioning.

Precise settings for all exposures

Automatic exposure setting in just 3 steps for fast and high quality imaging.



XDG

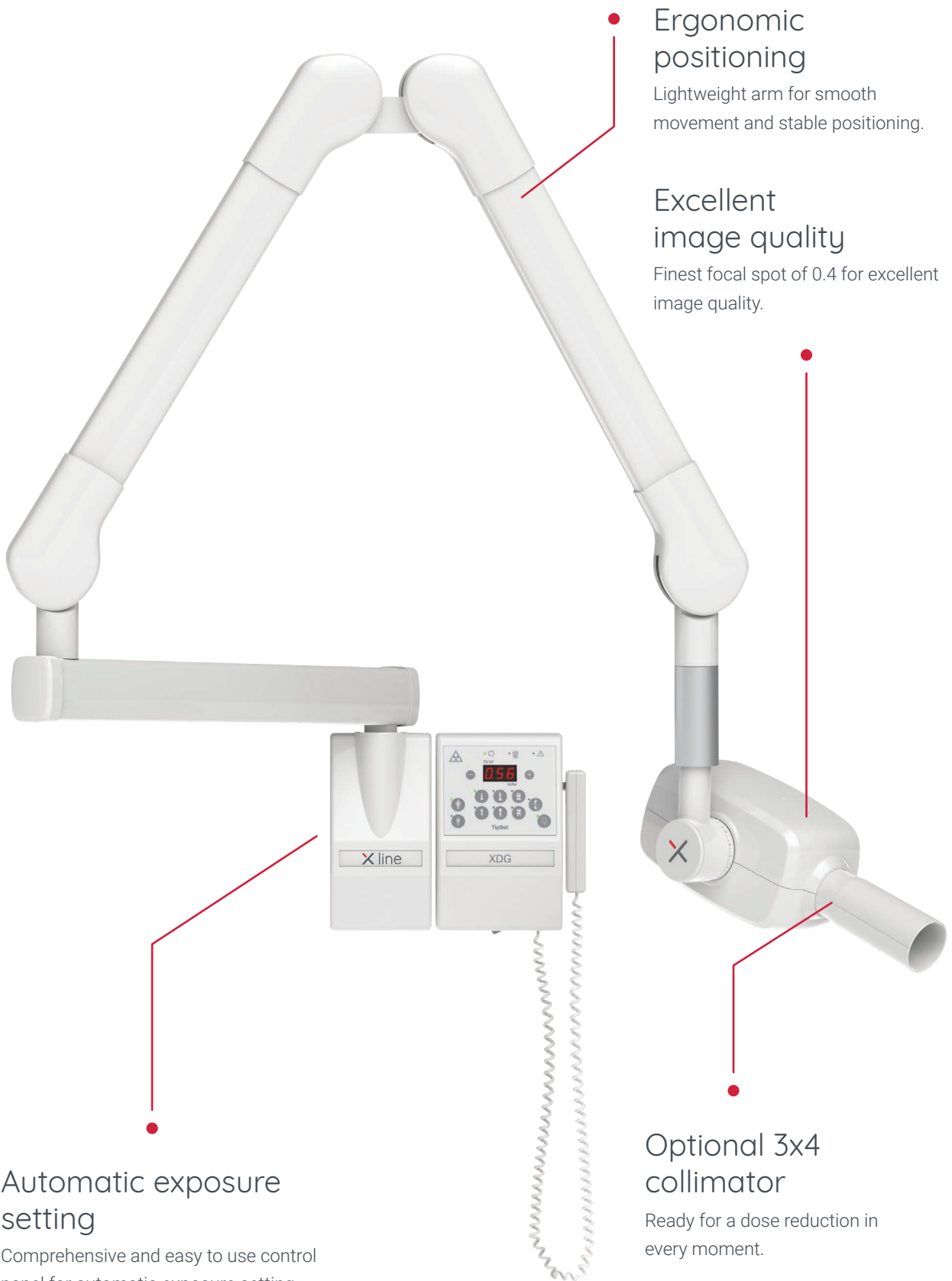

Ergonomic positioning

Lightweight arm for smooth movement and stable positioning.

Excellent image quality

Finest focal spot of 0.4 for excellent image quality.

Automatic exposure setting

Comprehensive and easy to use control panel for automatic exposure setting.

Optional 3x4 collimator

Ready for a dose reduction in every moment.

XDG is the choice of dentists worldwide, and has already proven its ease of use, precision and reliability.

It delivers high image quality even in the most demanding working conditions, both with high resolution receptors and the finest grain films.

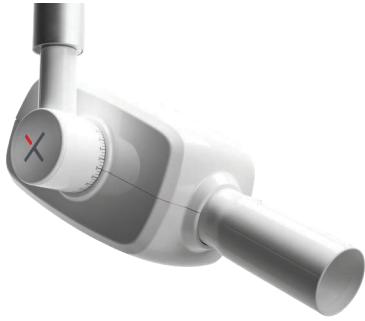

Excellent image quality

Obtain the most appropriate exposure setting by selecting among 2 patient sizes, 9 programs and 3 detectors. Optional DAP available.



Automatic exposure setting

Select program, patient size and receptor - mAs are automatically set ensuring accurate radiation dose.



Ergonomic positioning

The new arm design assures smooth movements and reliable positioning.



Remote solution

The remotely mounted timer and hand switch allow you to control the exposure from outside the X-ray room.

Options



4 different extension arms

Choose among 4 different extension arm lengths to make your intraoral unit perfectly fit into your dental studio. You can select standard 30 cm, 60 cm or 80 cm and optional 100 cm arm.



Rectangular collimator

FONA's rectangular beam limiting device (2x3cm or 3x4cm) permits significant dose reduction.



Mobile version

The mobile version is the ideal choice for dental clinics looking for maximum operational flexibility.



Collimator length

20/21 cm standard or 30 cm optional collimator available.



Remote hand switch

With a cable length of 10 m, the remote hand switch is easy to mount where needed.

Technical Specifications

	XDG	XDC
Generator	Alternating Current (AC)	Direct Current (DC)
Focal spot	0.4 (IEC 336/1997)	0.4 (IEC 336/1997)
Tube voltage, tube current	70 kVp, 3.5 mA	60/70 kV (selectable), 7 mA
Line voltage	120/230 V, 50/60 Hz	100/230 V, 50/60 Hz
Focus - skin distance	Standard 21 cm	Standard 20 cm (optional 30 cm)
Exposure time	0.21 - 11.2 mAs	0.01 - 3.2 s / 0.07 - 22.4 mAs
Patient Sizes	Adult, Child	Adult, Child
Number of anatomical regions	7	9

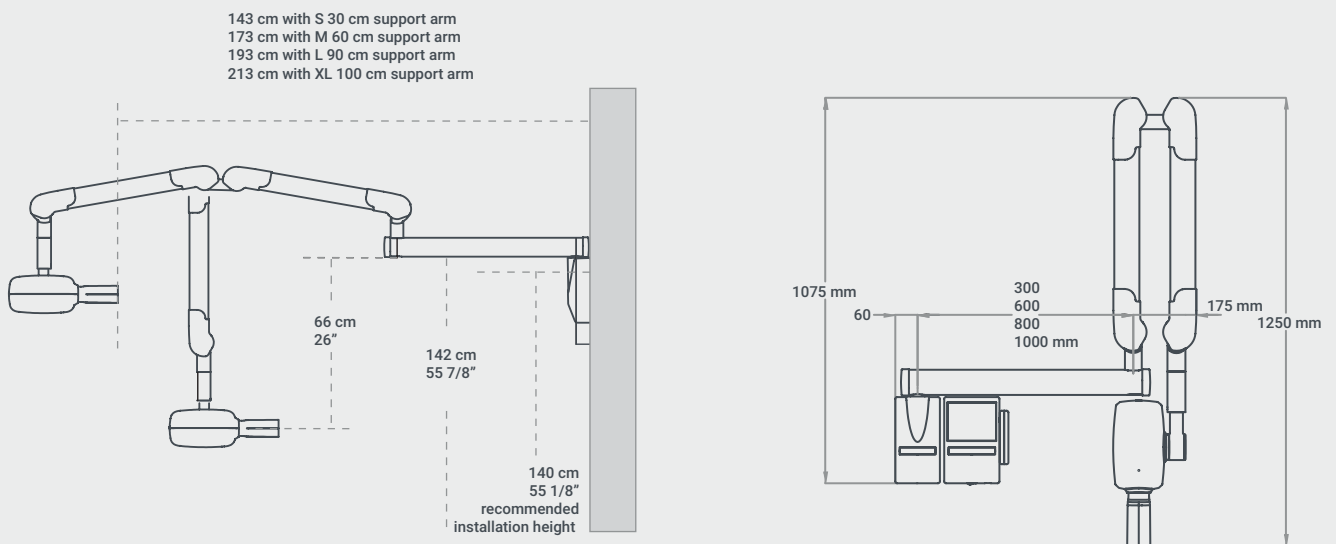

Wall mounted version available in four different extension arm lengths: 30cm, 60cm, 80cm, 100cm.

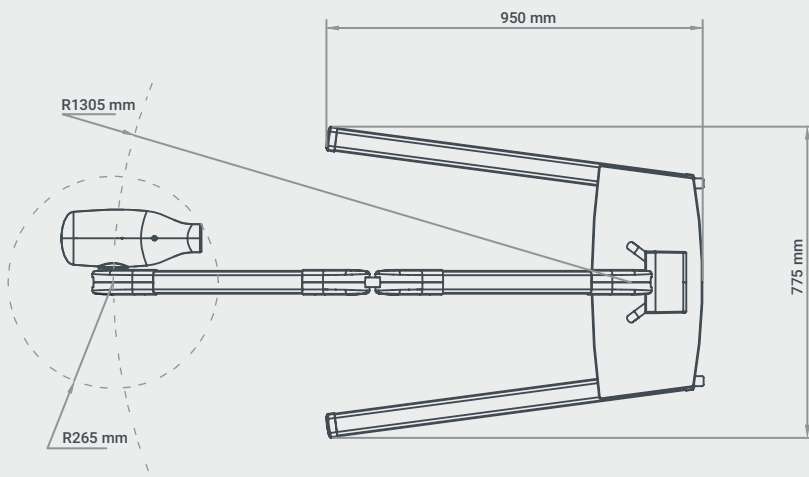

Italian Core International Mind

BlueX -> FONA -> Xline
+ 20 years of experience

Xline is the outcome of over 20 years of history in the dental sector, with two very important phases: BlueX, our origins, and Fona, our further internationalization and development. Xline is an evolution of BlueX and Fona, it's our asset to achieve new people, goals, markets and, especially, our idea of innovation. With more than 11.000 Extraoral units and 65.000 intraoral generators installed worldwide we combine Italian mastery, latest technologies and digital radiography to imagine, design and create extraoral and intraoral equipments for dental and veterinary clinics.

Latest technology and people caring

Digital dentistry

Intraoral **imaging**



Extraoral **imaging**



Intraoral **sensors**

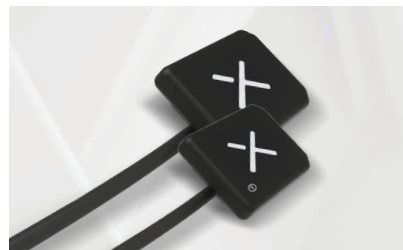

Based in **Italy**, available **worldwide**



Copyright Xline s.r.l., All rights reserved, Subject to technical changes and errors in text, BRO000, v1, ENG, 202401

Count on us

Distributed by:

ICONA

DESIGNED WITH YOU IN MIND

Trade Central Business Park
Unit 12/37 Keilor Park Drive
Keilor Park Vic 3042

Ph: 1300 442 662
sales@icona.net.au
www.icona.net.au

Headquarter

Xline s.r.l.
Via G. Galilei 18
20057 Assago (MI) - Italy



DIGITAL BROCHURE

Contacts

www.xlineimaging.com

CE
0051

