



NRU-230V-AWP/ NRU-240S-AWP Series

IP66 Waterproof AGX Orin Computer with 8x GMSL2, 4x PoE+ GbE, and 1x 10GbE Ports



Key Features

- Powered by NVIDIA® Jetson AGX Orin™ SoM bundled with JetPack
- IP66 waterproof and dustproof
- -25°C to 70°C fanless operation
- Support 8x GMSL2 automotive cameras via FAKRA Z connectors (NRU-230V-AWP)
- 4x PoE+ GbE and 1x 10GBASE-T via M12 X-coded connectors
- 2x isolated CAN 2.0, 1x RS232, and 1x isolated RS485 via M12 A-coded connectors
- 1x system monitoring port by automotive-grade MCU
- 8V to 48V wide-range DC input with built-in ignition power control

CONTACT US

GET QUOTE

Introduction

NRU-230V-AWP is a rugged, IP66 waterproof NVIDIA® Jetson AGX Orin computer targeting edge AI applications for harsh environments, ranging from roadside, food & chemical factories, mining, construction, agriculture, or harbor. It aims to redefine rugged Edge AI with waterproof features at an affordable cost through its streamlined mechanical design, standardized cable kit, and carefully selected waterproof connectors.

Powered by NVIDIA® Jetson AGX Orin, NRU-230V-AWP offers up to 275 sparse TOPS (INT8) AI inference and can transcode up to twenty-two 1080P video streams simultaneously. To meet versatile camera requirements for vision-based AI applications, NRU-230V-AWP not only offers 4x waterproof M12 PoE+ GbE ports for industrial GigE cameras or IP cameras, but it also provides 8x waterproof GMSL2 FAKRA ports for automotive cameras or industrial stereo cameras. Additionally, the waterproof Type-C connector provides 4K DisplayPort output for ADAS applications involving real-time surround-view awareness. A waterproof 10GbE port is also provided for high-speed data communication.

For in-vehicle deployment, NRU-230V-AWP is equipped with an 8V to 48V wide DC input range, ignition power control, 2x isolated CAN bus ports, 1x RS232 port, and 1x isolated RS485 port. It also features two mini-PCIe sockets for CAN/ COM/ WiFi modules and one M.2 B-key socket for 4G LTE/ 5G NR mobile communication module. In terms of storage, NRU-230V-AWP comes with 64GB eMMC on the Orin module and an M.2 2280 NVMe socket for fast SSD read/write speeds, along with two internal 2.5" SSD slots for storage expansion. Lastly, NRU-230V-AWP comes with a system monitoring port to report the latest power, thermal, and Jetson status via an onboard automotive-grade MCU for potential functional safety system design.

The integration of IP66 waterproof capability, AGX Orin AI performance, and rich onboard IO strikes a sweet spot between ruggedness, performance, and cost. It is an ideal waterproof edge AI platform for industrial vehicles, outdoor AMR, edge inspection, and roadside.

Specifications

	NRU-230V-AWP	NRU-240S-AWP		NRU-230V-AWP	NRU-240S-AWP
System Core			Storage		
Processor	NVIDIA® Jetson AGX Orin™ system-on-module (SOM), comprising NVIDIA® Ampere GPU and Arm Cortex-A78AE CPU		SATA HDD	2x internal SATA ports for 2.5" SSD installation	
Memory	32GB/ 64GB LPDDR5 (JAO 32GB/ JAO 64GB) @ 3200 MHz on SOM		M.2 NVMe	1x M.2 2280 M key NVMe socket (PCIe Gen4x2) for NVMe SSD	
eMMC	64GB eMMC 5.1 on SOM		Power Supply		
Panel I/O Interface			DC Input	8V to 48V DC input and ignition power control via M12 L-coded, 5-pin connector *	
GMSL Camera	8x GMSL2 FAKRA Z connectors Configuration A. 8x AC-IMX390 (2MP@30FPS) Configuration B. 8x AC-ISX031 (3MP@30FPS) Configuration C. 8x AC-IMX490 (5MP@30FPS)		Mechanical		
Ethernet Port	Port 1 to Port 4: 4x Gigabit Ethernet ports by Intel® I350 via M12 X-coded 8-pin connector Port 5: 1x 10 Gigabit Ethernet port via M12 X-coded 8-pin connector		Dimension	225 mm (W) x 194 mm (D) x 88.5 mm (H) (without rubber feet) 225 mm (W) x 194 mm (D) x 89.5 mm (H) (with rubber feet)	
PoE Capability	IEEE 802.3at PoE+ PSE for Port 1 to Port 4, 100 W total power budget		Weight	4.4kg (excluding wall-mount bracket)	
USB 2.0	2x USB 2.0 ports via M12 A-coded 8-pin connector		Mounting	Wall-mount bracket (standard)	
USB 3.2 + Video Port	1x waterproof USB Type C (USB 3.2 Gen1 and 1x DisplayPort, supporting 3840x2160 at 60Hz)		Environmental		
Serial Port + DO	1x isolated RS-485, 1x RS-232, and 1x isolated DO via M12 A-coded 8-pin connector		Operating Temperature	-25°C to 70°C (30W TDP mode, without 10GbE transmission and PoE Load) ** -25°C to 60°C (30W TDP mode, with full function)	
CAN Bus + DI	2x isolated CAN 2.0, and 1x isolated DI (GPS PPS input) via M12 A-coded 8-pin connector		Storage Temperature	-40°C to 85°C	
System Monitoring	1x isolated CAN 2.0 port and 1x isolated DO via M12 A-coded 8-pin connector by automotive-grade MCU		Humidity	10% to 90%, non-condensing	
Internal I/O Interface			Vibration	MIL-STD-810H, Method 514.8, Category 4	
Mini PCI Express	1x full-size mini PCI Express socket (PCIe + USB 2.0) for WiFi 6 or CAN 1x full-size mini PCI Express socket (USB 2.0) for GNSS or 4G LTE		Shock	MIL-STD-810H, Method 516.8, Procedure I	
M.2	1x M.2 3042/ 3052 B key (USB 3.1 Gen 1 + USB 2.0) for LTE/ 5G module with dual micro SIM support		EMC	CE/ FCC Class A, according to EN 55032 & EN 55035 EN 50121-3 (EN 50155:2017, Clause 13.4.8)	

* The maximum current of each pin is 16A.

** For sub-zero and over 60°C operating temperature, a wide temperature HDD or Solid State Disk (SSD) is required.

Appearance

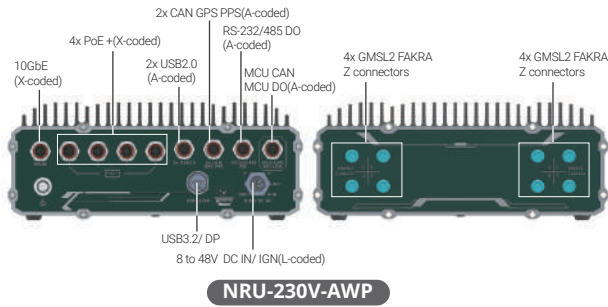

NRU-230V-AWP

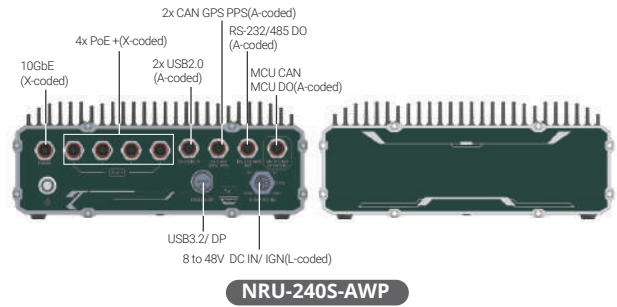

NRU-240S-AWP

Dimensions

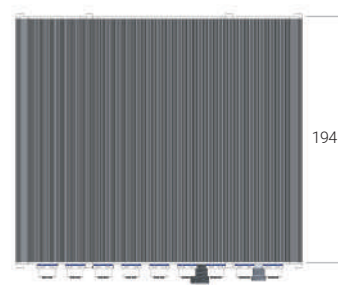
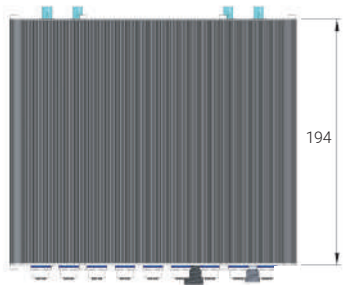

Unit : mm

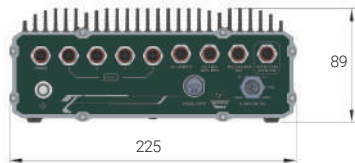

NRU-230V-AWP

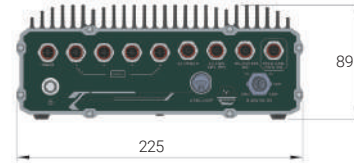

NRU-240S-AWP





Ordering Information

Model No.	Product Description
NRU-230V-AWP-JAO32	IP66 Waterproof Jetson AGX Orin™ (32GB) Computer with 8x GMSL, 4x PoE+ GbE ports
NRU-230V-AWP-JAO64	IP66 Waterproof Jetson AGX Orin™ (64GB) Computer with 8x GMSL, 4x PoE+ GbE ports
NRU-240S-AWP-JAO32	IP66 Waterproof Jetson AGX Orin™ (32GB) Computer with 4x PoE+ GbE ports
NRU-240S-AWP-JAO64	IP66 Waterproof Jetson AGX Orin™ (64GB) Computer with 4x PoE+ GbE ports

Optional Accessories

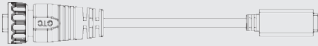
PA-160W-OW	160W AC-DC power adapter 20V/8A; 18AWG/120cm; cord end terminals for terminal block, operating temperature: -30 to 70°C.
PA-280W-ET2	280W AC/DC power adapter 24V/11.67A; 16AWG/100cm; cord end terminals for terminal block, operating temperature : -30°C to 60°C.
AC-IMX390-H60	Sony IMX390 CMOS sensor camera; 1920x1080 @30fps; LFM; HFOV 63.9°; IP67+IP69K; -40°C to 85°C operating temperature; male FAKRA connector; active alignment; without lens cap
AC-IMX390-H120	Sony IMX390 CMOS sensor camera; 1920x1080 @30fps; LFM; HFOV 120.6°; IP67+IP69K; -40°C to 85°C operating temperature; male FAKRA connector; active alignment; without lens cap
AC-IMX390-H190	Sony IMX390 CMOS sensor camera; 1920x1080 @30fps; LFM; HFOV 186°; IP67+IP69K; -40°C to 85°C operating temperature; male FAKRA connector; active alignment; without lens cap
AC-ISX031-H60	Sony ISX031 CMOS sensor w/ built-in ISP; 1920x1536 @30fps, HFOV H63.9°; IP67+IP69K; -40°C to 85°C operating temperature; male FAKRA connector; active alignment; without lens cap
AC-ISX031-H120	Sony ISX031 CMOS sensor w/ built-in ISP; 1920x1536 @30fps, HFOV H120.6°; IP67+IP69K; -40°C to 85°C operating temperature; male FAKRA connector; active alignment; without lens cap
AC-ISX031-H190	Sony ISX031 CMOS sensor w/ built-in ISP; 1920x1536 @30fps, HFOV H195.9°; IP67+IP69K; -40°C to 85°C operating temperature; male FAKRA connector; active alignment; without lens cap
AC-IMX490-H30	Sony IMX490 CMOS sensor camera; 2880x1860 @30fps; LFM; HFOV 30.0°; IP67+IP69K; -40°C to 85°C operating temperature; male FAKRA connector; active alignment; without lens cap
AC-IMX490-H60	Sony IMX490 CMOS sensor camera; 2880x1860 @30fps; LFM; HFOV 62.5°; IP67+IP69K; -40°C to 85°C operating temperature; male FAKRA connector; active alignment; without lens cap
AC-IMX490-H120	Sony IMX490 CMOS sensor camera; 2880x1860 @30fps; LFM; HFOV 120°; IP67+IP69K; -40°C to 85°C operating temperature; male FAKRA connector; active alignment; without lens cap

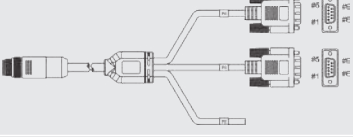
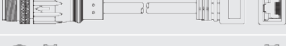
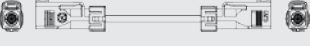
NRU-230S-AWP/NRU-240V- AWP

Type	Model Name	Description
	Cbl-TpCPlug-UTpCF-50CM	Waterproof TypeC Male Plug to USB Type-C FML Cable, Length: 50cm
	Cbl-M12A8M-2U2TA-180CM1	Waterproof M12 (8-pole-A-coded) to 2x USB 2.0 type A (female), Length: 180CM
	Cbl-M12A8M-2DB9M_OW2-180CM1	Cable 180cm, Waterproof M12 A-Code Male 8P to x2 DB9 Male+2P
	Cbl-M12X8M-RJ45F-100CM	Waterproof M12 (8-pole-X-coded) to RJ45 Female, CAT6A, Length: 100CM
	Cbl-FAKRA-ZFM-ZFM-12M	Waterproof FAKRA Z-code Female to Waterproof FAKRA Z-code Female, Length: 12M
	FK-FF-CABLE-7M	FAKRA SMB ST. Female Z code to FAKRA SMB ST. Female A code, Length: 700CM

Cable Kit

NRU-230V-AWP or NRU-240S-AWP front panel cable kit

Cblkit-FP-NRU-230V-AWP_NRU-240S-AWP	1x Cbl-TpCPlug-UTpCF-50CM	1x Cbl-M12A8M-2U2TA-180CM1
	3x Cbl-M12A8M-2DB9M_OW2-180CM1	5x Cbl-M12X8M-RJ45F-100CM

NRU-230V-AWP back panel cable kit

Cblkit-BP-NRU-230V-AWP	8x Cbl-FAKRA-ZFM-ZFM-12M
-------------------------------	--------------------------