

EXAIR®

MANUFACTURING INTELLIGENT COMPRESSED AIR® PRODUCTS SINCE 1983



COAT



COOL



CONSERVE



CLEAN



CONVEY

34 CATALOG

NEW

HollowStream™ Liquid Atomizing Cone Nozzles..... pg. 103

TurboBlast® Safety Air Guns..... pg. 115

Intellistat® Ion Air Nozzle..... pg. 143



YOU REQUESTED THIS CATALOG AND PRICE LIST.
PLEASE SEE MAILING LABEL ON BACK COVER.



THANKS FOR CHOOSING...

...EXAIR as the source for your problem solving products. This catalog includes new products, technical data, photos and drawings to help you with your application. Please take a few extra minutes to review the different sections of this catalog. Chances are, you'll find the answers to some of your industrial/production problems.

EXAIR products are designed to improve the overall efficiency of your operations. Our Ultrasonic Leak Detector, the EFC™ Electronic Flow Control for compressed air and Digital Flowmeter are money-saving and energy-conserving tools that can save your company tens of thousands of dollars. The Digital Sound Level Meter can help you increase safety and eliminate costly fines resulting from high noise.

The Best Practices for Compressed Air Systems manual published by the Compressed Air Challenge® recommends Intelligent Compressed Air® products like the Super Air Knife™, Super Air Amplifier™, and the family of Super Air Nozzles™ for energy conservation. Our Intelligent Compressed Air® products are identified with this graphic.



The people at EXAIR do their best to earn your business. When you contact EXAIR, you can expect quality products along with exceptional value and service since the products we manufacture are sold direct to you.

Here are a few ways we make that happen:

Free Expert Technical Help! Our full staff of qualified Application Engineers is here to help you with your application. When you call our toll free number, live chat, tweet, fax or e-mail us, you'll get help right away from someone who understands the product and your application.

Great support! Would you like to read our blog posts regarding new applications, to use energy cost calculators to see how much your company can save, or to receive Twitter alerts for up to the minute information? Do you need a CAD drawing of an EXAIR product, a copy of a lost installation sheet or want to place an order after hours? Our secure web site lets you do all that and more!

Special Products Just For You! Do you have an application for a product that isn't shown in our catalog? Need an EXAIR product in another size, an odd length or different material? We manufacture many specials as shown throughout this catalog. Just let us know what you have in mind.

Fast Delivery! The products shown in this catalog are in stock and in most cases, will ship the same day you order.

For 25 years running, 99.9% of our orders shipped on time!

We will continue to do everything possible to see that you are satisfied with EXAIR. We appreciate your interest in our products and look forward to working with you.

Sincerely,

Bryan Peters, President

P.S. There's no risk to try our products. In addition to our five year warranty, we extend the following Unconditional Guarantee to all our U.S. and Canadian customers:



EXAIR unconditionally guarantees its cataloged products for 30 days.

If you are not satisfied for any reason within that time, you may return the product for full credit with no restocking charge.



Compressed Air Challenge is a registered trademark of Compressed Air Challenge, Inc.

EXAIR is the leader in standards compliance



Stay up to date by visiting our website and take advantage of the information and services we didn't have room to display in this catalog.

EXAIR.com[®]

The digital home of Intelligent Compressed Air[®] products for industry



Where you can

- **Chat live** with our problem solving, technical expert Application Engineers
- **Watch product videos** to learn more about the features and benefits of our engineered products
- Quickly **order online** with a purchase order or credit card (US & Canada)
- **Access product presentation slides** you can use to educate others
- **Find International Distributors** all across the world



Access our Knowledge Base to

- **Download 3D models** and CAD drawings in multiple formats to place into your drawings
- **Calculate air savings and ROI** to see how quickly EXAIR products will pay off
- Search our **Case Study Library & Applications database** and become familiar with how our products solve problems
- **Use our product FAQ's** for quick access to our most common questions
- Learn about our free **Efficiency Lab** service and use it to **determine air and money savings** you can achieve when installing EXAIR engineered solutions
- Collect compressed air data and pipe sizing recommendations
- **Find** Flow, Force and Heat conversions



Visit our PDF library and download

- Electronic files of the **entire catalog** or individual sections
- **Installation and Maintenance Guides** on every EXAIR product
- Our current **price list** to have all product prices in one convenient location
- EXAIR's **Air Nozzle Blowoff Guide** to see the details on our enormous selection of sizes, materials and performance options



Follow our blog for 5 new entries a week and learn

- Details and installations of widely varied applications
- The methodology and results of critical mathematical formulas which help determine money savings, air savings, performance benefits and more
- New product releases before they reach our catalog or website
- More about EXAIR, our team and community involvement
- **Go to** blog.exair.com



Make social connections

- Watch **over 90 videos** on EXAIR's YouTube Channel and see product features and benefits, applications, Tips & Tricks, How-to, our team members, or be entertained by Professor Penurious!
- **Follow our Company on Twitter @EXAIR** or our Application Engineers and learn more about promotions, updates on manufacturing, engineering and international industry perspective.



@EXAIR_BF



@EXAIR_BW



@EXAIR_EK



@EXAIR_JB



@EXAIR_JS



@EXAIR_NR



@EXAIR_RB



@EXAIR_TD

- **Connect with us on Facebook** at facebook.com/exair or follow us on Instagram.

Not on a PC? Our website is mobile friendly



6 EXAIR Optimization

Minimize compressed air use and detect wasteful leaks

6 Steps to Optimization.....	6
Electronic Flow Control.....	7
Digital Flowmeter.....	10
Digital Flowmeter with wireless capability.....	11
Digital Sound Level Meter.....	17
Ultrasonic Leak Detector.....	18



20 Air Knives

Blowoff, clean, dry and cool with less noise and air consumption

Super Air Knife.....	20
Compare Blowoffs.....	23
Explanation of Materials.....	26
Universal Air Knife Mounting System.....	29
Plumbing Kits.....	29
Standard Air Knife.....	33
Full-Flow Air Knife.....	36



38 Air Wipes

Blowoff, dry, clean and cool pipe, cable, extruded shapes and hose

Super Air Wipes.....	38
Standard Air Wipes.....	42



44 Air Amplifiers

Vent, exhaust, cool, dry and clean - with no moving parts

Super Air Amplifiers.....	46
Adjustable Air Amplifiers.....	50



52 Air Nozzles and Jets

Reduce noise levels and air costs on blowoff operations

Air Nozzles.....	52
Air Nozzle Comparison Chart.....	54
Super Air Nozzles.....	55
Flat Super Air Nozzles.....	57
Super Air Scraper.....	57
Back Blow Air Nozzles.....	59
Safety Air Nozzles.....	60
Air Jets.....	61
High Force Air Nozzles.....	63
High Force Air Nozzle Comparison Chart.....	63
High Force Flat Super Air Nozzles.....	63
High Force Super Air Nozzles.....	64
Super Air Nozzle Clusters.....	67
Stay Set Hoses.....	67
Swivel Fittings.....	68
Blowoff Systems.....	69



70 Air Atomizing Nozzles

All stainless steel construction for durability and corrosion resistance

1/8 NPT Atomizing Nozzles.....	71
Internal Mix Narrow Angle Round.....	71
Internal Mix Wide Angle Round.....	72
Internal Mix Flat Fan.....	73
External Mix Narrow Angle Flat Fan.....	74
Siphon Fed Round.....	75
Siphon Fed Flat Fan.....	76
1/4 NPT Atomizing Nozzles.....	77
Internal Mix Narrow Angle Round.....	77
Internal Mix Wide Angle Round.....	78
Internal Mix Flat Fan.....	79
Internal Mix Deflected Flat Fan.....	80
Internal Mix 360° Hollow Circular.....	80
External Mix Round.....	81
External Mix Narrow Angle Flat Fan.....	82
External Mix Wide Angle Flat Fan.....	83
Siphon Fed Round.....	84
Siphon Fed Flat Fan.....	85
1/2 NPT Atomizing Nozzles.....	86
Internal Mix Narrow Angle Round.....	86
Internal Mix Wide Angle Round.....	87
Internal Mix Flat Fan.....	88
Internal Mix 360° Hollow Circular.....	89
External Mix Narrow Angle Flat Fan.....	90
Siphon Fed Round.....	91



92 No Drip Air Atomizing Nozzles

Eliminate drips to conserve valuable liquids and improve product finishes.

1/8 NPT No Drip Atomizing Nozzles.....	93
No Drip Internal Mix Narrow Angle Round.....	93
No Drip Internal Mix Wide Angle Round.....	93
No Drip Internal Mix Flat Fan.....	94
No Drip External Mix Narrow Angle Flat Fan.....	95
No Drip Siphon Fed Round.....	96
No Drip Siphon Fed Flat Fan.....	96
1/4 NPT No Drip Atomizing Nozzles.....	93
No Drip Internal Mix Narrow Angle Round.....	93
No Drip Internal Mix Wide Angle Round.....	93
No Drip Internal Mix Flat Fan.....	94
No Drip Internal Mix Deflected Flat Fan.....	94
No Drip Internal Mix 360° Hollow Circular.....	94
No Drip External Mix Round.....	95
No Drip External Mix Narrow Angle Flat Fan.....	95
No Drip External Mix Wide Angle Flat Fan.....	95
No Drip Siphon Fed Round.....	96
No Drip Siphon Fed Flat Fan.....	96
1/2 NPT No Drip Atomizing Nozzles.....	93
No Drip Internal Mix Narrow Angle Round.....	93
No Drip Internal Mix Wide Angle Round.....	93
No Drip Internal Mix Flat Fan.....	94
No Drip Internal Mix 360° Hollow Circular.....	94
No Drip External Mix Narrow Angle Flat Fan.....	95
No Drip Siphon Fed Round.....	96
Droplet Size/Spray Angle Information.....	97



98 Liquid Atomizing Spray Nozzles

Stainless-steel nozzles to atomize pressured liquids. No air required.

FullStream Cone Nozzles.....	99
HollowStream Cone Nozzles.....	102

104



Safety Air Guns

Safety air guns use engineered air nozzles for high performance

Chip Shields.....	105
VariBlast® Precision Safety Air Guns.....	106
VariBlast® Compact Safety Air Guns.....	107
Soft Grip Safety Air Guns.....	109
Soft Grip Super Air Scraper.....	112
Heavy Duty Safety Air Guns.....	113
Back Blow Safety Air Guns.....	114
NEW TurboBlast® Safety Air Guns.....	115
Super Blast Safety Air Guns.....	117

119



Gen4® Static Eliminator

Eliminate static electricity, dust and shock hazard

Gen4® Super Ion Air Knife.....	121
Static Meter.....	123
Gen4® Standard Ion Air Knife.....	127
Gen4® Ionizing Bars.....	129
Gen4® Super Ion Air Wipes.....	131
Gen4® Ion Air Cannon.....	133
Gen4® Ion Air Gun.....	135
Gen4® Ion Air Jet/Gen4 Stay Set Ion Air Jet.....	137
Gen4® Ionizing Point.....	139
Gen4® Power Supplies.....	140
Intellistat® Ion Air Gun.....	141
NEW Intellistat® Ion Air Nozzle.....	143

145



E-Vac® Vacuum Generators

Vacuums for lifting, clamping, mounting and placement

How to Build an E-Vac System.....	146
In-Line.....	147
Adjustable.....	150
Vacuum Cups.....	152

156



Air Operated Conveyors

Convey parts, materials and waste - with no moving parts

Line Vac.....	156
Threaded Line Vac.....	162
Heavy Duty Line Vac.....	165
Sanitary Flange Line Vac.....	167
Light Duty Line Vac.....	169

171



Industrial Housekeeping

Reliable vacuums for chip removal, liquid transfer and cleaning

EasySwitch® Wet-Dry Vac.....	171
Reversible Drum Vac.....	173
High Lift Reversible Drum Vac.....	175
Chip Trapper.....	177
High Lift Chip Trapper.....	179
Chip Vac.....	181
Heavy Duty Dry Vac.....	183
Heavy Duty HEPA Vac.....	185
Vac-u-Gun.....	187

189



Vortex Tubes & Spot Cooling

Cold air for industrial spot cooling problems

Vortex Tubes.....	189
Adjustable Spot Cooler.....	197
Mini Cooler.....	200

201



Cold Gun Aircoolant Systems

Cool machining operations with clean, cold air

205



Cabinet Cooler® Systems

Cool and purge NEMA 12, 4 and 4X electrical control panels

How it Works.....	206
Selecting the Right Model.....	206
Special Cabinet Coolers.....	207
Calculating Heat Load.....	209
Cabinet Cooler Sizing Guide.....	210
NEMA 12 Models.....	212
NEMA 4 Models.....	213
NEMA 4X Models.....	214
Cabinet Cooler System Accessories.....	215
Hazardous Location Cabinet Coolers.....	216

218



Accessories

Mufflers, filters, regulators, valves, swivel fittings and more

Filters.....	218
Regulators.....	219
Silencing Mufflers.....	220
Valves, Swivels, Thermostats.....	222
Magnetic Bases, Stay Sets, Hoses.....	223
Air Hoses.....	223
Fittings.....	224
Receiver Tank.....	224

ORDER BY
2 PM
SHIPS SAME DAY

Catalog item orders received before 2 pm EDT/EST are generally shipped from Cincinnati, Ohio on the same day. You can expect delivery within 1-4 days depending on your location.

Terms and Conditions (U.S. and Canada Only)

Terms: Net 30 days upon credit approval, Visa, MasterCard, Discover and American Express.



Cards

ICC (International Chamber of Commerce)
INCOTERM 2010:

Delivery

EX WORKS (EXAIR Corporation, 11510 Goldcoast Dr., Cincinnati, Ohio 45249, USA)

All cataloged products are shipped from stock, via U.P.S. within 24 hours after receipt of order. Priority shipment is available upon request.

Ordering:

Call 1-800-903-9247 or +1-513-671-3322 Worldwide 7:00 a.m. to 4:00 p.m. ET (Mon. - Fri.)

Fax toll free 1-866-329-3924 or

Worldwide +1-513-671-336

E-mail: orders@exair.com

Secure website: www.exair.com

Remit to address (payments only):

EXAIR Corporation Location 00766, Cincinnati, Ohio 45264-0766

Tax:

Sales and use tax, where applicable, are not included.

Technical Assistance:

Please call our Application Engineering Department,
1-800-90-EXAIR (1-800-903-9247) e-mail at techelp@exair.com.



Warranty:

*5 Year Warranty applies to compressed air products only.
A 1 Year Warranty applies to all accessories and electrically powered products.

5 Year "Built To Last" Warranty against defects in workmanship and materials on all compressed air products*. Defective products must be returned freight prepaid for repair or replacement at our option. This warranty applies under conditions of normal use, but does not apply to defects that result from intentional damage, negligence, unreasonable use, wear or exposure.

EXAIR's Unconditional Guarantee:

Extends to all U.S. and Canadian customers and includes invoiced U.P.S. Ground Service shipping charges. Products returned after the 30 day guarantee period are subject to a 15% restocking charge. Products must be returned freight prepaid.



Copyright Restrictions:

The content of the EXAIR Catalog, including all photos, graphics, drawings and arrangements are proprietary to EXAIR Corporation and are protected by the United States and international copyright and trademark laws. You are authorized to use the contents of the EXAIR Catalog for personal use or as it relates to your role as a current or prospective customer of EXAIR. The contents of this catalog may not be copied or modified for any type of publication or distribution without the prior written consent of EXAIR Corporation. The content of the EXAIR Catalog is the intellectual property solely of the EXAIR Corporation with no rights transferred to other parties. No part of this catalog may be reproduced for any commercial purposes without the express authorization in writing by the EXAIR Corporation.

Trademarks:

"EXAIR.com", "EXAIR", "Cabinet Cooler", "E-Vac", "Intelligent Compressed Air", "VariBlast", "Gen4", "Intellistar", "EasySwitch", "TurboBlast" and "Compressed Air Intelligence" are registered trademarks of the EXAIR Corporation. The EXAIR logo, product names, designs and descriptive phrases are trademarked by EXAIR Corporation. These trademarks may not be used without prior written permission of the EXAIR Corporation.

EXAIRLogger, EPC, Digital Flowmeter, Digital Sound Level Meter, High Power Cold Gun, Super Air Knife, Standard Air Knife, Full-Flow Air Knife, Air Cannon, Super Air Amplifier, Adjustable Air Amplifier, Super Air Nozzle, Micro Air Nozzle, High Power Safety Air Nozzle, Stay Set Hose, Soft Grip Super Air Scraper, Super Air Scraper, Super Blast Safety Air Gun, Super Air Wipe, Heavy Duty Line Vac, Light Duty Line Vac, Sanitary Flange Line Vac, Threaded Line Vac, FullStream, FloodStream, HollowStream, Standard Air Wipe, Super Ion Air Knife, Standard Ion Air Knife, Super Ion Air Wipe, Ion Air Cannon, Ion Air Gun, Ion Air Jet, Ionizing Point, Stay Set Ion Air Jet, Line Vac, Chip Vac, Heavy Duty Dry Vac, Heavy Duty HEPA Vac, Reversible Drum Vac, High Lift Reversible Drum Vac, Chip Trapper, High Lift Chip Trapper, Vac-u-Gun, Deep Hole Vac-u-Gun, Air Disk, Air Stik, Mini Cooler, Cold Gun Aircoolant System, and ETC are trademarks of EXAIR Corporation.

11510 Goldcoast Dr.
Cincinnati, Ohio 45249-1621
Phone Number: (513) 671-3322
Fax Number: (513) 671-3363
E-mail: techelp@exair.com
Web Site: www.exair.com



Intelligent Compressed Air® products are identified throughout this catalog that can help your plant save tens of thousands of dollars over the course of a single year. *The Best Practice for Compressed Air Systems* manual published by the Compressed Air Challenge® recommends products like the Super Air Knife®, Super Air Amplifier®, and the family of Super Air Nozzles® for energy conservation. Many of the products shown offer unique ways to solve common industrial problems using compressed air. Compressed Air Challenge is a registered trademark of Compressed Air Challenge, Inc.



EXAIR has partnered with Energy Star, a voluntary program of the U.S. Department of Energy and the Environmental Protection Agency. Energy Star offers energy efficient solutions to help save money while protecting the environment for future generations. EXAIR has implemented improved energy management practices and technologies throughout our facility, including energy efficient lighting, HVAC systems, and electronic thermostats. EXAIR's participation in this program underscores our commitment to conserving energy.

EXAIR products are subject to ongoing development. Specifications are subject to change without notice.

Some products in this catalog are covered by U.S. Patent #5402938, #8153001, #8268179, #D903,817 and #9156045, and others may be U.S. Patent Pending.

EU Regd. Des. No.00770318-0001 ☐ Mexico No.60723; Canada No.194141

Copyright ©2022 EXAIR Corporation. All Rights Reserved.



EXAIR®

EFFICIENCYLAB



EXAIR's Intelligent Compressed Air® products vs Your current installation

How does the Efficiency Lab work?

Our Efficiency Lab service begins with receiving a sample of the product(s) you currently use for your application. One of our qualified Application Engineers will use calibrated testing equipment to compare the performance of your existing product(s) to an EXAIR engineered solution. These tests will determine air consumption, noise levels and force. The test results will then be published in a comprehensive report, which includes a cost savings analysis, and be provided to you. For most applications, EXAIR products can help you improve application efficiency AND typically pay for themselves in a matter of weeks.

How can I get a product tested for free?

To participate in our FREE Efficiency Lab please contact one of our Application Engineers and get the details about sending us your product(s).

You may reach an Application Engineer by phone at (800) 903-9247 or (513) 671-3322. You can send an email to lab@exair.com or visit our website and take advantage of our live help at www.exair.com.

EXAIR's FREE Efficiency Lab service determines how much air and dollar savings you will achieve by installing one of our Intelligent Compressed Air products.

Unable to send your product to EXAIR's Efficiency Lab?

If it is not possible to send us your product, we have a one page Product Efficiency Survey on our website (exair.com/labdoc) where you can provide us the details about a current inefficient compressed air application. Fill in the information and click submit. You will hear from one of our Application Engineers within three business days.

Okay, so what is the fine print?

This service is available to all customers in the U.S. and Canada only. Some restrictions may apply.

What about confidentiality?

Yes, EXAIR will keep the results of our Efficiency Lab test and report confidential unless given permission to share that information with others.

Products must be shipped to EXAIR freight prepaid. EXAIR will pay the return shipping via UPS ground.

Static Eliminators

Eliminate static and dust!

Neutralize and clean at distances up to 20 feet!



What Is Static?

Material such as paper, plastic or textiles normally contain an equal number of positive and negative charges – that is, they are electrically balanced. Friction can disturb this balance, causing the material to become electrically charged.



The electrical charge (static) will exert a force on nearby charged objects or a grounded conductor. Among the problems caused by this force are:

- Dust clinging to product
- Product clinging to itself, rollers, machine beds or frames
- Materials tearing, jamming or curling
- Sheet feeding problems
- Hazardous sparks or shocks

Why Choose Static Eliminators and GEN4 Static Eliminators system?

EXAIR offers systems for total static control. When static is a problem on moving webs, sheet stock, three dimensional parts, extrusions or packaging, EXAIR has a solution. Our Gen4 static eliminators have undergone independent laboratory tests to certify it meets the rigorous safety, health and environmental standards of the USA, European Union and Canada that are required to attain the CE and UL marks. They are also RoHS compliant. Every Gen4 static eliminator offers:

- An armored high voltage cable to protect against abrasion, cuts, splits and other damage from the environment.
- Single wire, integrated ground design which eliminates the need for a separate ground connection
- Electromagnetic shielding in all cables to protect sensitive electronics
- Selectable Voltage (115V or 230VAC) power supplies with rugged stainless steel connections and integrated fuse protection on the primary input voltage. Available in 2 or 4 outlet versions.

Charged conductors (like metals) discharge completely when grounded. Insulators (like plastics) don't conduct electricity and can't discharge when grounded. Grounded brushes or tinsel often have little effect on these surfaces.

When aiming EXAIR's Model 7905 Static Meter at a single plastic surface, it is common to measure many voltages across the same surface. The higher the voltage measured, the stronger the static charge or force at that point. It is also possible for some voltages to have opposite polarities (positive or negative) which determines if two insulators will attract or repel one another.

EXAIR's Gen4 static eliminators (also called ionizers) can eliminate the charge. These shockless ionizers are electrically powered and produce a bulk of positive and negative ions. The charged surface attracts the appropriate number of positive or negative ions from the ionizer to become neutral (discharged).



A small Model 112203 3" (76mm) Gen4 Super Ion Air Knife System eliminates contaminants from syringes prior to packaging.

Static Eliminators

GEN4® Static Eliminators

GEN4 Static Eliminators With Air

Combining our engineered airflow products with ionizers gives us the ability to eliminate a static charge quickly and from great distances. Laminar flow airstreams make it possible to blow away any contaminants and eliminate the charge that attracts them. They are ideal for:

- Hard to reach places or obstructed surfaces
- Product moving at high speeds
- Surfaces with an extremely high charge

Compressed air consumption and noise are minimized while providing force that can be adjusted from a “blast” to a “breeze”. Tests show these ionizers positioned two feet (610mm) away from a charged surface to be as effective as a Gen4 Ionizing Bar without air delivery positioned one-half inch (13mm) from the surface.

The **Gen4 Super Ion Air Knife** provides 34% better static elimination than previous Super Ion Air Knife models and the best performance of all EXAIR ionizers. It uses our Super Air Knife (40:1 air amplification) to deliver a uniform sheet of ionized air effective up to 20 feet (6.1m) away.

The **Gen4 Standard Ion Air Knife** performance is improved by 30% over previous Standard Ion Air Knives. It delivers a sheet of ionized air to the surface with 30:1 air amplification ratio that is less efficient than the Gen4 Super Ion Air Knife.

The **Gen4 Super Ion Air Wipe** clamps around the part and creates a ring of ionized airflow. It neutralizes and cleans continuous moving surfaces.

The **Gen4 Ion Air Cannon** uses our Super Air Amplifier (22:1 air amplification) to provide a focused, conical airstream that is capable of removing the charge up to 15 feet (4.6m) away.

The **Gen4 Ion Air Gun** uses our High Velocity Air Jet (5:1 air amplification) to provide a narrow beam of ionized airflow. This hand-held static eliminator is rugged for industrial use and has incredibly fast static decay rates.

The **Gen4 Ion Air Jet** uses our High Velocity Air Jet (5:1 air amplification), and is an effective spot cleaner. Available for permanent mount or with flexible Stay Set Hose, this ionizer is the ideal way to focus an ionized airflow at confined areas.

GEN4 Static Eliminators Without Air

In some situations, even the smallest amount of airflow can disturb the product. This is especially true for lightweight materials. EXAIR manufactures two styles of ionizers for these critical applications.

Gen4 Ionizing Bars perform 25% better than previous Ionizing Bars and are ideal for relatively flat materials, where the bar can be mounted within 4" of the product surface.

The **Gen4 Ionizing Point** is effective for spot neutralization. The compact size makes it ideal for winding or slitting operations. It can also be mounted through a duct to neutralize static charges due to moving air or materials.

Special Static Eliminators

EXAIR manufactures static eliminators suited to specific application requirements. This special ionizer (shown bottom right) was developed for the automotive industry. This air amplifier and ionizer combination is used to dry water based paints on car bodies while eliminating the possibility of a static charge that might attract dust or other contaminants.

If you have special requirements, please contact an Application Engineer to discuss the application.



A Model 8006 6" (152mm) Gen4 Ionizing Bar eliminates the static charge causing packing peanuts to cling.

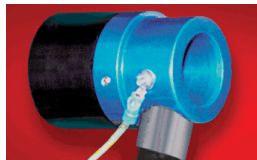

This special ionizer dries water based paint on car bodies and eliminates any static problems.



GET4[®] Super Ion Air Knife™

Powerful static eliminator prevents jamming, tearing, shocks and dust up to 20' away!

Uses The Super Air Knife

- Low Air Consumption!
- Surprisingly Quiet!
- Uniform Airflow!
- End and Bottom Air Inlets!

What Is The GET4 Super Ion Air Knife?

EXAIR's Gen4 Super Ion Air Knife offers 34% improved performance at low pressures allowing you to achieve the same or better results, which saves compressed air and money. Gen4 Super Ion Knives remove static electricity from plastics, webs, sheet stock and other product surfaces where tearing, jamming or hazardous shocks are a problem. The laminar sheet of air sweeps surfaces clean of static, particulate, dust and dirt. Production speeds, product quality, and surface cleanliness can improve dramatically.

Why The GET4 Super Ion Air Knife?

The Gen4 Super Ion Air Knife floods an area or surface with static eliminating ions - up to 20 feet (6.1m) away. A uniform airflow across its length will not cause misalignments to critical surfaces such as webs. Force can be adjusted from a "blast" to a "breeze". The Gen4 Super Ion Air Knife is electrically powered, is shockless and has no moving parts. **It also requires only 3.7 SCFM of compressed air per foot of length at 5 PSIG (105 SLPM per 300mm of length at 0.3 BAR).** Sound level is surprisingly quiet at 50 dBA for most applications

Applications

- Web cleaning
- Molding machinery
- Sheeters and trimmers
- Cleaning parts
- Pre-paint dust removal
- Shrink wrappers
- Package cleaning
- Bag opening/ fill operations
- Printing equipment

Advantages

- Up to 34% improved performance
- Rugged metal armored and electromagnetically shielded cable
- Integrated ground eliminates additional ground connection
- Durable stainless steel connections to Power Supply
- Low air consumption
- Uniform airflow across entire length
- Quiet
- Effective up to 20 feet (6.1m)
- Shockless, non-radioactive
- Compact, rugged, easy to install
- Unlimited system lengths of uninterrupted airflow
- Low maintenance
- UR/CE
- EMC Compliant
- Modular power supply cable eases connections and routing



The Gen4 Super Ion Air Knife eliminates the static charge on labels being applied to PET soft drink bottles.



The Model 112118 18" (457mm) Gen4 Super Ion Air Knife System eliminates dust from body care products prior to sealing the boxes in cellophane.



Bumpers, car bodies and fascia are cleaned of dust and fibers prior to painting.

Static Eliminators

GEN4[®] Super Ion Air Knife

How The GEN4 Super Ion Air Knife Works

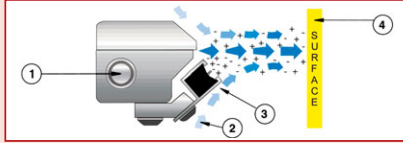

Compressed air flows through an inlet (1) into the plenum chamber of the Gen4 Super Ion Air Knife. The flow is directed to a precise, slotted orifice. As the primary airflow exits, it creates a uniform sheet of air across the entire length that immediately pulls in surrounding room air (2). An electrically powered Gen4 Ionizing Bar (3) fills the curtain of air with positive and negative charges. The airstream delivers these static eliminating ions to the product surface (4) where it instantly neutralizes static and cleans off dust and other particulates.

Added Features

- Compressed air inlets are provided on each end and the bottom of the Gen4 Super Ion Air Knife. Unlimited lengths available up to 118" (3m).
- Thicker shims can be installed easily if additional hard-hitting velocity is required.
- Primary air does not impact any surface of the Gen4 Super Ion Air Knife which keeps the sound level low.
- Insertion molded emitter points eliminate potential dirt accumulation that could degrade performance or eventually short the ionizing bar.
- Emitter points are sharp, durable stainless steel.
- The high voltage cable is armored to resist cuts and abrasion and has integral grounding, which prevents an additional connection. The threaded bayonet connector is fully assembled and ready to use.
- Electromagnetically shielded cable protect sensitive electronics.
- Gen4 Super Ion Air Knife Kits, which include all components necessary for operation, are available.

GEN4 Super Ion Air Knife Performance

Pressure Supply	Air Consumption*	Sound Level	Dissipates 5kV**		
PSIG	BAR	SCFM	SLPM	dBA	SECONDS
5	0.3	3.7	105	39	0.40
10	0.7	5.5	156	51	0.33
20	1.4	13.2	372	57	0.26
40	2.8	20.4	576	61	0.23
60	4.1	27.6	780	65	0.21
80	5.5	34.8	984	69	0.20
100	6.9	42.0	1,188	72	0.18

* per foot (305mm) of length

** 6" (152mm) from target

For airflow pattern, see Super Air Knife page 24

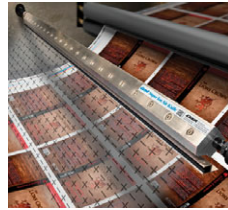

The Model 112048 48" (1219mm) Gen4 Super Ion Air Knife neutralizes the static electricity and cleans the surface of the paper.

GEN4 Super Ion Air Knife Dimensions

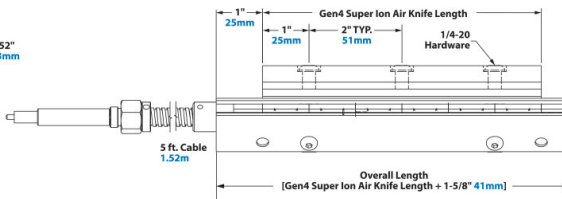
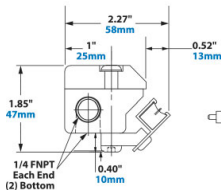

DOWNLOAD drawings at EXAIR.com

Enhanced Performance and Reliability

Gen4 Ionizing Bars are most effective with an air delivery system. That allows the static eliminating ions to reach farther with greater coverage. Gen4 Ionizing Bars are less effective without an air delivery system. When used by itself, a bar must be mounted within 4 inches of the charged surface to fully neutralize it. This close mounting is impossible when the static is generated in confined areas of a machine. Ion coverage is minimal on oddly configured parts or when high production speeds are involved.

The right type of air delivery is critical. Blowers produce an uneven, turbulent airstream that can cause the positive and negative ions to recombine before hitting the charged material. They are large, suffer mechanical wear and provide limited airflow control. The compact Gen4 Super Ion Air Knife uses a small amount of compressed air to produce a balanced, laminar sheet of air to carry the ions to the charged surface, even when it is far away. Flow and force are easily controlled and there are no moving parts to wear out.

GEN4 Super Ion Air Knife Specifications

The Gen4 Super Ion Air Knife is available in standard lengths of 3", 6", 9", 12", 18", 24", 30", 36", 42", 48", 54", 60", 72", 84", 96" and 108" (76, 152, 229, 305, 457, 610, 762, 914, 1067, 1219, 1372, 1524, 1829, 2134, 2438 and 2743mm). **Special lengths and unlimited system lengths are available (please contact our factory).**

A 5' (1.52m) armored and electromagnetically shielded power cable with ground and assembled bayonet connector are included.

EXAIR Model 7960 or 7961 Gen4 Power Supply (5kV) is required for Super Ion Air Knife operation.

Power supplies are equipped with a modular 6' (1.83m) power cord, lighted power switch integrated fuse on the primary and (2) or (4) high voltage outlets.

Certifications: Gen4 Ionizing Bars and Gen4 Power Supplies are UL Component Recognized to U.S. and Canadian safety standards, and are CE and RoHS compliant.

Compressed Air: 1/4 NPT inlets are provided on each end and the bottom.

Electrical: For use with Model 7960 or 7961 5 kVrms, 5 milliamperes (max.) power supply.

Electrical Hazard: Gen4 Ionizing Bars are shockless (less than 40 microamperes short circuited).

Do not use near flammable materials or gases.

Materials of Construction:

Metal Parts: Aluminum

Plastic Parts: UL rated 94 HB

Emitters: Stainless Steel

Maximum Ambient Temperature: 165°F (74°C)

Shims: Thicker shims can be installed easily if additional hard-hitting velocity is required. For more information, see "shim sets" on page 25.



Model 9060 Universal Air Knife Mounting System provides secure, precise positioning for the Gen4 Super Ion Air Knife. See page 29 for details.

Static Eliminators

Static Meter

Static Meter

Locate the source of the static problem!



Digital Static Meter Locates The Source!

The Model 7905 Digital Static Meter allows easy one-hand static measurements. In most cases, the highest voltage reading will indicate the source of the static problem. Sensitive and responsive, it indicates the surface voltage and polarity on objects up to ± 20 kV when measured one inch (25mm) away.

The Digital Static Meter features a push button "hold" for readings, a low battery indicator and an automatic "power off". A "zero" button to zero the instrument ensures an accuracy of $\pm 5\%$ of the reading when it is one inch (25mm) from the charged surface.



The Model 7905 Digital Static Meter comes complete with a hard-shell plastic case and a 9 volt battery. Certification of the accuracy and calibration traceable to NIST (National Institute of Standards and Technology) is also included. Calibration is available.

Gen4[®] Super Ion Air Knife

Dust Removal From Car Bodies

The Problem: Car bodies are primer coated, then sanded before entering the paint booth. Priming dust, attracted to the car body by a static charge, creates imperfections that are captured and magnified in the painting process.

The Solution: An “archway” of Model 112024 24” (610mm) Gen4 Super Ion Air Knives was installed upstream of the paint booth. As the car bodies pass through, a high velocity sheet of ionized air neutralizes the static charge to release the dust and blow it toward a collection system.

Comment: Non-turbulent airflow was the reason this cleaning system worked so well. The compact Gen4 Super Ion Air Knife has the ability to move the bulk of the static eliminating ions to the car surface. It can be adjusted from a gentle breeze of air to a pounding blast, with instant “on/off” capability. Uniform airflow across the entire length assures that all car body surfaces are neutralized and dust free. Best of all, the Gen4 Super Ion Air Knife is easy on the compressed air system and workers’ ears. They use much less compressed air than standard blowoffs and are around 69 dBA in most applications.

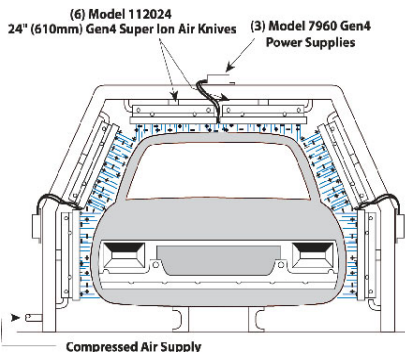

EXAIR's EFC (shown on page 7) is an electronic flow control for compressed air. It can sense when there is no car present and will automatically turn off the compressed air until the next car is moved into position. It is a perfect addition to this type of application.

A Manufacturer Of Perfumes And Fragrances Eliminates Dust From Their Packages

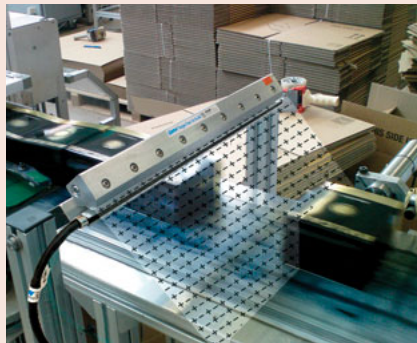

The Problem: A manufacturer of perfumes and fragrances had a problem with the packaging of their fine perfumes. The conveyor belt used to transport the boxes to the cellophane sealer rubbed against the box surface and induced a sizable static electricity charge on it that made it a "dust magnet". The cardboard dust and particulates

in their facility would land on the perfume boxes that were sent through the cellophane sealer. The trapped dust gave a poor appearance to the finished package. The company refused to let the boxes with the poor appearance leave their facility. Attempts to clean them using ordinary air guns produced poor results.

The Solution: The company installed a Model 112018 18" (457mm) Gen4 Super Ion Air Knife prior to the box entering the sealer. The charged surface was completely neutralized with the ionized airflow and the dust and particulates were blown away. The cellophane covered boxes were perfectly clean.

Comment: EXAIR's Gen4 Super Ion Air Knife is used for applications just like these where appearance is vital to the sale of the product. The Gen4 Super Ion Air Knife is commonly used for pre-package cleaning, bag opening and filling operations, cleaning automobile bodies prior to painting, web cleaning, as well as eliminating jams, tears and those painful static electricity shocks.

Cleaning Porcelain Dishes Prior To Glazing



The Problem: A manufacturer of fine porcelain dinnerware products had a problem with dust ruining the finish on their dishes. Dust particles were adhering to the surface of the dishes which created imperfections that were greatly magnified once the glaze was applied. Prior to glazing, they made attempts to blow the dust particles away using ordinary air nozzles which had little effect, if any. There were abundant rejects.

The Solution: They installed (3) **Model 112018 18" (457mm) Gen4 Super Ion Air Knives** to surround each dish, neutralize the static charge and remove the dust particles. Any airborne particulate was immediately vacuumed away by their dust collection system. The dishes were completely smooth to the touch with no imperfections.

Comment: A similar problem used to plague automotive manufacturers. The static charge generated by the automobile body tack off operation would cause the car body to attract stray particles of priming dust. Once the paint hits a dust particle, it sticks out like a sore thumb and ruins an otherwise perfect robotic paint job. The **Gen4 Super Ion Air Knife** is ideal here since it neutralizes the charge and blows the dust away (in the direction of their dust collection system). To minimize compressed air use for these applications, we recommend the use of an EXAIR EFC Electronic Flow Control that automatically turns off the compressed air when no part is present.

Gen4 Super Ion Air Knife Models

Gen4 Super Ion Air Knife - includes the Super Air Knife and Gen4 Ionizing Bar assembly.

Gen4 Super Ion Air Knife Systems - include a Gen4 Super Ion Air Knife and Model 7960 Gen4 Power Supply (115V, 230V, 50/60 Hz)

Gen4 Super Ion Air Knife Kits - include a Gen4 Super Ion Air Knife, Model 7960 Gen4 Power Supply, shim set, filter separator and pressure regulator (with coupler).

Gen4 Deluxe Super Ion Air Knife Kits - include a Gen4 Super Ion Air Knife, Model 7960 Gen4 Power Supply, EFC, Universal Mounting System, shim set, filter separator and pressure regulator (with coupler).

Length	Gen4 Super Ion Air Knife Model	Gen4 Super Ion Air Knife Systems Model	Gen4 Super Ion Air Knife Kits Model	Gen4 Deluxe Super Ion Air Knife Kits Model
3" (76mm)	112003	112103	112203	112203DX
6" (152mm)	112006	112106	112206	112206DX
9" (229mm)	112009	112109	112209	112209DX
12" (305mm)	112012	112112	112212	112212DX
18" (457mm)	112018	112118	112218	112218DX
24" (610mm)	112024	112124	112224	112224DX
30" (762mm)	112030	112130	112230	112230DX
36" (914mm)	112036	112136	112236	112236DX
42" (1067mm)	112042	112142	112242	112242DX
48" (1219mm)	112048	112148	112248	112248DX
54" (1372mm)	112054	112154	112254	112254DX
60" (1524mm)	112060	112160	112260	112260DX
72" (1829mm)	112072	112172	112272	112272DX
84" (2134mm)	112084	112184	112284	112284DX
96" (2438mm)	112096	112196	112296	112296DX
108" (2743mm)	112108	112108	1122108	1122108DX



Kits include the Gen4 Super Ion Air Knife, shim set, Model 7960 Gen4 Power Supply, filter separator and pressure regulator (with coupler).



Universal Air Knife Mounting System

EXAIR's Universal Air Knife Mounting System allows easy positioning of all EXAIR Air Knives. See page 29 for details.

GEN4[®] Super Ion Air Knife

GEN4 Long Super Ion Air Knives

EXAIR offers Long Gen4 Super Ion Air Knives in 60" (1524mm), 72" (1829mm), 84" (2134mm), 96" (2438mm) and 108" (2743mm) lengths that are shipped fully assembled. All components have been properly sized to obtain the best performance from the Gen4 Super Ion Air Knife.

GEN4 Super Ion Air Knife Models with Plumbing Kit

Gen4 Super Ion Air Knife with Plumbing Kit - includes Super Air Knife, plumbing kit and Gen4 Ionizing Bar installed.

Gen4 Super Ion Air Knife Systems with Plumbing Kit - include Super Air Knife, plumbing kit and Gen4 Ionizing Bar installed. Includes Model 7960 Gen4 Power Supply (115V, 230V, 50/60Hz).

Gen4 Super Ion Air Knife Kits with Plumbing Kit - include Super Air Knife, plumbing kit and Gen4 Ionizing Bar installed. Also includes Model 7960 Gen4 Power Supply (115V, 230V, 50/60Hz), shim set, filter separator and pressure regulator (with coupler).



This 96" Long Gen4 Super Ion Air Knife cleans an acrylic sheet before protective wrap is applied.

Special length Gen4 Super Ion Air Knives and unlimited system lengths are available.

GO GREEN SAVE MONEY

Order EXAIR's EFC™ electronic flow control to minimize compressed air use. See page 7 for details.

Length	Gen4 Super Ion Air Knife Model	Gen4 Super Ion Air Knife Systems Model	Gen4 Super Ion Air Knife Kits Model
24" (610mm)	112024PKI	112124PKI	112224PKI
30" (762mm)	112030PKI	112130PKI	112230PKI
36" (914mm)	112036PKI	112136PKI	112236PKI
42" (1067mm)	112042PKI	112142PKI	112242PKI
48" (1219mm)	112048PKI	112148PKI	112248PKI
54" (1372mm)	112054PKI	112154PKI	112254PKI
60" (1524mm)	112060PKI	112160PKI	112260PKI
72" (1829mm)	112072PKI	112172PKI	112272PKI
84" (2134mm)	112084PKI	112184PKI	112284PKI
96" (2438mm)	112096PKI	112196PKI	112296PKI
108" (2743mm)	112108PKI	1121108PKI	1122108PKI

Static Eliminators

Accessories and Components

Model #	Description	Model #	Description
7960	2 Outlet Selectable Voltage Gen4 Power Supply (115V, 230V, 50/60Hz)	7905	Static Meter
7961	4 Outlet Selectable Voltage Gen4 Power Supply (115V, 230V, 50/60Hz)	9001	Auto Drain Filter Separator, 3/8 NPT, 65 SCFM (1,841 SLPM)
8003	3" (76mm) Gen4 Ionizing Bar Only	9032	Auto Drain Filter Separator, 1/2 NPT, 90 SCFM (2,549 SLPM)
8006	6" (152mm) Gen4 Ionizing Bar Only	9002	Auto Drain Filter Separator, 3/4 NPT, 220 SCFM (6,230 SLPM)
8009	9" (229mm) Gen4 Ionizing Bar Only	9066	Auto Drain Filter Separator, 1-1/4 NPT, 400 SCFM (11,327 SLPM)
8012	12" (305mm) Gen4 Ionizing Bar Only	9005	Oil Removal Filter, 3/8 NPT, 15-37 SCFM (425-1,048 SLPM)
8018	18" (457mm) Gen4 Ionizing Bar Only	9006	Oil Removal Filter, 3/4 NPT, 50-150 SCFM (1,416-4,248 SLPM)
8024	24" (610mm) Gen4 Ionizing Bar Only	9008	Pressure Regulator with Gauge, 1/4 NPT, 50 SCFM (1,416 SLPM)
8030	30" (762mm) Gen4 Ionizing Bar Only	9033	Pressure Regulator with Gauge, 1/2 NPT, 100 SCFM (2,832 SLPM)
8036	36" (914mm) Gen4 Ionizing Bar Only	9009	Pressure Regulator with Gauge, 3/4 NPT, 220 SCFM (6,230 SLPM)
8042	42" (1067mm) Gen4 Ionizing Bar Only	9067	Pressure Regulator with Gauge, 1-1/4 NPT, 600 SCFM (16,990 SLPM)
8048	48" (1219mm) Gen4 Ionizing Bar Only	9020	Solenoid Valve, 120V, 50/60Hz, 1/4 NPT, 40 SCFM (1,133 SLPM)
8054	54" (1372mm) Gen4 Ionizing Bar Only	9034	NEMA 4/4X Solenoid Valve, 120V, 50/60Hz, 1/2 NPT, 100 SCFM (2,832 SLPM)
8060	60" (1524mm) Gen4 Ionizing Bar Only	9035	NEMA 4/4X Solenoid Valve, 240V, 50/60Hz, 1/2 NPT, 100 SCFM (2,832 SLPM)
8072	72" (1829mm) Gen4 Ionizing Bar Only	9036	NEMA 4/4X Solenoid Valve, 120V, 50/60Hz, 3/4 NPT, 200 SCFM (5,664 SLPM)
8084	84" (2134mm) Gen4 Ionizing Bar Only	9037	NEMA 4/4X Solenoid Valve, 240V, 50/60Hz, 3/4 NPT, 200 SCFM (5,664 SLPM)
8096	96" (2438mm) Gen4 Ionizing Bar Only	9065	NEMA 4/4X Solenoid Valve, 24VDC, 1 NPT, 350 SCFM (9,911 SLPM)
80108	108" (2743mm) Gen4 Ionizing Bar Only		



Gen4[®] Standard Ion Air Knife™

A sheet of ionized air is an effective way to eliminate static and clean parts or materials!



The Model 8218 18" (457mm) Gen4 Standard Ion Air Knife System showers parts with static eliminating ions to prevent personnel shocks.

What Is The Gen4 Standard Ion Air Knife?

EXAIR's Gen4 Standard Ion Air Knife offers 30% improved performance at low pressures allowing you to achieve the same or better results, which saves compressed air and money. They are an effective way to eliminate static. Like its "super" counterpart, the Gen4 Standard Ion Air Knife removes static electricity from plastics, webs, sheet stock and other surfaces where tearing, jamming or hazardous shocks are a problem.

This ionizer uses our original Standard Air Knife to carry ions from a Gen4 Ionizing Bar to the charged surface - up to 20 feet (6.1m) away. Though not as efficient as our Gen4 Super Ion Air Knife (40:1 air amplification), the Gen4 Standard Ion Air Knife (30:1 air amplification) still provides fast static decay and strong blowoff force for cleaning. Force can be adjusted from a "blast" to a "breeze". The Gen4 Standard Ion Air Knife is electrically powered, is shockless and has no moving parts.

Why The Gen4 Standard Ion Air Knife?

When air consumption and noise level are not critical to the application, the lower cost makes the Gen4 Standard Ion Air Knife a good choice. (To compare the Gen4 Super Ion Air Knife and Gen4 Standard Ion Air Knife, see the performance tables on pages 122 and 128.)

Compressed air inlets are provided on each end of the Gen4 Standard Ion Air Knife. For long spans, multiple Gen4 Standard Ion Air Knives can be mounted end-to-end. This produces an air gap at the connection end of about 2" (51mm). (If no air gap is desired, use the Gen4 Super Ion Air Knife.) Special length Gen4 Ionizing Bars up to 119" (3.02m) are available for multiple air knife applications.

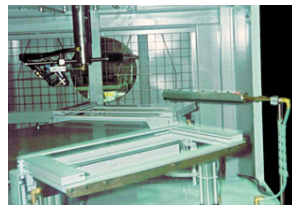

A Model 8212 12" (305mm) Gen4 Standard Ion Air Knife System cleans metal frames prior to powder coating.

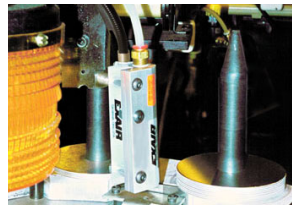

A Model 8103 3" (76mm) Gen4 Standard Ion Air Knife removes dust from computer hard disks prior to assembly.

Static Eliminators

Applications

- Web cleaning
- Molding machinery
- Sheeters and trimmers
- Cleaning parts
- Pre-paint dust removal
- Shrink wrappers
- Package cleaning
- Bag opening/fill operations
- Printing equipment

Advantages

- 30% improved performance
- Rugged metal armored and electromagnetically shielded cable
- Integrated ground eliminates additional ground connection
- Durable stainless steel connections to Power Supply
- Reduced air consumption
- 30:1 air amplification
- Low noise level
- Effective up to 20 feet (6.1m)
- Shockless, non-radioactive
- Compact, rugged, easy to install
- Unlimited system lengths
- Low maintenance
- Variable force and flow

GEN4® Standard Ion Air Knife

GEN4 Standard Ion Air Knife Performance

Pressure Supply		Air Consumption*		Sound Level	Dissipates 5kV**
PSIG	BAR	SCFM	SLPM	dBA	SECONDS
5	0.3	6	170	66	0.38
10	0.7	8	227	68	0.28
20	1.4	16	453	69	0.29
40	2.8	24	679	78	0.21
60	4.1	32	906	84	0.21
80	5.5	41	1,160	87	0.21
100	6.9	49	1,387	90	0.21

* per foot (305mm) of length ** 6" (152mm) from target.
For airflow pattern, see Standard Air Knife page 35.
Note: Performance on lengths over 36" will vary.
Contact an Application Engineer for details.



Kits include the Gen4 Standard Ion Air Knife, shim set, Model 7960 Gen4 Power Supply, filter separator and pressure regulator (with coupler).

Static Eliminators

GEN4 Standard Ion Air Knife Specifications

The Gen4 Standard Ion Air Knife is available in standard lengths of 3", 6", 9", 12", 18", 24", 30", 36", 42" and 48" (76, 152, 229, 305, 457, 610, 762, 914, 1067 and 1219mm).

Special lengths up to 48" (1219mm) and unlimited system lengths are available (please contact our factory).

A 5' (1.52m) armored and shielded power cable with ground and assembled bayonet connector are included. **EXAIR Model 7960 or 7961 Gen4 Power Supply (5kV) is required for Standard Ion Air Knife operation.** See page 140 for details.

Certifications: Gen4 Ionizing Bars and Gen4 Power Supplies are UL Component Recognized to U.S. and Canadian safety standards, and are CE and RoHS compliant.

Compressed Air: 1/4 NPT inlets are provided on each end.

Electrical: For use with 5 kVrms, 5 milliamperes (max.) power supply.

Electrical Hazard: Gen4 Ionizing Bars are shockless (less than 40 microamperes short circuited).

Do not use near flammable materials or gases.

Materials of Construction:

Metal Parts: Aluminum

Plastic Parts: UL rated 94 HB

Emitters: Stainless Steel

Maximum Ambient Temperature: 165°F (74°C)

Shims: Thicker shims can be installed easily if additional hard-hitting velocity is required, see "shim sets" page 34.



GEN4 Standard Ion Air Knife Models

Gen4 Standard Ion Air Knife - consists of the Standard Air Knife and Gen4 Ionizing Bar assembly. Does not include Power Supply.

Gen4 Standard Ion Air Knife Systems - include a Gen4 Standard Ion Air Knife and Model 7960 Gen4 Power Supply (115V, 230V, 50/60Hz).

Gen4 Standard Ion Air Knife Kits - include a Gen4 Standard Ion Air Knife, Model 7960 Gen4 Power Supply, shim set, filter separator and pressure regulator (with coupler).

Gen4 Deluxe Standard Ion Air Knife Kits - include a Gen4 Standard Ion Air Knife, EFC, Universal Mounting System, Model 7960 Gen4 Power Supply, shim set, filter separator and pressure regulator (with coupler).

Length	Gen4 Standard Ion Air Knife Model	Gen4 Standard Ion Air Knife Systems Model	Gen4 Standard Ion Air Knife Kits Model	Gen4 Deluxe Standard Ion Air Knife Kits Model
3" (76mm)	8103	8203	8403	8403DX
6" (152mm)	8106	8206	8406	8406DX
9" (229mm)	8109	8209	8409	8409DX
12" (305mm)	8112	8212	8412	8412DX
18" (457mm)	8118	8218	8418	8418DX
24" (610mm)	8124	8224	8424	8424DX
30" (762mm)	8130	8230	8430	8430DX
36" (914mm)	8136	8236	8436	8436DX
42" (1067mm)	8142	8242	8442	8442DX
48" (1219mm)	8148	8248	8448	8448DX

Special Length Gen4 Standard Ion Air Knives and unlimited system lengths are available. Please contact our factory.

Universal Air Knife Mounting System

EXAIR's Universal Air Knife Mounting System allows easy positioning of all EXAIR Air Knives. See page 29 for details.

GO GREEN **SAVE MONEY**

Order EXAIR's EFC™ electronic flow control to minimize compressed air use. See page 7 for details.

GEN4[®] Ionizing Bars

Low cost GEN4[®] Ionizing Bars eliminate static cling!

Compact, rugged design for industrial applications!

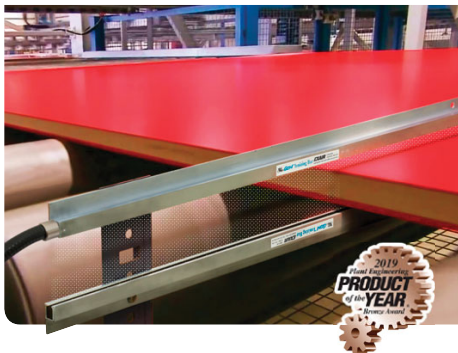

What Is The GEN4 Ionizing Bar?

EXAIR's Gen4 Ionizing Bar is engineered to perform up to 25% better than previous models for applications where the bar is mounted within 2" of the surface it is treating. It has also been designed to perform well 100% farther away by providing static elimination up to 4" from a charged surface. Gen4 Ionizing Bars eliminate static electricity on paper, film and plastics that can attract dust and foreign materials, ruin product appearance, produce tearing or jamming, and zap personnel. The electrically powered Gen4 Ionizing Bar is compact, allowing it to fit in the confined spaces of machinery, where the charge is generated. A high concentration of positive and negative ions produce fast static decay, neutralizing any surface within 4" (102mm) of the bar.

Why The GEN4 Ionizing Bar?

The unique design of the shockless Gen4 Ionizing Bar offers improved performance and reliability in industrial applications. Life expectancy has been extended by insertion molding the stainless steel ion emitters into a durable engineered polymer. There are no openings or grooves to accumulate dirt that could cause shorting or arcing. A 5kV power source provides high performance, eliminating frequent burnouts commonly associated with traditional 7kV bars.

The Gen4 Ionizing Bar includes a five foot shielded cable with ground. A mounting flange is provided for easy installation and all components are fully assembled. Standard lengths up to 108" (2743mm) are available from stock and special lengths up to 118" (3m) are available by special order. EXAIR Model 7960 or 7961 Gen4 Power Supply (5kV) is required for bar operation.

The ability to eliminate static can be greatly improved when attaching the Super Air Knife to the Gen4 Ionizing Bar. The Gen4 Super Ion Air Knife propels the static neutralizing ions over a larger area which is ideal for high speed, high charge applications. Air delivery can also remove dust and clean the product surface.

Static Eliminators

Applications

- Labeling
- Bag making - form and fill
- Neutralizing shrink wrap
- Sheet fed and web presses
- Packaging
- Converting machinery
- Neutralizing slitting operations
- Textiles
- Screen printing

Advantages

- Significantly improved performance when positioned 2" or closer to a surface
- Capable of minimizing static charge from up to 4" away
- Rugged metal armored and electromagnetically shielded cable
- Integrated ground eliminates additional ground connection
- Durable stainless steel connections to Power Supply
- Low cost
- Rapid static decay
- Compact
- Effective up to 4" (102mm)
- Shockless, non-radioactive
- Rugged design for industrial environments
- Easy to install, equipped with mounting flange
- Low maintenance
- Fully assembled

How The GEN4 Ionizing Bar Works

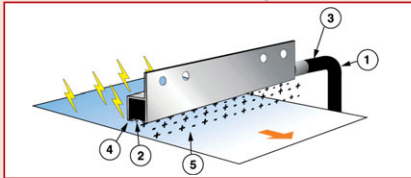

The electromagnetically shielded power cable (1) carries the 5kVrms power supply output to each inductively coupled stainless steel emitter point (2) of the Gen4 Ionizing Bar. An integrated ground wire (3) within the power cable creates a discharge path from the emitter points to the bar channel (4). The discharge at each emitter charges the molecules of the gases of the surrounding room air, resulting in a shower of ions that are positively and negatively charged (5). If the material surface has a negative charge, it will attract the positive ions from the Gen4 Ionizing Bar and become balanced or neutralized. If the material surface has a positive charge, it will attract the negative ions from the Gen4 Ionizing Bar to become balanced or neutralized.

The voltage potential at each emitter is high enough to ionize the surrounding air without generating a shock when any of the emitters are touched.

GEN4 Ionizing Bar Specifications

EXAIR Model 7960 or 7961 Gen4 Power Supply (5kV) is required for Ionizing Bar operation. See page 140 for details.

Certifications: Gen4 Ionizing Bars and Gen4 Power Supplies are UL Component Recognized to U.S. and Canadian safety standards, and are CE and RoHS compliant.



Electrical: For use with 5 kVrms, 5 milliamperes (max.) power supply.

Electrical Hazard: Gen4 Ionizing Bars are shockless (less than 40 microamperes short circuited).

Do not use near flammable materials or gases.

Materials of Construction:

Metal Parts: Aluminum

Plastic Parts: UL rated 94 HB

Emitters: Stainless Steel

Maximum Ambient Temperature: 165°F (74°C)

GEN4 Ionizing Bar Performance

	Distance From Charged Surface				
	0.50" (13mm)	1" (25mm)	2" (51mm)	3" (76mm)	4" (102mm)
Disipates 5kV* (seconds)	0.1	0.14	0.29	0.53	0.96

* Multiple different length Ionizing Bars tested (3"-48").

GEN4 Ionizing Bar Dimensions

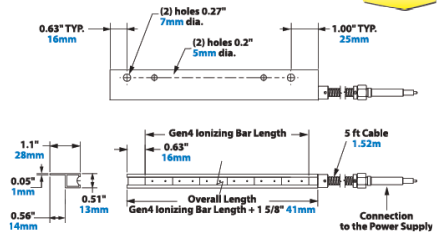

GEN4 Ionizing Bars

Gen4 Ionizing Bars - include a 5' (1.52m) length of armored and electromagnetically shielded cable and assembled connector. For other cable lengths, please contact the factory.

Length	Gen4 Ionizing Bar Models
3" (76mm)	8003
6" (152mm)	8006
9" (229mm)	8009
12" (305mm)	8012
18" (457mm)	8018
24" (610mm)	8024
30" (762mm)	8030
36" (914mm)	8036
42" (1067mm)	8042
48" (1219mm)	8048
54" (1372mm)	8054
60" (1524mm)	8060
72" (1829mm)	8072
84" (2134mm)	8084
96" (2438mm)	8096
108" (2743mm)	80108

Accessories and Components

Model # Description

7960	2 Outlet Selectable Voltage Gen4 Power Supply (115V, 230V, 50/60Hz)
7961	4 Outlet Selectable Voltage Gen4 Power Supply (115V, 230V, 50/60Hz)
7905	Static Meter



Model 8006 6" (152mm) Gen4 Ionizing Bar and Model 7960 Gen4 Power Supply.

Special length Gen4 Ionizing Bars up to 119" (3.02m) are available. Please contact our factory.



GET4[®] Super Ion Air Wipe™

Ring of ionized airflow clamps around the part!

Neutralizes and cleans continuous moving surfaces!

What Is The GET4 Super Ion Air Wipe?

EXAIR's Gen4 Super Ion Air Wipe provides a uniform 360° ionized airstream that is easy to clamp around a part for eliminating static electricity and contaminants. It is ideal for use on pipe, cable, extruded shapes, hose, wire and more. It maximizes ionized airflow while minimizing compressed air consumption.

Why The GET4 Super Ion Air Wipe?

The Gen4 Super Ion Air Wipe provides total coverage of the part moving through it. The high volume, high velocity flow attaches itself to the surface and wipes it down with the static eliminating ions. The airflow stays attached to the surface and is effective up to 15' (4.6m) away from where the Gen4 Super Ion Air Wipe is mounted. An optional pressure regulator provides infinite control of the air volume and velocity. Increasing the pressure increases the forceful wiping action. Lower pressures provide excellent coverage with much lower force and velocity.

The Gen4 Super Ion Air Wipe is the easy way to provide uniform coverage around a continuously moving material. The hinged design, allowing the Air Wipe to open, makes threading continuous wire, tube or extrusions unnecessary. Arranging a series of other ionizers around the surface would provide uneven airflow and prove to be costly. The split design of the Gen4 Super Ion Air Wipe solves that problem by making it easy to clamp around the surface of the material moving through it, eliminating the need for threading or several ionizers.

The Gen4 Super Ion Air Wipe is lightweight and easy to mount using the tapped holes on the back. It can also be held in place with rigid pipe. Coupling brackets that hold each half of the Gen4 Super Ion Air Wipe together are provided which can be installed or removed quickly if required.

Applications

- Clean and neutralize extrusions
- Neutralizing pipe, tubing, wire
- Cleaning molded parts
- Neutralizing static for quality printing
- Pre-paint dust removal
- Remove chips, shavings and sawdust
- Container neutralization

Advantages

- Low air consumption
- Rapid static decay
- Quiet
- Shockless, non-radioactive
- Compact, rugged, easy to install
- No moving parts - low maintenance
- Variable force and flow
- Electromagnetically shielded high voltage cable
- Armored high voltage cable protects against abrasion, cuts
- Integrated ground design requires no separate ground connection
- Replaceable emitter points

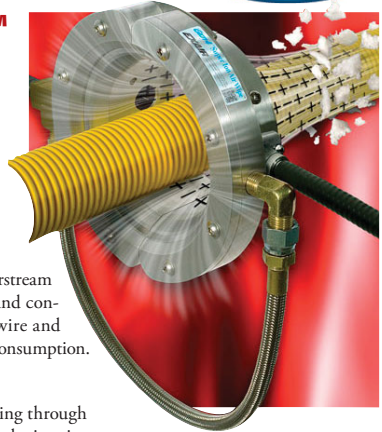

Static Eliminators

The split design unlatches easily to fit around the moving part - no threading required.



The Gen4 Super Ion Air Wipe is available in a 2" (51mm) and 4" (102mm) diameter.

GET4® Super Ion Air Wipe

How The GET4 Super Ion Air Wipe Works

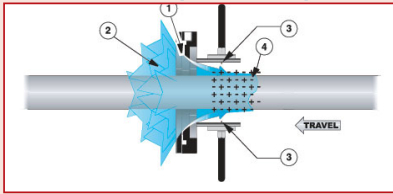

The Gen4 Super Ion Air Wipe incorporates a Super Air Wipe and a split ionizing collar, energized by a power supply. Compressed air is ejected through the small ring nozzle of the Super Air Wipe at high velocity (1). A conical 360° ring of air is created that induces high volumes of surrounding air (2). The airflow passes through the collar and is ionized by two replaceable emitter points (3). That high velocity, ionized airstream attaches itself to the surface of the material running through the Gen4 Super Ion Air Wipe (4), uniformly eliminating the static electricity and removing any contaminants from the surface.

GET4 Super Ion Air Wipe Specifications

EXAIR Model 7960 or 7961 Gen4 Power Supply (5kV) is required for Super Ion Air Wipe operation.

See page 140 for details.

Certifications: The Gen4 Super Ion Air Wipe and Gen4 Power Supply are UL Component Recognized to U.S. and Canadian safety standards, and are CE and RoHS compliant.



Electrical: For use with 5 kVrms, 5 milliamperes (max.) power supply.

Electrical Hazard: Shockless (less than 40 microamperes short circuited).

Do not use near flammable materials or gases.

Materials of Construction:

Metal Parts: Aluminum **Emitter:** Stainless Steel

Plastic Parts: UL rated 94 HB

Maximum Ambient Temperature: 165°F (74°C)

Shims: Thicker shims can be installed easily if additional hard-hitting velocity is required. See "shim sets" page 41.

Compressed Air: 1/4 NPT inlet provided.

GET4 Super Ion Air Wipe Performance

80 PSIG (5.5 BAR)	Air Consumption		Sound Level	Dissipates 5kV*
MODEL	SCFM	SLPM	dBA	SECONDS
8162	29.5	835	77	0.20
8164	50.2	1,422	81	0.20

* 12" (305mm) from target.

GET4 Super Ion Air Wipe Dimensions

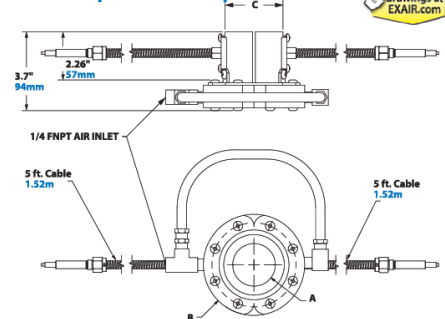

MODEL	A	B	C
8162	2" (51mm)	4.75" (121mm)	2.7" (69mm)
8164	4" (102mm)	6.75" (171mm)	4.72" (120mm)

Static Eliminators



Model 8462 Gen4 Super Ion Air Wipe Kit includes the Gen4 Super Ion Air Wipe, shim set, Model 7960 Gen4 Power Supply, filter separator and pressure regulator (with coupler).

GET4 Super Ion Air Wipe

Model #	Description
8162	2" (51mm) Gen4 Super Ion Air Wipe
8164	4" (102mm) Gen4 Super Ion Air Wipe
8262	2" (51mm) Gen4 Super Ion Air Wipe and Gen4 Power Supply
8264	4" (102mm) Gen4 Super Ion Air Wipe and Gen4 Power Supply

GET4 Super Ion Air Wipe Kits

Kits include a Gen4 Super Ion Air Wipe, shim set, Model 7960 Gen4 Power Supply, filter separator and pressure regulator (with coupler).

Model #	Description
8462	2" (51mm) Gen4 Super Ion Air Wipe Kit
8464	4" (102mm) Gen4 Super Ion Air Wipe Kit

Accessories and Components

Model #	Description
7960	2 Outlet Selectable Voltage Gen4 Power Supply (115V, 230V, 50/60Hz)
7961	4 Outlet Selectable Voltage Gen4 Power Supply (115V, 230V, 50/60Hz)
9001	Auto Drain Filter Separator, 3/8 NPT, 65 SCFM (1,841 SLPM)
9008	Pressure Regulator with Gauge, 1/4 NPT, 50 SCFM (1,415 SLPM)
7905	Static Meter





Gen4[®] Ion Air Cannon™

Quiet, efficient, concentrated flow of ionized air removes static and dust!



What Is The Gen4 Ion Air Cannon?

EXAIR's Gen4 Ion Air Cannon neutralizes static electricity and cleans at distances up to 15 feet (4.6m) with no moving parts. It is ideal for those hard to reach spaces or confined areas that require a concentrated flow of static eliminating ions. With an optional pressure regulator, the air volume and velocity are infinitely adjustable over a wide range, for light to heavy duty applications.

Why The Gen4 Ion Air Cannon?

The Gen4 Ion Air Cannon will **maximize ionized airflow while minimizing compressed air consumption**. A small amount of compressed air is used to entrain a high volume flow of surrounding air. This combined stream is ionized by an emitter point (shockless) and delivered to the charged surface. A hose or tube can be connected to the air intake of the Gen4 Ion Air Cannon to draw quality air from another area. It requires only 10 PSIG (0.7 BAR) for most applications.

The compact design saves bench space and allows mounting in confined areas. The sturdy stand is pre-drilled and can be wall, bench or machine mounted. It incorporates a swivel adjustment for directing the airflow.

EXAIR's EFC (shown on page 7) is an electronic flow control for compressed air. For production lines, it can sense when no part is present and will automatically turn off the compressed air to the Gen4 Ion Air Cannon until the next part moves into position.



The Model 8292 Gen4 Ion Air Cannon System eliminates the static and dust prior to filling the bottles.



(3) Gen4 Ion Air Cannons blow contaminants from car bodies prior to painting.

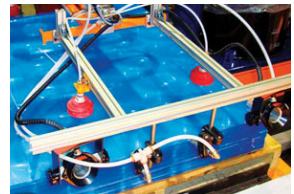

Model 8192 Gen4 Ion Air Cannons provide static elimination in between solar panel lenses to assist separation of the lenses during production.

Static Eliminators

Applications

- Bag opening - form and fill
- Clean and neutralize parts
- Neutralizing shrink wrap
- Cleaning molded parts
- Removing static on assemblies
- Pre-paint dust removal
- Neutralizing slitting operations
- Package cleaning
- Container neutralization

Advantages

- Electromagnetically shielded high voltage cable
- Armored high voltage cable protects against abrasion, cuts
- Integrated ground design requires no separate ground connection
- Replaceable emitter point
- Low air consumption
- Rapid static decay
- Quiet
- Shockless, non-radioactive
- Compact, rugged, easy to install
- Intake can be ducted
- No moving parts - low maintenance
- Variable force and flow

How The GET4 Ion Air Cannon Works

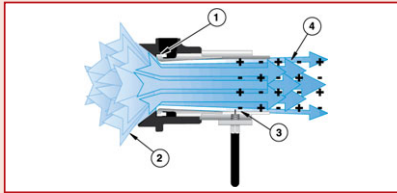

The Gen4 Ion Air Cannon incorporates a Super Air Amplifier* and ionizing collar, energized by a power supply. A small amount of compressed air is injected into the barrel of the cannon (1) inducing a high volume flow of surrounding air to flow through it (2). A replaceable emitter point at the discharge end of the cannon (3) ionizes the entire airstream. The result is a high volume, conical flow of ionized air (4) capable of eliminating static and cleaning at distances up to 15 feet (4.6m). Because more than 90% of the ionized air is induced, the Gen4 Ion Air Cannon produces maximum airflow at minimum air consumption.

*Patent #5402938



Model 8492 Gen4 Ion Air Cannon Kit includes the Gen4 Ion Air Cannon, shim set, Model 7960 Gen4 Power Supply, filter separator and pressure regulator (with coupler).

GET4 Ion Air Cannon

Model #	Description
8192	Gen4 Ion Air Cannon includes Super Air Amplifier, Emitter, Stand, and 5' (1.52m) length of armored and electromagnetically shielded cable
8292	Gen4 Ion Air Cannon and Gen4 Power Supply
8492	Gen4 Ion Air Cannon Kit (see image above)

GET4 Deluxe Ion Air Cannon Kits

Model #	Description
8492DX	Kits include a Gen4 Ion Air Cannon, EFC, shim set, Model 7960 Gen4 Power Supply, filter separator and pressure regulator (with coupler).

Accessories and Components

Model #	Description
7960	2 Outlet Selectable Voltage Gen4 Power Supply (115V, 230V, 50/60Hz)
7961	4 Outlet Selectable Voltage Gen4 Power Supply (115V, 230V, 50/60Hz)
9001	Auto Drain Filter Separator, 3/8 NPT, 65 SCFM (1,841 SLPM)
9008	Pressure Regulator with Gauge, 1/4 NPT, 50 SCFM (1,415 SLPM)
7905	Static Meter

GET4 Ion Air Cannon Specifications

EXAIR Model 7960 or 7961 Gen4 Power Supply (5kV) is required for Ion Air Cannon operation.

See page 140 for details.

Certifications: The Gen4 Ion Air Cannon and Gen4 Power Supply are UL Component Recognized to U.S. and Canadian safety standards, and are CE and RoHS compliant.

Electrical: For use with 5 kVrms, 5 milliamperes (max.) power supply.

Electrical Hazard: Shockless (less than 40 microamperes short circuited).

Do not use near flammable materials or gases.

Materials of Construction:

Metal Parts: Aluminum

Plastic Parts: UL rated 94 HB Emitter: Stainless Steel

Maximum Ambient Temperature: 165°F (74°C)

Shims: Thicker shims can be installed easily if additional hard-hitting velocity is required. See page 49.

Compressed Air: 3/8 NPT inlet provided.



GET4 Ion Air Cannon Performance

PSIG	Pressure Supply		Air Consumption		Sound Level	Dissipates 5kV*
	BAR	SCFM	SLPM	dBA	SECONDS	
20	1.4	5.7	161	58	0.75	
40	2.8	9	255	64	0.6	
60	4.1	12.2	345	70	0.5	
80	5.5	15.5	439	72	0.43	
100	6.9	18.7	529	74	0.37	

* 12" (305mm) from target. For airflow pattern, see Super Air Amplifier on page 49.

GET4 Ion Air Cannon Dimensions

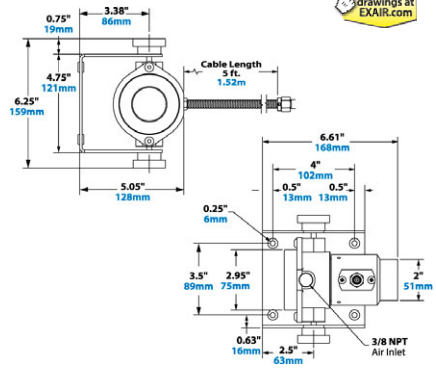



GET4[®] Ion Air Gun™

Rugged, ergonomic static eliminating gun is a lightweight, effective spot cleaner!



What Is The GET4 Ion Air Gun?

EXAIR's Gen4 Ion Air Gun combines incredibly fast static decay rates with low compressed air consumption. It is the ideal way to remove static, contaminants and dust from three dimensional parts prior to assembly, packaging, painting or finishing. The Gen4 Ion Air Gun neutralizes static electricity and cleans at distances up to 15 feet (4.6m).

Why The GET4 Ion Air Gun?

The Gen4 Ion Air Gun induces surrounding airflow through the gun at a ratio of 5:1, minimizing compressed air usage and maximizing ionized airflow. The force can be adjusted from a "blast" to a "breeze". A comfortable grip and hand position allows hours of continuous use without fatigue.

The Gen4 Ion Air Gun is quiet, lightweight and features a hanger hook for easy storage. The 10 foot (3m) armored and electromagnetic shielded power cable is extremely flexible, designed for rugged industrial use.



The Model 8293 Gen4 Ion Air Gun cleaning artwork and glass prior to framing.

Static Eliminators

Applications

- Pre-paint dust removal
- Clean and neutralize three dimensional parts
- Removing dust from optics
- Cleaning molded parts
- Photo finishing
- Lens cleaning
- Furniture finishing
- Package cleaning
- Container neutralization

Advantages

- Electromagnetically shielded high voltage cable
- Armored high voltage cable protects against abrasion, cuts
- Integrated ground design requires no separate ground connection
- Replaceable emitter point
- Rugged, lightweight, easy to use
- Rapid static decay
- Low air consumption
- Quiet
- Shockless, non-radioactive
- Strong blowoff force and flow
- Low maintenance
- Meets OSHA pressure and noise level requirements



The Model 8293 Gen4 Ion Air Gun neutralizes and cleans plastic bottles prior to labeling.

Gen4[®] Ion Air Gun

How The Gen4 Ion Air Gun Works

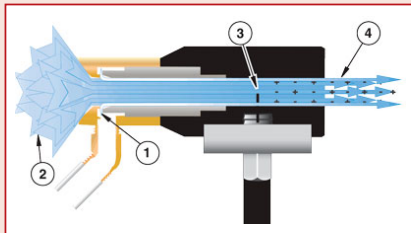

The Gen4 Ion Air Gun incorporates a High Velocity Air Jet and electrically energized emitter point. A small amount of compressed air is injected into the air jet (1) inducing high volume flow of surrounding air (2) to pass through it.

The emitter point (shockless) at the discharge end of the gun (3) ionizes the entire airstream. **The result is a high volume flow of ionized air (4) capable of neutralizing high static charges in fractions of a second.** An optional filter and regulator clean the compressed air and allow infinite adjustment of airflow and velocity.

Gen4 Ion Air Gun Specifications

EXAIR Model 7960 or 7961 Gen4 Power Supply (5kV) is required for Ion Air Gun operation. See page 140 for details.

Certifications: The Gen4 Ion Air Gun and Gen4 Power Supply are UL Component Recognized to U.S. and Canadian safety standards, and are CE and RoHS compliant.



Electrical: For use with 5 kVrms, 5 milliamperes (max.) power supply.

Electrical Hazard: Shockless (less than 40 microamperes short circuited).

Do not use near flammable materials or gases.

Materials of Construction:

Metal Parts: Brass, Zinc and Stainless Steel

Plastic Parts: UL rated 94 HB **Emitter:** Stainless Steel

Maximum Ambient Temperature: 165°F (74°C)

Compressed Air: 1/4 NPT inlet provided.



80% of the delivered air is induced, minimizing air consumption of the Gen4 Ion Air Gun.

Gen4 Ion Air Gun Performance

PSIG	BAR	Air Consumption		Sound Level	Dissipates 5kV*
		SCFM	SLPM		
20	1.4	7.4	209	67	0.45
40	2.8	11.5	325	74	0.33
60	4.1	15.8	447	79	0.24
80	5.5	22.0	622	82	0.18
100	6.9	24.0	679	85	0.18

* 6" (152mm) from target. For airflow pattern, see Model 6013 High Velocity Air Jet on page 61.



Model 8493 Gen4 Ion Air Gun Kit includes the Gen4 Ion Air Gun, Model 7960 Gen4 Power Supply, filter separator and pressure regulator (with coupler).

Order Direct
We Ship From Stock



GEN4[™] Ion Air Jet[™]

Air saving Gen4 Ion Air Jet is an effective spot cleaner!

Choose permanent mount or flexible hose with base!

What Is The GEN4 Ion Air Jet?

EXAIR's Gen4 Ion Air Jet delivers a concentrated airflow that can cover a precise spot without disturbing other areas. This quiet, focused airstream provides incredibly fast static decay rates and cleaning ability. The Gen4 Ion Air Jet is the ideal way to remove static and dust from small parts prior to shrink wrapping, packaging, printing, painting or finishing.

Why The GEN4 Ion Air Jet?

The Gen4 Ion Air Jet induces surrounding airflow at a ratio of 5:1, minimizing compressed air use and maximizing ionized airflow. Force can be adjusted from a "blast" to a "breeze".

Your Choice Of Permanent Mount or Flexible Stay Set Hose[™]

For permanent mount applications, the compact Gen4 Ion Air Jet is the best choice since it is lightweight and easy to install using the 1/8 NPT male inlet. For applications where frequent repositioning is required, the flexible Gen4 Stay Set Ion Air Jet[™] is ideal. This version can be placed in close proximity and the hose bent to aim the ionized airstream at the localized area. Since the hose has "memory" it will not creep or bend, always keeping the aim until physically moved to the next position.

The Gen4 Stay Set Ion Air Jet comes complete with a magnetic base that allows easy mounting and portability on a machine, a bench or other surface. A shutoff valve on the base provides infinite control of the force and flow. For hands free operation, an optional Model 9040 Foot Pedal (requires floor or machine mounting) is available.

Applications

- Three dimensional parts
- Bottle cleaning
- Screen printing
- Shrink bands
- Ink jet printing
- Part cleaning
- Package cleaning

Advantages

- Low cost
- Rapid static decay
- Quiet
- Shockless, non-radioactive
- Electromagnetically shielded high voltage cable
- Armored high voltage cable protects against abrasion, cuts
- Integrated ground design requires no separate ground connection
- Replaceable emitter point
- Compact, rugged, easy to install
- Stay Set Hose for accurate placing
- Low air consumption

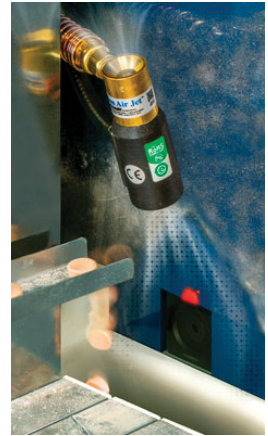

The Model 8294 Gen4 Ion Air Jet with Gen4 Power Supply neutralizes static and removes dust from a counting sensor window on a tablet production machine.

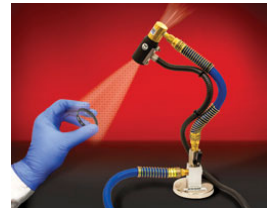

The Model 8194-9362 Gen4 Stay Set Ion Air Jet Kit cleans dust from a glass lens prior to installation on a gauge.



The Gen4 Model 8910 Instant Static Elimination Station removes contaminants on plastic fittings prior to packaging.

Static Eliminators

GEN4[®] Ion Air Jet

How The GEN4 Ion Air Jet Works

The Gen4 Ion Air Jet functions the same as the Gen4 Ion Air Gun without the blowgun handle. For details on how it works, see page 136 "How The Gen4 Ion Air Gun Works".

GEN4 Ion Air Jet Performance

Pressure Supply		Air Consumption		Sound Level	Dissipates 5kV*
PSIG	BAR	SCFM	SLPM	dBA	SECONDS
20	1.4	7.4	209	67	0.45
40	2.8	11.5	325	74	0.33
60	4.1	15.8	447	79	0.24
80	5.5	22.0	622	82	0.18
100	6.9	24.0	679	85	0.18

* 6" (152mm) from target. For airflow pattern, see Model 6013 High Velocity Air Jet on page 61.

GEN4 Ion Air Jet Dimensions

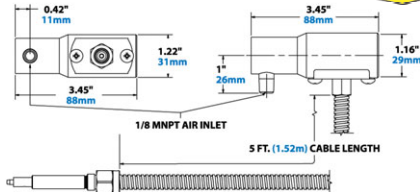

GEN4 Ion Air Jet

Model # Description

8194	Gen4 Ion Air Jet Only includes 5' (1.52m) armored and electromagnetically shielded cable*
8294	Gen4 Ion Air Jet and Gen4 Power Supply
8494	Gen4 Ion Air Jet Kit includes Gen4 Power Supply, filter separator and pressure regulator (with coupler).

GEN4 Stay Set Ion Air Jet

Model # Description

8194-9362	Gen4 Stay Set Ion Air Jet includes 5' (1.52m) armored and electromagnetically shielded cable*, one outlet magnetic base with shutoff valve and 12" (305mm) Stay Set Hose.
8294-9362	Gen4 Stay Set Ion Air Jet and Model 7960 Gen4 Power Supply (115V, 230V, 50/60Hz)
8494-9362	Gen4 Stay Set Ion Air Jet Kit (see detail at right)
8495-9362	Gen4 Deluxe Stay Set Ion Air Jet Kit (see detail at right)
8910	Gen4 Instant Static Elimination Station (see detail at right)

* For special length cables, please contact the factory.

Accessories and Components

Model # Description

7960	2 Outlet Selectable Voltage Gen4 Power Supply (115V, 230V, 50/60Hz)
7961	4 Outlet Selectable Voltage Gen4 Power Supply (115V, 230V, 50/60Hz)
9001	Auto Drain Filter Separator, 3/8 NPT, 65 SCFM (1,841 SLPM)
9008	Pressure Regulator with Gauge, 1/4 NPT, 50 SCFM (1,415 SLPM)
7905	Static Meter

GEN4 Ion Air Jet Specifications

EXAIR Model 7960 or 7961 Gen4 Power Supply (5kV) is required for Ion Air Jet operation. See page 140 for details.

Certifications: The Gen4 Ion Air Jet and Gen4 Power Supply are UL Component Recognized to U.S. and Canadian safety standards, and are CE and RoHS compliant.



Electrical: For use with 5 kVrms, 5 milliamperes (max.) power supply.

Electrical Hazard: Shockless (less than 40 microamperes short circuited).

Do not use near flammable materials or gases.

Materials of Construction:

Metal Parts: Brass and Stainless Steel

Plastic Parts: UL rated 94 HB

Emitter: Stainless Steel

Maximum Ambient Temperature: 165°F (74°C)

Compressed Air: 1/8 NPT inlet provided on Gen4 Ion Air Jet.

1/4 NPT inlet provided on Gen4 Stay Set Ion Air Jet.



Model 8494 Gen4 Ion Air Jet Kit includes the Gen4 Ion Air Jet, Model 7960 Gen4 Power Supply, filter separator and pressure regulator (with coupler).



Model 8494-9362 Gen4 Stay Set Ion Air Jet Kit includes the Gen4 Stay Set Ion Air Jet, Model 7960 Gen4 Power Supply, filter separator and pressure regulator (with coupler).



Model 8910 Gen4 Instant Static Elimination Station includes the Gen4 Stay Set Ion Air Jet, Model 7960 Gen4 Power Supply, foot pedal and (2) 10' (3m) hoses.



Model 8495-9362 Gen4 Deluxe Stay Set Ion Air Jet Kit includes the Gen4 Stay Set Ion Air Jet, Model 7960 Gen4 Power Supply, filter separator and pressure regulator (with coupler), foot pedal and 10' (3m) hose.

GET4[®] Ionizing Point™

Single point ionizer for spot neutralization!

What Is The GET4 Ionizing Point?

EXAIR's Gen4 Ionizing Point is a compact, single point ionizer ideal for winding, rewinding or slitting operations. It can also be mounted through a duct to neutralize static charges due to moving air or materials.

The shockless Gen4 Ionizing Point delivers a high concentration of positive and negative ions for fast static decay. It can neutralize any surface within 2" (51mm).

GET4 Ionizing Point Dimensions

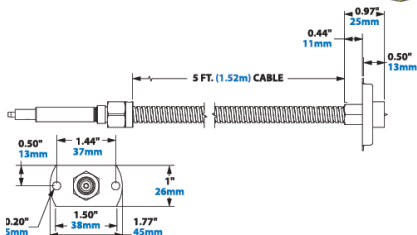

GET4 Ionizing Point Performance

	Distance From Charged Surface		
	0.50" (13mm)	1" (25mm)	2" (51mm)
Dissipates 5kV (seconds)	0.12	0.18	0.24

Applications

- Winding
- Rewinding
- Slitting
- Neutralizing ducted air

Advantages

- Electromagnetically shielded high voltage cable
- Armored high voltage cable protects against abrasion, cuts
- Integrated ground design requires no separate ground connection
- Low cost
- Replaceable emitter point
- Rapid static decay
- Shockless
- Non-radioactive
- Compact



Gen4 Ionizing Points remove static from a card slitting operation.

GET4 Ionizing Point Specifications

EXAIR Model 7960 or 7961 Gen4 Power Supply (5kV) is required for Ionizing Point operation. See page 140 for details.

Certifications: The Gen4 Ionizing Point and Gen4 Power Supply are UL Component Recognized to U.S. and Canadian safety standards, and are CE and RoHS compliant.

Electrical: For use with 5 kVrms, 5 milliamperes (max.) power supply.

Electrical Hazard: Shockless (less than 40 microamperes short circuited).

Do not use near flammable materials or gases.

Materials of Construction:

- Metal Parts:** Stainless Steel
- Plastic Parts:** UL rated 94 HB
- Emitter:** Stainless Steel

Maximum Ambient Temperature: 165°F (74°C)



The Model 8299 Gen4 Ionizing Point System includes the Gen4 Ionizing Point and Model 7960 Gen4 Power Supply.

GET4 Ionizing Point

Model #	Description
8199	Gen4 Ionizing Point Only includes 5' (1.52m) shielded cable*
8299	Gen4 Ionizing Point System (see detail above)

* For special length cables, please contact the factory.

Accessories and Components

Model #	Description
7960	2 Outlet Selectable Voltage Gen4 Power Supply (115V, 230V, 50/60Hz)
7961	4 Outlet Selectable Voltage Gen4 Power Supply (115V, 230V, 50/60Hz)
7905	Static Meter

Gen4[®] Power Supplies

Selectable Voltage:
For use with all Gen4
Static Eliminators!



The Model 7960 Gen4 Power Supply has 115VAC or 230VAC selectable voltage, lighted power switch, integral fuse on the primary, electromagnetically shielded modular power cable and (2) 5kV outlets.

Why Use Gen4 Power Supplies?

The two and four outlet Gen4 Power supplies have selectable voltage which allows you to choose input voltages of 115VAC or 230VAC. The modular cable with electromagnetic shielding protects sensitive electronics against electromagnetic interference while easing connections and routing. An integrated fuse on the primary protects against voltage spikes.

Gen4 Power Supplies

The Two and Four Outlet selectable voltage Gen4 Power Supplies require an input of 115VAC, 50/60 Hz or 230VAC, 50/60 Hz. A 6' (1.83m) modular power cord and lighted power switch are included. Power Supplies are UL Component Recognized to U.S. and Canadian safety standards, and are CE and RoHS compliant.



The Model 7961 Gen4 Power Supply has 115VAC or 230VAC selectable voltage, lighted power switch, integral fuse on the primary, electromagnetically shielded modular power cable and (4) 5kV outlets.

Static Eliminators



Gen4 Power Supplies: Selectable Voltage

Model #	Description
7960	2 Outlet Selectable Voltage Gen4 Power Supply (115V, 230V, 50/60Hz)
7961	4 Outlet Selectable Voltage Gen4 Power Supply (115V, 230V, 50/60Hz)

Advantages

- Replaceable rocker switch
- Durable, stainless steel high voltage connections
- Selectable voltage 115VAC or 230VAC
- Electromagnetically shielded modular power cable
- Fuse protects against voltage spikes
- Modular power supply cable eases connections and routing.

Order Direct
We Ship From Stock

Gen4 Power Supply Dimensions



INPUT VOLTAGE: 115/230 VAC
INPUT CURRENT: 2/1 A MAX
FREQUENCY: 50/60 HZ

OUTPUT VOLTAGE: 5000 Vrms
OUTPUT CURRENT: 5 mA MAX

Model 7960

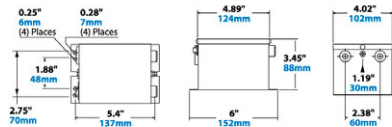

Model 7961

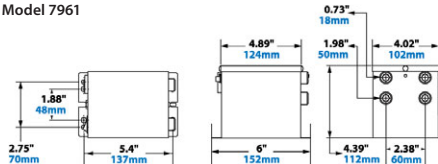



Intellistat Ion Air Gun

**An INTELLIGENT
COMPRESSED AIR®
Product**

Intellistat® Ion Air Gun™

**Lightweight solution for static
and particulate elimination
in sensitive processes!**

**Rated Class 5 for clean rooms and
controlled environments per ISO 14644-1**

What is the Intellistat Ion Air Gun?

The patented Intellistat is the newest innovation in a long line of EXAIR static elimination solutions. This intelligent product utilizes balanced and ionized compressed air to neutralize static and remove troublesome particulates during clean processes, test procedures and sensitive assembly work. With a +/-30 volt offset, the Intellistat was designed to consume minimal compressed air while simultaneously delivering precise blow-off and exceptional static decay rates capable of reducing 5000 volts to less than 500 in under one second. The design hosts an efficient, low voltage transformer converting 120V to 24V to assure safety, while also utilizing an EXAIR engineered air nozzle ensuring it meets all OSHA requirements for sound level and dead-end pressure.

Why the Intellistat Ion Air Gun?

Coming equipped with a short-throw, fast acting and effortless trigger, the Intellistat's lightweight frame (less than 200 grams) allows extended use without fatigue, while also providing a dependable and low maintenance solution. The Model 8500 Intellistat Ion Air Gun is also fitted with handy features such as a 6mm air connection, red and green LED lights to signify ionized air is being produced, and a hook for convenient hanging and storage. The 316SS emitter point is so simple to change, it can be completed in less than one minute. The housing is made of a durable static dissipative polycarbonate to further minimize any potential for static electricity discharge around sensitive electronics, sensors or materials. It will produce clean, ionized compressed air essential for removing dust, static, or particulate contaminants in sterile environments such as laboratories, clean rooms, or scientific testing.

EU Regd. Des. No. 00770318-0001

Pat. D903,817

©EXAIR Corporation, Mexico No. 60723, Canada No. 194141



Static
Eliminators

Applications

- Precision parts assembly
- Maintain charge neutrality in laboratory processes
- Remove particles from parts and surfaces in clean environments
- Printed circuit board manufacturing
- Maintain cleanliness during electronics manufacturing and assembly
- Eliminating electrostatic discharge
- Remove debris from medical products
- Clean glass containers, slides and lenses

Advantages

- Rapid static decay
- Low voltage operation
- Quick change emitter point
- Comfortable, short throw trigger for ionization
- Light weight for prolonged use
- OSHA safe air outlet
- LED indicators for proper and improper functionality

Intellistat Ion Air Gun

How The Intellistat Ion Air Gun Works



Pressing the full finger, short throw trigger (1) activates the static eliminating ions and airflow. Proper or improper functionality is indicated by a green or red LED (2). The non-marring nozzle (3) provides quiet performance and OSHA compliance. A hanger hook (4) is included to keep the Intellistat conveniently stored.

Intellistat Ion Air Gun Specifications

Certifications: The Intellistat Ion Air Gun is UL listed and CE and RoHS compliant.

Power Supply Input: 100-240V — 50/60 Hz 0.7A Max

Power Supply Output: EXAIR Model 902067 Power Supply (24VDC, 1.0A Max) is required for Intellistat Ion Air Gun operation. Included with Intellistat Ion Air Gun.

Electrical Hazard: Shockless (less than 40 microamperes short circuited)

Do not use near flammable materials or gases.

Balance: ±30V

Size of Hand Unit: 6-3/8"W x 6-3/4"L x 1"H

Weight of Hand Unit: 0.42 lbs

Operating Temperature: 32°F to 105°F (0-41°C)

Do not use near flammable materials or gases.

Materials of Construction:

Plastic Parts: Static Resistant Polycarbonate

Emitters: Stainless Steel

Gas Input: 30psi - 125psi

Clean Dry Compressed Air or Nitrogen

Air Connection: 6mm tube

Cleanroom Classification: ISO 14644-1 Class 5, operational.



Static Eliminators

Intellistat Ion Air Gun Performance

Flow		Air Consumption		Sound Level
PSIG	BAR	SCFM	SLPM	dBa
30	2.1	2.7	76.46	76
80	5.5	5.8	164.21	81

Intellistat Ion Air Nozzle Force / Discharge Time

Pressure Supply		Force*			Discharge Time**	
PSIG	BAR	LBS	OZ	GRAMS	SECONDS	
30	2.1	0.02	0.32	9.1	1.2 sec.	1000V down to 100V
					1.2 sec.	5000V down to 500V
80	5.5	0.1	1.6	45.4	0.6 sec.	1000V down to 100V
					0.6 sec.	5000V down to 500V

* 12" (305mm) from target. **Discharge rate taken from 1" away.

Intellistat Ion Air Gun

Model #	Description
8500	Intellistat Ion Air Gun includes 24VDC Power Supply with Power Cable and 10 feet x 6mm OD compressed air tubing.

Accessories and Components

Model #	Description
9004	Automatic Drain Filter Separator, 1/4 NPT, 43 SCFM (1,218 SLPM)
9008	Pressure Regulator with Gauge, 1/4 NPT, 50 SCFM (1,415 SLPM)
7905	Static Meter
902067	24VDC Power Supply

Intellistat Ion Air Gun Dimensions

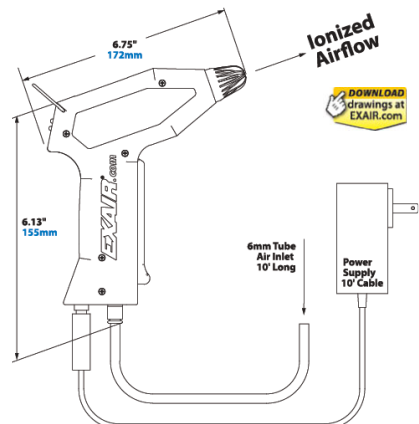



Intellistat® Ion Air Nozzle™

A mountable nozzle for hands free static elimination at assembly stations and benchtop applications!

Rated Class 5 for clean rooms and controlled environments per ISO 14644-1



What is the Intellistat Ion Air Nozzle?

The patent pending Model 8505 Intellistat Ion Air Nozzle is EXAIR's latest hands-free innovation in a long line of static elimination solutions. This intelligent product provides a balanced ionized air stream to neutralize static and remove troublesome particulate during sensitive assembly work, test procedures and clean processes. With a +/-30 volt offset, the Intellistat nozzle was designed to use minimal compressed air while delivering a focused blowoff and exceptional static decay rates capable of reducing 1000 volts to 100 volts in 0.6 seconds. The design includes an efficient, low voltage transformer which converts 120VAC to 24V DC to assure safety. An EXAIR engineered air nozzle delivers the air well below the OSHA standards for noise exposure and dead-end pressure, which maintains safety compliance.

Why the Intellistat Ion Air Nozzle?

Including a compact stainless steel adjustable mounting bracket, the Intellistat nozzle can be mounted to benchtops and machine frames, for example, to provide hands-free operation when needing both hands to package, test or assemble parts and products. The Intellistat Ion Air Nozzle is designed with other convenient features including the 6mm push-in air connection, and green and red LEDs which indicate proper functionality. The housing is made of a durable static dissipative polycarbonate to further minimize any potential for static electricity discharge around sensitive electronics, sensors or materials. The Intellistat Ion Air Nozzle produces an ionized airstream that is essential for removing static, dust, debris and particulate in sterile environments such as pharmaceutical and medical laboratories, clean rooms and electronics labs.

Static Eliminators

Applications

- Precision parts assembly
- Maintain charge neutrality in laboratory processes
- Remove particles from parts and surfaces in clean environments
- PCB manufacturing
- Maintain cleanliness during electronics manufacturing, assembly and testing
- Eliminate electrostatic discharge
- Remove debris from medical products
- Clean lenses, glass containers and slides

Advantages

- Mountable, hands-free operation
- Quick change emitter point
- Rapid static decay
- Low voltage operation
- OSHA safe air outlet and noise level
- LED indicators for proper and improper functionality

Intellistat Ion Air Nozzle

How The Intellistat Ion Air Nozzle Works

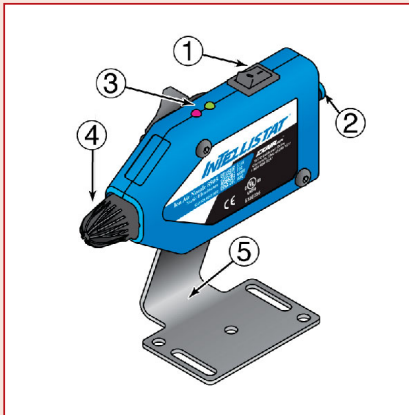

After connecting the 24V power supply, activate the power switch (1) and turn on a compressed source to supply the 6mm push-in fitting (2) to activate the static eliminating ions and airflow. Proper or improper functionality is indicated by a green or red LED (3). The non-marring nozzle (4) provides quiet performance and OSHA compliance. The compact mounting bracket (5) is included to provide hands-free operation.

Static Eliminators

Intellistat Ion Air Nozzle Specifications



Certifications: The Intellistat Ion Air Nozzle is UL listed and CE and RoHS compliant.

Power Supply Input: 100-240VAC — 50/60 Hz 0.7A Max

Power Supply Output: EXAIR Model 902067
Power Supply (24VDC, 1.0A Max) is required for Intellistat Ion Air Nozzle operation. Included with Intellistat Ion Air Nozzle.



Electrical Hazard: Shockless
(less than 40 microamperes short circuited)

Do not use near flammable materials or gases.

Balance: ±30V

Operating Temperature: 32°F to 105°F (0-41°C)

Do not use near flammable materials or gases.

Materials of Construction:

Plastic Parts: Static Resistant Polycarbonate

Emitters: Stainless Steel

Gas Input: 30psig - 125psig

Clean Dry Compressed Air or Nitrogen

Air Connection: 6mm tube

Cleanroom Classification: ISO 14644-1 Class 5, operational.

Intellistat Ion Air Nozzle Performance

Flow		Air Consumption		Sound Level
PSIG	BAR	SCFM	SLPM	dBA
30	2.1	2.7	76.46	76
80	5.5	5.8	164.21	81

Intellistat Ion Air Nozzle Force / Discharge Time

Pressure Supply		Force*			Discharge Time**	
PSIG	BAR	LBS	OZ	GRAMS	SECONDS	
30	2.1	0.02	0.32	9.1	1.2 sec.	1000V down to 100V
					1.2 sec.	5000V down to 500V
80	5.5	0.1	1.6	45.4	0.6 sec.	1000V down to 100V
					0.6 sec.	5000V down to 500V

* 12" (305mm) from target. **Discharge rate taken from 1" away.

Intellistat Ion Air Nozzle

Model #	Description
8505	Intellistat Ion Air Nozzle includes 24VDC Power Supply with Power Cable, 10 feet x 6mm OD compressed air tubing and mounting bracket.

Accessories and Components

Model #	Description
9004	Automatic Drain Filter Separator, 1/4 NPT, 43 SCFM (1,218 SLPM)
9008	Pressure Regulator with Gauge, 1/4 NPT, 50 SCFM (1,415 SLPM)
7905	Static Meter
902067	24VDC Power Supply

Intellistat Ion Air Nozzle Dimensions

