

EASYFILL™

Collection System for Dust from
RECOFIL™ Recovery System

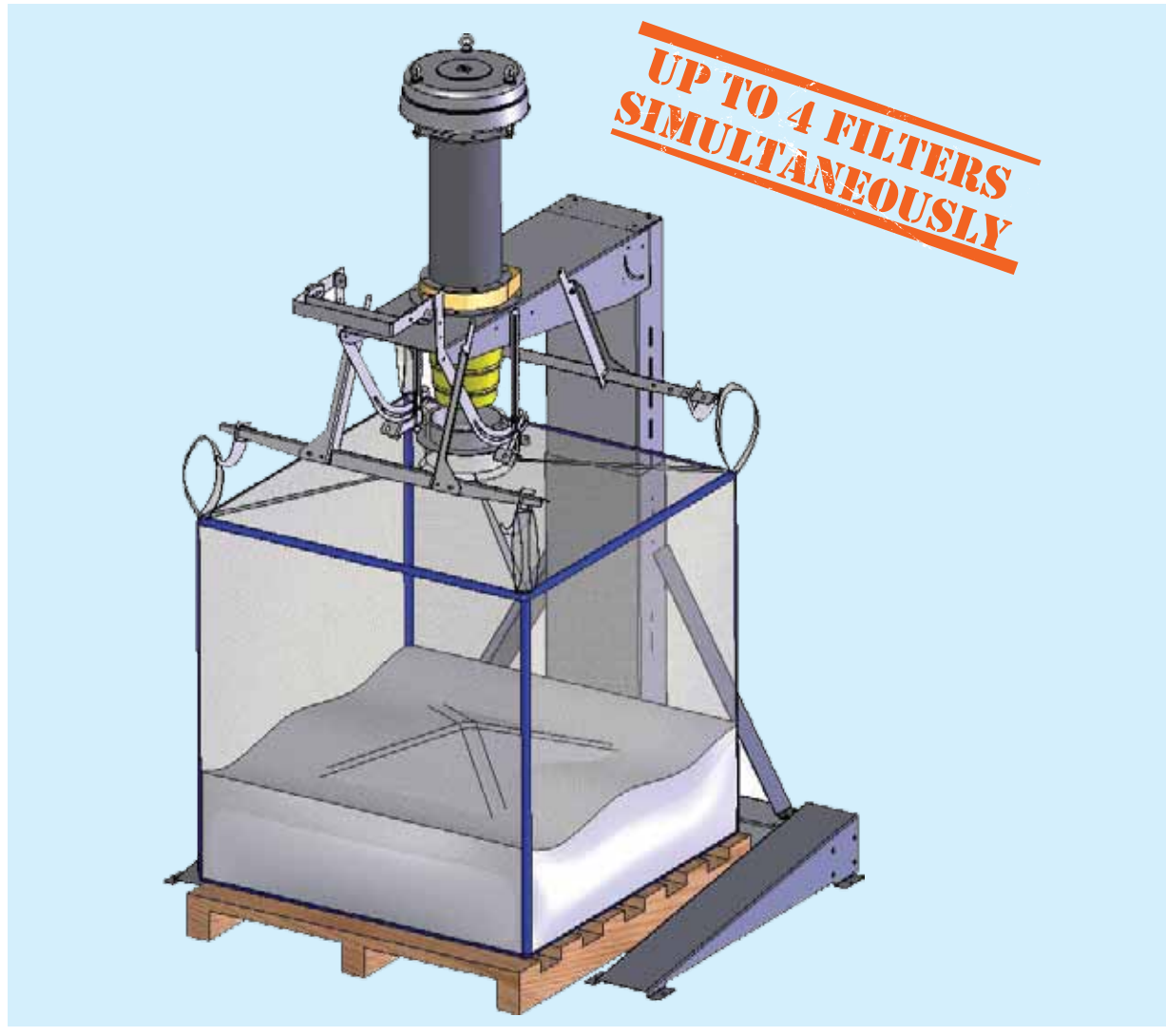
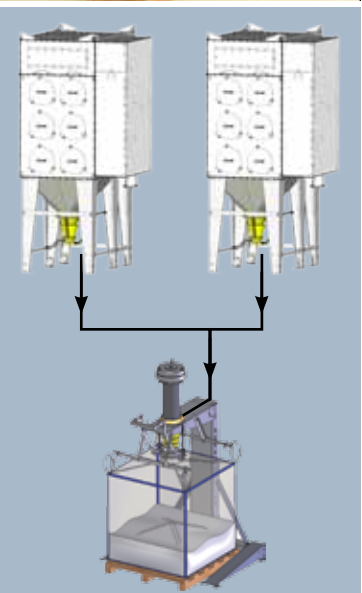
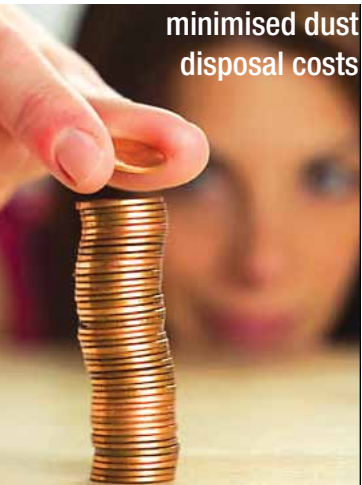

EASYFILL™

Collection System for Dust from
RECOFIL™ Recovery System

EASYFILL™ is a special FIBC Filling System which receives pneumatically conveyed dust simultaneously from up to 4 filters through the RECOFIL™ recovery system.

EASYFILL™ is suitable for various industrial applications which require simple and inexpensive dust disposal.

EASYFILL™, which can be used for different sizes of bulk bags, easily folds up for transport.

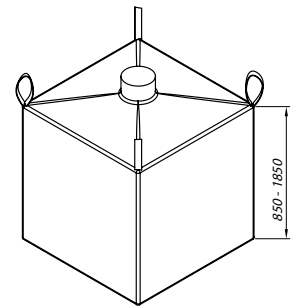
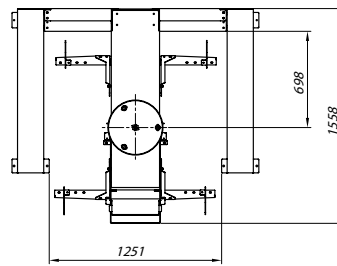
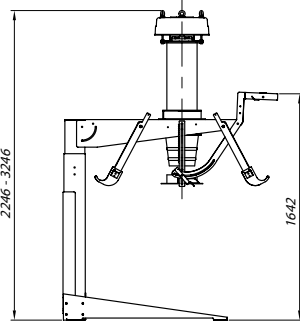
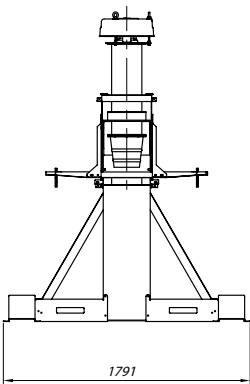

COMPLETE SYSTEM

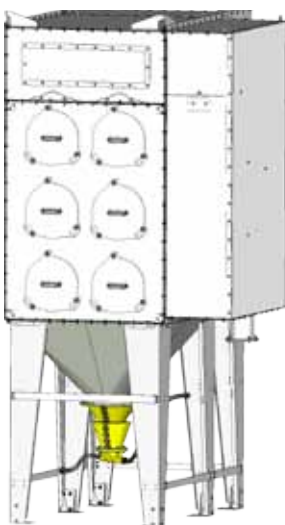

Filter



EASYFILL™



RECOFIL™



PRACTICAL

EASYFILL™ is equipped with a semi-automatic mechanical system enabling quick bulk bag replacement.



ECO-FRIENDLY

EASYFILL™ provides a standard air jet-cleaned cartridge filter which avoids the emission of dust pollutants into the atmosphere protecting the operator and the environment.



VERSATILE

EASYFILL™ is designed for receiving dust from up to 4 filter units equipped with RECOFIL™ recovery system. Costs for dust collection and disposal are reduced to the minimum.

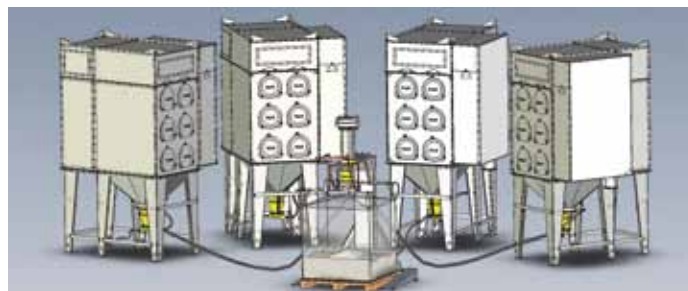

MODULAR

Lightweight and compact EASYFILL™ can be easily stored and transported in a small van. The unit is modular and preassembled requiring less than one hour for commissioning.

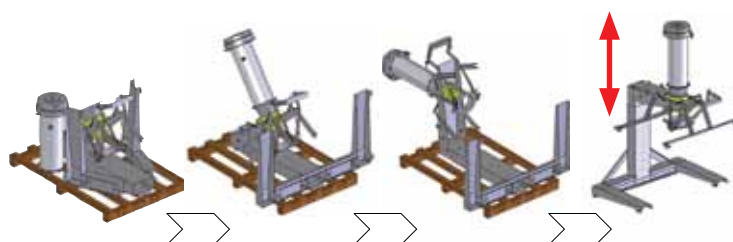

Total weight: 140 kg only
Total packing dimensions: 1,550 x 1,200 x 1,410 mm



Dust collection for disposal from:

- Sheet metal cutting
- Welding
- Sand blasting
- Shot blasting



033001630 September 2012 Rights reserved to modify technical specifications.

