



**SPECIALIST
MACHINERY
SALES**

AUSTRALIA, NEW ZEALAND & SE ASIA

THOUGHT-LEADER IN STEEL PROCESSING AUTOMATION

SUPERIOR MACHINERY SYSTEMS GENERAL OVERVIEW OF CASTELLINI SOLUTION FOR THE APPLICATION OF LASER PROCESS TO THE SHIP BUILDING



1300 262 123 / +61 8 6500 6880



**tellmemore@smsales.com.au
www.SMSales.com.au**





EXECUTIVE SUMMARY

Australia's shipbuilding industry faces multifaceted challenges, from the relentless pace of technological advancement to the fierce competition on the global stage and the ever-evolving landscape of regulatory compliance. To navigate these complexities successfully, industry stakeholders must not only adapt but innovate, seeking out new superior machinery systems that not only address current challenges but also anticipate future needs. In this context, the partnership between Specialist Machinery Sales (SMS) and Castellini Solutions emerges as a beacon of opportunity, offering a strategic alliance that promises to revolutionise the Australian shipbuilding sector.

Castellini Solutions, renowned for its expertise in superior machinery systems tailored specifically for the shipbuilding domain, provides SMS with unparalleled access to state-of-the-art technological solutions. This partnership isn't merely about acquiring machinery; it's about gaining access to a wealth of knowledge, experience, and innovation that can propel SMS to the forefront of the industry. By integrating Castellini's innovative solutions into their operations, SMS stands to achieve significant enhancements in efficiency, productivity, and cost-effectiveness.

Streamlining processes and optimising workflows become not just aspirations but achievable goals, enabling SMS to deliver higher-quality products in less time and at reduced costs. This newfound efficiency isn't just a matter of operational convenience; it's a strategic advantage that can position SMS as a leader in the fiercely competitive global marketplace.

Moreover, Castellini's unwavering commitment to quality and reliability ensures that SMS can navigate the intricate web of regulatory standards with confidence and ease. From stringent safety protocols to exacting environmental regulations, SMS can rest assured that their operations not only meet but exceed the highest industry standards, earning them the trust and respect of customers and regulators alike. Ultimately, this partnership isn't just about individual companies; it's about the collective advancement of the Australian shipbuilding industry as a whole.

“In this transformative partnership, Castellini’s illustrious legacy spanning over 75 years of experience in pioneering machinery and equipment solutions merges seamlessly with Specialist Machinery Sales’ extensive expertise amassed over more than 15 years in the industry. This combined wealth of experience forms the cornerstone of their collaboration, infusing it with a depth of knowledge, insight, and practical know-how that is unparalleled in the market. Drawing upon Castellini’s rich heritage of innovation and Specialist Machinery Sales’ proven track record of customer-centric service, this partnership represents a convergence of the best of both worlds – a fusion of tradition and innovation, experience and agility.”



**SPECIALIST
MACHINERY
SALES** AUSTRALIA, NEW ZEALAND & SE ASIA

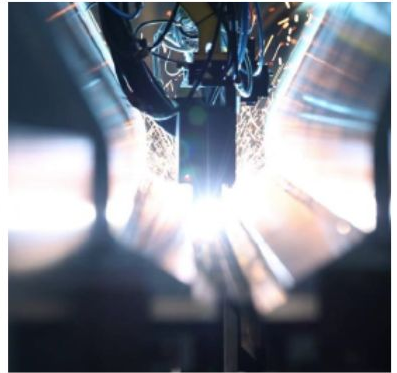
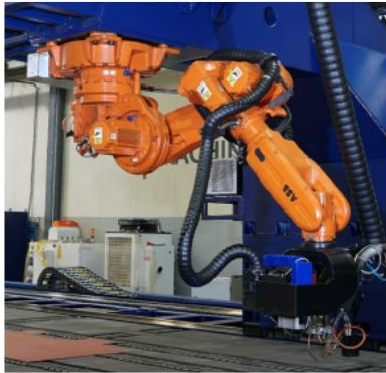



SHIP BUILDING APPLICATION

TECHNICAL FEATURES OF A CASTELLINI PANEL LINE

Fully integrated plant for realising panels for ship decks:

- Optimal application of Laser Technology
- Large sizes: up to 20mt width and no theoretical limits in length
- Thickness: up to 35mm with thickness difference management
- High accuracy and repeatability
- Fully automated production process based on customer drawings
- Integrated material management system(from warehouse to finished products)

**New complete panel line
in production in 2023**





OVERVIEW OF A CASTELLINI PANEL LINE

The panel line can be largely customised. A simple overview of composition of a panel line can be resumed as follows (from left to right):

- **OSW:** One Side Welding
- **CMC:** Cleaning Marking and Cutting
- **SMW:** Stiffeners Mounting and Welding
- **WMW:** Web Mounting and Welding
- **ARW:** Automatic Robot Welding

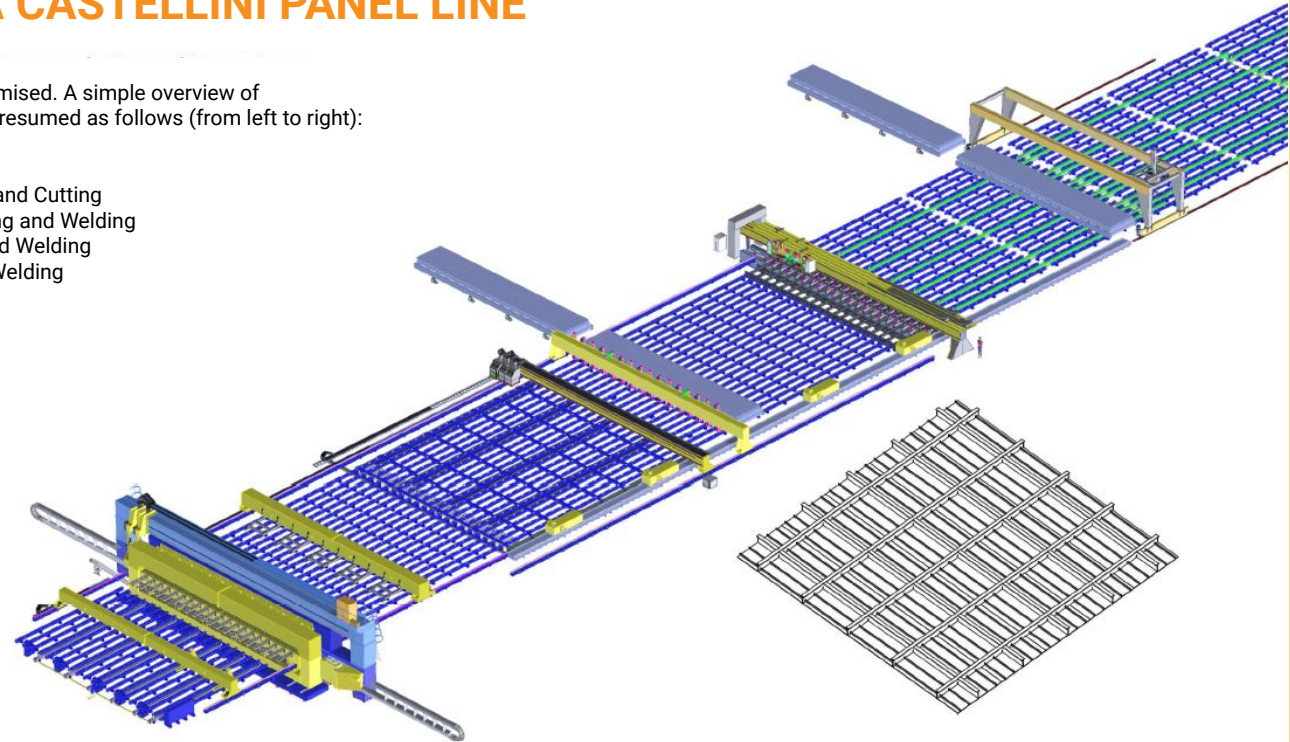



ONE SIDE WELDING (OSW)

Main features of Castellini solution:

- Clean and optimised design
- Laser processing technologies Pure Laser, Cold Wire Laser or HLAW(Hybrid Laser Arc Welding) depending on application
- Different thickness welding
- Patented (patent pending) solution for thickness handling HLAW welding process with integrated edge preparation "upside down" Boring Mill
- Upper or Lower Alignment
- Implementation of the inductor technology for preheating and post heating of the weld seam
- Traditional welding technologies, including Submerged Arc Welding (SAW) available

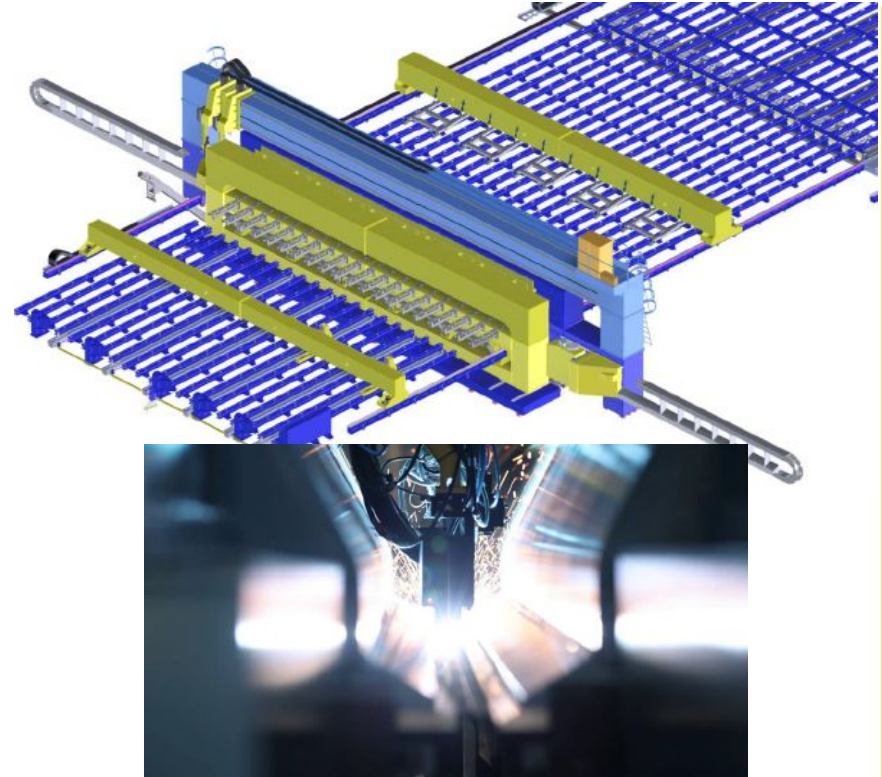



CLEAN MARKING CUTTING (CMC)

Cleaning technology: application of Laser cleaning/decoating Technology (or the traditional Sandblasting) for the complete removal of the primers. Laser application advantages are:

- Clean process (production of reduced quantity of smoke. No sand)
- Faster and more precise process comparing the sandblasting
- Reduced maintenance and wearing of the processing equipment

Marking technology: application of Laser marking (or in jet marking)

Cutting technology: application of Laser Cutting or Plasma Cutting (depending on the thicknesses). Laser has the following advantages comparing the plasma:

- Precise Bevel cut
- Fast and precise process
- Low thermal input, low deformation

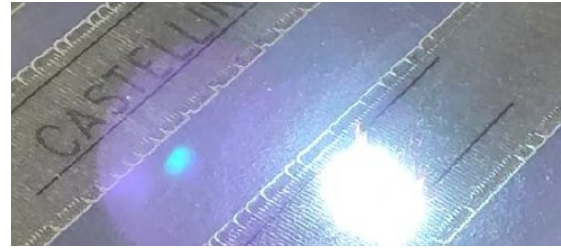



STIFFENERS MOUNTING WELDING (SMW)

Main features of Castellini solution:

- Fully automatic positioning of the Stiffeners, including the counter-pression of the stiffeners to the panel. No need of tack welding.
- Stiffeners dimension up to 500 mm height (T-Beams)
- 2+2 welding heads to reach the productivity
- Different welding technology available according to the need
- Integrated pre-bending and double inductor system to prevent and/or compensate deformation
- Upper alignment with thicknesses differential

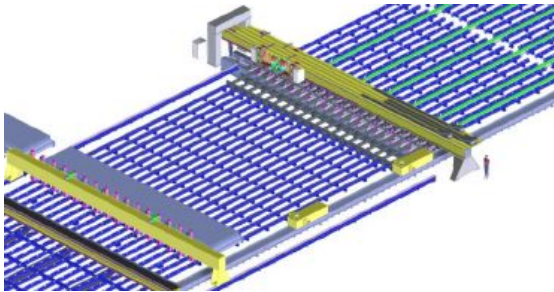



AUTOMATIC ROBOT WELDING (ARW)

The Automatic Robot Welding is designed to reach each corner of the panel including the corners created by the web and stiffeners crossing.

The unit can be equipped with specific software for joint following.

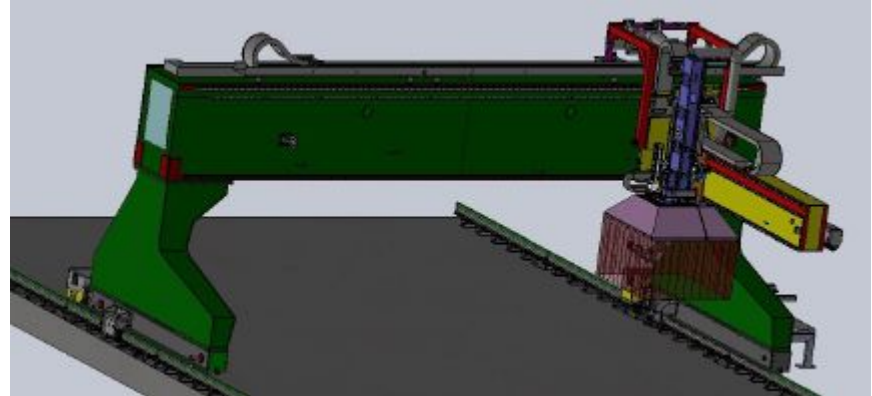

WHY CHOOSE CASTELLINI

Founded in 1949 by Giuseppe Castellini as a mechanical workshop for reconvertng warfare residues for industrial use, over the years the company has undergone several transformations depending on emerging industrial opportunities. By virtue of its continuous investments in human capital, production facilities, and research and development activities, as well as its clear-cut corporate policy, Castellini has evolved into a well-organised company with an expert design and production team, a modern mechanical workshop, and state-of-the-art assembly department.

Nowadays, Castellini is a trusted partner of major steel producers and steelworks constructors but also in the Energy, Hydroelectric, and Shipbuilding sectors.

Sustainability

“Our commitment is to leave to future generations a sustainable and innovative project centred on the ability to adapt itself to the continuous and the increasingly challenging changes.”

Low-impact site

- 30% production area, 70% green area
- Geothermal conditioning
- 40% of energy needs self-generated with solar system 500 kW
- New solar system + 500 kW (end 2024)
- Workshop lighting with natural light
- Attention to work life balance

Social Responsibility

- Continuous support to no profit entities





HISTORY AND FUTURE

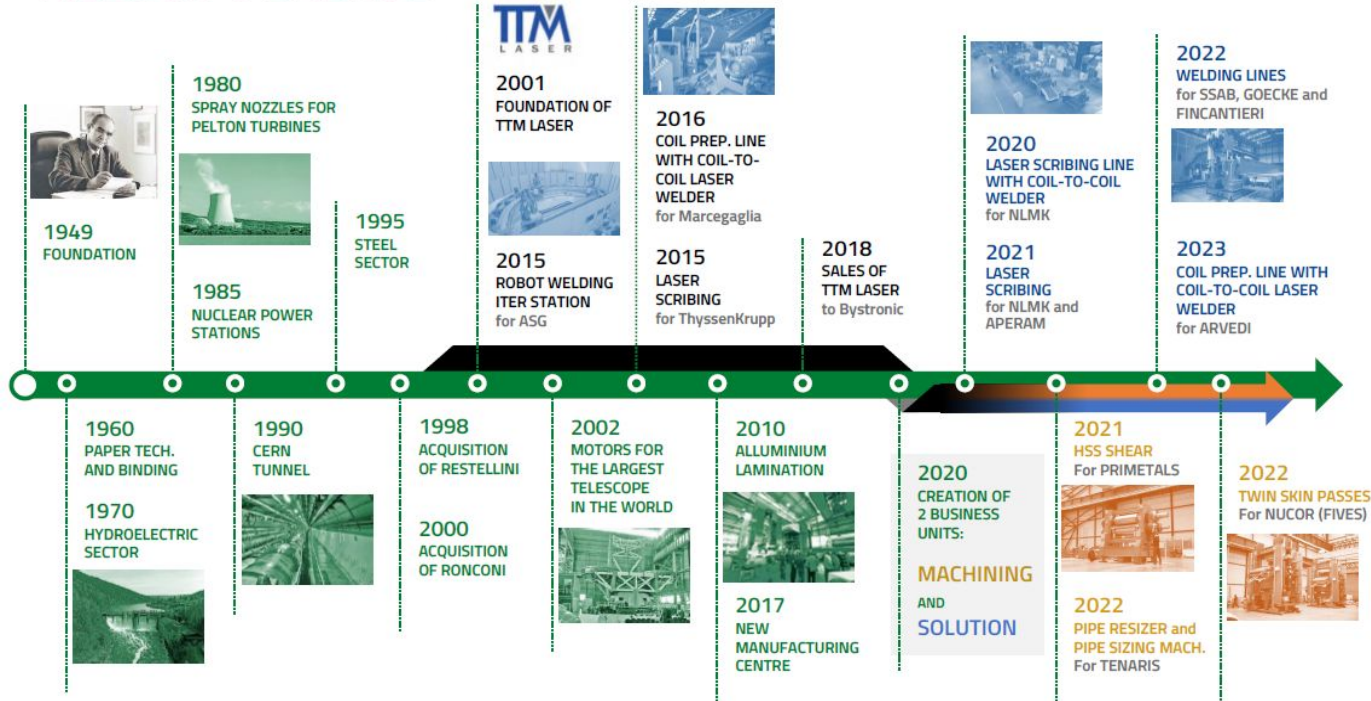



CASTELLINI FACILITY

AREA	62.000 sqm + 10.000 sqm
WORKSHOP	22.000 sqm + 7.500 sqm
OFFICES	3.000 sqm + 800 sqm
MAX. HOISTING CAPACITY	250 tons
HOISTING HEIGHT	17 mt
MAX. BORING FIELD	24 mt
SPECIALTIES	Heavy boring and milling machines / Horizontal and vertical turning lathe / Hydraulic pressure testing rig





MACHINING AND SOLUTION

TWO SOULS, ONE IDENTITY

Machining and Solution are the complementary souls of Castellini that share the same identity, which has been constructed over years of work by virtue of shared experience, values, and objectives.

produces Heavy Machinery
Equipment, High Tech
Rolling Mill Equipment and
Spare Parts for the Metals
Industry of steel and
aluminum

**CASTELLINI
MACHINING**

**CASTELLINI
SOLUTION**

develops technologies and
produces machinery and
plants for specific
applications based on the
Laser Technology, but not
only



THE CASTELLINI SOLUTION APPROACH

DEEPEN INTO TECHNOLOGY FOR A CONTINUOUS IMPROVEMENT OF KNOW HOW

The customers' needs are the driving force of Castellini activities. Castellini solutions are developed in the knowledge that productivity and reliability are always the primary requisites, reachable only through a scientific path.

Following this continuous scientific research of the know how, exploiting the SOLUTION LAB, Castellini is daily developing innovative and performing processes intended for the steel manufacturing world.



ANALYSIS



EXPERIMENTATION AND RESEARCH



DESIGN

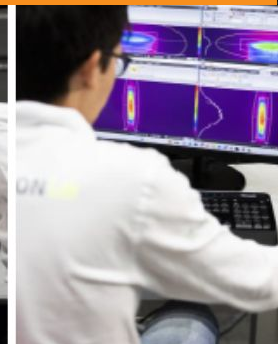



PARTNERSHIPS

THE RIGHT PARTNER LEADS TO A COMMON SUCCESS

Castellini Solution, driven by a strong passion for innovative technologies, cooperates with customers, suppliers, universities and research institutes, conscious that sharing know how is the most important booster to reach successful innovations.

Castellini scientific and technologic main partners are:

FINCANTIERI

DANIELI

RIIA



UNIVERSITÀ
CATTOLICA
del Sacro Cuore



UNIVERSITY
OF BRESCIA

CALEF

IPG
PHOTONICS®



CASTELLINI WORLDWIDE PRESENCE

More than 70% of Castellini turnover comes from international markets. Castellini products are installed in manufacturing plants located all over the world.

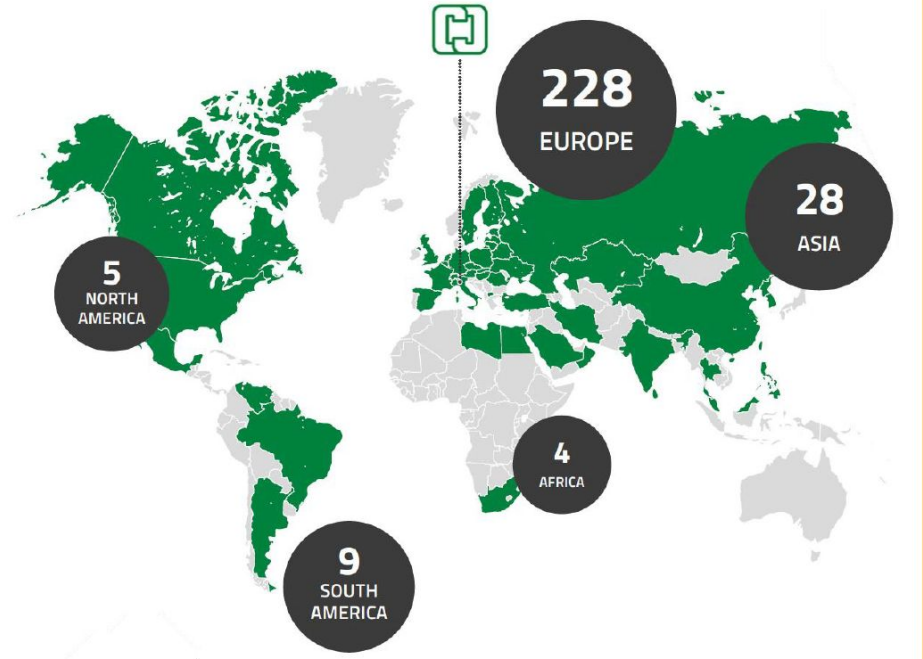



LOOKING TO BUY PRE-LOVED MACHINERY?

Specialist Machinery Sales offer second-hand or used structural steel processing machinery from Kaltenbach, Gietart, Haeusler, SLF and more.

Generally, the machines that SMS has access to are from trading for new machines offered from the machine tool builders to clients of SMS in Australia and New Zealand. Most machines are between 5 and 15 years of age with full-service history available. Some machines can be inspected under power or in their shipping packing ready for immediate delivery to Australasia.

LEARN MORE HERE ►





READY TO SELL YOUR PRE-LOVED MACHINERY?

Selling your pre-loved machinery may appear to be a simple process but it might be more complicated than you think. Selling pre-loved machinery involves equipment liens, resale certificates and financing a buyer. BUT DO NOT WORRY!

Used Structural Machinery (USM) is here to partner with you. At USM, we are your ideal channel to take your equipment and place it in the right hands, with the security and confidence that characterises us. Review our checklist below to help you understand when to retire your machine and how USM can help you sell it off efficiently and effectively.

LEARN MORE HERE ►



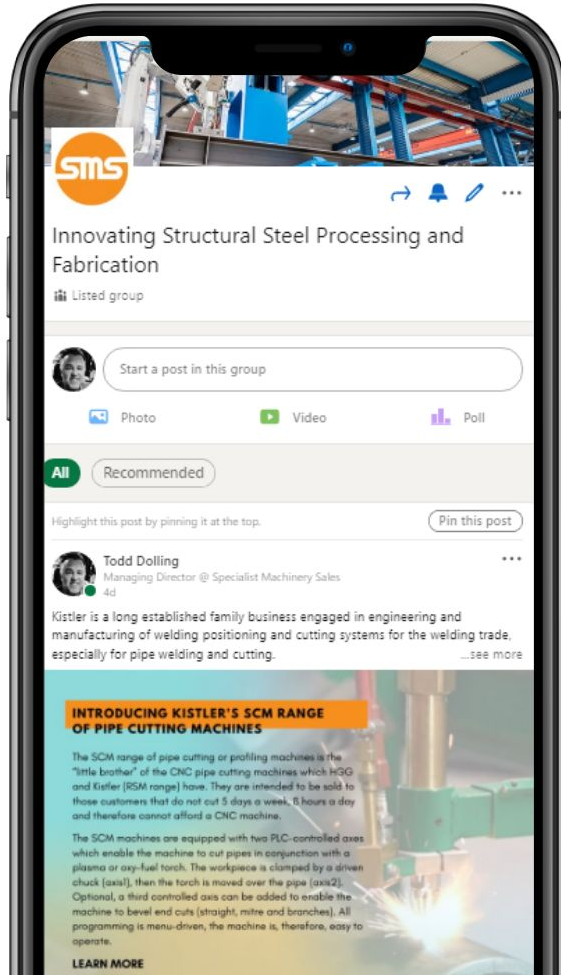

JOIN OUR EXCLUSIVE AND GROWING LINKEDIN GROUP

Join our growing and exclusive LinkedIn Group -
[Innovating Structural Steel Processing and Fabrication Group.](#)

In this group, we bring in thought leadership content, topics, trends and challenges within the steel industry and steel processing automation. We encourage everyone to share your business challenges and solutions that you have encountered and how steel processing automation had helped achieved your business objectives.

JOIN HERE ►



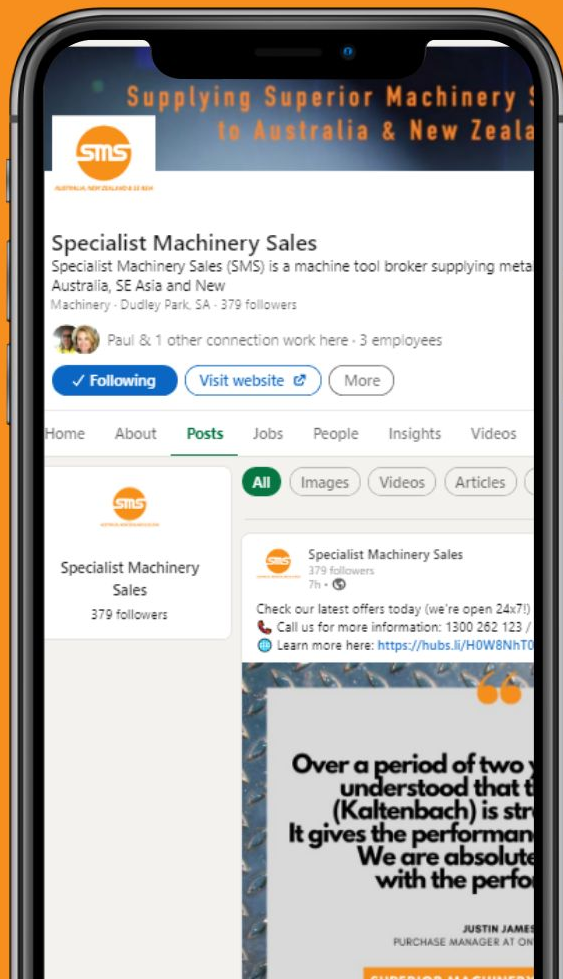

HATE MISSING OUT?

Be the first to receive the latest promotions, new releases and discounted offers by following us on social:





**SPECIALIST
MACHINERY
SALES**

AUSTRALIA, NEW ZEALAND & SE ASIA



1300 262 123 / +61 8 6500 6880



tellmemore@smsales.com.au
www.SMSales.com.au

