



Firex Betterpan
multifunctional cooker

firex
Share the taste

Betterpan

2

Firex

3

Firex

QUALITY IN QUANTITY

The production of quality food in quantity's.

For more than 20 years FIREX has accumulated vast amounts of valuable knowledge for the needs of those in the food service industry, and now also more and more in the food manufacturing industry. From a design stage to product realization, fashioning and forming steel.

FIREX uses their highly creative and skilled team to combine manufacturing and innovative technology methods.

Meeting the demanding quality requirements, with particular emphasis on solidity and functionality. The search for new solutions and continuous implementation of innovative machinery, makes FIREX a market leader.

Forging a new direction in cooking. With a wide range of multifunctional equipment, FIREX raises the bar and elevated every professional kitchen into a high preforming, technological laboratory. Allowing a chefs creativity and food technologist expertises, transform food into delicious dishes.

Staying true to excellent recipes consistently, limitlessly.

In professional kitchens the world over.

The same quality replicated.

Maximum flexibility and multi-task. Various cooking methods in a single equipment.

A host of first-class functions. Guaranteed by Firex.

Betterpan by Firex is the professional bratt pan for the catering industry that offers the possibility of preparing a vast range of recipes using the many cooking modes. Offering the possibility to braise, fry, steam and pressure-cook, Betterpan is the appliance every chef can count on. An asset in the kitchen that lets you utilise your experience and creativity to satisfy high volumes. Endless recipes and all the advantages of an efficient, compact and quality product in a single machine.



Engineered for a versatile kitchen.

Betterpan is a versatile brattpan, with a technological heart. Made entirely from stainless steel, all versions are extremely compact. With the advantage of added accessories for all occasions and expectations. Satisfying even the most demanding chefs.

accessibility of the components
a friendly approach

The components of the equipment are positioned in order to be easily reachable and replaceable, the result of a careful design right down to the most minute detail.



pressure lid*
practical functionality is endless.

The pressure lid in aisi 304 has a double wall, with a food-grade silicone rubber seal. Sealing at a single point allows a total opening of the vessel. The lid is balanced by gas struts for easy opening and closing.

*optional on all models excluding the 220 liter version.

basket-lifting system
the very best at your service.

The system allows the simultaneous lifting of the baskets, to optimise the frying or boiling processes.

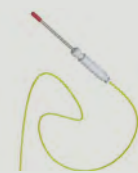

probes
for precision

A first probe is positioned in the base to regulate temperatures between 50 degrees and 250 degrees. A second probe visible in the vessel is in direct contact with the food. This ensures greater control and quick reaction to heat changes. A third probe detects temperature at the core of food while cooking. This probe is optional.

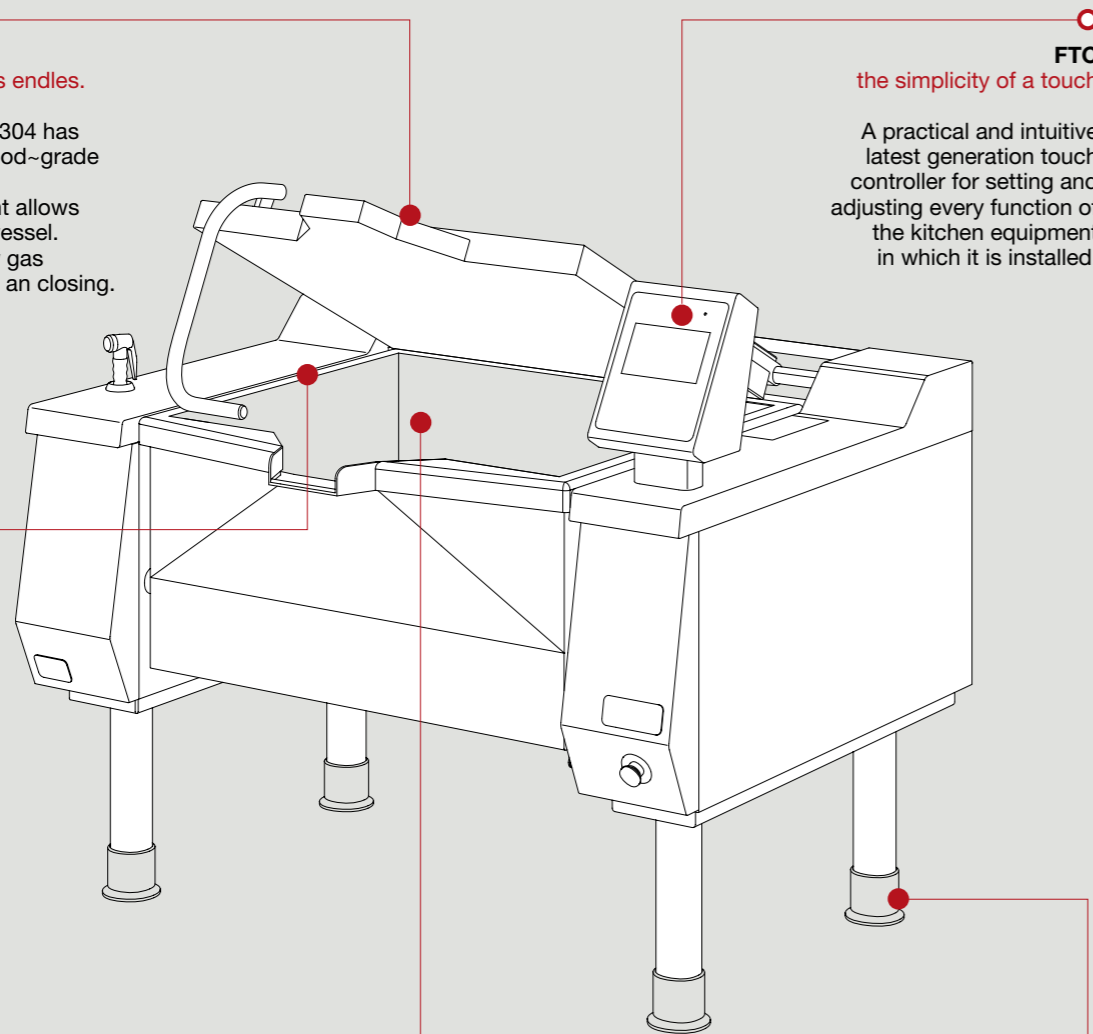

FTC
the simplicity of a touch

A practical and intuitive latest generation touch controller for setting and adjusting every function of the kitchen equipment in which it is installed.

feet
stable support

Height adjustable AISI 304 stainless steel feet for levelling. They are equipped with a removable cover for cleaning operations.

wheels
dynamic practicality

The wheels offer the possibility to move the equipment and to be able to reconfigure the kitchen space according to needs.



pin probe
the precision of a chef

Standard on pressure versions.

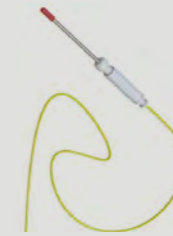

strainer
complete drainage of liquids

Practical help for the separation of the product from the cooking liquids. It fits easily on the upper part of the pan and remains firmly attached to the machine for the complete drainage of liquids.

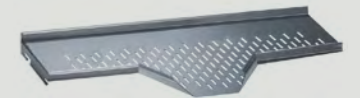

shower head
always on hand

For machine cleaning.



plug socket

For an electrical connection always at hand.



basket-lifting system
integrated basket-lifting system



Many functions, one multipurpose machine.

With Betterpan you can perform all the main types of cooking. You can fry vegetables and meatballs, braise escalopes and fish fillets, cook sauces and omelettes.

With the use of the specific lid, you can pressure-cook stews and risottos, as well as steam legumes and vegetables. Imagination and creativity find their ideal place in the professional kitchen.



The result you expect will surprise you.

From northern Europe to south-east Asia via South America, Betterpan is the spokesperson of a unique food culture in the world. Designed and built entirely in Italy, the bratt pan interprets a new way of cooking for the catering industry by offering chefs in every professional kitchen the possibility of preparing each recipe by replicating the quality and unique taste of each individual preparation. In genuine Italian style.

Some Betterpan applications

- **pasta sauces** : *pressure cooking*
- rice** : *steam cooking*
- chicken** : *boiling*
- escalopes** : *braising*
- cotechino** : *boiling*
- ribs** : *braising*
- meatballs** : *frying*
- stew** : *pressure cooking*
- omelette** : *braising*
- fennels** : *steam cooking*
- potatoes** : *boiling*
- spinach** : *braising*
- carrots** : *boiling*
- legumes** : *pressure cooking*



Programmability and standardisation of the result.

With the FTC (Firex Touch Control) control board, you can set any type of cooking and programme the preparation of the dishes in a few seconds. FTC is simple, intuitive and safe.

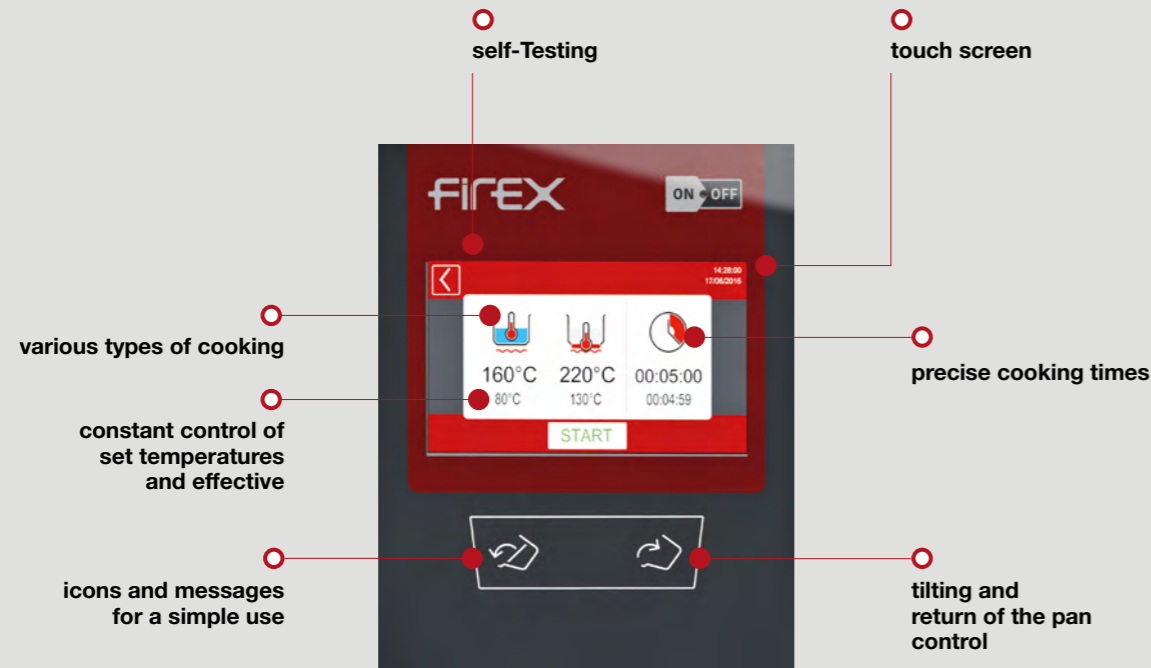

Manufacturing features

- . 7" touch-screen
- . Creation and editing of cooking programmes, each of which is multi-phase
- . Cooking in "Manual" mode
- . Multilingual setting of messages
- . Easy to understand and use
- . It guarantees to set cooking times and extremely precise temperatures from 50°C to 250°C
- . Possibility to choose between various preset cooking methods: boil in water, fry in abundant oil, pressure cooking, brown, or work the product using the core/pin probe for specific processes or even for slow/soft cooking
- . Allows you to select the quantity of litres of water to load, cold or hot up to 90°, and then performs the load

- . automatically It offers 3 different temperature probes: in the bottom, in the pan in contact with the product and the core of the product/pin
- . Allows you to start the cooking process on a specific date and time
- . It can have timed and automatic control of the baskets lifting
- . Displays simple messages and icons for proper and safe use
- . Explains clearly if there is an alarm and to which internal component refers to
- . USB connection
 - . Back up HACCP data
 - . Back up recipes
 - . Software updates
- . Settings of different units of measure
- . Up to 8 different cooking settings
- . Self-Testing
- . Command for tilting and return of the cooking pan.



One product, endless advantages.



Pressure and times.

With Cucimix pressure cooking is possible a significant **reduction in cooking times up to 70%** compared to that of traditional cooking.*

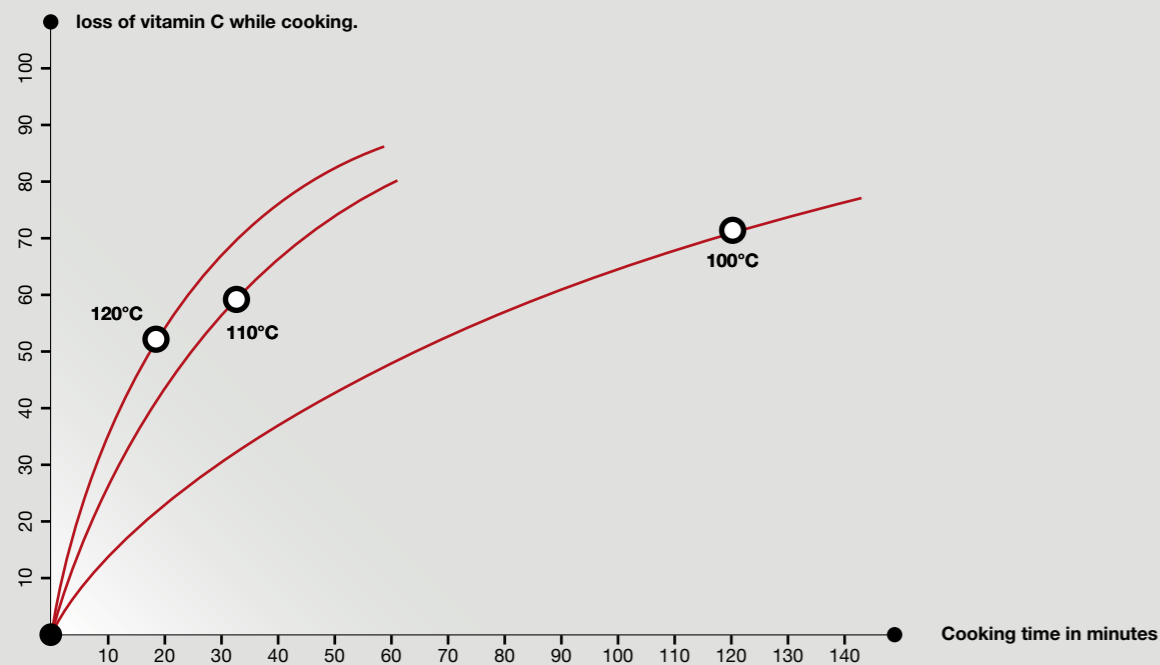

○ Optimal cooking level

01 . Speed and nutrients.

The graph shows that to achieve the same level of cooking is needed 120 minutes for a traditional process at 100°C while using pressure cooking (already at 110°C) times are reduced by about 4 times and that this speed makes possible to maintain more nutrients in the finished product.

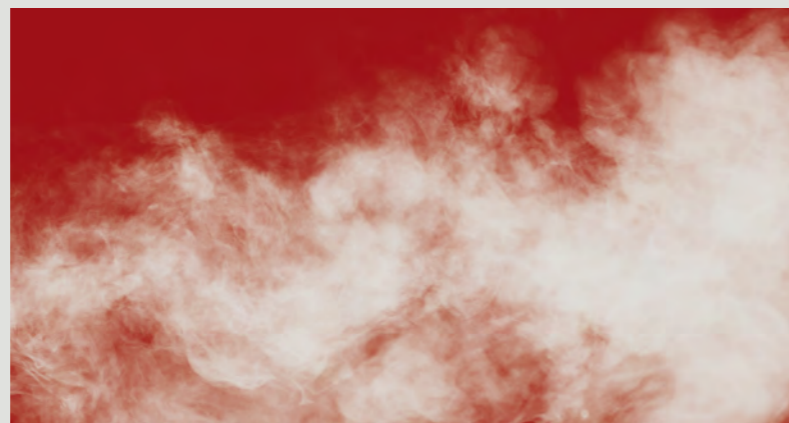

*Broth cooking for Ramen.

Pressure cooking. Cost reduction and increased return.

02 . Processing return.

Up to 30% more compared to traditional cooking, loss of water by evaporation practically avoided in the Cucimix pressure cooking.**

+30%

-62%



-62% **annual costs** (energy, maintenance) compared to traditional pans to get equal production.**

-27%



These advantages have allowed, as has happened to one of our customers, to switch from an array of 5 traditional pans to one of 3 pressure cooking equipment, while maintaining the level of productivity. -27% **installation costs** (machine cost + connection costs, space etc) compared to traditional pans to get equal production.**

-70%



Up to 70% **energy savings** compared to an array of traditional cookers to obtain equal production.**

** Case history McColgan's.



Greater comfort in the work environment.

There is no evaporation of the product in the kitchen during pressure cooking, no dispersion of heat, practically no noise. Everything leads to a healthier work environment.



Easy to clean.

After unloading a product after pressure cooking the pan is practically already clean, it will be enough a quick rinse to start the following cooking cycle.



Better quality of the finished product.

The aromas remain imprisoned in the pan during cooking, these are not dispersed in the environment but they remain in the finished product.



Cooking safety and uniformity.

Working with the pressure cooking Cucimix means working in safety: a series of electronic and mechanical controls guarantees the absolute protection of operators and the surrounding environment. An automatic system hermetically seals the cooking pan only after having detected the absence of residual air. A perfect pressure cooking can only work in container saturated with steam: in this way the temperature in the whole container will be uniform and above 100°C. When the cooking has finished, Cucimix will restore the environmental pressure through a rapid condensation process of the steam and only when the environment is safe, the FTC board signal the possibility of opening the lid.

Perfect heating 2 systems: gas, electric.

Betterpan is available in two versions:
electric or gas.

betterpan DBR 110 . 145 . 180 . 220 litres

Model	dimensions mm.	settings pressure bar	cooking pan				gas version		electrical version	
			dim. pan mm	sup. bottom dm ²	volume total lt	number baskets nr *	power gas Kw	connection electrical V/Hz	power electricity kw	connection electrical V/Hz
DBR 110 V1	1470x1125 h. 1285	0.45	805x650 h. 250	52	110/131	2	28	220-240V 1N 50 Hz	17	380-415V 3N 50/60 Hz
DBR 145 V1	1725x1125 h. 1285	0.45	1060x650 h. 250	69	145/173	3	35	220-240V 1N 50 Hz	20	380-415V 3N 50/60 Hz
DBR 180 V1	2000x1125 h. 1285	0.30	1335x650 h. 250	87	180/217	4	42	220-240V 1N 50 Hz	27	380-415V 3N 50/60 Hz
DBR 220 V1	2255x1560 h. 1285	-	1590x650 h. 250	103	220/258	4	52.5	220-240V 1N 50 Hz	30	380-415V 3N 50/60 Hz

* The 220 litres model does not have a pressure lid

* mod. DBR C

Gas

Heating takes place by means of high-performing stainless steel tubular burners. The ignition and flame monitoring system is automatic, without pilot burner. Heating is controlled by the electronic board with automatic insertion of the minimum at 2°C before the set SETPOINT.

Electric

Heating is controlled by the electronic board of thermocouple system to guarantee a precise detection and a high level reaction speed of the heating system. It takes place through armoured resistances in INCOLOY-800 alloy.

Pressure (A)

The versions with pressure lid allow quick cooking and are equipped with a double opening and closing manoeuvring system for maximum safety. The third probe (pin) is included in the equipment as well as an automatic condensation discharge.

○
DBR



○
DBR.A
with pressure



The quantity you need, in the right doses.

Betterpan is produced in four different capacities, depending on the amount of food to prepare. versions with pressure lid 110 . 145 . 180 litres, without pressure 110. 145 . 180 . 220 litres.

○
DBR.C
with
basket-lifting
system



○
DBR.AC
with pressure
and
basket-lifting
system



○
suspended version





Your Betterpan.

Customise the bratt pan according to your needs, choose the accessories for your Betterpan.



omelette scoop

practical scraper to get perfect omelettes.

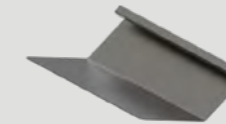

baskets holder trolley

this instrument allows you to load the product in the steaming baskets without burns and in extreme safety.



basket

perforated container for steaming and boiling.



frying basket

container for frying with handle for automatic lifting.

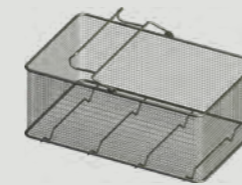

basket holder trolley

practical tool for hooking Gastronorm baskets.





FKL

Firex Kitchen Lab is a space in which we welcome our customers and give them the opportunity to see and test the machines in operation, often reproducing specific recipes. Training courses for chefs, food technologists and pastry chefs are also held in this area. We also held technical courses for the assistance service of our retailers and machine tests by our R&D Department. In a separate room dedicated to show room, all machine models of the range are exposed.

firex
Share the taste



Firex srl

z.i. Gresal, 28 . 32036 Sedico . BL . Italy
t. +39 0437 852700 . f. +39 0437 852858

www.firex.com 

COMPANY WITH
QUALITY SYSTEM
CERTIFIED BY DNV GL
= ISO 9001 =

COMPANY WITH
SAFETY SYSTEM
CERTIFIED BY DNV GL
= OHSAS 18001 =